



737

Airplane Characteristics for Airport Planning



**737 AIRPLANE CHARACTERISTICS
LIST OF ACTIVE PAGES**

Page	Date				
Original 1 to 686	October 2005				

TABLE OF CONTENTS

<u>SECTION</u>	<u>TITLE</u>	<u>PAGE</u>
1.0	SCOPE AND INTRODUCTION	1
1.1	Scope	2
1.2	Introduction	3
1.3	A Brief Description of the 737 Family of Airplanes	4
2.0	AIRPLANE DESCRIPTION	11
2.1	General Characteristics	12
2.2	General Dimensions	28
2.3	Ground Clearances	42
2.4	Interior Arrangements	47
2.5	Cabin Cross-Sections	63
2.6	Lower Cargo Compartments	68
2.7	Door Clearances	73
3.0	AIRPLANE PERFORMANCE	83
3.1	General Information	84
3.2	Payload/Range for Long-Range Cruise	85
3.3	F.A.R. and J.A.R. Takeoff Runway Length Requirements	104
3.4	F.A.R. Landing Runway Length Requirements	270
4.0	GROUND MANEUVERING	317
4.1	General Information	318
4.2	Turning Radii	319
4.3	Minimum Turning Radii - 3-deg Slip Angle	333
4.4	Visibility from Cockpit in Static Position	337
4.5	Runway and Taxiway Turn Paths	338
4.6	Runway Holding Bay	342
5.0	TERMINAL SERVICING	343
5.1	Airplane Servicing Arrangement - Typical Turnaround	345
5.2	Terminal Operations - Turnaround Station	357
5.3	Terminal Operations - En Route Station	366
5.4	Ground Servicing Connections	372
5.5	Engine Start Pneumatic Requirements - Sea Level	387
5.6	Ground Pneumatic Power Requirements – Heating/Cooling	390
5.7	Conditioned Air Flow Requirements	395
5.8	Ground Towing Requirements	400

TABLE OF CONTENTS (CONTINUED)

<u>SECTION</u>	<u>TITLE</u>	<u>PAGE</u>
6.0	JET ENGINE WAKE AND NOISE DATA	403
6.1	Jet Engine Exhaust Velocities and Temperatures	404
6.2	Airport and Community Noise	423
7.0	PAVEMENT DATA	427
7.1	General Information	428
7.2	Landing Gear Footprint	432
7.3	Maximum Pavement Loads	438
7.4	Landing Gear Loading on Pavement	442
7.5	Flexible Pavement Requirements - U.S. Army Corps of Engineers Method (S-77-1)	455
7.6	Flexible Pavement Requirements - LCN Method	462
7.7	Rigid Pavement Requirements - Portland Cement Association Design Method	469
7.8	Rigid Pavement Requirements - LCN Conversion	478
7.9	Rigid Pavement Requirements - FAA Method	486
7.10	ACN/PCN Reporting System - Flexible and Rigid Pavements	493
7.11	Tire Inflation Chart	532
8.0	FUTURE 737 DERIVATIVE AIRPLANES	539
9.0	SCALED 737 DRAWINGS	541

1.0 SCOPE AND INTRODUCTION

1.1 Scope

1.2 Introduction

1.3 A Brief Description of the 737 Family of Airplanes

1.0 SCOPE AND INTRODUCTION

1.1 Scope

This document provides, in a standardized format, airplane characteristics data for general airport planning. Since operational practices vary among airlines, specific data should be coordinated with the using airlines prior to facility design. Boeing Commercial Airplanes should be contacted for any additional information required.

Content of the document reflects the results of a coordinated effort by representatives from the following organizations:

- Aerospace Industries Association
- Airports Council International - North America
- Air Transport Association of America
- International Air Transport Association

The airport planner may also want to consider the information presented in the "Commercial Aircraft Design Characteristics – Trends and Growth Projections," available from the US AIA, 1250 Eye St., Washington DC 20005, for long-range planning needs. This document is updated periodically and represents the coordinated efforts of the following organizations regarding future aircraft growth trends:

- International Coordinating Council of Aerospace Industries Associations
- Airports Council International - North America
- Air Transport Association of America
- International Air Transport Association

1.2 Introduction

This document conforms to NAS 3601. It provides characteristics of the Boeing Model 737 airplanes for airport planners and operators, airlines, architectural and engineering consultant organizations, and other interested industry agencies. Airplane changes and available options may alter model characteristics. The data presented herein reflect typical airplanes in each model category.

For additional information contact:

Boeing Commercial Airplanes
P.O. Box 3707
Seattle, Washington 98124-2207
U.S.A.

Attention: Manager, Airport Technology
Mail Code 67-KR

1.3 A Brief Description of the 737 Family of Airplanes

The 737 is a twin-engine airplane designed to operate over short to medium ranges from sea level runways of less than 6,000 ft (1,830 m) in length.

Significant features of interest to airport planners are described below:

- Underwing-mounted engines provide eye-level assessability. Nearly all system maintenance may be performed at eye level.
- Optional airstairs allow operation at airports where no passengers loading bridges or stairs are available.
- Auxiliary power unit can supply energy for engine starting, air conditioning, and electrical power while the airplane is on the ground or in flight.
- Servicing connections allow single-station pressure fueling and overwing gravity fueling.
- All servicing of the 737 is accomplished with standard ground equipment.

737-100

The 737-100 is the standard short body version of the 737 family. It is 94 ft (28.63 m) long from nose to the tip of the horizontal stabilizer.

737-200

The 737-200 is an extended body version of the 737 family and is 100 ft 2 in (30.53 m) long. Two sections were added to the 737-100 fuselage; a 36-in section forward of the wing and a 40-in section aft of the wing. All other dimensions are the same as the 737-100.

Advanced 737-200

The advanced 737-200 is a high gross weight airplane that has significant improvements over the 737-200, which result in improved performance, e.g. longer range, greater payload, and shorter runway requirement. The advanced 737-200 has dimensions identical to the 737-200.

737-200C, Adv 737-200C

The convertible version differs from the passenger model in that it has an 86 by 134-in (2.18 by 3.40 m) main deck cargo door, increased floor strength, and additional seat tracks. Either of two cargo handling systems, the cargo (C) or quick change (QC) can be installed to allow conversion from a passenger configuration to a cargo or a mixed passenger/cargo configuration, and vice-versa.

737-200 Executive Airplane

The 737-200 and Adv 737-200 were also delivered with an executive interior. The interior comes in a variety of configurations depending on customer requirements. Some airplanes were delivered without any interior furnishings for customer installation of special interiors.

737-300

The 737-300 is a second-generation stretched version of the 737 family of airplanes and is 109 ft 7 in long. Two sections were added to the 737-200 fuselage; a 44-in section forward of the wing and a 60-in section aft of the wing. Wing and stabilizer spans are also increased. The 737-300 incorporates new aerodynamic and engine technologies in addition to the increased payload and range. The -300 can seat as many as 149 passengers in an all-economy configuration.

737-300 With Winglets

Winglets are installed on some 737-300 airplanes as an after-market airline option. Data for this airplane is included for dimensional information only.

737-400

The 737-400 is 120 inches longer than the -300. Two sections were added to the -300 fuselage; a 72-in section forward of the wing and a 48-in section aft of the wing. The -400 can seat as many as 168 passengers in all-economy configuration.

737-500

The 737-500 is the shortened version of the 737-300. The -500 is 101 ft 9 in long and can seat up to 132 passengers in an all-economy configuration.

737-600

The 737-600, along with the 737-700, -800, and -900 is the latest derivative in the 737 family of airplanes. This airplane has the same fuselage as the 737-500 and fitted with new wing, stabilizer, and tail sections. This enables the airplane to fly over longer distances. The 737-600 is 102 ft 6 in long and can carry up to 130 passengers in an all-economy configuration.

737-700

The 737-700 has the same fuselage as the 737-300 and is fitted with the new wing, stabilizer, and tail sections. The 737-700 is 110 ft 4 in long and can carry up to 148 passengers in an all-economy configuration.

737-800

The 737-800 has a slightly longer fuselage than the 737-400 and is fitted with the new wing, stabilizer, and tail sections. The 737-800 is 129 ft 6 in long and can carry up to 184 passengers in an all-economy configuration.

737-900

The 737-900 is a derivative of the -800 and is 96 inches longer than the -800. Two sections were added to the -800 fuselage; a 54-in section forward of the wing and a 42-in section aft of the wing. The -900 can seat as many as 189 passengers in all-economy configuration.

737 BBJ

The Boeing Business Jet is a 737-700 airplane that is delivered without any interior furnishings. The customer installs specific interior configurations. This 737-700 model airplane is equipped with a 737-800 landing gear configuration and has weight and performance capabilities as the -800. One unique feature of the 737 BBJ is the addition of winglets to provide improved cruise performance capabilities.

737 BBJ2

The Boeing Business Jet Two is a 737-800 airplane that is delivered without any interior furnishings. The customer installs specific interior configurations. Like the 737 BBJ, the BBJ2 is equipped with winglets to provide improved cruise performance capabilities.

737-600, -700, -800, -900 With Winglets

The 737-700, -800, and -900 airplanes are also delivered with winglets. Interior configurations are similar to the base airplane models. Like the BBJ airplanes, the winglets provide improved cruise performance capabilities. Winglets are installed on some 737-600 airplanes as an after-market airline option. Data for this airplane is included for dimensional information only.

737-900ER, -900ER With Winglets

The 737-900ER airplanes are long-range derivatives of the 737-900 and -900 with winglets and designed for higher capacity seating. Additional exit doors are installed aft of the wing to provide exit capability for the additional passenger capacity. The 737-900ER and -900ER with winglets are capable of carrying up to 215 passengers with the additional exit doors.

Engines

The 737-100 and -200 airplanes were equipped with JT8D-7 engines. The -9, -5, -17, and -17R engines reflect successive improvements in noise reduction, thrust, and maintenance costs. Other optional engines include the -9A, -15A, -17A, and -17AR.

The 737-300, -400, and -500 airplanes are equipped with new high bypass ratio engines (CFM56-3) that are economical to operate and maintain. These are quiet engines that meet FAR 36 Stage 3 and ICAO Annex 16 Chapter 3 noise standards. With these higher thrust engines and modified flight control surfaces, runway length requirement is reduced.

The 737-600, -700, -800, and -900 airplanes are equipped with advanced derivatives of the 737-300, -400, and -500 engines. These engines (CFM56-7) generate more thrust and exhibit noise characteristics that are below the current noise standards.

737 Gravel Runway Capability

The optional gravel runway capability allows the 737-200 to operate on remote unimproved runways. The gravel kit includes gravel deflectors for the nose and main gears, vortex dissipators for each engine nacelle, and special protective finishes. Low-pressure tires are also required for operation on low strength runways.

The special environment of the gravel runway dictates changes in operating procedures and techniques for maximum safety and economy. Boeing Commercial Airplanes and the FAA have specified procedural changes for operating the 737-200 on gravel runways. Organizations interested in operational details are referred to the using airline or to Boeing.

Passenger Cabin Interiors

Early 737s were equipped with hatrack-type overhead stowage. Later models were equipped with a “wide-body look” interior that incorporates stowage bins in the sidewall and ceiling panels to simulate a superjet interior. More recent configurations include carryall compartments and the advanced technology interior. These interiors provide more stowage above the passenger seats.

Integral Airstairs

Optional airstairs allow passenger loading and unloading at airports where there are no loading bridges or stairs. The forward airstairs are mounted under the cabin floor just below the forward entry door. The aft airstairs are mounted on a special aft entry door and are deployed when the door is opened. The aft airstairs option is available only on the 737-100 and 737-200 airplanes.

Auxiliary Fuel Tanks

Optional auxiliary fuel tanks installed in the lower cargo compartments, provide extra range capability. Although this option increases range, it decreases payload.

Document Page Applicability

Several configurations have been developed for the 737 family of airplanes to meet varied airline requirements. Configurations shown in this document are typical and individual airlines may have different combinations of options. The airlines should be consulted for specific airplane configuration.

Document Applicability

This document contains information on all 737 models.

Information on the 737-100, -200, 200C, Adv 737-200, and Adv 737-200C formerly contained in Document D6-58325, Revision D, 737 Airplane Characteristics for Airport Planning is now included in this document. Document D6-58325 is superseded and should be discarded.

Information on the 737-300, -400, and -500 model airplanes formerly contained in Document D6-58325-2 Revision A, 737-300/400/500 Airplane Characteristics for Airport Planning is now included in this document. Document D6-58325-2 is superseded and should be discarded.

Information on the 737-600, -700, -800, and -900 model airplanes formerly contained in Document D6-58325-3, 737-600/700/800/900 Airplane Characteristics for Airport Planning is now included in this document. Document D6-58325-3 is superseded and should be discarded.

Information on the 737-700, -800, and -900 model airplanes with winglets formerly contained in Document D6-58325-5, 737-700/800/900 (With Winglets) Airplane Characteristics for Airport Planning is now included in this document. Document D6-58325-5 is superseded and should be discarded.

Information on the Boeing Business Jet airplanes formerly contained in Document D6-58325-4, 737-
BBJ Airplane Characteristics for Airport Planning is now included in this document. Document D6-
58325-4 is superseded and should be discarded.

.

THIS PAGE INTENTIONALLY LEFT BLANK

2.0 AIRPLANE DESCRIPTION

2.1 General Characteristics

2.2 General Dimensions

2.3 Ground Clearances

2.4 Interior Arrangements

2.5 Cabin Cross Sections

2.6 Lower Cargo Compartments

2.7 Door Clearances

2.0 AIRPLANE DESCRIPTION

2.1 General Characteristics

Maximum Design Taxi Weight (MTW). Maximum weight for ground maneuver as limited by aircraft strength and airworthiness requirements. (It includes weight of taxi and run-up fuel.)

Maximum Design Takeoff Weight (MTOW). Maximum weight for takeoff as limited by aircraft strength and airworthiness requirements. (This is the maximum weight at start of the takeoff run.)

Maximum Design Landing Weight (MLW). Maximum weight for landing as limited by aircraft strength and airworthiness requirements.

Maximum Design Zero Fuel Weight (MZFW). Maximum weight allowed before usable fuel and other specified usable agents must be loaded in defined sections of the aircraft as limited by strength and airworthiness requirements.

Operating Empty Weight (OEW). Weight of structure, powerplant, furnishing systems, unusable fuel and other unusable propulsion agents, and other items of equipment that are considered an integral part of a particular airplane configuration. Also included are certain standard items, personnel, equipment, and supplies necessary for full operations, excluding usable fuel and payload.

Maximum Payload. Maximum design zero fuel weight minus operational empty weight.

Maximum Seating Capacity. The maximum number of passengers specifically certificated or anticipated for certification.

Maximum Cargo Volume. The maximum space available for cargo.

Usable Fuel. Fuel available for aircraft propulsion.

CHARACTERISTICS	UNITS	MODEL 737-100		
MAX DESIGN TAXI WEIGHT	POUNDS	97,800	104,000	111,000
	KILOGRAMS	44,362	47,174	50,349
MAX DESIGN TAKEOFF WEIGHT	POUNDS	97,000	103,000	110,000
	KILOGRAMS	43,999	46,720	49,896
MAX DESIGN LANDING WEIGHT	POUNDS	89,700	98,000	99,000
	KILOGRAMS	40,688	44,453	44,906
MAX DESIGN ZERO FUEL WEIGHT	POUNDS	81,700	85,000	90,000
	KILOGRAMS	37,059	38,556	40,824
OPERATING EMPTY WEIGHT (1)	POUNDS	58,600	59,000	62,000
	KILOGRAMS	26,581	26,762	28,123
MAX STRUCTURAL PAYLOAD	POUNDS	23,100	26,000	28,000
	KILOGRAMS	10,478	11,794	12,701
SEATING CAPACITY (1)	TWO-CLASS	85: 12 FIRST CLASS AND 73 ECONOMY		
	ALL-ECONOMY	96 AT SIX ABREAST; FAA EXIT LIMIT: 124		
MAX CARGO VOLUME - LOWER DECK	CUBIC FEET	650	650	650
	CUBIC METERS	18.4	18.4	18.4
USABLE FUEL	US GALLONS	3,540	3,540	4,720
	LITERS	13,399	13,399	17,865
	POUNDS	23,718	23,718	31,624
	KILOGRAMS	10,758	10,758	14,345

NOTE: (1) OPERATING EMPTY WEIGHT FOR BASELINE MIXED CLASS CONFIGURATION.
CONSULT WITH AIRLINE FOR SPECIFIC WEIGHTS AND CONFIGURATIONS.

2.1.1 GENERAL CHARACTERISTICS

MODEL 737-100

CHARACTERISTICS	UNITS	MODEL 737-200				
MAX DESIGN TAXI WEIGHT	POUNDS	100,800	104,000	110,000	111,000	116,000
	KILOGRAMS	45,723	47,174	49,896	50,349	52,617
MAX DESIGN TAKEOFF WEIGHT	POUNDS	100,000	103,000	109,000	110,000	115,500
	KILOGRAMS	45,360	46,720	49,442	49,896	52,390
MAX DESIGN LANDING WEIGHT	POUNDS	95,000	95,000	98,000	99,000	103,000
	KILOGRAMS	43,092	43,092	44,453	44,906	46,720
MAX DESIGN ZERO FUEL WEIGHT	POUNDS	85,000	85,000	88,000	92,000	95,000
	KILOGRAMS	38,556	38,556	39,917	41,731	43,092
OPERATING EMPTY WEIGHT (1)	POUNDS	59,900	60,900	60,800	61,800	59,800
	KILOGRAMS	27,170	27,624	27,579	28,032	27,125
MAX STRUCTURAL PAYLOAD	POUNDS	25,100	24,100	27,200	30,200	35,200
	KILOGRAMS	11,385	10,932	12,338	13,699	15,967
SEATING CAPACITY (1)	TWO-CLASS	97: 24 FIRST CLASS AND 73 ECONOMY				
	ALL-ECONOMY	90 AT FIVE ABREAST, OR 124 AT SIX ABREAST; FAA EXIT LIMIT: 136				
MAX CARGO VOLUME - LOWER DECK	CUBIC FEET	875	875	875	875	875
	CUBIC METERS	24.8	24.8	24.8	24.8	24.8
USABLE FUEL	US GALLONS	3,460	4,190	4,230	4,780	4,780
	LITERS	13,096	15,859	16,011	18,092	18,092
	POUNDS	23,182	28,073	28,341	32,026	32,026
	KILOGRAMS	10,515	12,734	12,855	14,527	14,527

NOTE: (1) OPERATING EMPTY WEIGHT FOR BASELINE MIXED CLASS CONFIGURATION.
CONSULT WITH AIRLINE FOR SPECIFIC WEIGHTS AND CONFIGURATIONS.

2.1.2 GENERAL CHARACTERISTICS

MODEL 737-200

D6-58325-6

14 OCTOBER 2005

CHARACTERISTICS	UNITS	MODEL 737-200				
		CONVERTIBLE				EXECUTIVE
MAX DESIGN TAXI WEIGHT	POUNDS	110,000	111,000	111,000	116,000	116,000
	KILOGRAMS	49,896	50,349	50,349	52,617	52,617
MAX DESIGN TAKEOFF WEIGHT	POUNDS	109,000	110,000	110,000	115,500	115,500
	KILOGRAMS	49,442	49,896	49,896	52,390	52,390
MAX DESIGN LANDING WEIGHT	POUNDS	98,000	99,000	103,000	103,000	103,000
	KILOGRAMS	44,453	44,906	46,720	46,720	46,720
MAX DESIGN ZERO FUEL WEIGHT	POUNDS	88,000	92,000	95,000	95,000	95,000
	KILOGRAMS	39,917	41,731	43,092	43,092	43,092
OPERATING EMPTY WEIGHT (1)	POUNDS	61,100	64,900	69,700	66,800	54,900
	KILOGRAMS	27,715	29,438	31,616	30,300	24,902
MAX STRUCTURAL PAYLOAD	POUNDS	26,900	27,100	25,300	28,200	40,100
	KILOGRAMS	12,202	12,292	11,476	12,791	18,189
SEATING CAPACITY	TWO-CLASS	110: 8 FIRST CLASS AND 102 ECONOMY (2)				EXECUTIVE INTERIOR VARIES WITH CUSTOMER OPTION
	ALL-ECONOMY	117 AT SIX ABREAST (2) ; FAA EXIT LIMIT: 136				
MAX CARGO VOLUME - MAIN DECK	CUBIC FEET	2,760 (3)	2,760 (3)	2,760 (3)	2,760 (3)	EXECUTIVE INTERIOR VARIES WITH CUSTOMER OPTION
	CUBIC METERS	78.2 (3)	78.2 (3)	78.2 (3)	78.2 (3)	
MAX CARGO VOLUME - LOWER DECK	CUBIC FEET	875	875	875	875	875
	CUBIC METERS	24.8	24.8	24.8	24.8	24.8
USABLE FUEL	US GALLONS	4,200	4,750	3,500	4,780	4,720
	LITERS	15,897	17,979	13,248	18,092	17,865
	POUNDS	28,140	31,825	23,450	32,026	31,624
	KILOGRAMS	12,764	14,436	10,637	14,527	14,345

- NOTES: (1) OPERATING EMPTY WEIGHT FOR BASELINE MIXED CLASS CONFIGURATION. CONSULT WITH AIRLINE FOR SPECIFIC WEIGHTS AND CONFIGURATIONS.
- (2) AIRPLANE IN ALL-PASSENGER CONFIGURATION
- (3) AIRPLANE IN ALL-CARGO CONFIGURATION WITH THE "QC" CARGO SYSTEM
88 x 125 IN (2.24 x 3.18 M) PALLETS

2.1.3 GENERAL CHARACTERISTICS

MODEL 737-200, CONVERTIBLE AND EXECUTIVE AIRPLANES

CHARACTERISTICS	UNITS	MODEL ADVANCED 737-200				
MAX DESIGN TAXI WEIGHT	POUNDS	116,000	117,500	120,000	125,000	128,600
	KILOGRAMS	52,617	53,298	54,432	56,700	58,333
MAX DESIGN TAKEOFF WEIGHT	POUNDS	115,500	117,000	119,500	124,500	128,100
	KILOGRAMS	52,390	53,071	54,205	56,473	58,106
MAX DESIGN LANDING WEIGHT	POUNDS	103,000	105,000	105,000	107,000	107,000
	KILOGRAMS	46,720	47,628	47,628	48,535	48,535
MAX DESIGN ZERO FUEL WEIGHT	POUNDS	95,000	95,000	95,000	95,000	95,000
	KILOGRAMS	43,092	43,092	43,092	43,092	43,092
OPERATING EMPTY WEIGHT (1)	POUNDS	62,600	64,500	63,100	63,900	65,300
	KILOGRAMS	28,395	29,257	28,622	28,985	29,620
MAX STRUCTURAL PAYLOAD	POUNDS	32,400	30,500	31,900	31,100	29,700
	KILOGRAMS	14,697	13,835	14,470	14,107	13,472
SEATING CAPACITY (1)	TWO-CLASS	102: 14 FIRST CLASS AND 88 ECONOMY				
	ALL-ECONOMY	93 AT FIVE ABREAST, OR 130 AT SIX ABREAST; FAA EXIT LIMIT: 136				
MAX CARGO VOLUME - LOWER DECK	CUBIC FEET	875	875	875	745 (2)	640 (3)
	CUBIC METERS	24.8	24.8	24.8	21.1 (2)	18.1 (3)
USABLE FUEL	US GALLONS	5,160	5,160	5,160	5,550 (2)	5,970 (3)
	LITERS	19,531	19,531	19,531	21,007 (2)	22,596 (3)
	POUNDS	34,572	34,572	34,572	37,185 (2)	39,999 (3)
	KILOGRAMS	15,682	15,682	15,682	16,867 (2)	18,143 (3)

- NOTES: (1) OPERATING EMPTY WEIGHT FOR BASELINE MIXED CLASS CONFIGURATION. CONSULT WITH AIRLINE FOR SPECIFIC WEIGHTS AND CONFIGURATIONS.
(2) AIRPLANE WITH 390 GAL (1,475 L) AUXILIARY FUEL TANK IN AFT CARGO COMPARTMENT
(3) AIRPLANE WITH 810 GAL (3,065 L) AUXILIARY FUEL TANK IN AFT CARGO COMPARTMENT

2.1.4 GENERAL CHARACTERISTICS

MODEL ADVANCED 737-200

D6-58325-6

16 OCTOBER 2005

CHARACTERISTICS	UNITS	MODEL ADVANCED 737-200C, -200QC				
MAX DESIGN TAXI WEIGHT	POUNDS	116,000	117,500	120,000	125,000	128,600
	KILOGRAMS	52,617	53,298	54,432	56,700	58,333
MAX DESIGN TAKEOFF WEIGHT	POUNDS	115,500	117,000	119,500	124,500	128,100
	KILOGRAMS	52,390	53,071	54,205	56,473	58,106
MAX DESIGN LANDING WEIGHT	POUNDS	103,000	105,000	105,000	107,000	107,000
	KILOGRAMS	46,720	47,628	47,628	48,535	48,535
MAX DESIGN ZERO FUEL WEIGHT	POUNDS	95,000	96,500	95,000	99,000	99,000
	KILOGRAMS	43,092	43,772	43,092	44,906	44,906
OPERATING EMPTY WEIGHT (1)	POUNDS	65,700	69,800	66,500	67,000	65,700
	KILOGRAMS	29,801	31,661	30,164	30,391	29,801
MAX STRUCTURAL PAYLOAD	POUNDS	29,300	26,700	28,500	32,000	33,300
	KILOGRAMS	13,290	12,111	12,928	14,515	15,105
SEATING CAPACITY (2)	TWO-CLASS	102: 14 FIRST CLASS AND 88 ECONOMY				
	ALL-ECONOMY	93 AT FIVE ABREAST, OR 130 AT SIX ABREAST; FAA EXIT LIMIT: 136				
MAX CARGO VOLUME - MAIN DECK (3)	CUBIC FEET	2,760	2,760	2,760	2,760	2,760
	CUBIC METERS	78.2	78.2	78.2	78.2	78.2
MAX CARGO VOLUME - LOWER DECK	CUBIC FEET	875	875	875	875	875
	CUBIC METERS	24.8	24.8	24.8	24.8	24.8
USABLE FUEL	US GALLONS	5,160	5,160	5,160	5,160	5,160
	LITERS	19,531	19,531	19,531	19,531	19,531
	POUNDS	34,572	34,572	34,572	34,572	34,572
	KILOGRAMS	15,682	15,682	15,682	15,682	15,682

- NOTES: (1) OPERATING EMPTY WEIGHT FOR BASELINE MIXED CLASS CONFIGURATION. CONSULT WITH AIRLINE FOR SPECIFIC WEIGHTS AND CONFIGURATIONS.
(2) AIRPLANE IN ALL-PASSENGER CONFIGURATION
(3) AIRPLANE IN ALL-CARGO CONFIGURATION, SEVEN PALLETS 88 x 125 IN (2.24 x 3.18 M) EACH

2.1.5 GENERAL CHARACTERISTICS
MODEL ADVANCED 737-200C, -200QC

CHARACTERISTICS	UNITS	MODEL 737-300					
		CFM56-3B1 ENGINES (20,000 LB SLST)			CFM56-3B2 ENGINES (22,000 LB SLST)		
MAX DESIGN TAXI WEIGHT	POUNDS	125,000	130,500	135,500	137,500	139,000	140,000
	KILOGRAMS	56,700	59,194	61,462	63,050	63,504	63,504
MAX DESIGN TAKEOFF WEIGHT	POUNDS	124,500	130,000	135,000	137,000	139,500	139,500
	KILOGRAMS	56,473	58,968	61,236	62,823	63,277	63,277
MAX DESIGN LANDING WEIGHT	POUNDS	114,000	114,000	114,000	114,000	115,800	115,800
	KILOGRAMS	51,710	51,710	51,710	51,710	52,527	52,527
MAX DESIGN ZERO FUEL WEIGHT	POUNDS	105,000	105,000	106,500	106,500	106,500	106,500
	KILOGRAMS	47,628	47,628	48,308	48,308	48,308	48,308
OPERATING EMPTY WEIGHT (1)	POUNDS	69,400	71,870	72,540	72,540	72,540	72,540
	KILOGRAMS	31,480	32,600	32,904	32,904	32,904	32,904
MAX STRUCTURAL PAYLOAD	POUNDS	35,600	33,130	33,960	33,960	33,960	33,960
	KILOGRAMS	16,148	15,028	15,404	15,404	15,404	15,404
SEATING CAPACITY	TWO-CLASS	128: 8 FIRST CLASS AND 120 ECONOMY					
	ALL-ECONOMY	134 AT SIX ABREAST; FAA EXIT LIMIT: 149					
MAX CARGO VOLUME - LOWER DECK	CUBIC FEET	1,068	929 (2)	841 (3)	917 (4)	792 (5)	792 (5)
	CUBIC METERS	30.2	26.3 (2)	23.8 (3)	26.0 (4)	22.4 (5)	22.4 (5)
USABLE FUEL	US GALLONS	5,311	5,701 (2)	6,121 (3)	5,803 (4)	6,295 (5)	6,295 (5)
	LITERS	20,102	21,578 (2)	23,168 (3)	21,964 (4)	23,827 (5)	23,827 (5)
	POUNDS	35,584	38,197 (2)	41,011 (3)	38,880 (4)	42,177 (5)	42,177 (5)
	KILOGRAMS	16,141	17,326 (2)	18,602 (3)	17,636 (4)	19,131 (5)	19,131 (5)

- NOTES: (1) OPERATING EMPTY WEIGHT FOR BASELINE MIXED CLASS CONFIGURATION. CONSULT WITH AIRLINE FOR SPECIFIC WEIGHTS AND CONFIGURATIONS.
- (2) AIRPLANE WITH 390 GAL (1,475 L) AUXILIARY FUEL TANK IN AFT CARGO COMPARTMENT
- (3) AIRPLANE WITH 810 GAL (3,065 L) AUXILIARY FUEL TANK IN AFT CARGO COMPARTMENT
- (4) AIRPLANE WITH 500 GAL (1,893 L) AUXILIARY FUEL TANK IN AFT CARGO COMPARTMENT
- (5) AIRPLANE WITH 1,000 GAL (3,785 L) AUXILIARY FUEL TANK IN AFT CARGO COMPARTMENT

2.1.6 GENERAL CHARACTERISTICS

MODEL 737-300

D6-58325-6

18 OCTOBER 2005

CHARACTERISTICS	UNITS	MODEL 737-400					
		CFM56-3B2 ENGINES (22,000 LB SLST)			CFM56-3C ENGINES (23,500 LB SLST)		
MAX DESIGN	POUNDS	139,000	143,000	150,500	143,000	144,000	150,500
TAXI WEIGHT	KILOGRAMS	63,049	64,864	68,266	64,864	65,317	68,266
MAX DESIGN	POUNDS	138,500	142,500	150,000	142,500	143,500	150,000
TAKEOFF WEIGHT	KILOGRAMS	62,823	64,637	68,039	64,637	65,091	68,039
MAX DESIGN	POUNDS	121,000	121,000	124,000	124,000	124,000	124,000
LANDING WEIGHT	KILOGRAMS	54,885	54,885	56,246	56,246	56,246	56,246
MAX DESIGN	POUNDS	113,000	113,000	117,000	117,000	117,000	117,000
ZERO FUEL WEIGHT	KILOGRAMS	51,256	51,256	53,070	53,070	53,070	53,070
OPERATING	POUNDS	73,170	73,170	73,170	74,170	74,170	74,170
EMPTY WEIGHT (1)	KILOGRAMS	33,189	33,189	33,189	33,643	33,643	33,643
MAX STRUCTURAL	POUNDS	39,830	39,830	43,830	42,830	42,830	42,830
PAYLOAD	KILOGRAMS	18,067	18,067	19,881	19,427	19,427	19,427
SEATING CAPACITY	TWO-CLASS	146: 8 FIRST CLASS AND 138 ECONOMY					
	ALL-ECONOMY	159 AT SIX ABREAST; FAA EXIT LIMIT: 189					
MAX CARGO VOLUME	CUBIC FEET	1,373	1,234 (2)	1,146 (3)	1,222 (4)	1,097 (5)	1,097 (5)
- LOWER DECK	CUBIC METERS	38.9	34.9 (2)	32.5 (3)	34.6 (4)	31.1 (5)	31.1 (5)
USABLE FUEL	US GALLONS	5,311	5,701 (2)	6,121 (3)	5,803 (4)	6,295 (5)	6,295 (5)
	LITERS	20,102	21,578 (2)	23,168 (3)	21,964 (4)	23,827 (5)	23,827 (5)
	POUNDS	35,584	38,197 (2)	41,011 (3)	38,880 (4)	42,177 (5)	42,177 (5)
	KILOGRAMS	16,141	17,326 (2)	18,602 (3)	17,636 (4)	19,131 (5)	19,131 (5)

- NOTES: (1) OPERATING EMPTY WEIGHT FOR BASELINE MIXED CLASS CONFIGURATION. CONSULT WITH AIRLINE FOR SPECIFIC WEIGHTS AND CONFIGURATIONS.
- (2) AIRPLANE WITH 390 GAL (1,475 L) AUXILIARY FUEL TANK IN AFT CARGO COMPARTMENT
- (3) AIRPLANE WITH 810 GAL (3,065 L) AUXILIARY FUEL TANK IN AFT CARGO COMPARTMENT
- (4) AIRPLANE WITH 500 GAL (1,893 L) AUXILIARY FUEL TANK IN AFT CARGO COMPARTMENT
- (5) AIRPLANE WITH 1,000 GAL (3,785 L) AUXILIARY FUEL TANK IN AFT CARGO COMPARTMENT

2.1.7 GENERAL CHARACTERISTICS

MODEL 737-400

D6-58325-6

OCTOBER 2005 19

CHARACTERISTICS	UNITS	MODEL 737-500				
		CFM56-3B1 ENGINES (18,500 LB SLST)			CFM56-3B1 ENGINES (20,000 LB SLST)	
MAX DESIGN TAXI WEIGHT	POUNDS	116,000	125,000	134,000	125,000	136,500
	KILOGRAMS	52,617	56,699	60,781	56,699	61,915
MAX DESIGN TAKEOFF WEIGHT	POUNDS	115,500	124,500	133,500	133,500	136,000
	KILOGRAMS	52,390	56,472	60,555	60,555	61,689
MAX DESIGN LANDING WEIGHT	POUNDS	110,000	110,000	110,000	110,000	110,000
	KILOGRAMS	49,895	49,895	49,895	49,895	49,895
MAX DESIGN ZERO FUEL WEIGHT	POUNDS	102,500	102,500	102,500	102,500	103,000
	KILOGRAMS	46,493	46,493	46,493	46,493	46,720
OPERATING EMPTY WEIGHT (1)	POUNDS	69,030	69,030	69,030	69,030	69,030
	KILOGRAMS	31,312	31,312	31,312	31,312	31,312
MAX STRUCTURAL PAYLOAD	POUNDS	33,470	33,470	33,470	33,470	33,470
	KILOGRAMS	15,182	15,182	15,182	15,182	15,182
SEATING CAPACITY	TWO-CLASS	108: 8 FIRST CLASS AND 100 ECONOMY				
	ALL-ECONOMY	122 AT SIX ABREAST; FAA EXIT LIMIT: 149				
MAX CARGO VOLUME - LOWER DECK	CUBIC FEET	822	683 (2)	595 (3)	671 (4)	546 (5)
	CUBIC METERS	23.3	19.3 (2)	16.8 (3)	19.0 (4)	15.5 (5)
USABLE FUEL	US GALLONS	5,311	5,701 (2)	6,121 (3)	5,803 (4)	6,295 (5)
	LITERS	20,102	21,578 (2)	23,168 (3)	21,964 (4)	23,827 (5)
	POUNDS	35,584	38,197 (2)	41,011 (3)	38,880 (4)	42,177 (5)
	KILOGRAMS	16,141	17,326 (2)	18,602 (3)	17,636 (4)	19,131 (5)

- NOTES: (1) OPERATING EMPTY WEIGHT FOR BASELINE MIXED CLASS CONFIGURATION. CONSULT WITH AIRLINE FOR SPECIFIC WEIGHTS AND CONFIGURATIONS.
- (2) AIRPLANE WITH 390 GAL (1,475 L) AUXILIARY FUEL TANK IN AFT CARGO COMPARTMENT
- (3) AIRPLANE WITH 810 GAL (3,065 L) AUXILIARY FUEL TANK IN AFT CARGO COMPARTMENT
- (4) AIRPLANE WITH 500 GAL (1,893 L) AUXILIARY FUEL TANK IN AFT CARGO COMPARTMENT
- (5) AIRPLANE WITH 1,000 GAL (3,785 L) AUXILIARY FUEL TANK IN AFT CARGO COMPARTMENT

2.1.8 GENERAL CHARACTERISTICS

MODEL 737-500

D6-58325-6

20 OCTOBER 2005

CHARACTERISTICS	UNITS	MODEL 737-600		
MAX DESIGN TAXI WEIGHT	POUNDS	124,500	144,000	145,000
	KILOGRAMS	56,472	65,317	65,771
MAX DESIGN TAKEOFF WEIGHT	POUNDS	124,000	143,500	144,500
	KILOGRAMS	56,246	65,091	65,544
MAX DESIGN LANDING WEIGHT	POUNDS	120,500	120,500	121,500
	KILOGRAMS	54,658	54,658	55,112
MAX DESIGN ZERO FUEL WEIGHT	POUNDS	113,500	113,500	114,500
	KILOGRAMS	51,483	51,483	51,936
OPERATING EMPTY WEIGHT (1)	POUNDS	80,200	80,200	80,200
	KILOGRAMS	36,378	36,378	36,378
MAX STRUCTURAL PAYLOAD	POUNDS	33,300	33,300	34,300
	KILOGRAMS	15,105	15,105	15,558
SEATING CAPACITY (1)	TWO-CLASS	108	108	108
	ALL-ECONOMY	130	130	130
MAX CARGO - LOWER DECK	CUBIC FEET	756	756	756
	CUBIC METERS	21.4	21.4	21.4
USABLE FUEL	US GALLONS	6875	6875	6875
	LITERS	26,022	26,022	26,022
	POUNDS	46,063	46,063	46,063
	KILOGRAMS	20,894	20,894	20,894

NOTE: (1) OPERATING EMPTY WEIGHT FOR BASELINE MIXED CLASS CONFIGURATION.
CONSULT WITH AIRLINE FOR SPECIFIC WEIGHTS AND CONFIGURATIONS.

2.1.9 GENERAL CHARACTERISTICS

MODEL 737-600

CHARACTERISTICS	UNITS	MODEL 737-700, -700 WITH WINGLETS -700C		
MAX DESIGN TAXI WEIGHT	POUNDS	133,500	153,500	155,000
	KILOGRAMS	60,554	69,627	70,307
MAX DESIGN TAKEOFF WEIGHT	POUNDS	133,000	153,000	154,500
	KILOGRAMS	60,328	69,400	70,080
MAX DESIGN LANDING WEIGHT	POUNDS	128,000	128,000	129,200
	KILOGRAMS	58,060	58,060	58,604
MAX DESIGN ZERO FUEL WEIGHT	POUNDS	120,500	120,500	121,700
	KILOGRAMS	54,658	54,658	55,202
OPERATING EMPTY WEIGHT (1)	POUNDS	83,000	83,000	83,000
	KILOGRAMS	37,648	37,648	37,648
MAX STRUCTURAL PAYLOAD	POUNDS	37,500	37,500	38,700
	KILOGRAMS	17,010	17,010	17,554
SEATING CAPACITY (1)	TWO-CLASS	128	128	128
	ALL-ECONOMY	148	148	148
MAX CARGO - LOWER DECK	CUBIC FEET	1002	1002	1002
	CUBIC METERS	28.4	28.4	28.4
USABLE FUEL	US GALLONS	6875	6875	6875
	LITERS	26,022	26,022	26,022
	POUNDS	46,063	46,063	46,063
	KILOGRAMS	20,894	20,894	20,894

NOTE: (1) OPERATING EMPTY WEIGHT FOR BASELINE MIXED CLASS CONFIGURATION.
CONSULT WITH AIRLINE FOR SPECIFIC WEIGHTS AND CONFIGURATIONS.

2.1.10 GENERAL CHARACTERISTICS
MODEL 737-700, -700 WITH WINGLETS, -700C

D6-58325-6

22 OCTOBER 2005

CHARACTERISTICS	UNITS	MODEL 737-800, -800 WITH WINGLETS		
MAX DESIGN TAXI WEIGHT	POUNDS	156,000	173,000	174,700
	KILOGRAMS	70,760	78,472	79,243
MAX DESIGN TAKEOFF WEIGHT	POUNDS	155,500	172,500	174,200
	KILOGRAMS	70,534	78,245	79,016
MAX DESIGN LANDING WEIGHT	POUNDS	144,000	144,000	146,300
	KILOGRAMS	65,317	65,317	66,361
MAX DESIGN ZERO FUEL WEIGHT	POUNDS	136,000	136,000	138,300
	KILOGRAMS	61,689	61,689	62,732
OPERATING EMPTY WEIGHT (1)	POUNDS	91,300	91,300	91,300
	KILOGRAMS	41,413	41,413	41,413
MAX STRUCTURAL PAYLOAD	POUNDS	44,700	44,700	47,000
	KILOGRAMS	20,276	20,276	21,319
SEATING CAPACITY (1)	TWO-CLASS	160	160	160
	ALL-ECONOMY	184	184	184
MAX CARGO - LOWER DECK	CUBIC FEET	1591	1591	1591
	CUBIC METERS	45.1	45.1	45.1
USABLE FUEL	US GALLONS	6875	6875	6875
	LITERS	26,022	26,022	26,022
	POUNDS	46,063	46,063	46,063
	KILOGRAMS	20,894	20,894	20,894

NOTE: (1) OPERATING EMPTY WEIGHT FOR BASELINE MIXED CLASS CONFIGURATION.
CONSULT WITH AIRLINE FOR SPECIFIC WEIGHTS AND CONFIGURATIONS.

2.1.11 GENERAL CHARACTERISTICS
MODEL 737-800, -800 WITH WINGLETS

CHARACTERISTICS	UNITS	MODEL 737-900, -900 WITH WINGLETS	
MAX DESIGN TAXI WEIGHT	POUNDS	164,500	174,700
	KILOGRAMS	74,616	79,243
MAX DESIGN TAKEOFF WEIGHT	POUNDS	164,000	174,200
	KILOGRAMS	74,389	79,016
MAX DESIGN LANDING WEIGHT	POUNDS	146,300	146,300
	KILOGRAMS	66,361	66,361
MAX DESIGN ZERO FUEL WEIGHT	POUNDS	138,300	140,300
	KILOGRAMS	62,732	63,639
OPERATING EMPTY WEIGHT (1)	POUNDS	94,580	94,580
	KILOGRAMS	42,901	42,901
MAX STRUCTURAL PAYLOAD	POUNDS	43,720	45,720
	KILOGRAMS	19,831	20,738
SEATING CAPACITY (1)	TWO-CLASS	177	177
	ALL-ECONOMY	189	189
MAX CARGO - LOWER DECK	CUBIC FEET	1,835	1,835
	CUBIC METERS	52.0	52.0
USABLE FUEL	US GALLONS	6875	6875
	LITERS	26,022	26,022
	POUNDS	46,063	46,063
	KILOGRAMS	20,894	20,894

NOTE: (1) OPERATING EMPTY WEIGHT FOR BASELINE MIXED CLASS CONFIGURATION.
CONSULT WITH AIRLINE FOR SPECIFIC WEIGHTS AND CONFIGURATIONS.

2.1.12 GENERAL CHARACTERISTICS
MODEL 737-900, -900 WITH WINGLETS

PRELIMINARY INFORMATION

CHARACTERISTICS	UNITS	MODEL 737-900ER, -900ER WITH WINGLETS		
MAX DESIGN TAXI WEIGHT	POUNDS	164,500	188,200	
	KILOGRAMS	74,616	85,366	
MAX DESIGN TAKEOFF WEIGHT	POUNDS	164,000	187,700	
	KILOGRAMS	74,389	85,139	
MAX DESIGN LANDING WEIGHT	POUNDS	146,300	157,300	
	KILOGRAMS	66,361	71,350	
MAX DESIGN ZERO FUEL WEIGHT	POUNDS	138,300	149,300	
	KILOGRAMS	62,732	67,721	
OPERATING EMPTY WEIGHT (1)	POUNDS	98,495	98,495	
	KILOGRAMS	44,676	44,676	
MAX STRUCTURAL PAYLOAD	POUNDS	39,308	50,805	
	KILOGRAMS	17,830	23,045	
SEATING CAPACITY (1)	TWO-CLASS	177	177	
	ALL-ECONOMY	186 WITH MID EXIT DOOR, 215: FAA EXIT LIMIT		
AUXILIARY FUEL OPTIONS	SEE NOTES	(2)	(3)	(4)
MAX CARGO - LOWER DECK	CUBIC FEET	1,826	1,763	1,585
	CUBIC METERS	51.7	40.9	44.9
USABLE FUEL	US GALLONS	6,875	7,395	7,387
	LITERS	26,022	27,990	29,663
	POUNDS	46,063	49,547	52,508
	KILOGRAMS	20,894	22,474	23,817

NOTES:

- (1) OPERATING EMPTY WEIGHT FOR BASELINE MIXED CLASS CONFIGURATION. CONSULT WITH AIRLINE FOR SPECIFIC WEIGHTS AND CONFIGURATIONS.
- (2) WITH NO AUXILIARY FUEL TANK
- (3) WITH ONE AUXILIARY FUEL TANK
- (4) WITH TWO AUXILIARY FUEL TANKS

2.1.13 GENERAL CHARACTERISTICS

MODEL 737-900ER, -900ER WITH WINGLETS

CHARACTERISTICS	UNITS	MODEL 737 BBJ
MAX DESIGN	POUNDS	171,500
TAXI WEIGHT	KILOGRAMS	77,791
MAX DESIGN	POUNDS	171,000
TAKEOFF WEIGHT	KILOGRAMS	77,564
MAX DESIGN	POUNDS	134,000
LANDING WEIGHT	KILOGRAMS	60,781
MAX DESIGN	POUNDS	126,000
ZERO FUEL WEIGHT	KILOGRAMS	57,152

NUMBER OF AUXILIARY FUEL TANKS		3	4	5	6	7	8	9
SPEC OPERATING	POUNDS	92,345	92,722	93,393	93,785	94,056	94,352	94,570
EMPTY WEIGHT (1)	KILOGRAMS	41,887	42,058	42,362	43,540	42,663	42,797	42,896
MAX STRUCTURAL	POUNDS	33,655	33,278	32,607	32,215	31,944	31,648	31,430
PAYLOAD	KILOGRAMS	15,300	15,126	14,821	14,609	14,520	14,385	14,286
MAX CARGO	CUBIC FEET	611	515	415	319	268	214	160
- LOWER DECK	CUBIC METERS	17.3	14.6	11.7	9.0	7.6	6.1	4.6
USABLE FUEL	US GALLONS	8,360	8,897	9,399	9,917	10,213	10,457	10,697
	LITERS	31,646	33,611	35,579	37,540	38,660	39,584	40,485
	POUNDS	56,012	59,610	62,973	66,444	68,427	70,062	71,670
	KILOGRAMS	25,460	27,095	28,624	30,202	31,103	31,846	32,577

NOTES:

- (1) SPEC WEIGHT FOR NUMBER OF AUXILIARY FUEL TANKS SHOWN. CONSULT WITH AIRCRAFT OPERATOR FOR SPECIFIC WEIGHTS AND CONFIGURATIONS.

2.1.14 GENERAL CHARACTERISTICS

MODEL 737 BBJ

D6-58325-6

26 OCTOBER 2005

CHARACTERISTICS	UNITS	MODEL 737 BBJ2
MAX DESIGN	POUNDS	174,700
TAXI WEIGHT	KILOGRAMS	79,245
MAX DESIGN	POUNDS	174,200
TAKEOFF WEIGHT	KILOGRAMS	79,015
MAX DESIGN	POUNDS	146,300
LANDING WEIGHT	KILOGRAMS	66,360
MAX DESIGN	POUNDS	138,300
ZERO FUEL WEIGHT	KILOGRAMS	62,732

NUMBER OF AUXILIARY FUEL TANKS		0	1	2	3	4	5	6	7
SPEC OPERATING	POUNDS	96,727	97,372	97,821	98,344	98,722	99,393	99,785	100,312
EMPTY WEIGHT (1)	KILOGRAMS	43,875	44,167	44,371	44,608	44,780	45,084	45,262	45,501
MAX STRUCTURAL	POUNDS	41,573	40,928	40,479	39,356	39,578	38,907	38,515	37,988
PAYLOAD	KILOGRAMS	18,859	18,570	18,366	18,130	17,960	17,563	17,475	17,236
MAX CARGO	CUBIC FEET	1,546	1,423	1,331	1,224	1,116	1,029	922	814
- LOWER DECK	CUBIC METERS	43.8	40.3	37.7	34.7	31.6	29.2	26.1	23.1
USABLE FUEL	US GALLONS	6,875	7,395	7,837	8,360	8,879	9,399	9,917	10,443
	LITERS	26,025	27,992	29,665	31,645	33,609	35,578	37,538	39,530
	POUNDS	46,080	49,546	52,508	56,012	59,489	62,973	66,571	69,968
	KILOGRAMS	20,910	22,480	23,824	25,414	26,992	28,572	30,214	31,746

NOTES:

- (1) SPEC WEIGHT FOR NUMBER OF AUXILIARY FUEL TANKS SHOWN. CONSULT WITH AIRCRAFT OPERATOR FOR SPECIFIC WEIGHTS AND CONFIGURATIONS.

2.1.15 GENERAL CHARACTERISTICS

MODEL 737 BBJ2

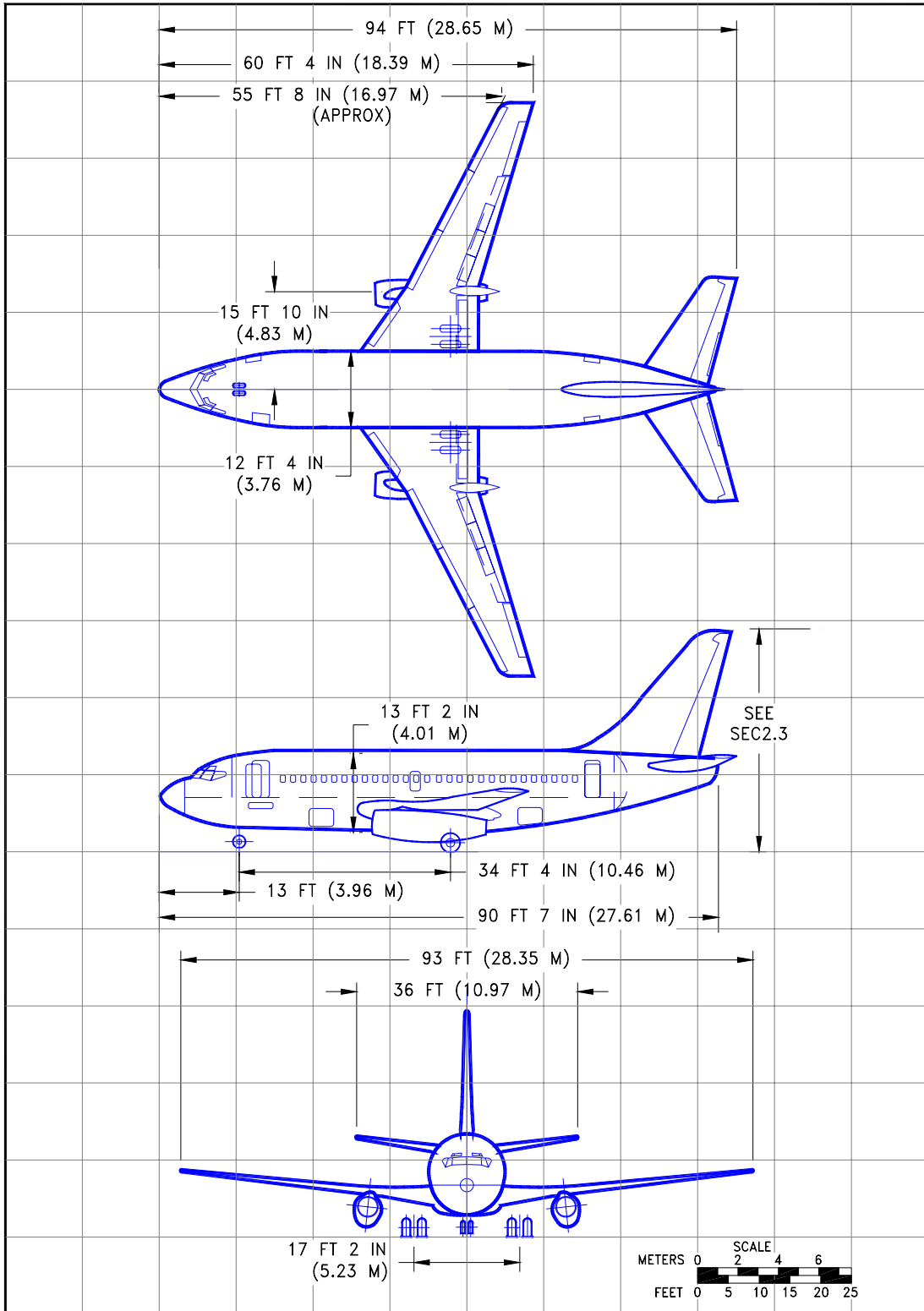

2.2.1 GENERAL DIMENSIONS

MODEL 737-100

D6-58325-6

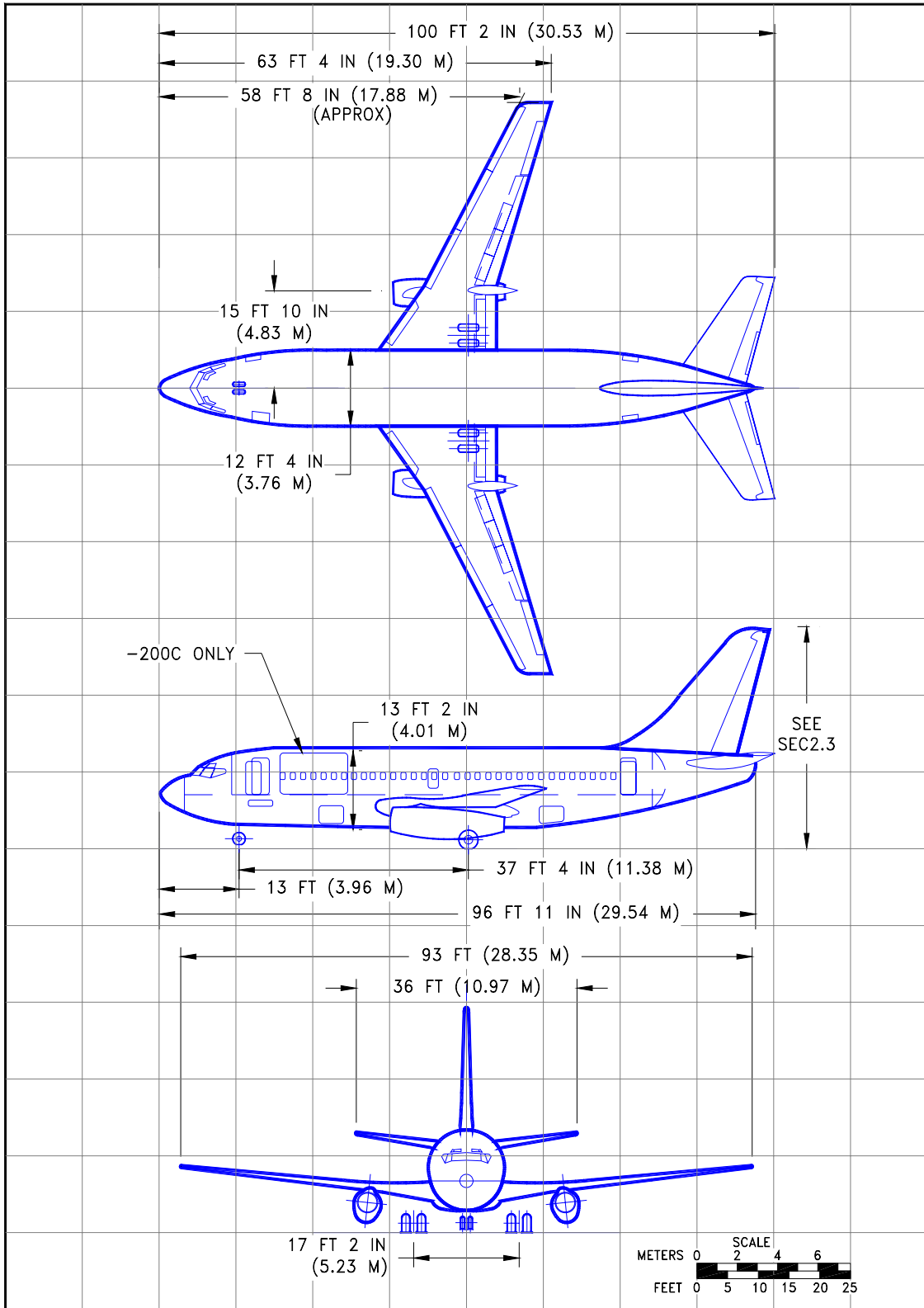

2.2.2 GENERAL DIMENSIONS
MODEL 737-200

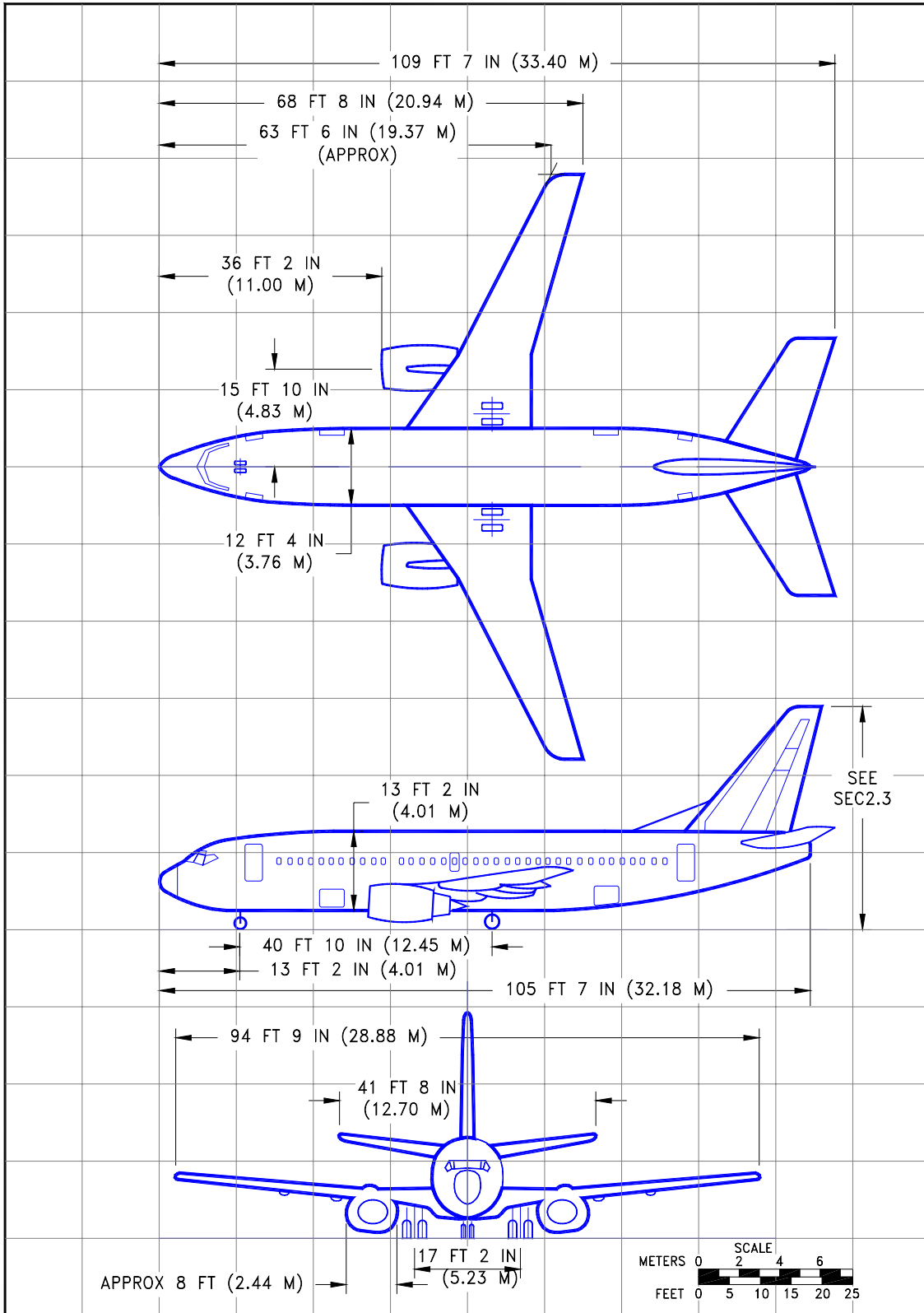

2.2.3 GENERAL DIMENSIONS
 MODEL 737-300

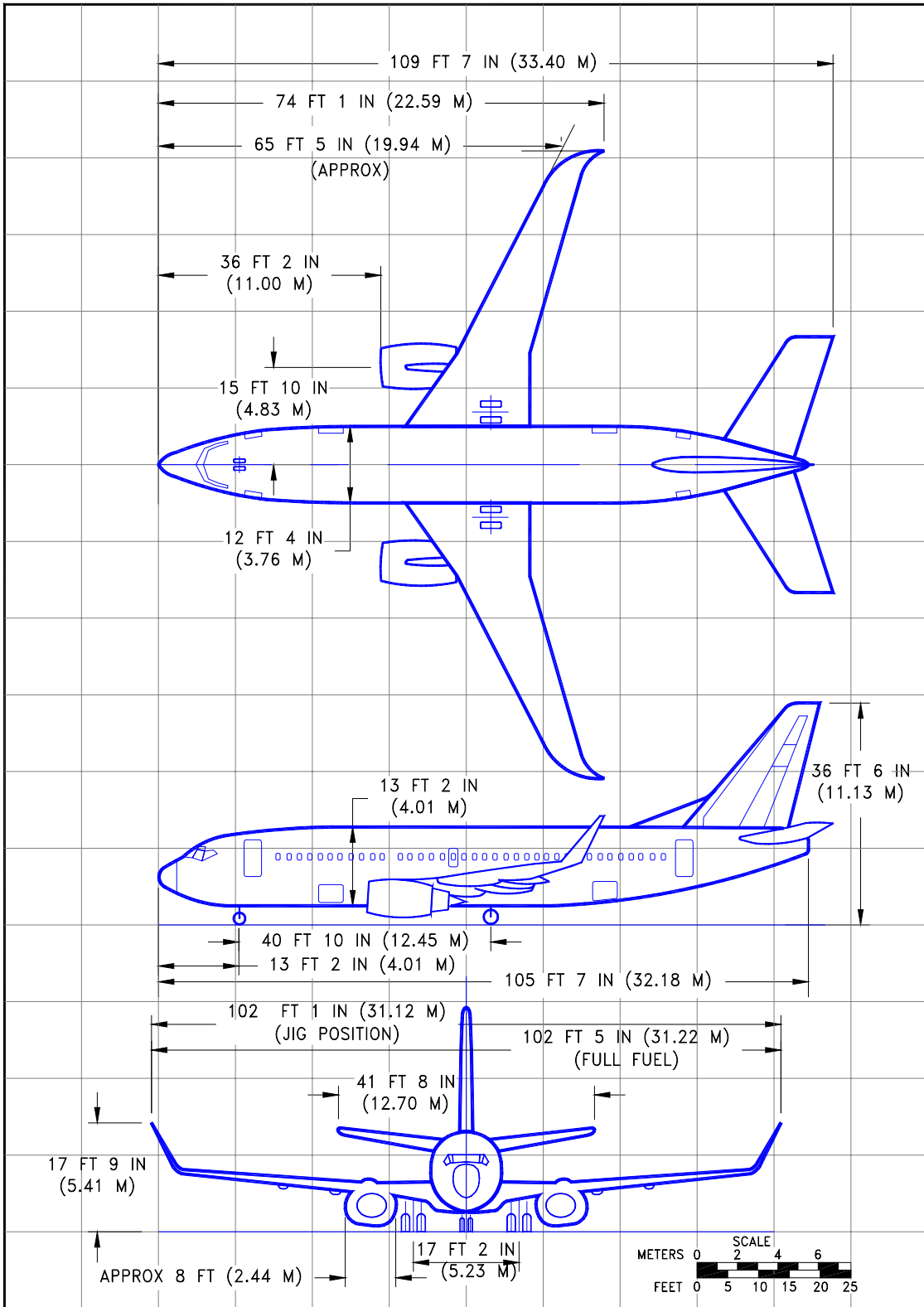

2.2.4 GENERAL DIMENSIONS
MODEL 737-300 WITH WINGLETS

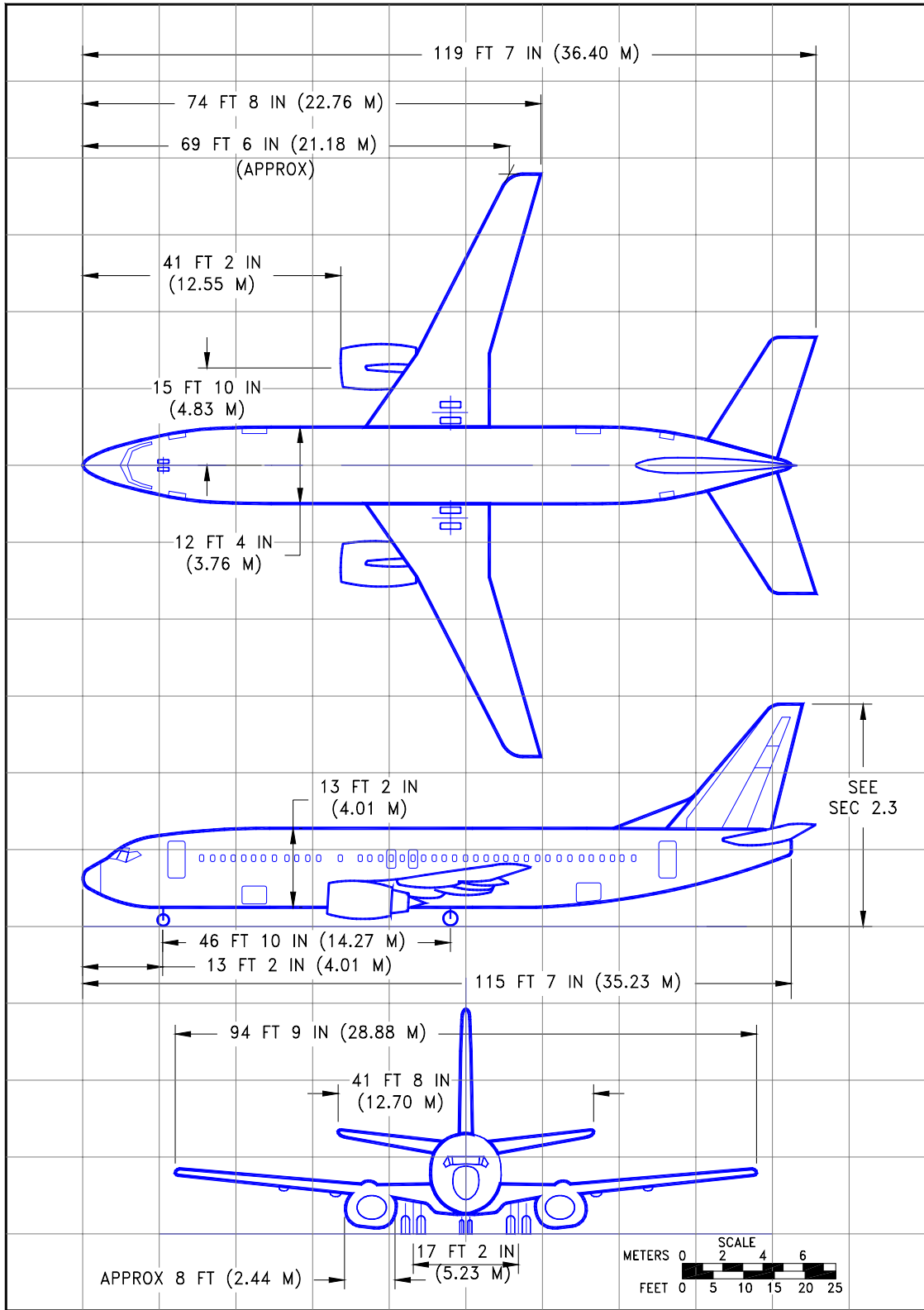

2.2.5 GENERAL DIMENSIONS

MODEL 737-400

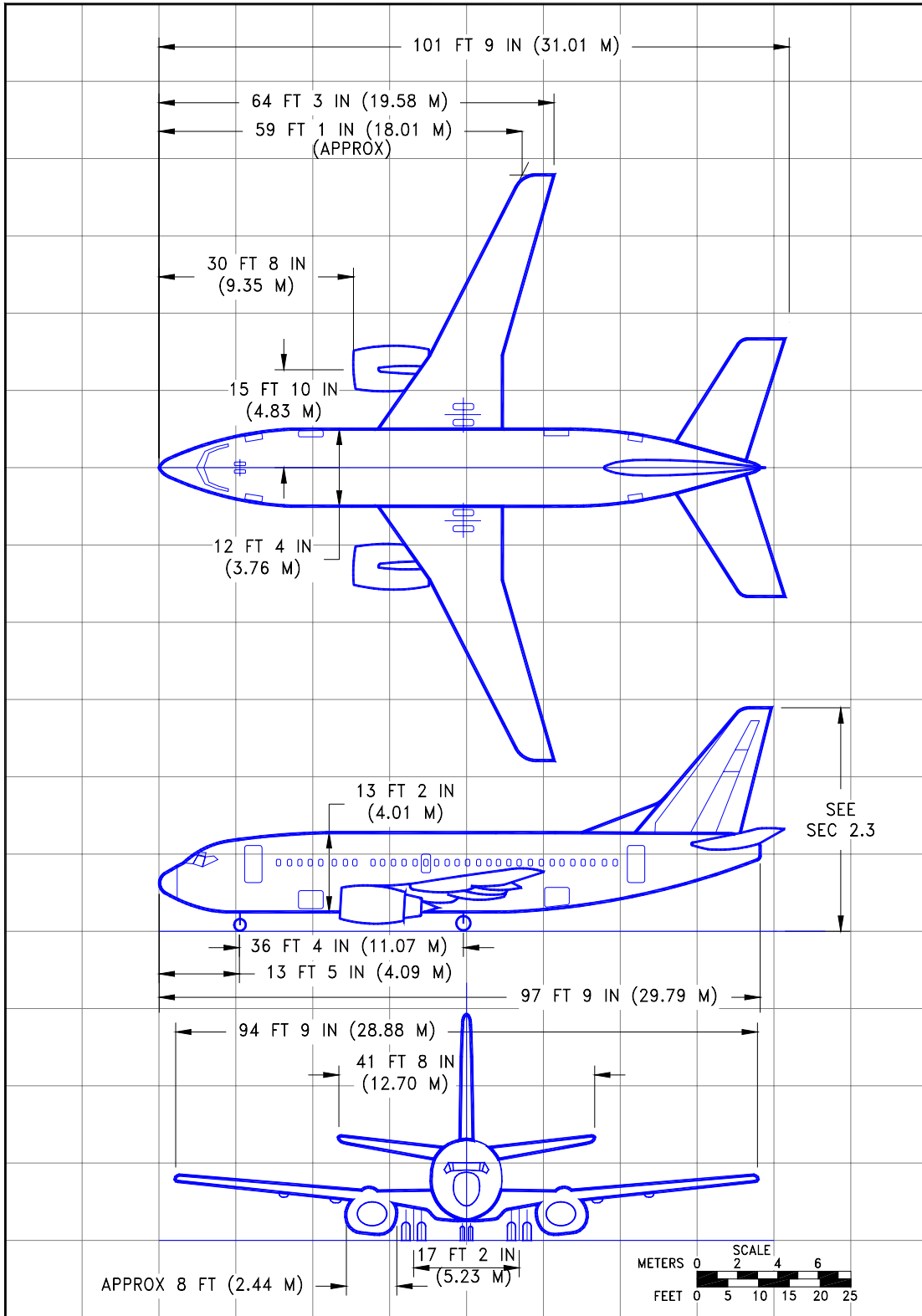

2.2.6 GENERAL DIMENSIONS
MODEL 737-500

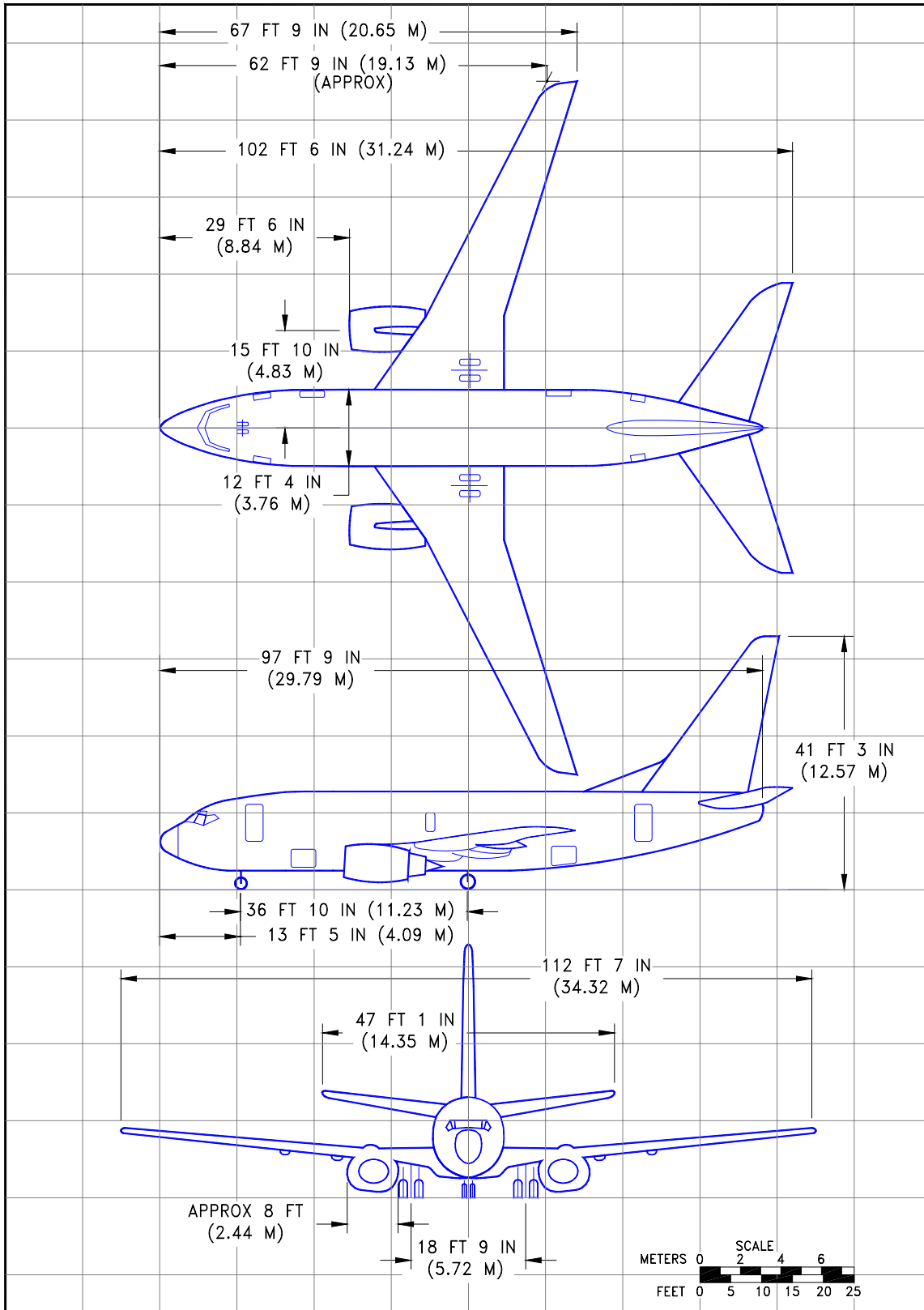

2.2.7 GENERAL DIMENSIONS
MODEL 737-600

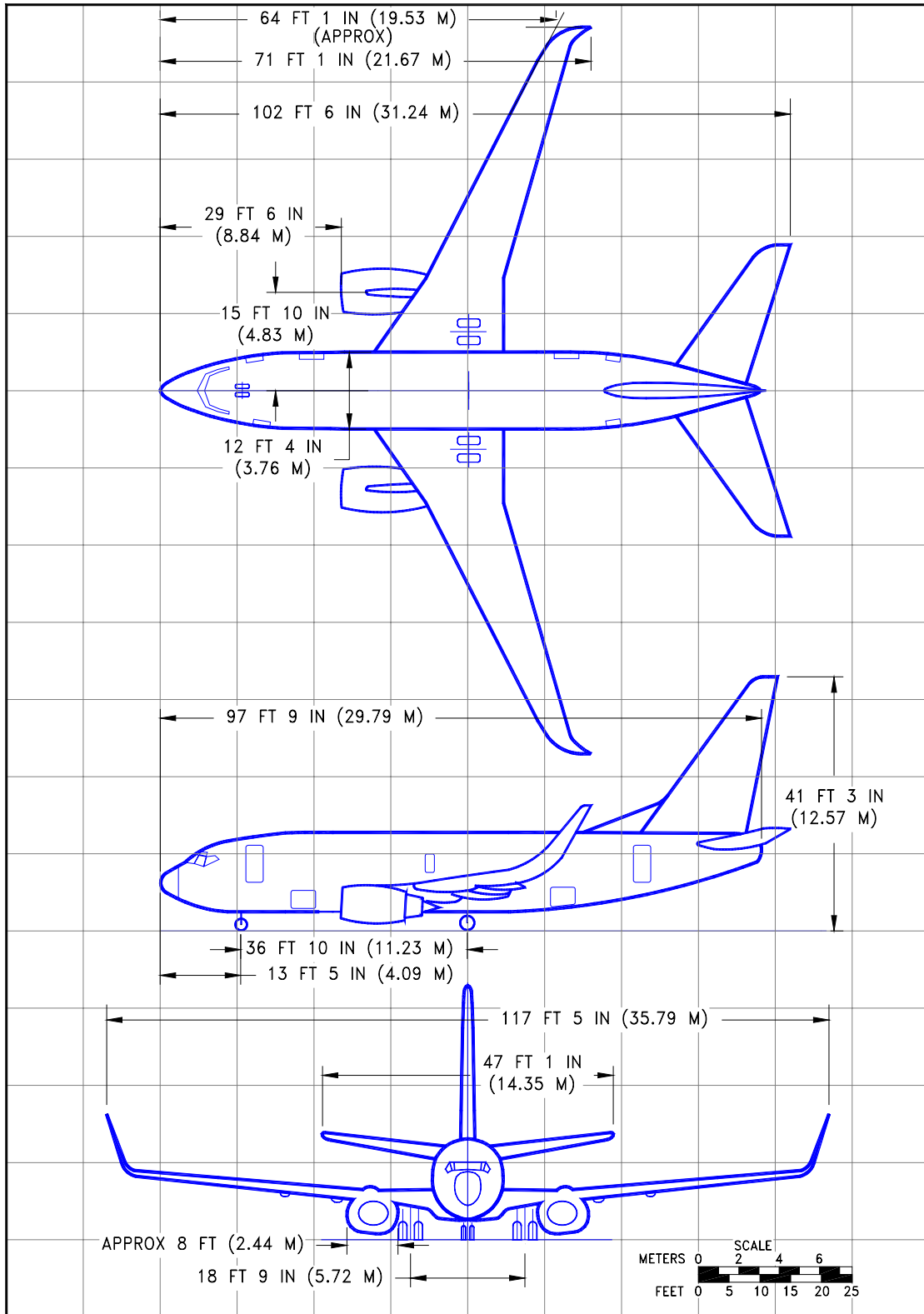

2.2.8 GENERAL DIMENSIONS
MODEL 737-600 WITH WINGLETS

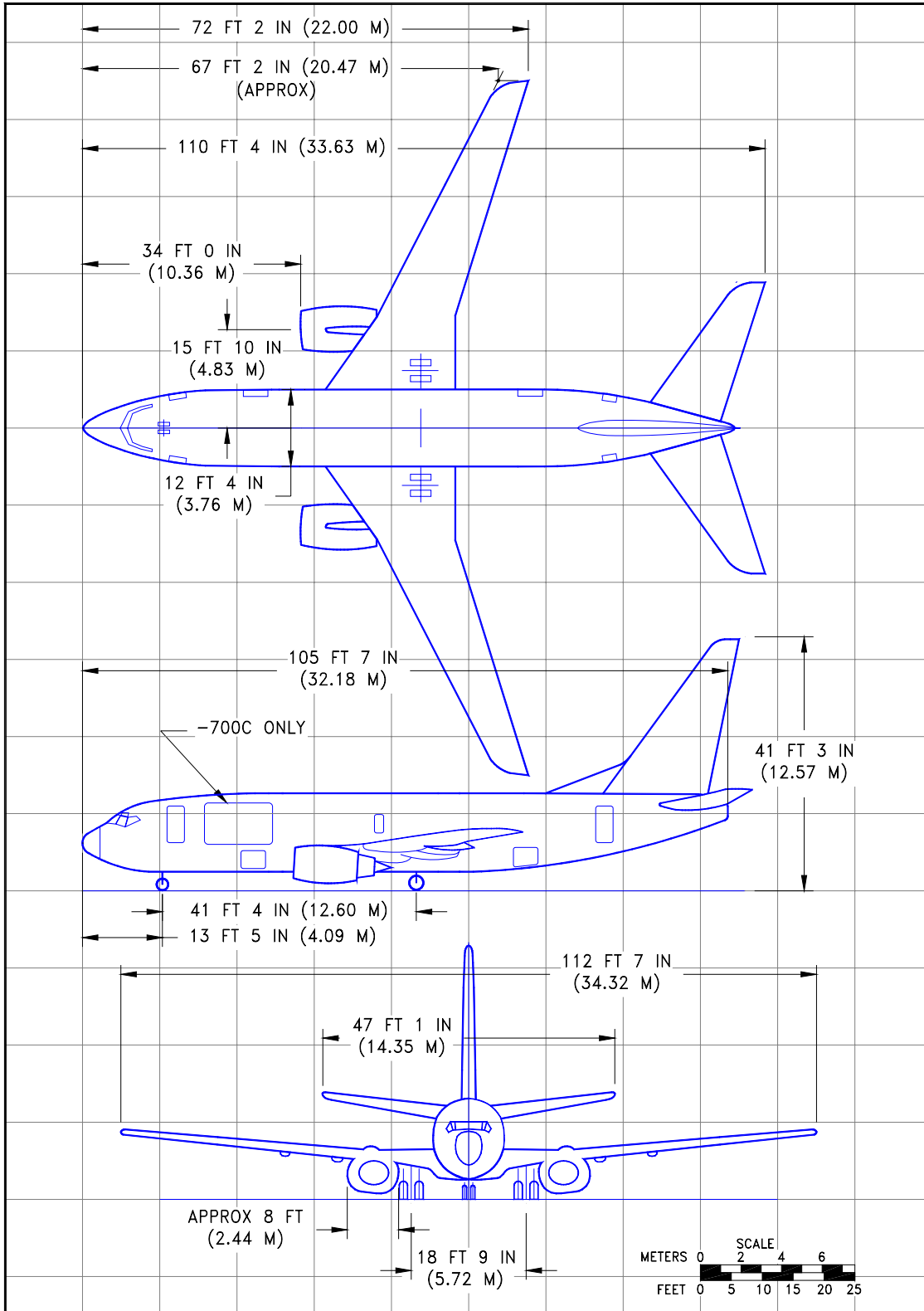

2.2.9 GENERAL DIMENSIONS
MODEL 737-700, -700C

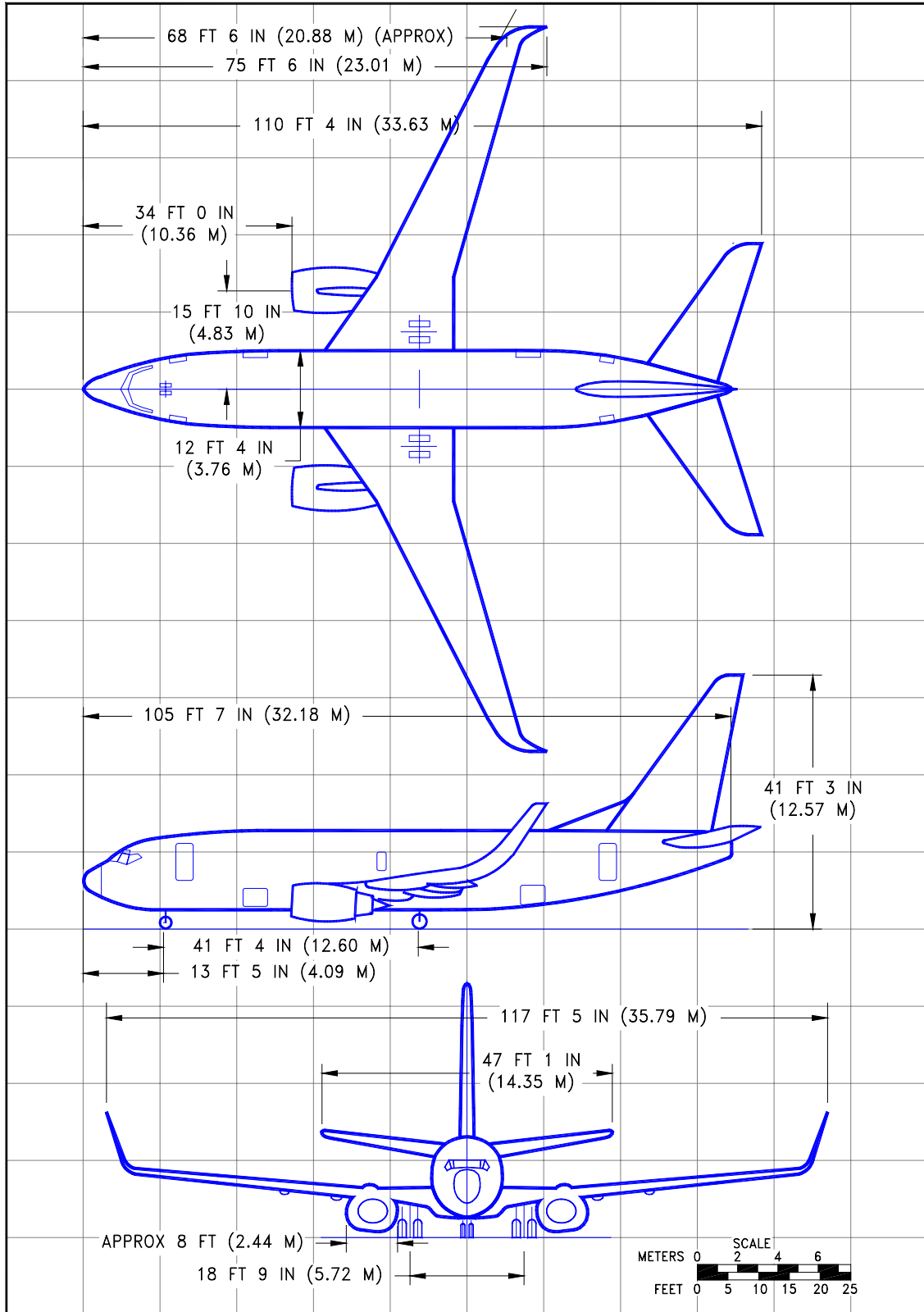

2.2.10 GENERAL DIMENSIONS
 MODEL 737-700 WITH WINGLETS, 737 BBJ

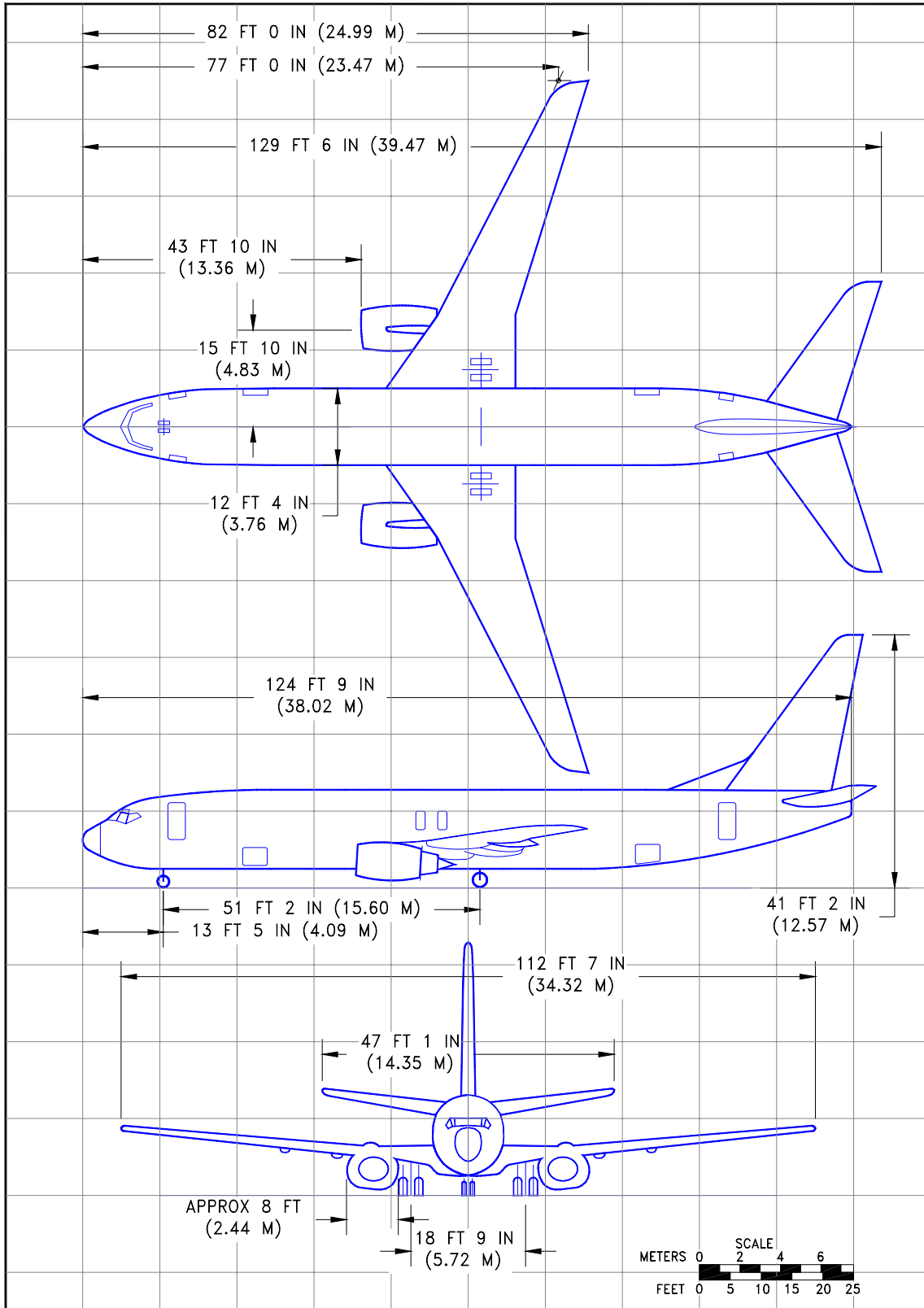

2.2.11 GENERAL DIMENSIONS
MODEL 737-800

D6-58325-6

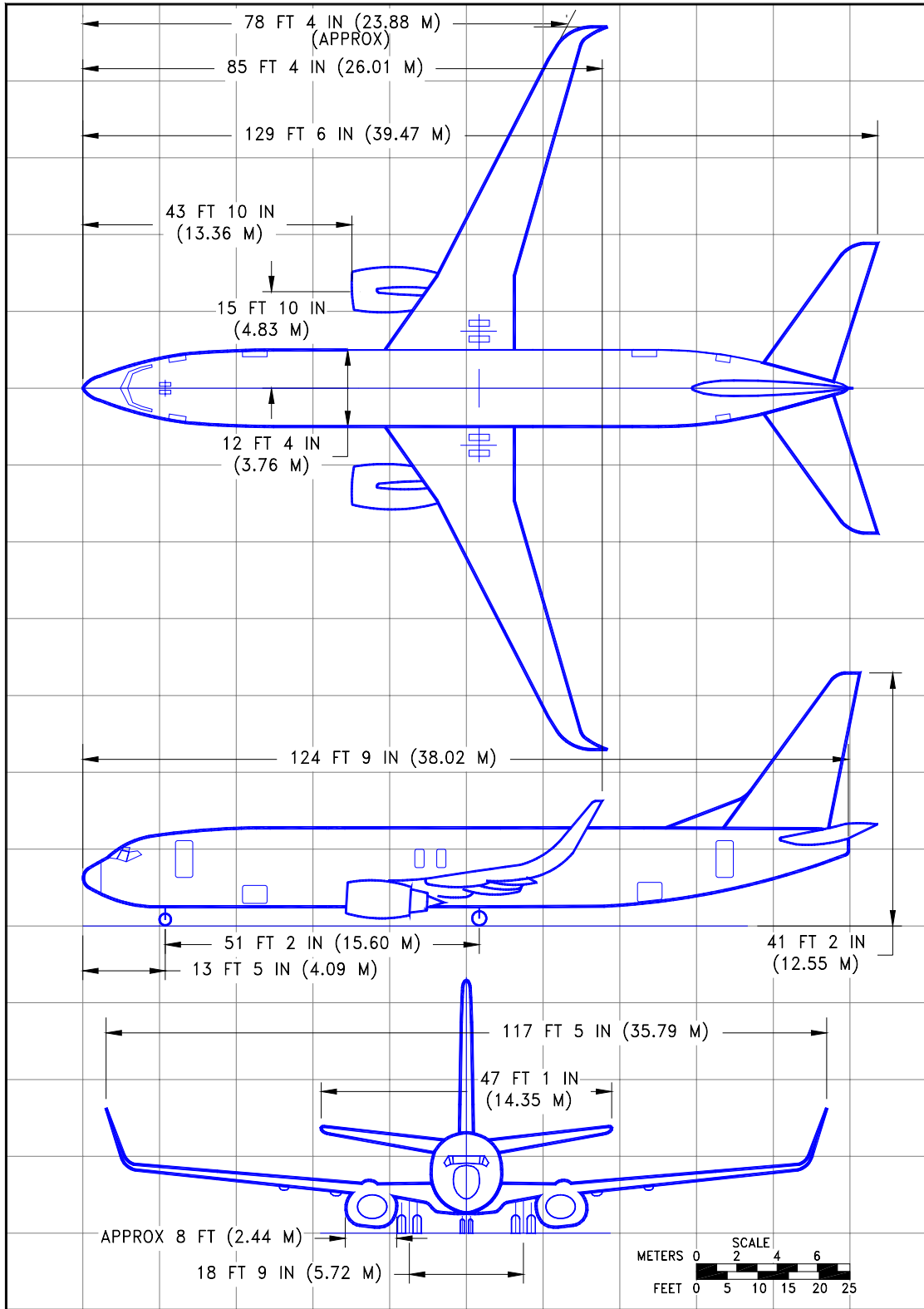

2.2.12 GENERAL DIMENSIONS
MODEL 737-800 WITH WINGLETS, 737 BBJ2

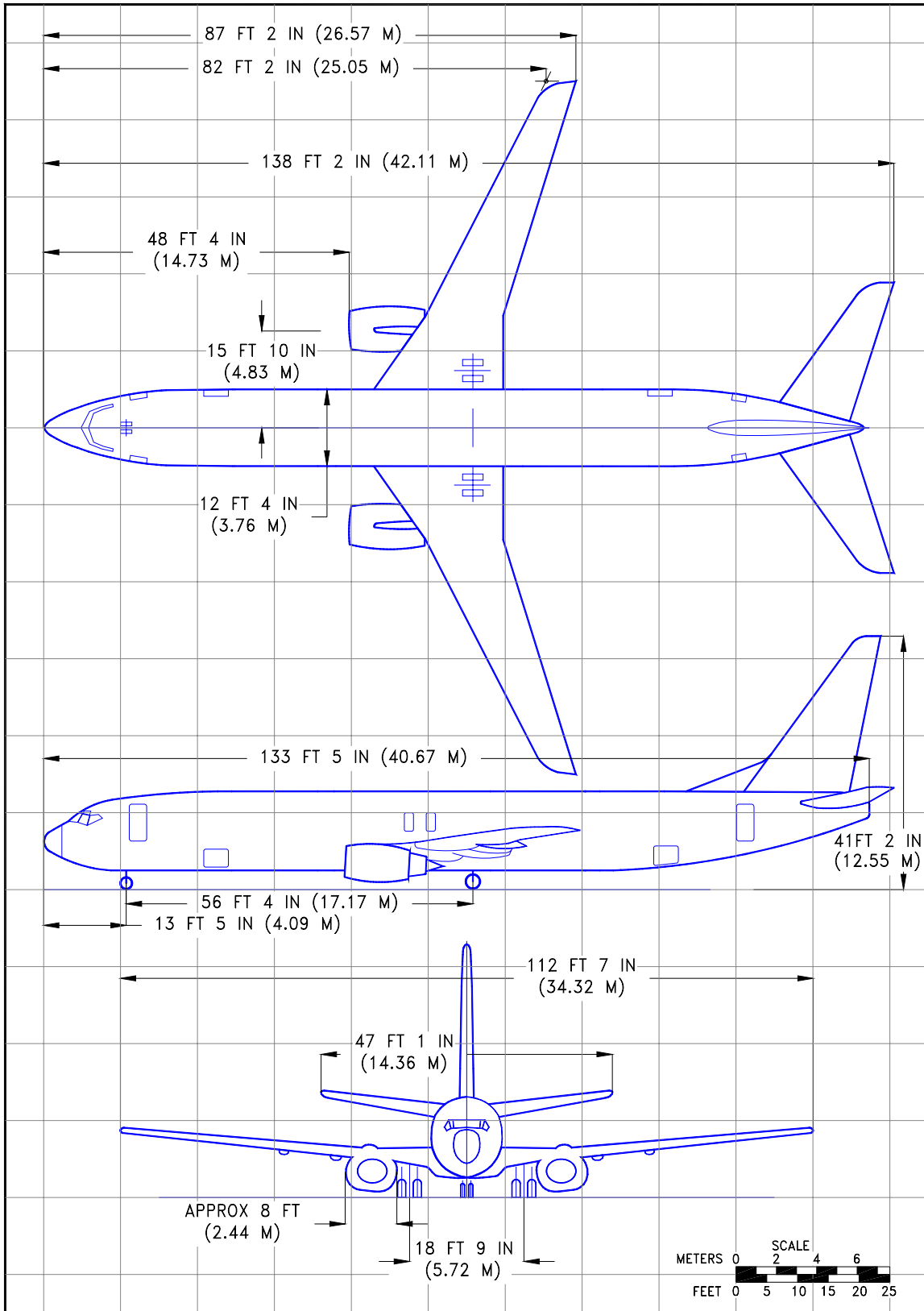

2.2.13 GENERAL DIMENSIONS

MODEL 737-900, -900ER

D6-58325-6

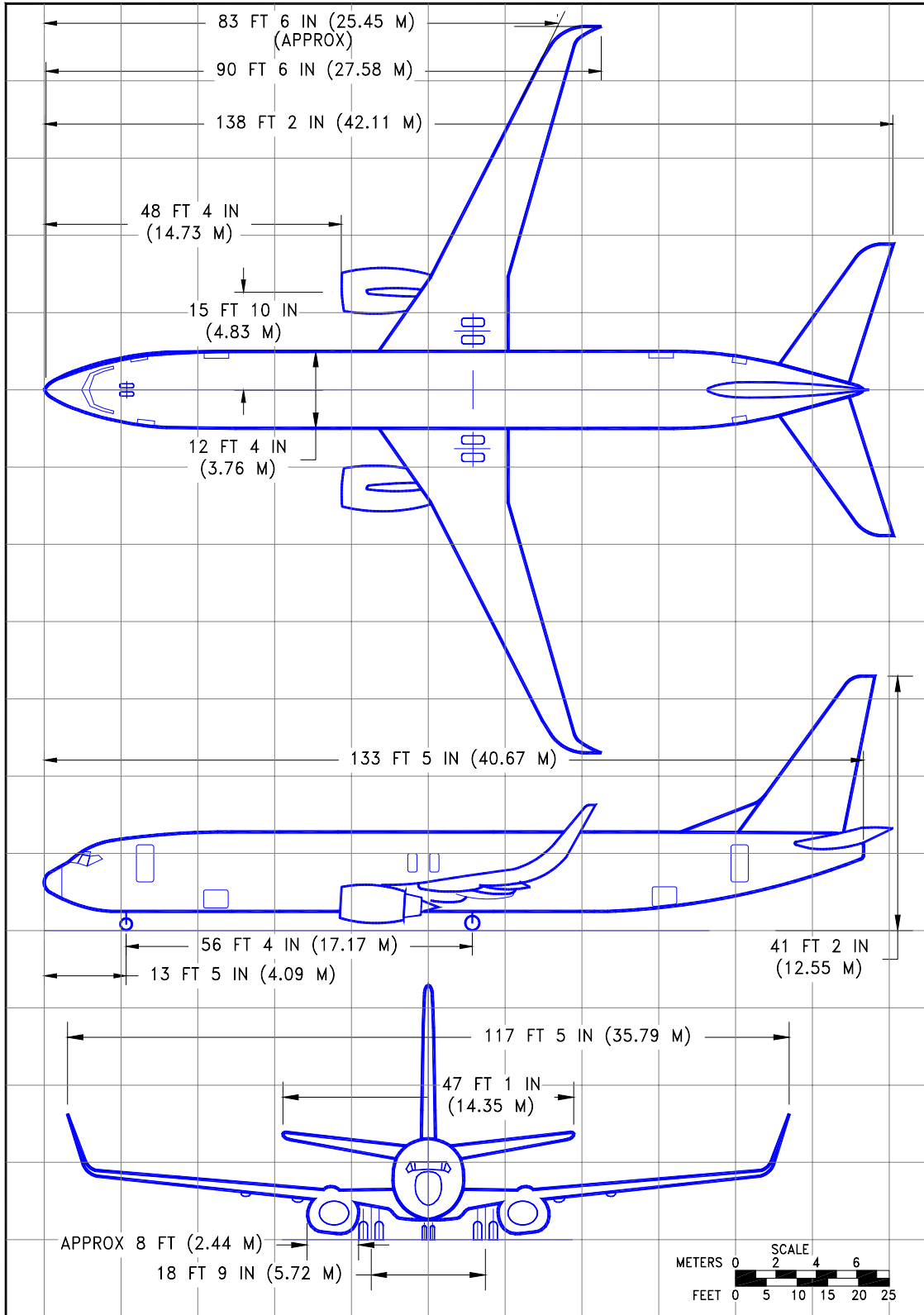

2.2.14 GENERAL DIMENSIONS
 MODEL 737-900, -900ER WITH WINGLETS

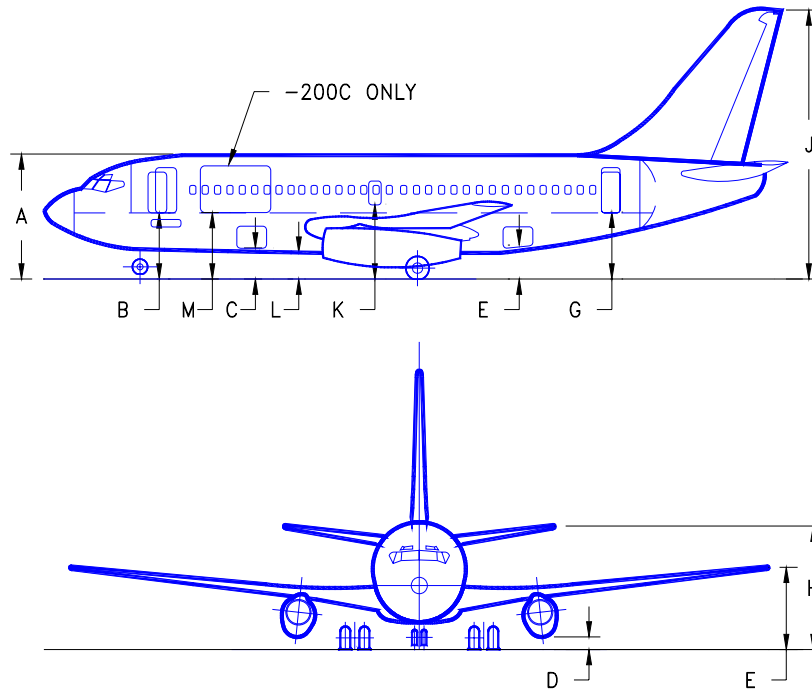

DESCRIPTION	737-100				737-200, -200C				
	MAX (AT OEW)		MIN (AT MTW)		MAX (AT OEW)		MIN (AT MTW)		
	FT - IN	M	FT - IN	M	FT - IN	M	FT - IN	M	
A	TOP OF FUSELAGE	16 - 9	5.11	16 - 5	5.00	16 - 9	5.11	16 - 4	4.98
B	ENTRY DOOR NO 1	8 - 8	2.64	8 - 1	2.46	8 - 7	2.62	8 - 1	2.46
C	FWD CARGO DOOR	4 - 3	1.30	3 - 10	1.17	4 - 3	1.30	3 - 10	1.17
D	ENGINE	1 - 11	0.58	1 - 8	0.51	1 - 11	0.58	1 - 8	0.51
E	WINGTIP	10 - 2	3.09	10 - 0	3.05	10 - 2	3.09	10 - 0	3.05
F	AFT CARGO DOOR	5 - 1	1.55	5 - 0	1.52	4 - 9	1.45	4 - 9	1.45
G	ENTRY DOOR NO 2	9 - 0	2.74	9 - 1	2.77	9 - 0	2.74	9 - 2	2.79
H	STABILIZER	16 - 8	5.08	17 - 0	5.18	16 - 8	5.08	17 - 1	5.21
J	VERTICAL TAIL	36 - 10	11.23	37 - 2	11.33	36 - 10	11.23	37 - 3	11.35
K	OVERWING EXIT DOOR	10 - 5	3.18	10 - 3	3.12	10 - 5	3.18	10 - 3	3.12
L	BOTTOM OF FUSELAGE	3 - 7	1.09	3 - 1	0.94	3 - 6	1.07	3 - 0	0.91
M	MAIN DECK CARGO DOOR	-	-	-	-	8 - 7	2.62	8 - 1	2.46

NOTES: CLEARANCES SHOWN ARE NOMINAL. ADD PLUS OR MINUS 3 INCHES TO ACCOUNT FOR VARIATIONS IN LOADING, OLEO AND TIRE PRESSURES, CENTER OF GRAVITY, ETC.

DURING ROUTINE SERVICING, THE AIRPLANE REMAINS RELATIVELY STABLE, PITCH AND ELEVATION CHANGES OCCURRING SLOWLY.

2.3.1 GROUND CLEARANCES

MODEL 737-100, -200, -200C

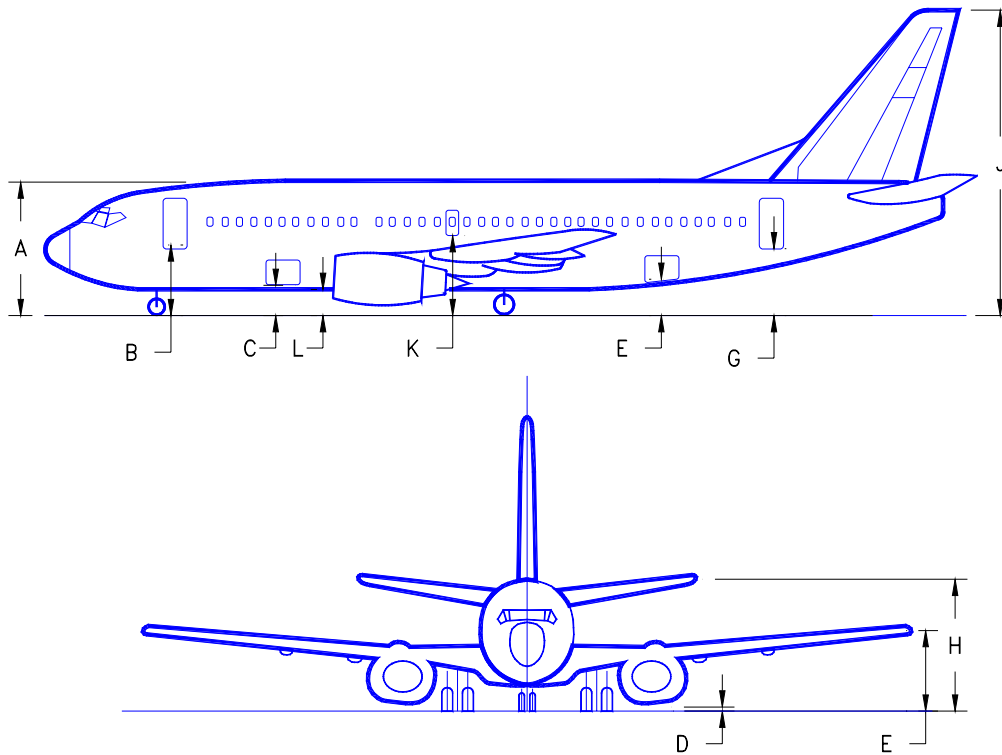

DESCRIPTION	737-300, -400, -500				
	MAX (AT OEW)		MIN (AT MTW)		
	FT - IN	M	FT - IN	M	
A	TOP OF FUSELAGE	17 - 3	5.26	16 - 10	5.13
B	ENTRY DOOR NO 1	9 - 1	2.77	8 - 7	2.62
C	FWD CARGO DOOR	4 - 7	1.40	4 - 2	1.27
D	ENGINE	1 - 9	0.53	1 - 6	0.46
E	WINGTIP	10 - 2	3.09	10 - 0	3.05
F	AFT CARGO DOOR	4 - 6	1.37	4 - 6	1.37
G	ENTRY DOOR NO 2	8 - 7	2.62	8 - 9	2.67
H	STABILIZER	16 - 3	4.95	16 - 8	5.08
J	VERTICAL TAIL	36 - 4	11.07	36 - 7	11.15
K	OVERWING EXIT DOOR	10 - 6	3.20	10 - 4	3.15
L	BOTTOM OF FUSELAGE	3 - 10	1.17	3 - 4	1.02

NOTES: CLEARANCES SHOWN ARE NOMINAL. ADD PLUS OR MINUS 3 INCHES TO ACCOUNT FOR VARIATIONS IN LOADING, OLEO AND TIRE PRESSURES, CENTER OF GRAVITY, ETC.

DURING ROUTINE SERVICING, THE AIRPLANE REMAINS RELATIVELY STABLE, PITCH AND ELEVATION CHANGES OCCURRING SLOWLY.

2.3.2 GROUND CLEARANCES
MODEL 737-300, -400, -500

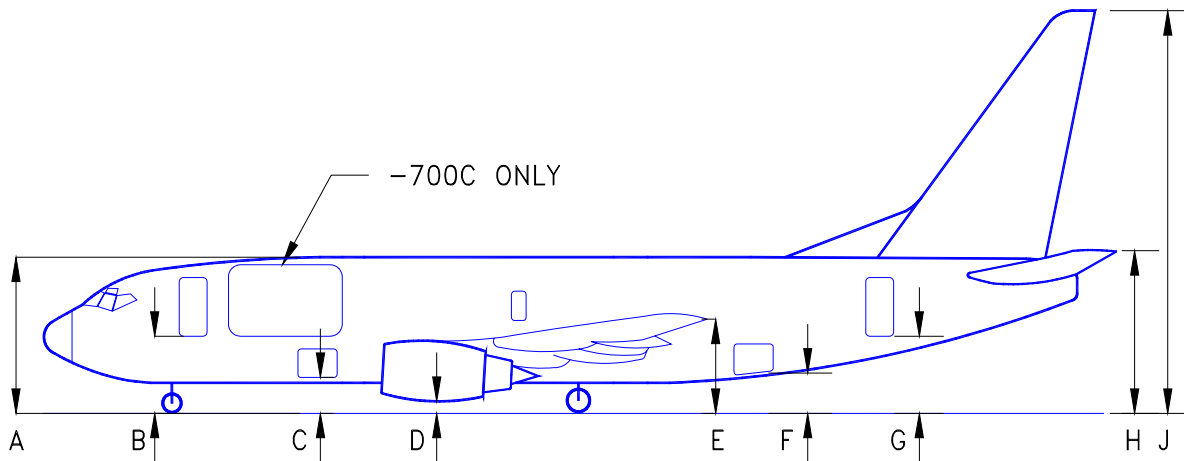

DESCRIPTION	737-600				737-700, -700C				
	MAX (AT OEW)		MIN (AT MTW)		MAX (AT OEW)		MIN (AT MTW)		
	FT - IN	M	FT - IN	M	FT IN	M	FT IN	M	
A	TOP OF FUSELAGE	18 - 2	5.54	17 - 8	5.38	18 - 3	5.56	17 - 9	5.41
B	ENTRY DOOR NO 1	9 - 0	2.74	8 - 6	2.59	9 - 0	2.74	8 - 6	2.59
C	FWD CARGO DOOR	4 - 9	1.45	4 - 3	1.30	4 - 9	1.45	4 - 3	1.30
D	ENGINE	2 - 0	0.61	1 - 6	0.46	2 - 0	0.61	1 - 6	0.46
E	WINGTIP	12 - 9	3.89	11 - 11	3.63	12 - 9	3.89	11 - 11	3.63
F	AFT CARGO DOOR	5 - 10	1.78	5 - 4	1.63	5 - 10	1.78	5 - 4	1.63
G	ENTRY DOOR NO 2	10 - 2	3.10	9 - 8	2.95	10 - 2	3.10	9 - 8	2.95
H	STABILIZER	18 - 5	5.61	17 - 11	5.46	18 - 5	5.61	17 - 11	5.46
J	VERTICAL TAIL	41 - 8	12.70	40 - 10	12.45	41 - 7	12.67	40 - 10	12.45

NOTES: CLEARANCES SHOWN ARE NOMINAL. ADD PLUS OR MINUS 3 INCHES TO ACCOUNT FOR VARIATIONS IN LOADING, OLEO AND TIRE PRESSURES, CENTER OF GRAVITY, ETC.

DURING ROUTINE SERVICING, THE AIRPLANE REMAINS RELATIVELY STABLE, PITCH AND ELEVATION CHANGES OCCURRING SLOWLY.

2.3.3 GROUND CLEARANCES

MODEL 737-600, -700, -700C

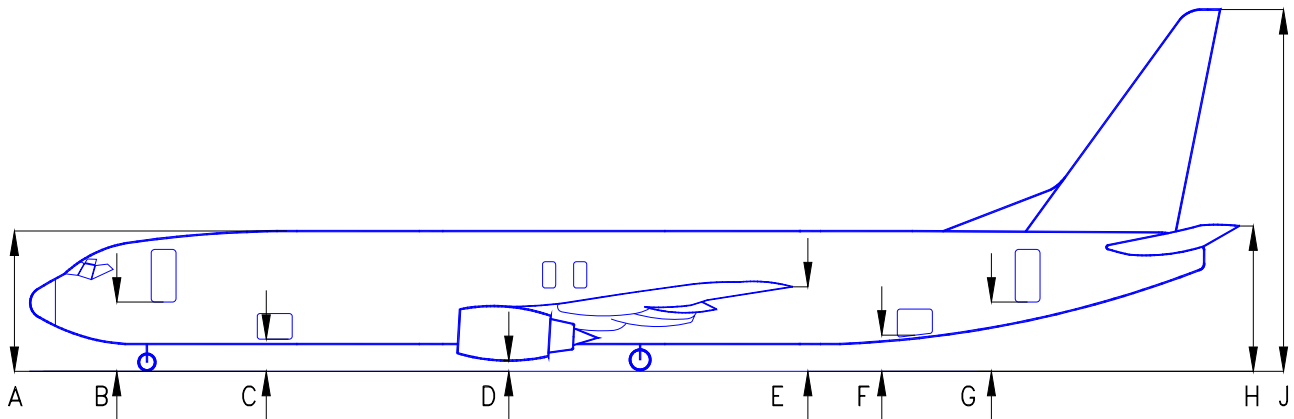

DESCRIPTION	737-800				737-900				
	MAX (AT OEW)		MIN (AT MTW)		MAX (AT OEW)		MIN (AT MTW)		
	FT - IN	M	FT - IN	M	FT IN	M	FT IN	M	
A	TOP OF FUSELAGE	18 - 3	5.56	17 - 9	5.41	18 - 4	5.59	17 - 10	5.44
B	ENTRY DOOR NO 1	9 - 0	2.74	8 - 6	2.59	9 - 0	2.74	8 - 6	2.59
C	FWD CARGO DOOR	4 - 9	1.45	4 - 3	1.30	4 - 9	1.45	4 - 3	1.30
D	ENGINE	2 - 1	0.64	1 - 7	0.48	2 - 1	0.64	1 - 7	0.48
E	WINGTIP	12 - 10	3.91	12 - 0	3.66	12 - 10	3.91	12 - 0	3.66
F	AFT CARGO DOOR	5 - 11	1.80	5 - 5	1.65	5 - 11	1.80	5 - 5	1.65
G	ENTRY DOOR NO 2	10 - 3	3.12	9 - 9	2.97	10 - 3	3.12	9 - 9	2.97
H	STABILIZER	18 - 6	5.64	18 - 0	5.49	18 - 7	5.66	18 - 1	5.51
J	VERTICAL TAIL	41 - 5	12.62	40 - 7	12.37	41 - 5	12.62	40 - 7	12.37

NOTES: CLEARANCES SHOWN ARE NOMINAL. ADD PLUS OR MINUS 3 INCHES TO ACCOUNT FOR VARIATIONS IN LOADING, OLEO AND TIRE PRESSURES, CENTER OF GRAVITY, ETC.

DURING ROUTINE SERVICING, THE AIRPLANE REMAINS RELATIVELY STABLE, PITCH AND ELEVATION CHANGES OCCURRING SLOWLY.

2.3.4 GROUND CLEARANCES
MODEL 737-800, -900,-900ER

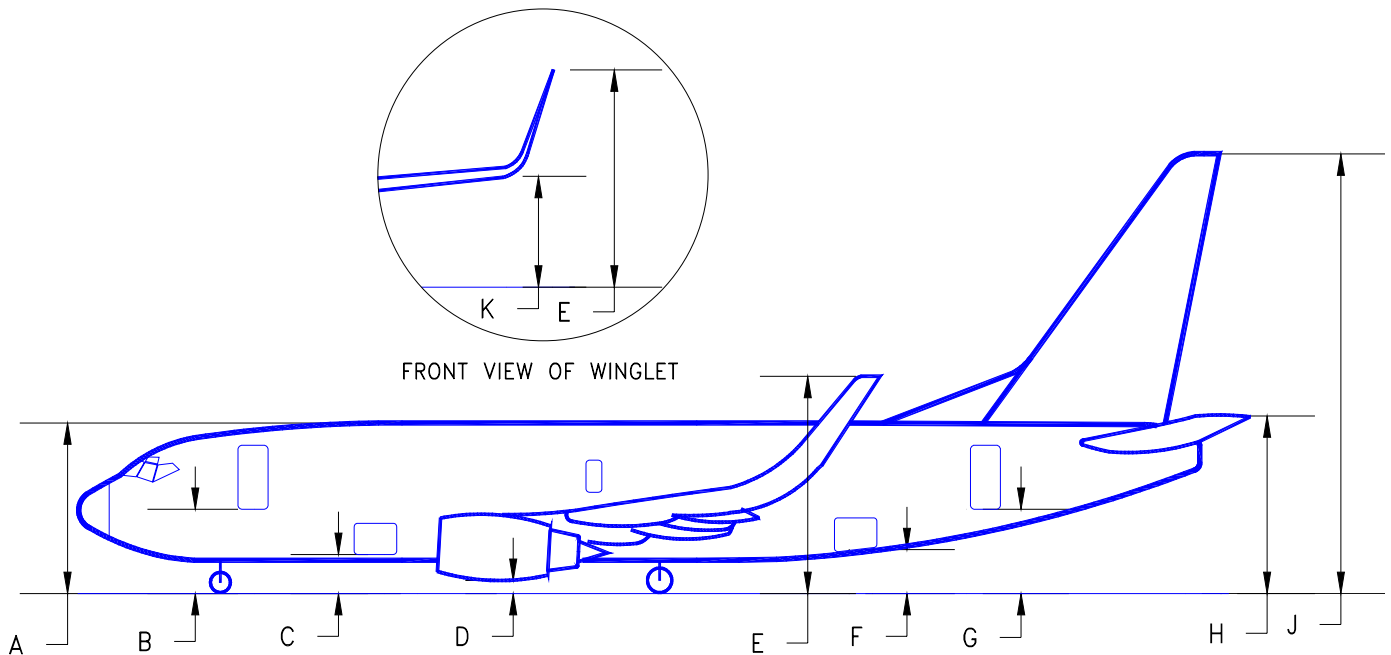

DESCRIPTION	737-700 WITH WINGLETS, BBJ				737-800 WITH WINGLETS, BBJ2				737-900 WITH WINGLETS				
	MAX (OEW)		MIN (MTW)		MAX (OEW)		MIN (MTW)		MAX (OEW)		MIN (MTW)		
	FT - IN	M	FT - IN	M	FT - IN	M	FT - IN	M	FT - IN	M	FT - IN	M	
A	TOP OF FUSELAGE	18 - 3	5.56	17 - 9	5.41	18 - 3	5.56	17 - 9	5.41	18 - 4	5.59	17 - 10	5.41
B	ENTRY DOOR NO 1	9 - 0	2.74	8 - 6	2.59	9 - 0	2.74	8 - 6	2.59	9 - 0	2.74	8 - 6	2.59
C	FWD CARGO DOOR	4 - 9	1.45	4 - 3	1.30	4 - 9	1.45	4 - 3	1.30	4 - 9	1.45	4 - 3	1.30
D	ENGINE	2 - 0	0.61	1 - 6	0.46	2 - 1	0.64	1 - 7	0.48	2 - 1	0.64	1 - 7	0.48
E	WINGTIP	21 - 9	6.63	21 - 3	6.48	22 - 2	6.76	21 - 4	6.50	22 - 2	6.76	21 - 4	6.50
F	AFT CARGO DOOR	5 - 10	1.78	5 - 4	1.63	5 - 11	1.80	5 - 5	1.65	5 - 11	1.80	5 - 5	1.65
G	ENTRY DOOR NO 2	10 - 2	3.10	9 - 8	2.95	10 - 3	3.12	9 - 9	2.97	10 - 3	3.12	9 - 9	2.97
H	STABILIZER	18 - 5	5.61	17 - 11	5.46	18 - 6	5.64	18 - 0	5.49	18 - 7	5.66	18 - 1	5.51
J	VERTICAL TAIL	41 - 7	12.67	40 - 10	12.45	41 - 5	12.62	40 - 7	12.37	41 - 5	12.62	40 - 7	12.37
K	BOTTOM OF WINGLET (APPROX)	13 - 9	4.19	13 - 3	4.04	14 - 2	4.32	13 - 4	4.06	14 - 2	4.32	13 - 4	4.06

NOTES: CLEARANCES SHOWN ARE NOMINAL. ADD PLUS OR MINUS 3 INCHES TO ACCOUNT FOR VARIATIONS IN LOADING, OLEO AND TIRE PRESSURES, CENTER OF GRAVITY, ETC.

DURING ROUTINE SERVICING, THE AIRPLANE REMAINS RELATIVELY STABLE, PITCH AND ELEVATION CHANGES OCCURRING SLOWLY.

2.3.5 GROUND CLEARANCES

MODEL 737-700, -800, -900, -900ER WITH WINGLETS, BBJ, BBJ2

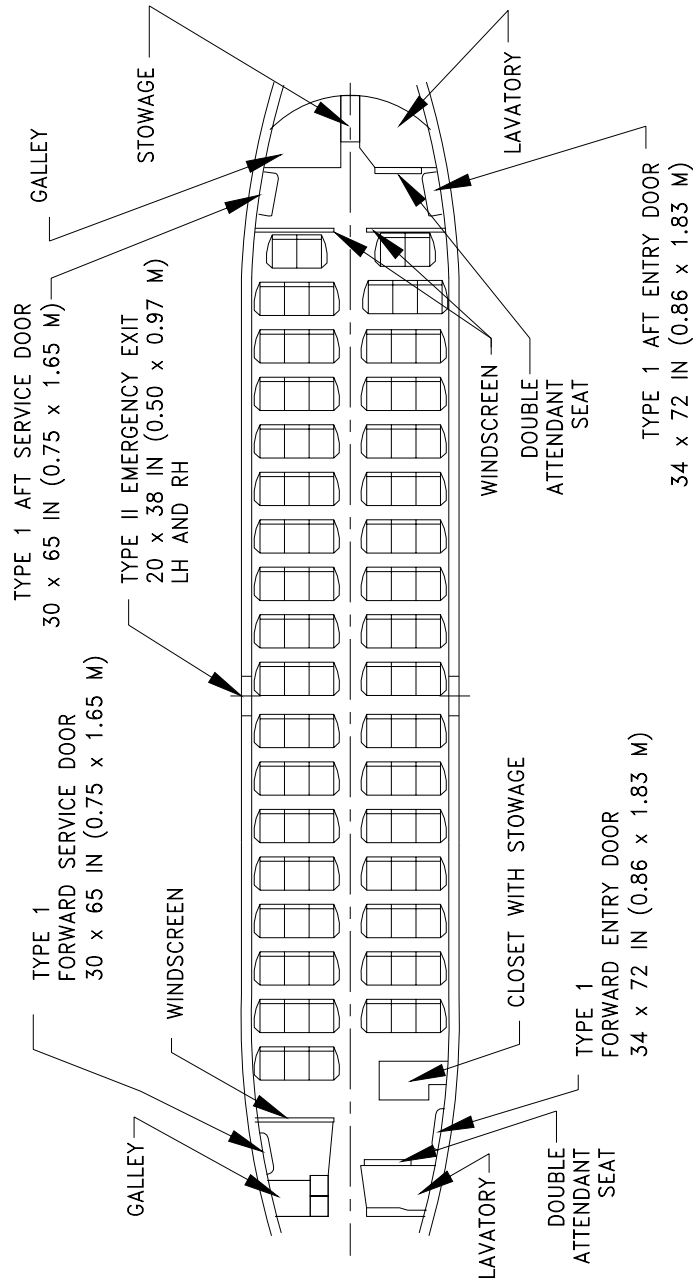

- NOTES:
- * SIX-ABREAST SEATING
 - * 103 PASSENGERS AT 34-IN (0.86 M) PITCH AS SHOWN
 - OR 118 PASSENGERS AT 30-IN (0.76 M) PITCH
 - * GALLEY AFT

2.4.1 INTERIOR ARRANGEMENTS
MODEL 737-100

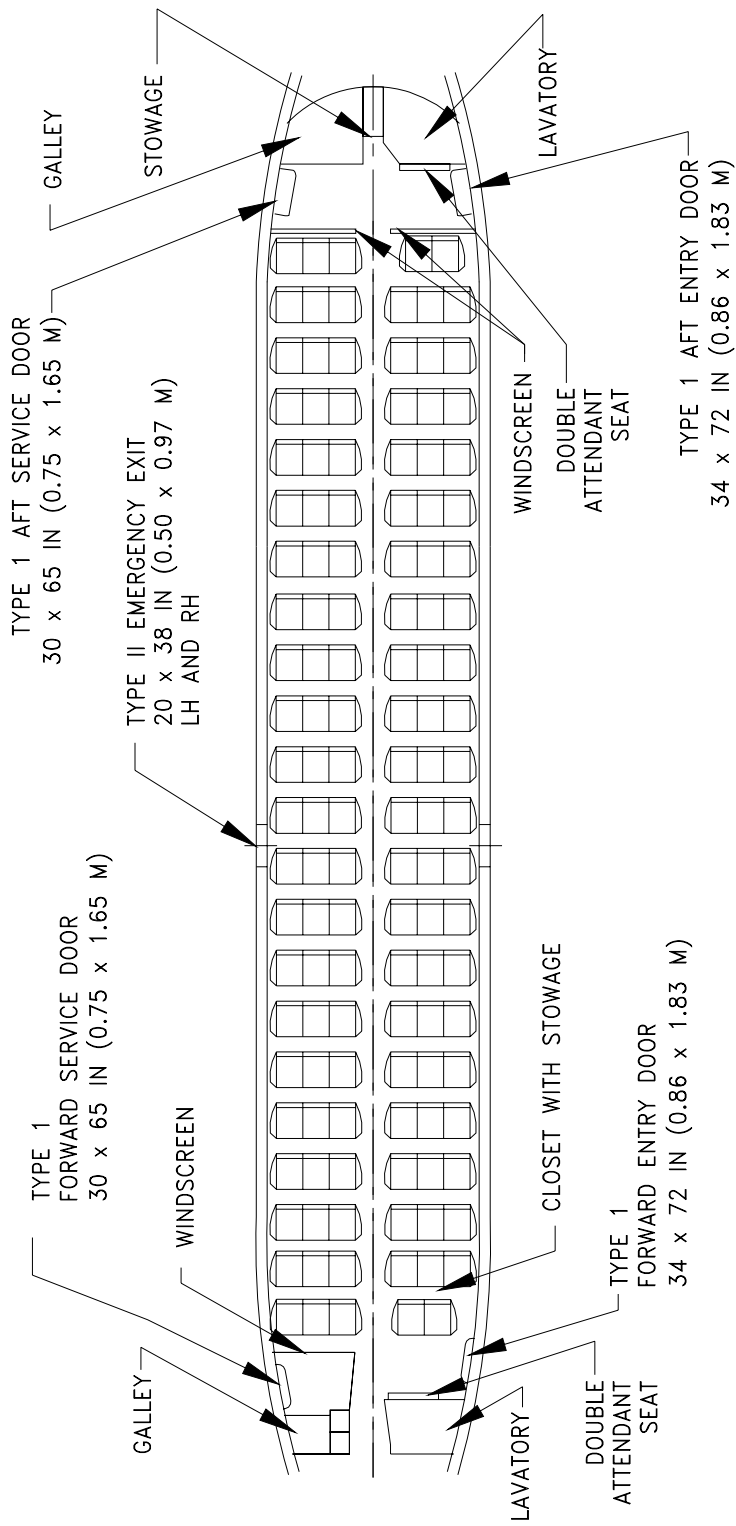

- NOTES:
- * SIX-ABREAST SEATING
 - * 115 PASSENGERS AT 34-IN (0.86 M) PITCH OR 120 PASSENGERS AT 32-IN (0.81 M) PITCH OR 130 PASSENGERS AT 30-IN (0.76 M) PITCH AS SHOWN
 - * GALLEY FORWARD AND AFT

2.4.2 INTERIOR ARRANGEMENTS
MODEL 737-200

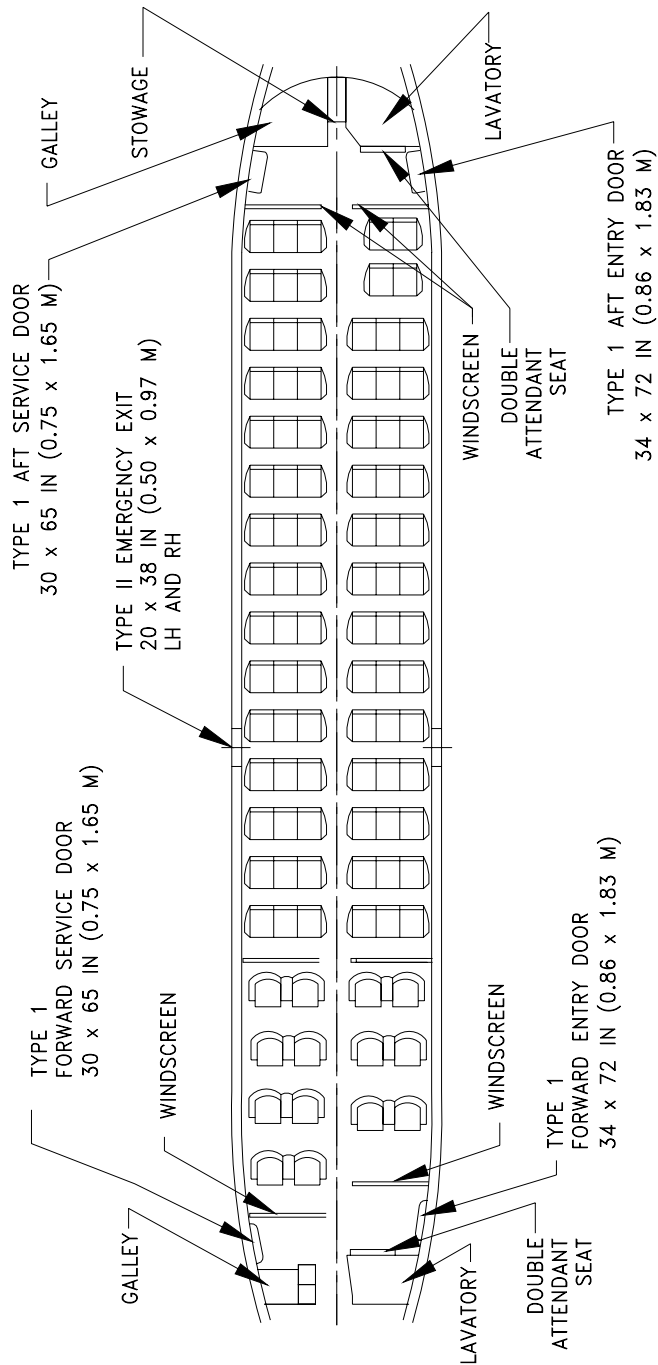

- NOTES:
- * 14 FIRST CLASS PASSENGERS, 4-ABREAST SEATING AT 38-IN (0.97-M) PITCH
 - * 88 ECONOMY CLASS PASSENGERS, 6-ABREAST AT 34-IN (0.86 M) PITCH OR

2.4.3 INTERIOR ARRANGEMENTS – MIXED CLASS
MODEL 737-200

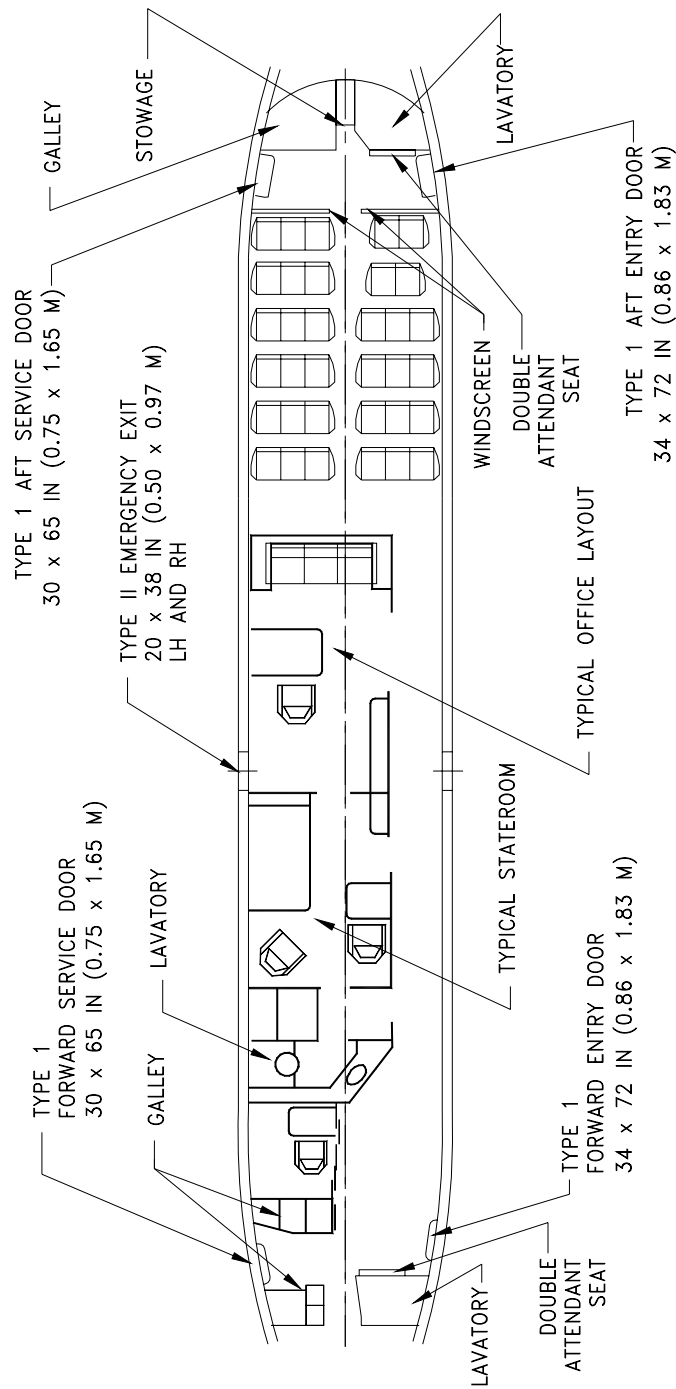

2.4.4 INTERIOR ARRANGEMENTS – EXECUTIVE INTERIOR
MODEL 737-200

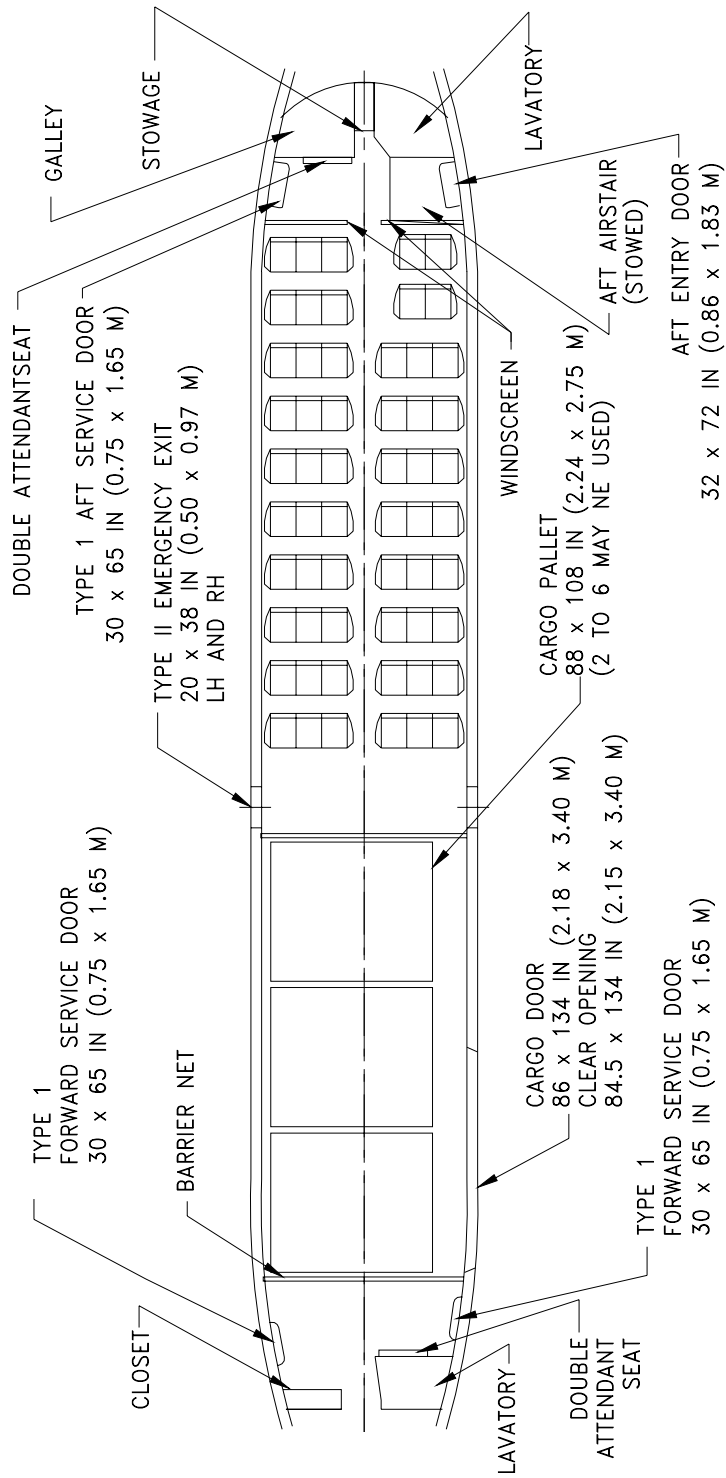

NOTES:

- * 56 PASSENGERS AS SHOWN
- * SIX-ABREAST SEATING AT 34-IN (0.86-M) PITCH
- * THREE CARGO PALLETS

2.4.5 INTERIOR ARRANGEMENTS – PASSENGER/CARGO CONFIGURATION
MODEL 737-200C

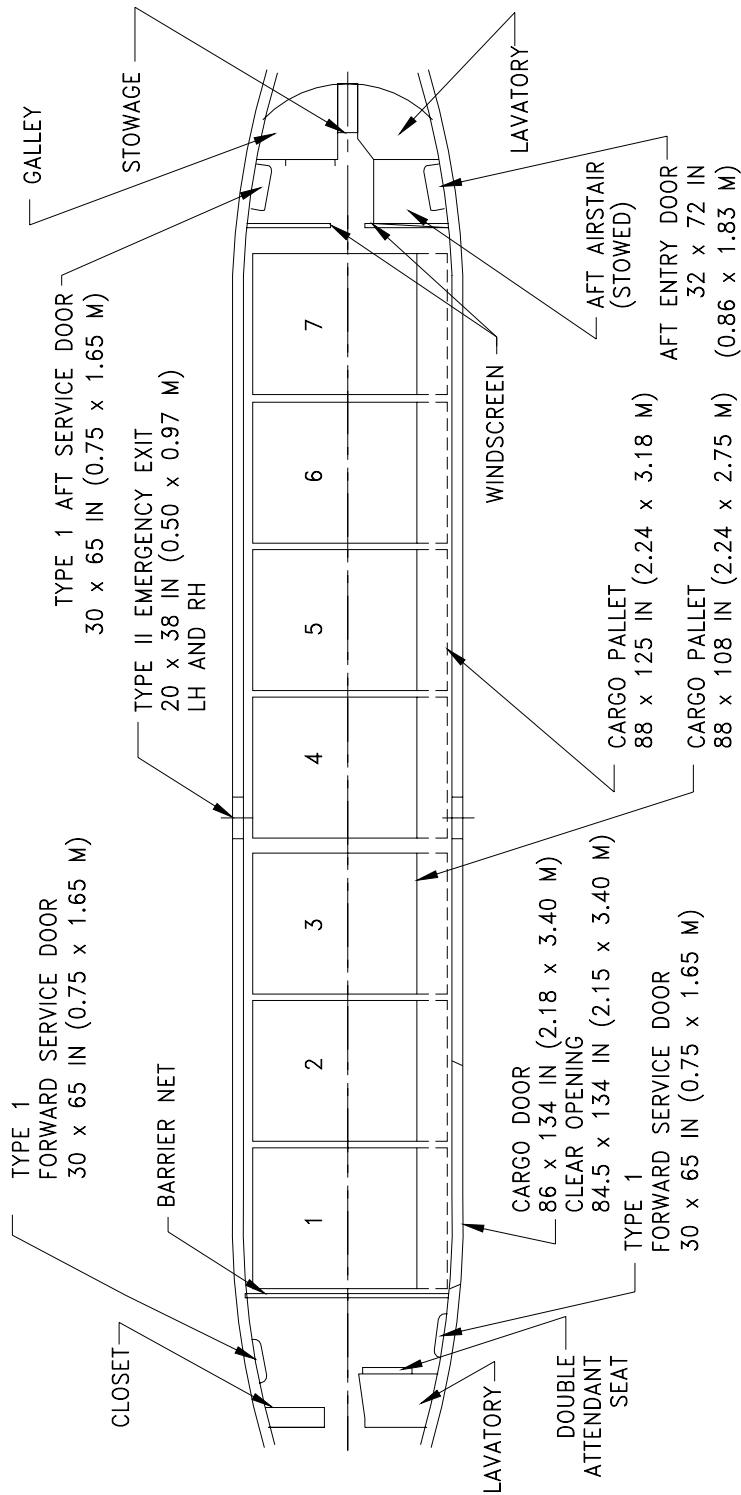

TYPICAL MAIN DECK CARGO VOLUMES				
PALLET SIZE	VOLUME - EACH PALLET		VOLUME - 7 PALLETS	
	"C" SYSTEM	"QC" SYSTEM	"C" SYSTEM	"QC" SYSTEM
88 x 108 IN (2.24 x 2.75 M)	352.5 CU FT (10.0 CU M)	356.4 CU FT (10.1 CU M)	2,468 CU FT (69.9 CU M)	2,495 CU FT (70.0 CU M)
88 x 125 IN (2.24 x 3.18M)	390 CU FT (11.1 CU M)	394.C CU FT (11.2 CU M)	2,730 CU FT (77.4 CU M)	2,762 CU FT (78.3 CU M)

2.4.6 INTERIOR ARRANGEMENTS – ALL-CARGO CONFIGURATION
 MODEL 737-200C

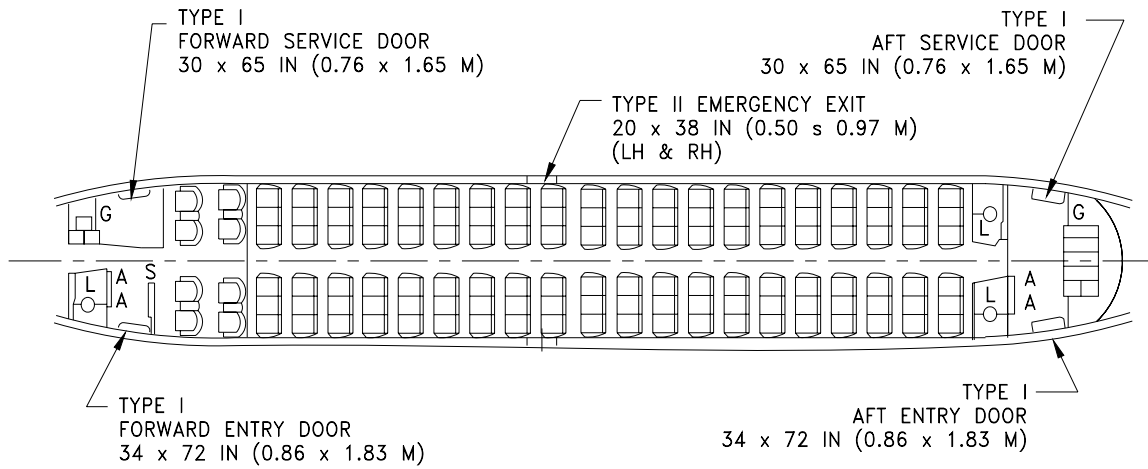

MIXED CLASS
 8 FIRST CLASS SEATS AT 36-IN PITCH
 120 ECONOMY CLASS SEATS AT 32-IN PITCH

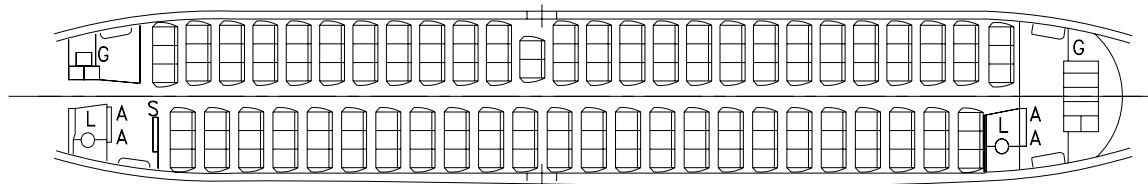

SINGLE CLASS
 149 ECONOMY CLASS SEATS AT 30-IN PITCH

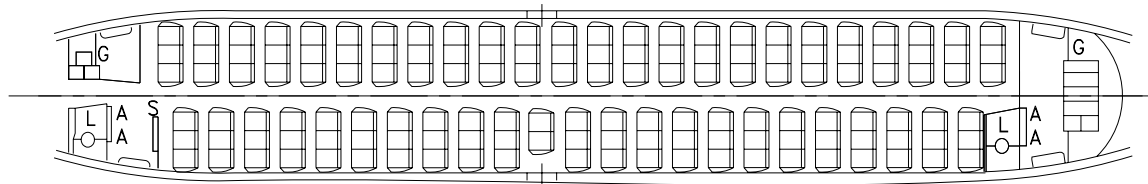

SINGLE CLASS
 140 ECONOMY CLASS SEATS AT 32-IN PITCH

[A] ATTENDANT [C] CLOSET [G] GALLEY [L] LAVATORY [S] STOWAGE

2.4.7 INTERIOR ARRANGEMENTS
 MODEL 737-300

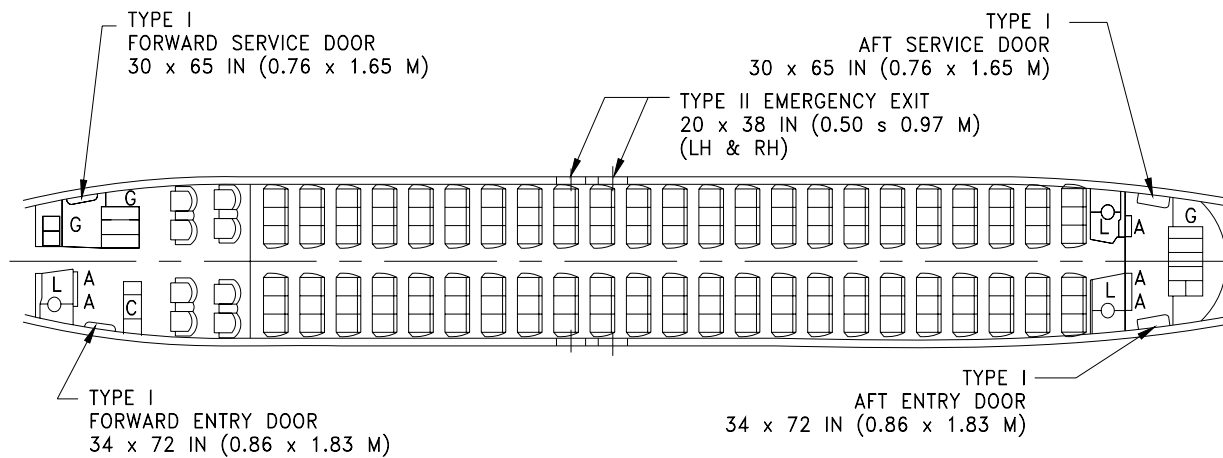

MIXED CLASS
8 FIRST CLASS SEATS AT 36-IN (0.91 M) PITCH
138 ECONOMY CLASS SEATS AT 32-IN (0.81 M) PITCH

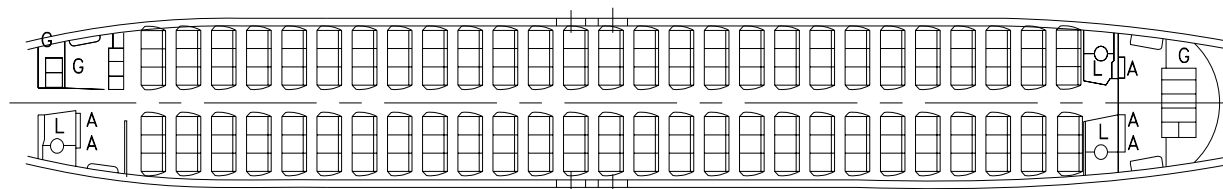

SINGLE CLASS
168 ECONOMY CLASS SEATS AT 30-IN (0.76 M) PITCH

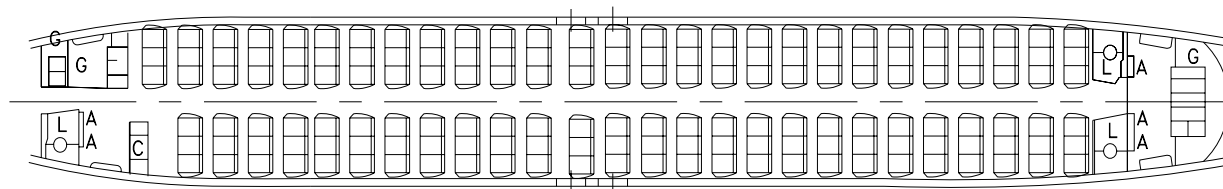

SINGLE CLASS
159 ECONOMY CLASS SEATS AT 32-IN PITCH

[A] ATTENDANT [C] CLOSET [G] GALLEY [L] LAVATORY [S] STOWAGE

2.4.8 INTERIOR ARRANGEMENTS

MODEL 737-400

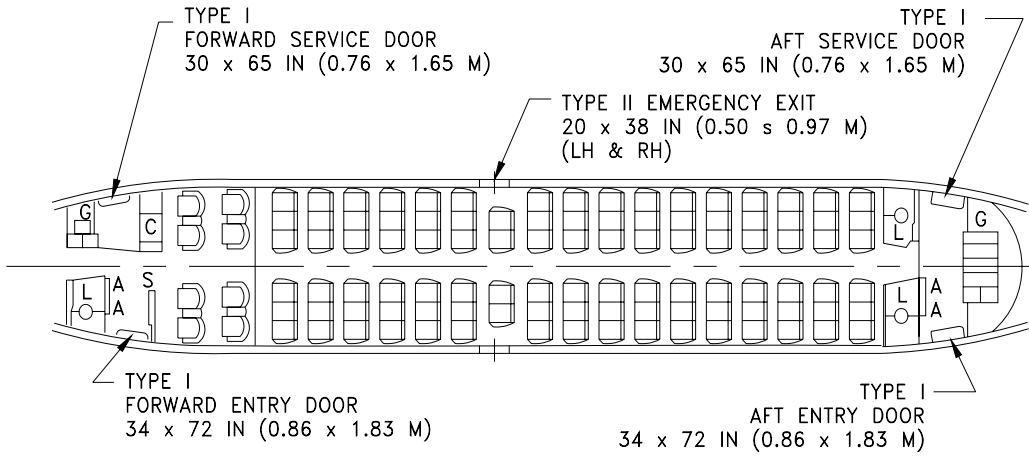

MIXED CLASS
 8 FIRST CLASS SEATS AT 36-IN PITCH
 100 ECONOMY CLASS SEATS AT 32-IN PITCH

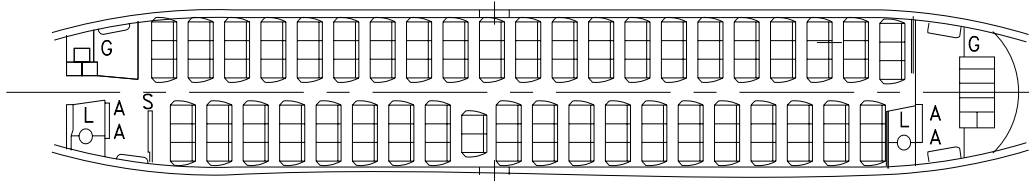

SINGLE CLASS
 122 ECONOMY CLASS SEATS AT 32-IN PITCH

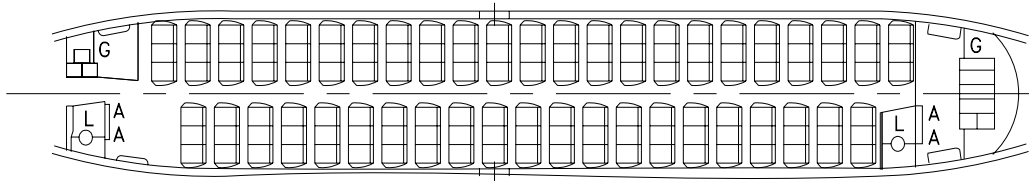

SINGLE CLASS
 132 ECONOMY CLASS SEATS AT 30-IN PITCH

[A] ATTENDANT [C] CLOSET [G] GALLEY [L] LAVATORY [S] STOWAGE

2.4.9 INTERIOR ARRANGEMENTS
MODEL 737-500

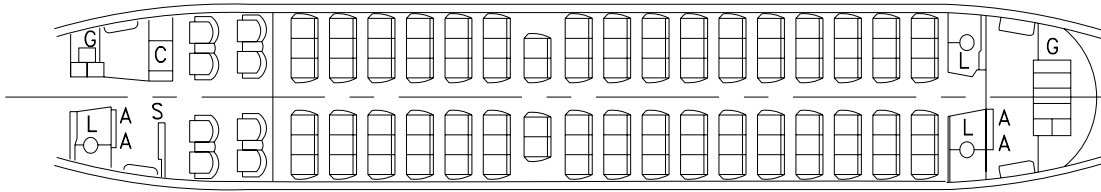

MIXED CLASS
 8 FIRST CLASS SEATS AT 36-IN PITCH
 100 ECONOMY CLASS SEATS AT 32-IN PITCH

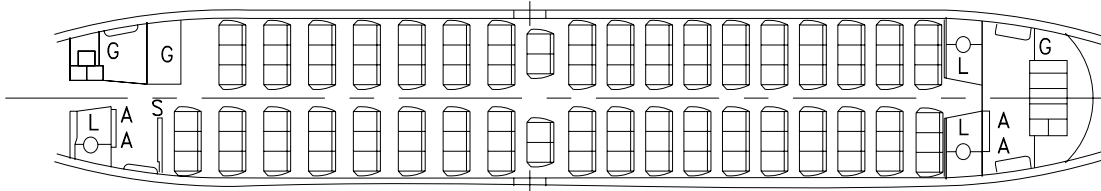

MIXED CLASS
 70 BUSINESS CLASS SEATS AT 34-IN PITCH
 39 ECONOMY CLASS SEATS AT 32-IN PITCH

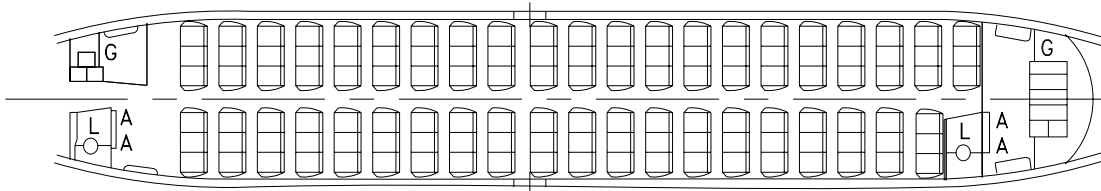

SINGLE CLASS
 123 ECONOMY CLASS SEATS AT 32-IN PITCH (SHOWN)
 OR 130 ECONOMY CLASS SEATS AT 30-IN PITCH

[A] ATTENDANT [C] CLOSET [G] GALLEY [L] LAVATORY [S] STOWAGE

2.4.10 INTERIOR ARRANGEMENTS

MODEL 737-600

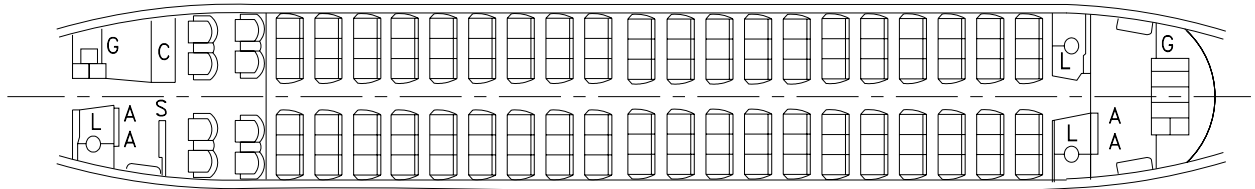

MIXED CLASS
 8 FIRST CLASS SEATS AT 36-IN PITCH
 120 ECONOMY CLASS SEATS AT 32-IN PITCH

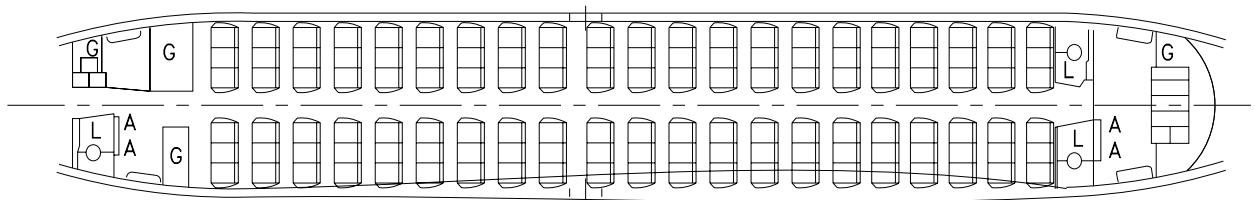

MIXED CLASS
 90 BUSINESS CLASS SEATS AT 34-IN PITCH
 36 ECONOMY CLASS SEATS AT 32-IN PITCH

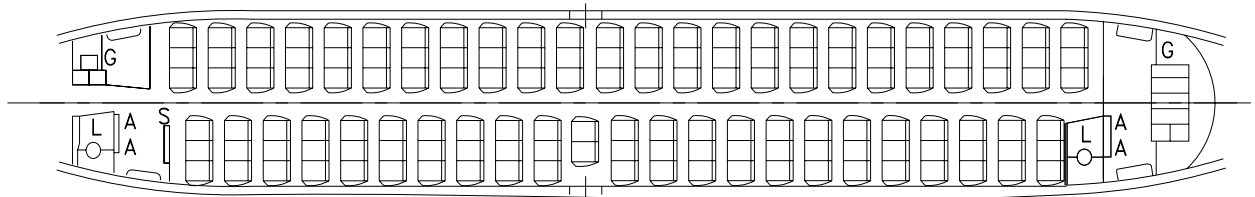

SINGLE CLASS
 140 ECONOMY CLASS SEATS AT 32-IN PITCH (SHOWN)
 OR 148 ECONOMY CLASS SEATS AT 30-IN PITCH

- [A] ATTENDANT
- [C] CLOSET
- [G] GALLEY
- [L] LAVATORY
- [S] STOWAGE

2.4.11 INTERIOR ARRANGEMENTS
MODEL 737-700, -700 WITH WINGLETS

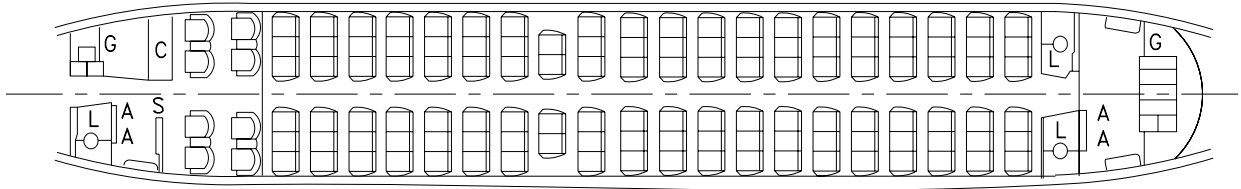

PASSENGER CONFIGURATION – MIXED CLASS
 8 FIRST CLASS SEATS AT 36-IN PITCH
 118 ECONOMY CLASS SEATS AT 32-IN PITCH

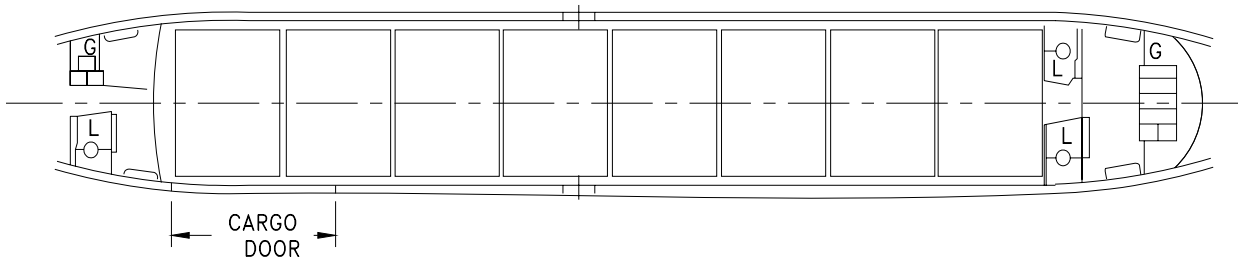

CARGO CONFIGURATION
 EIGHT 88 X 125 IN (2.24 X 3.18 M) PALLETS AS SHOWN
 OR EIGHT 88 X 108 IN (2.24 X 2.64 M)

- [A] ATTENDANT
- [C] CLOSET
- [G] GALLEY
- [L] LAVATORY
- [S] STORAGE

2.4.12 INTERIOR ARRANGEMENTS
MODEL 737-700C

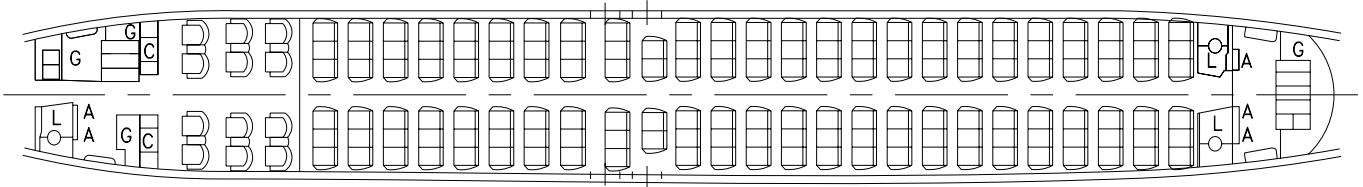

MIXED CLASS
 12 FIRST CLASS SEATS AT 36-IN PITCH
 148 ECONOMY CLASS SEATS AT 32-IN PITCH

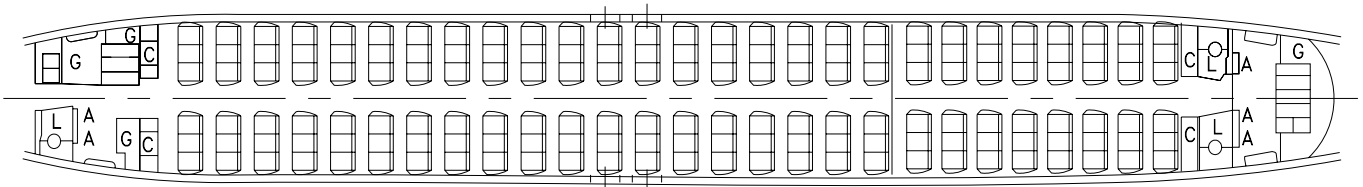

MIXED CLASS
 108 BUSINESS CLASS SEATS AT 34-IN PITCH
 54 ECONOMY CLASS SEATS AT 32-IN PITCH

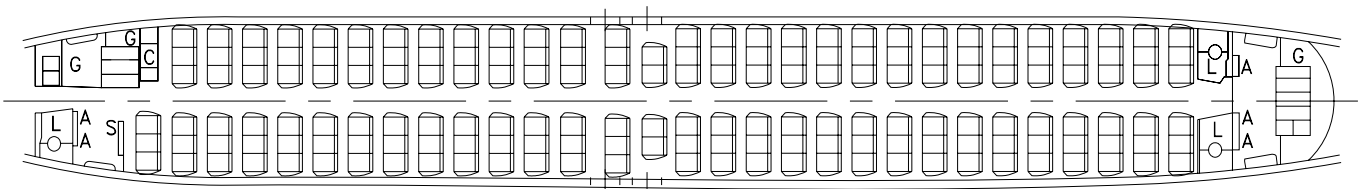

SINGLE CLASS
 175 ECONOMY CLASS SEATS AT 32-IN PITCH (SHOWN)
 OR 184 ECONOMY CLASS SEATS AT 30-IN PITCH

[A] ATTENDANT [C] CLOSET [G] GALLEY [L] LAVATORY [S] STOWAGE

2.4.13 INTERIOR ARRANGEMENTS
MODEL 737-800, -800 WITH WINGLETS

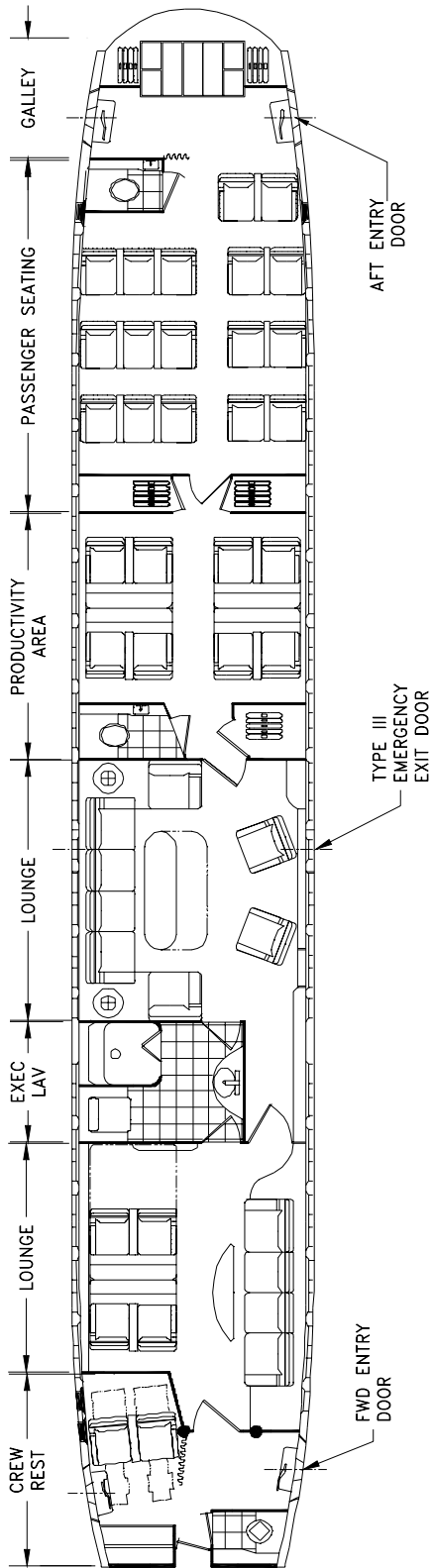

TYPICAL 737 BBJ INTERIOR ARRANGEMENT

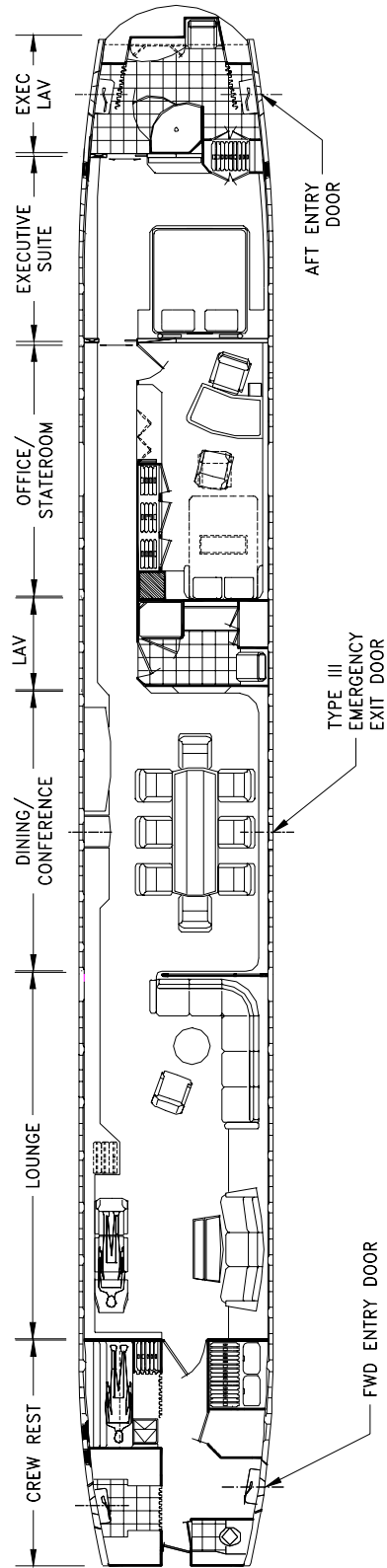

TYPICAL 737 BBJ2 INTERIOR ARRANGEMENT

2.4.14 INTERIOR ARRANGEMENTS
 MODEL 737 BBJ, 737 BBJ2

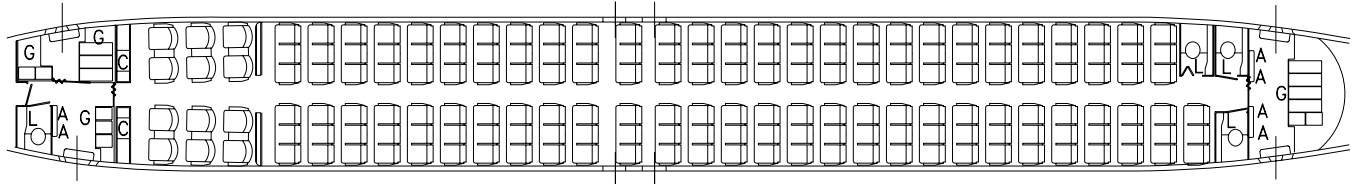

MIXED CLASS
 12 FIRST CLASS SEATS AT 36-IN PITCH
 165 ECONOMY CLASS SEATS AT 32-IN PITCH

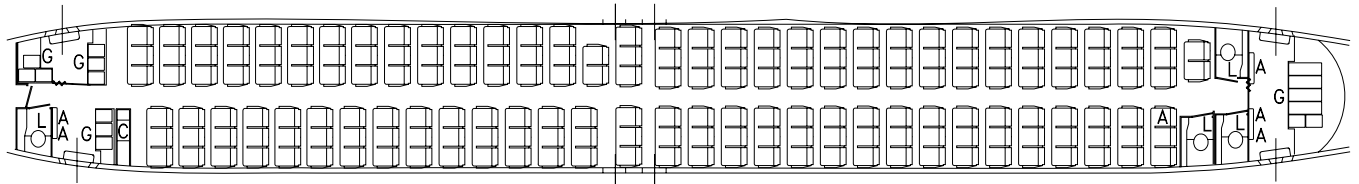

SINGLE CLASS
 177 ECONOMY CLASS SEATS AT 32-IN PITCH (SHOWN)
 OR 189 ECONOMY CLASS SEATS AT 31-IN PITCH

A ATTENDANT

C CLOSET

G GALLEY

L LAVATORY

2.4.15 INTERIOR ARRANGEMENTS
MODEL 737-900, -900 WITH WINGLETS

PRELIMINARY INFORMATION

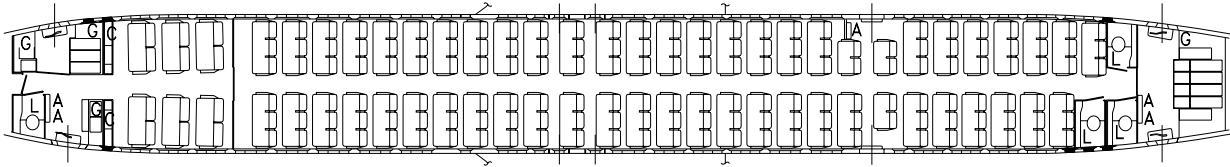

MIXED CLASS

12 FIRST CLASS SEATS AT 36-IN PITCH
162 ECONOMY CLASS SEATS AT 32-IN PITCH

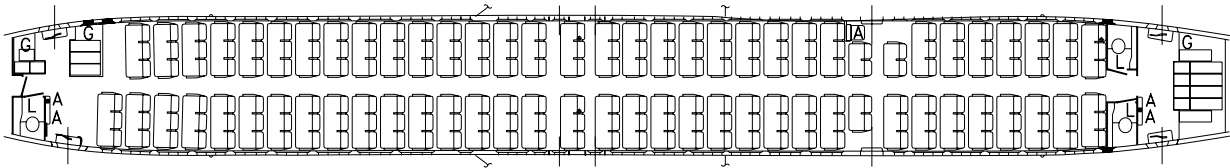

SINGLE CLASS

204 ECONOMY CLASS SEATS AT 30-IN PITCH

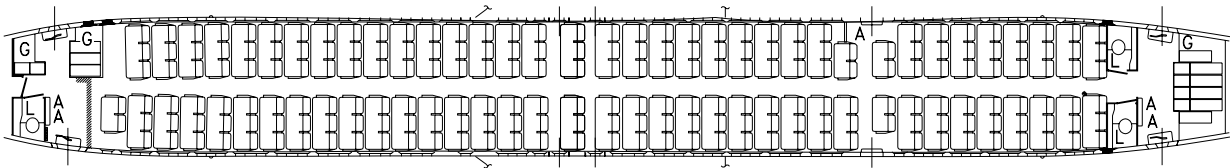

SINGLE CLASS (HIGH-DENSITY SEATING)

215 ECONOMY CLASS SEATS AT 28-IN PITCH

A ATTENDANT **G** GALLEY **L** LAVATORY **C** CLOSET

2.4.16 INTERIOR ARRANGEMENTS

MODEL 737-900ER, 900ER WITH WINGLETS

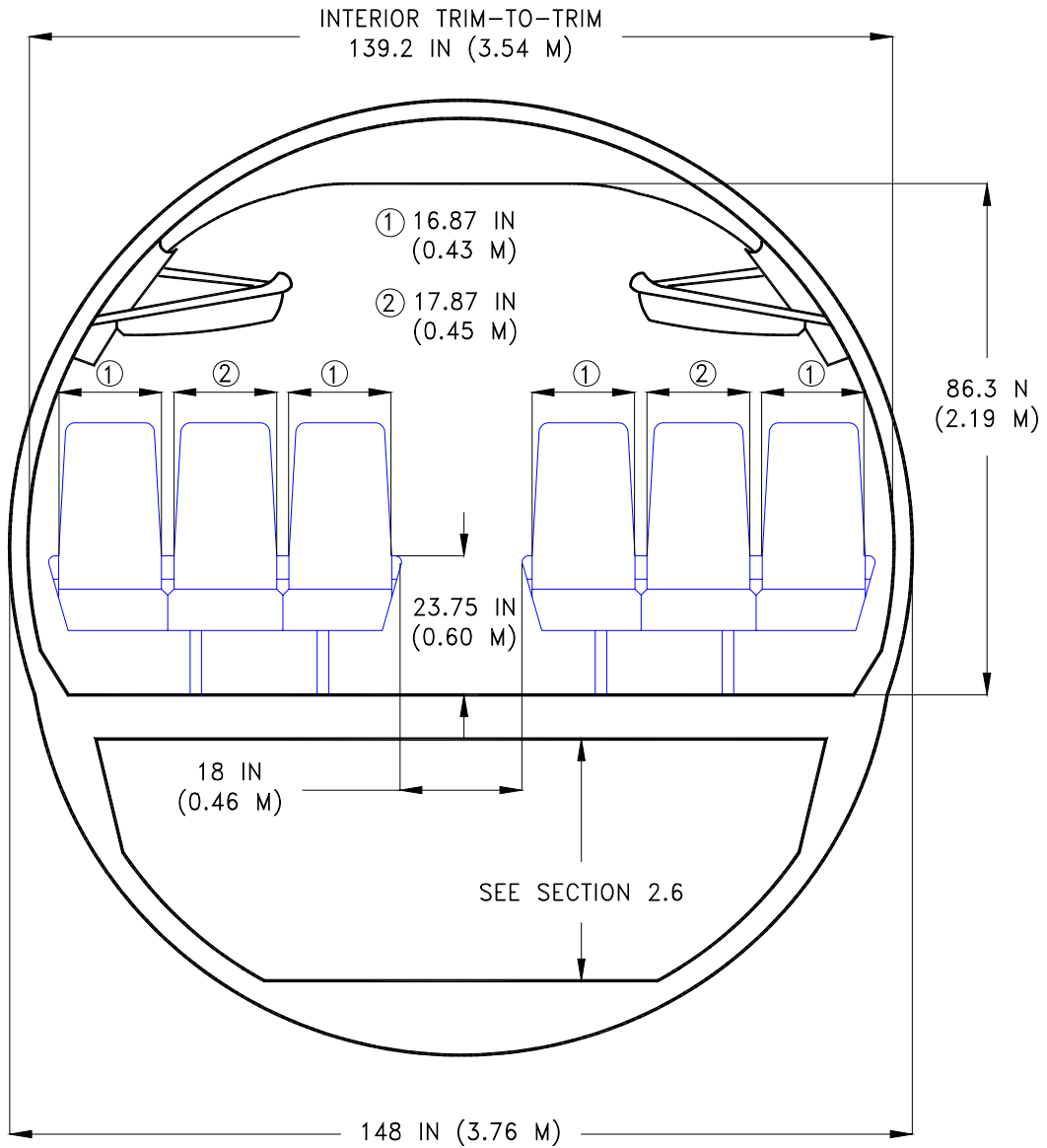

**2.5.1 CABIN CROSS-SECTIONS - SIX-ABREAST SEATING
WITH HATRACK-TYPE STOWAGE SYSTEM**
MODEL 737-100

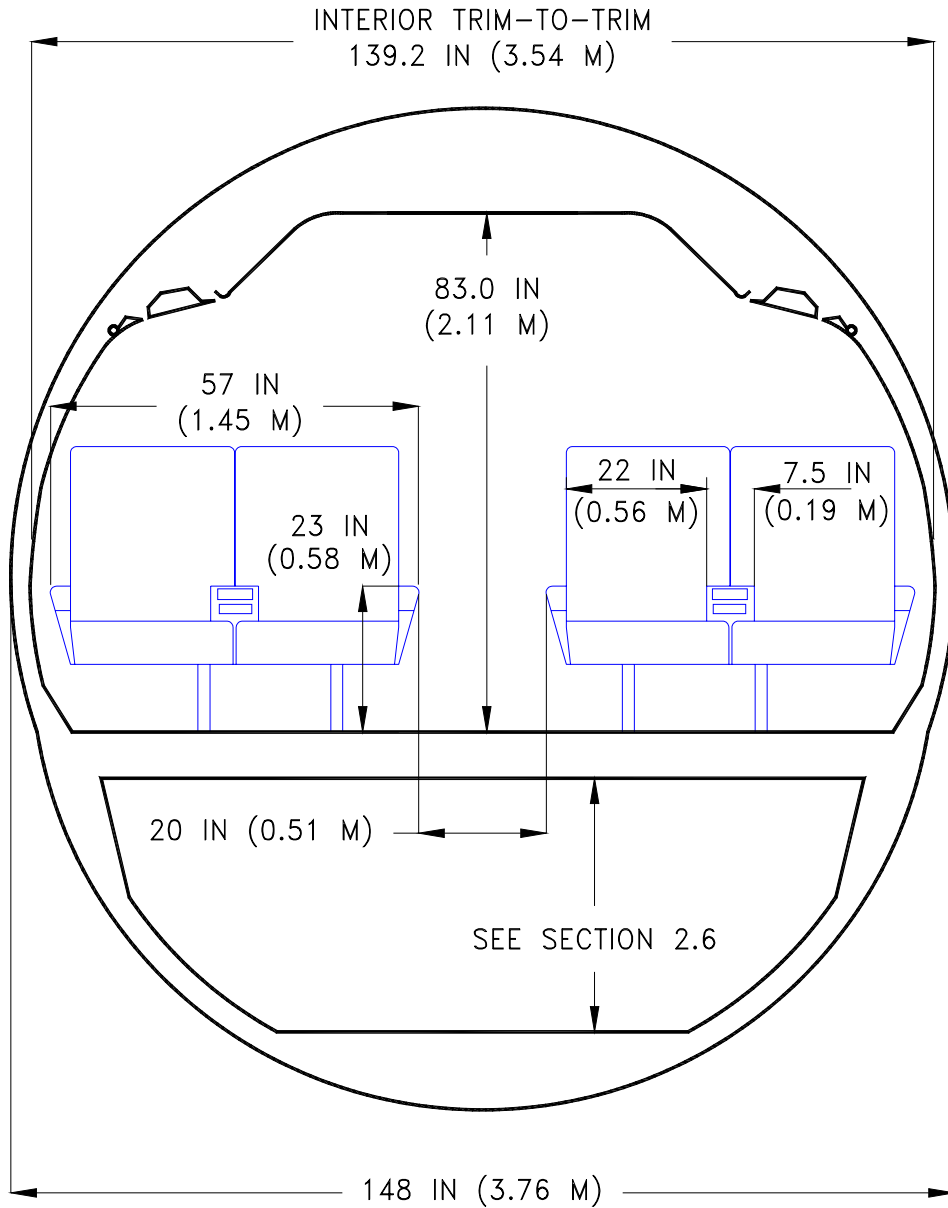

**2.5.2 CABIN CROSS-SECTIONS - FOUR-ABREAST SEATING
WITH "WIDE-BODY LOOK" INTERIOR**
MODEL 737-200

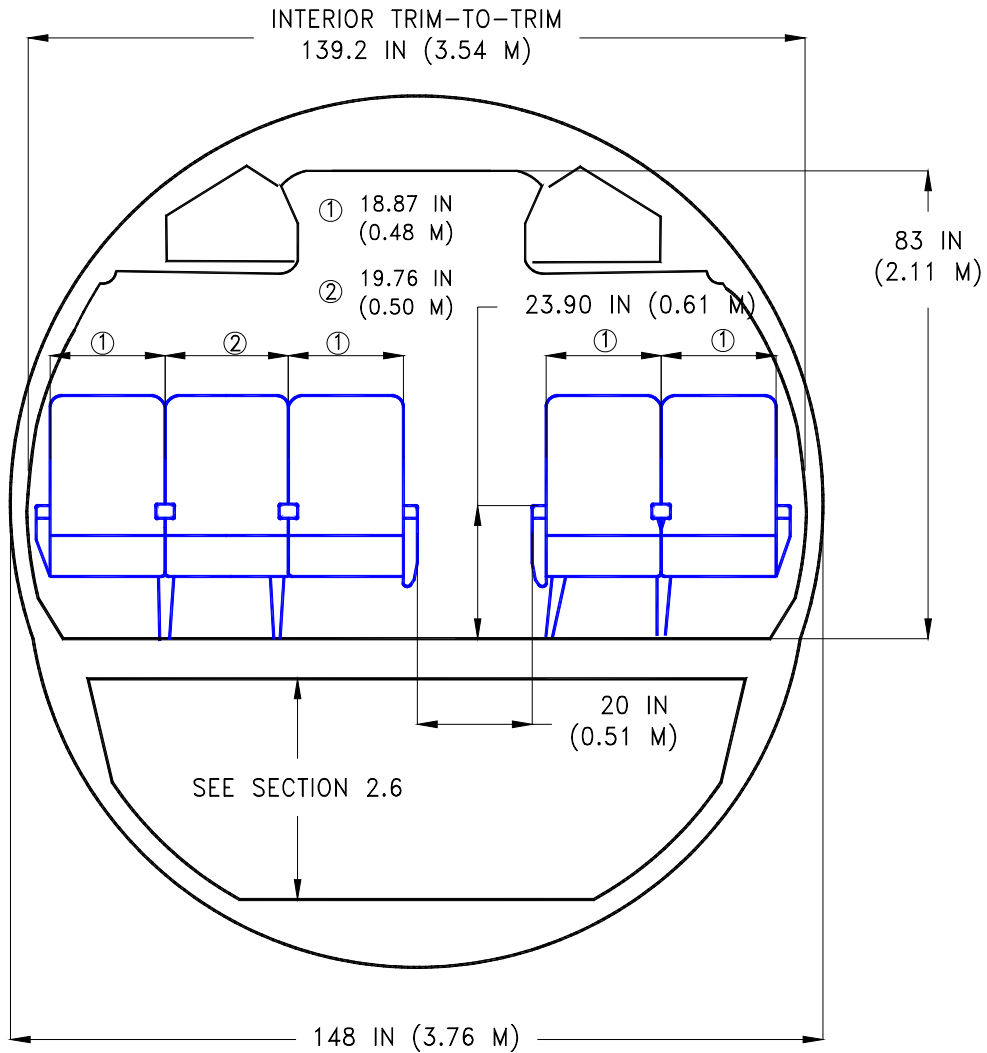

**2.5.3 CABIN CROSS-SECTIONS - FIVE-ABREAST SEATING
WITH CARRYALL COMPARTMENTS**
MODEL 737-200

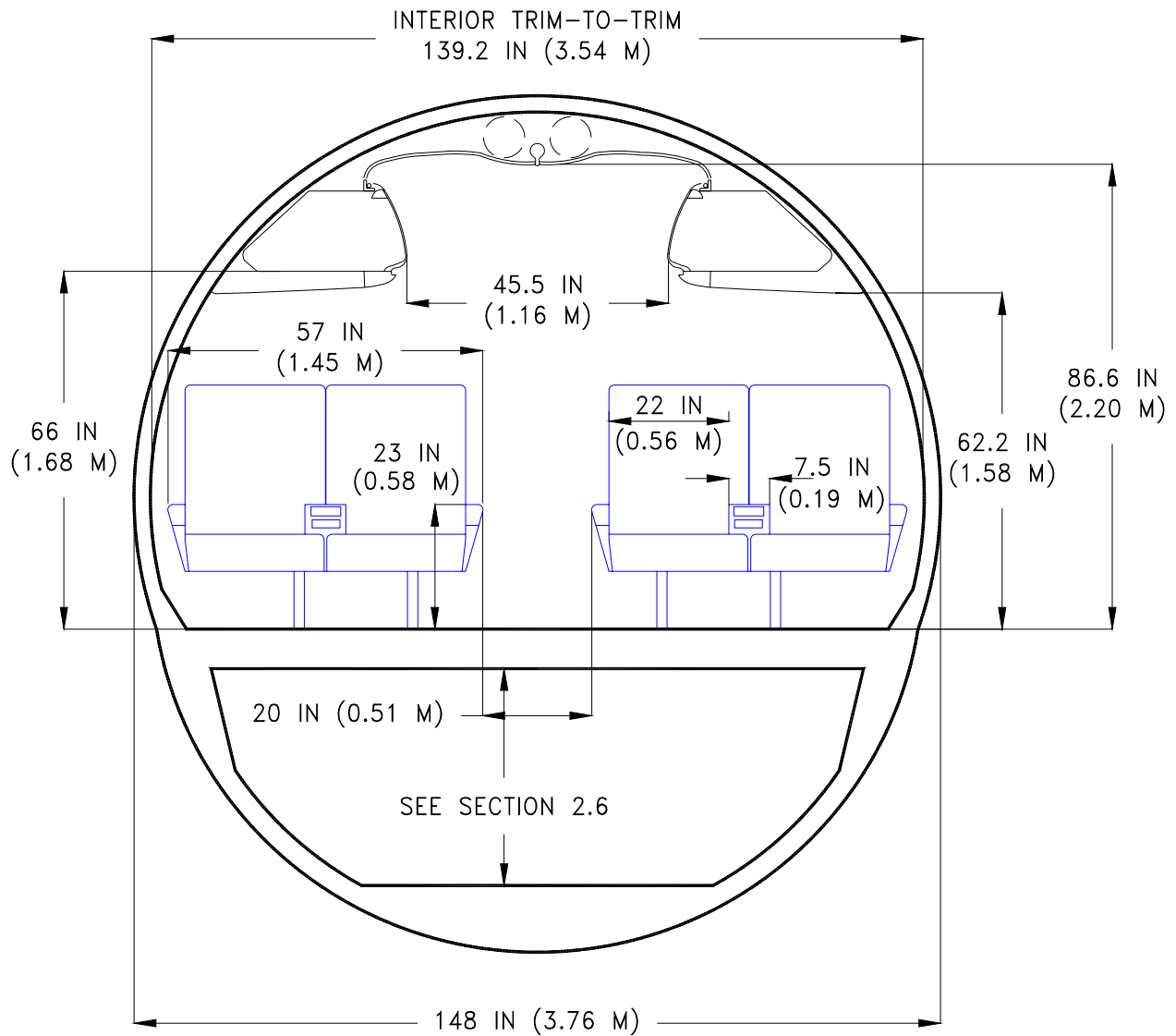

NOTE: CABIN INTERIOR FOR BBJ1 AND BBJ2 AIRPLANES ARE DEPENDENT ON CUSTOMER OPTION.

2.5.4 CABIN CROSS-SECTIONS - FOUR-ABREAST SEATING

*MODEL 737-200 WITH ADVANCED TECHNOLOGY INTERIOR
 MODEL 737-300, -400, -500, -600, -700, -800, -900, BBJ1, BBJ2*

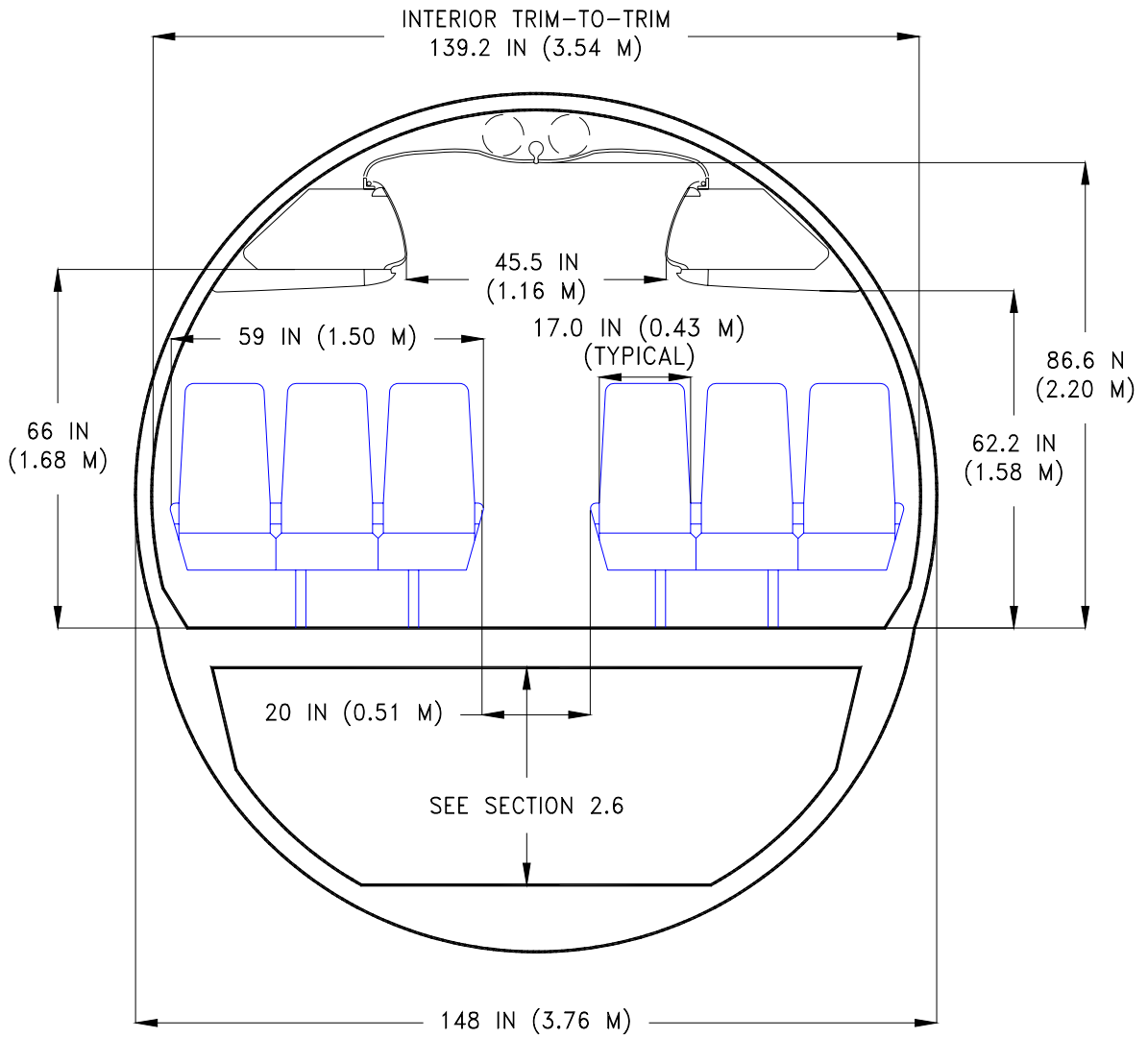

2.5.5 CABIN CROSS-SECTIONS - SIX-ABREAST SEATING
 MODEL 737-200 WITH ADVANCED TECHNOLOGY INTERIOR
 MODEL 737-300, -400, -500, -600, -700, -800, -900

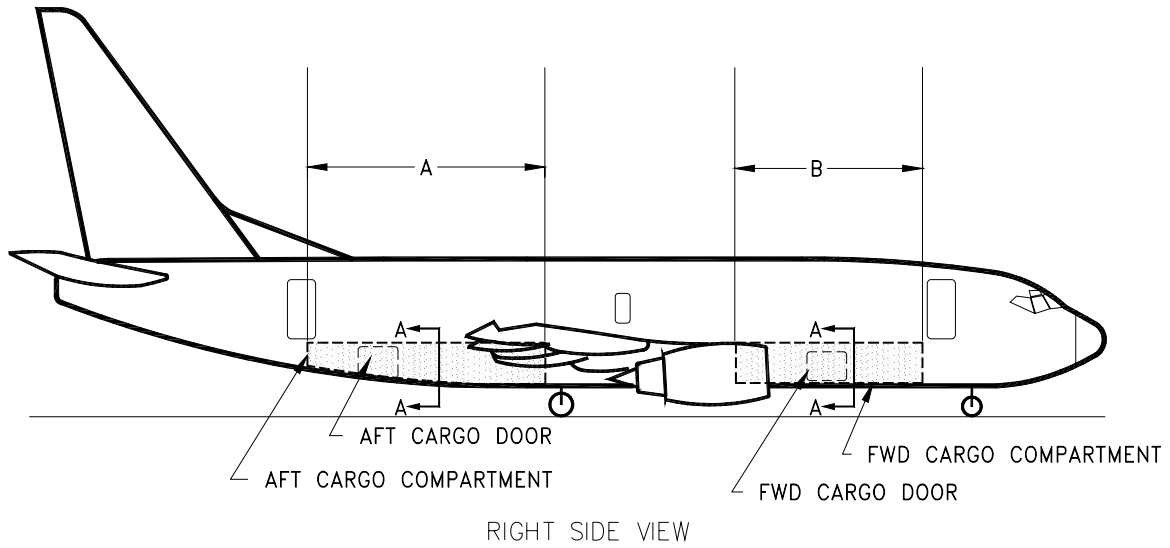

AIRPLANE MODEL	DIMENSION A	DIMENSION B
737-100	18 FT 3 IN (5.56 M)	11 FT 7 IN (3.53 M)
737-200	21 FT 5 IN (6.53 M)	14 FT 7 IN (4.45 M)
737-300	26 FT 5 IN (8.05 M)	16 FT 8 IN (5.08 M)
737-400	30 FT 5 IN (9.27 M)	22 FT 8 IN (6.91 M)
737-500	23 FT 1 IN (7.04 M)	12 FT 2 IN (3.71 M)
737-600	23 FT 0 IN (7.01 M)	10 FT 10 IN (3.30 M)
737-700, BBJ	26 FT 4 IN (8.03 M)	15 FT 4 IN (4.68 M)
737-800, BBJ2	35 FT 8 IN (10.87 M)	25 FT 2 IN (7.67 M)
737-900	39 FT 2 IN (11.94 M)	30 FT 4 IN (9.25 M)

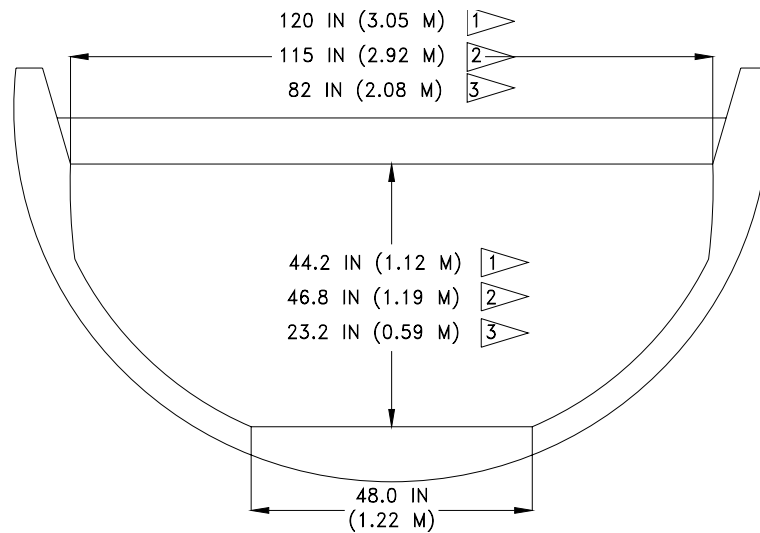

SECTION A-A

- 1 FWD CARGO COMPARTMENT
- 2 AFT CARGO COMPARTMENT, FWD BULKHEAD
- 3 AFT CARGO COMPARTMENT, AFT BULKHEAD

2.6.1 LOWER CARGO COMPARTMENTS - DIMENSIONS
MODEL 737, ALL MODELS

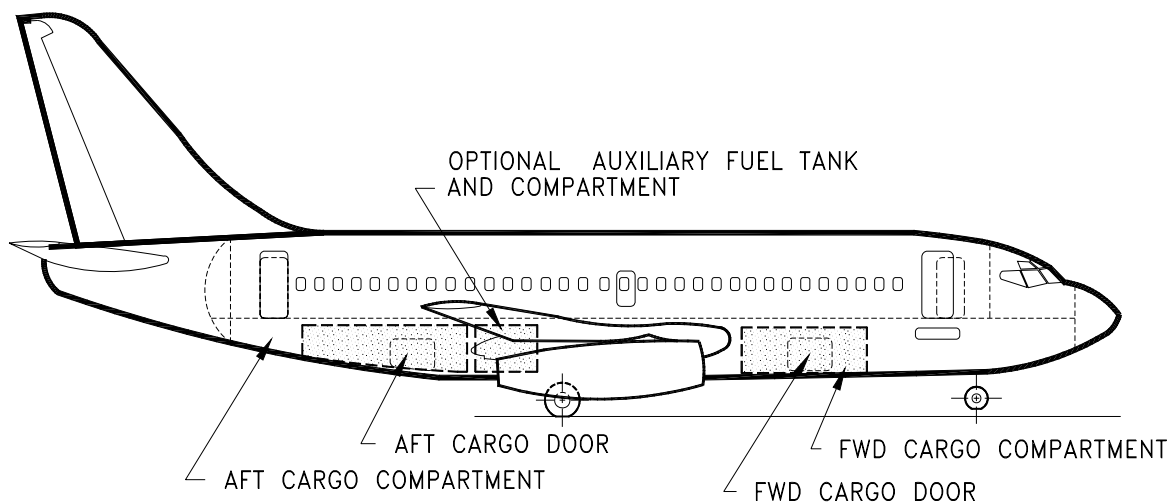

AIRPLANE MODEL	AFT CARGO COMPARTMENT			FORWARD COMPARTMENT BULK CARGO	TOTAL BULK CARGO
	BULK CARGO	AUXILIARY FUEL TANK CAPACITY	AUXILIARY FUEL TANK COMPARTMENT		
737-100	370 CU FT (10.48 CU M)	0	0	280 CU FT (7.93 CU M)	650 CU FT (18.41 CU M)
737-200 AND ADVANCED 737-200	505 CU FT (14.31 CU M)	0	0	370 CU FT (10.48 CU M)	875 CU FT (24.79 CU M)
	370 CU FT (10.48 CU M)	390 GAL (1,475 L)	135 CU FT (3.83 CU M)		740 CU FT (20.96 CU M)
	270 CU FT (7.65 CU M)	810 GAL (3,065 L)	235 CU FT (6.66 CU M)		640 CU FT (18.13 CU M)

2.6.2 LOWER CARGO COMPARTMENTS - CAPACITIES

MODEL 737-100, -200

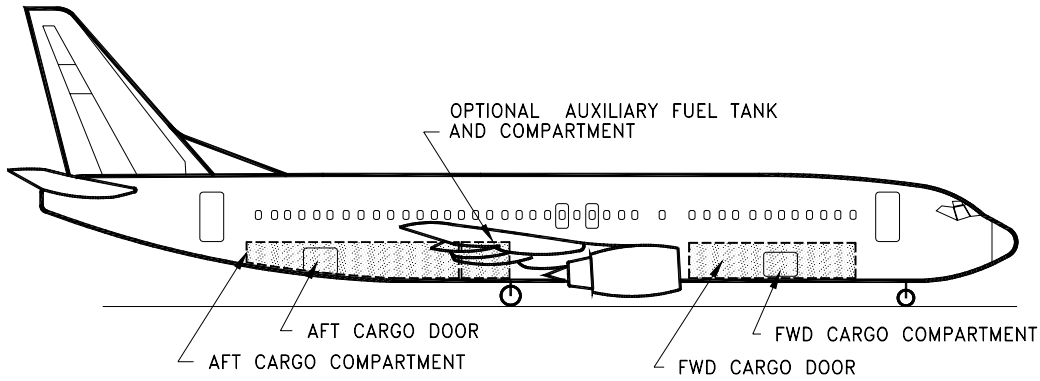

AIRPLANE MODEL	AFT CARGO COMPARTMENT			FORWARD COMPARTMENT BULK CARGO	TOTAL BULK CARGO	NOTES
	BULK CARGO	AUXILIARY FUEL TANK CAPACITY	AUXILIARY FUEL TANK COMPARTMENT CAPACITY			
737-300	643 CU FT (18.2 CU M)	0	0	425 CU FT (12.0 CU M)	1,068 CU FT (30.2 CU M)	(1)
	504 CU FT (14.3 CU M)	390 GAL (1,475 L)	139 CU FT (3.9 CU M)		929 CU FT (26.3 CU M)	(2)
	416 CU FT (11.8 CU M)	810 GAL (3,065 L)	227 CU FT (6.4 CU M)		841 CU FT (23.8 CU M)	(2)
	492 CU FT (13.9 CU M)	500 GAL (1,893 L)	151 CU FT (5.3 CU M)		917 CU FT (26.0 CU M)	(3)
	367 CU FT (10.4 CU M)	1,000 GAL (3,785 L)	276 CU FT (7.8 CU M)		792 CU FT (22.4 CU M)	(3)
737-400	766 CU FT (21.7 CU M)	0	0	607 CU FT (17.2 CU M)	1,373 CU FT (38.9 CU M)	(1)
	627 CU FT (17.7 CU M)	390 GAL (1,475 L)	139 CU FT (3.9 CU M)		1,234 CU FT (34.9 CU M)	(2)
	539 CU FT (15.3 CU M)	810 GAL (3,065 L)	227 CU FT (6.4 CU M)		1,146 CU FT (32.4 CU M)	(2)
	615 CU FT (17.4 CU M)	500 GAL (1,893 L)	151 CU FT (5.3 CU M)		1,222 CU FT (34.6 CU M)	(3)
	490 CU FT (13.9 CU M)	1,000 GAL (3,785 L)	276 CU FT (7.8 CU M)		1,097 CU FT (31.0 CU M)	(3)
737-500	535 CU FT (15.1 CU M)	0	0	287 CU FT (8.1 CU M)	822 CU FT (233.3 CU M)	(1)
	396 CU FT (11.2 CU M)	390 GAL (1,475 L)	139 CU FT (3.9 CU M)		683 CU FT (19.3 CU M)	(2)
	308 CU FT (8.7 CU M)	810 GAL (3,065 L)	227 CU FT (6.4 CU M)		595 CU FT (16.8 CU M)	(2)
	384 CU FT (10.9 CU M)	500 GAL (1,893 L)	151 CU FT (5.3 CU M)		671 CU FT (19.0 CU M)	(3)
	259 CU FT (7.3 CU M)	1,000 GAL (3,785 L)	276 CU FT (7.8 CU M)		546 CU FT (15.5 CU M)	(3)

NOTES (1) WITHOUT AUXILIARY FUEL TANK
(2) WITH BOEING-INSTALLED AUXILIARY FUEL TANK
(3) WITH ROGERSON-INSTALLED AUXILIARY FUEL TANK

2.6.3 LOWER CARGO COMPARTMENTS - CAPACITIES
MODEL 737-300, -400, -500

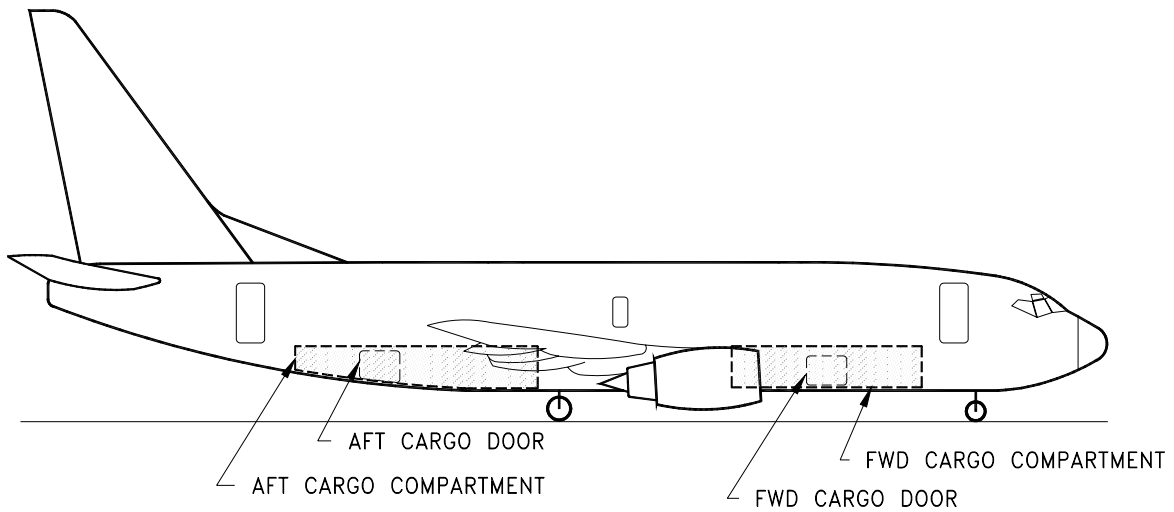

AIRPLANE MODEL	AFT CARGO COMPARTMENT			FORWARD COMPARTMENT BULK CARGO	TOTAL BULK CARGO	NOTES
	BULK CARGO	AUXILIARY FUEL TANK CAPACITY	AUXILIARY FUEL TANK COMPARTMENT CAPACITY			
737-600	488 CU FT (13.8 CU M)	0	0	268 CU FT (7.6 CU M)	756 CU FT (21.4 CU M)	(1)
737-700	596 CU FT (16.9 CU M)	0	0	406 CU FT (11.5 CU M)	1,002 CU FT (28.4 CU M)	(1)
737-800	899 CU FT (25.5 CU M)	0	0	692 CU FT (19.6 CU M)	1,591 CU FT (45.1 CU M)	(1)
737-900	1,012 CU FT (28.7 CU M)	0	0	840 CU FT (23.8 CU M)	1,852 CU FT (52.5 CU M)	(1)
737-900ER	996 CU FT (28.2 CU M)	0	0	830 CU FT (23.5 CU M)	1,826 CU FT (51.7 CU M)	(2)
737-900ER	843 CU FT (23.9 CU M)	520 GAL (1,968 L)	153 CU FT (4.3 CU M)	830 CU FT (23.5 CU M)	1,673 CU FT (47.7 CU M)	(3)
737-900ER	755 CU FT (21.4 CU M)	962 GAL (3,641 L)	241 CU FT (6.8 CU M)	830 CU FT (23.5 CU M)	1,585 CU FT (44.9 CU M)	(4)

NOTES:

- (1) NO AUXILIARY FUEL TANK
- (2) USEABLE CAPACITY, NO AUXILIARY FUEL TANK – PRELIMINARY ESTIMATES
- (3) USEABLE CAPACITY, WITH ONE AUXILIARY FUEL TANK – PRELIMINARY ESTIMATES
- (4) USEABLE CAPACITY, WITH TWO AUXILIARY FUEL TANKS – PRELIMINARY ESTIMATES

2.6.4 LOWER CARGO COMPARTMENTS - CAPACITIES

MODEL 737-600, -700, -800, -900, -900ER WITH AND WITHOUT WINGLETS

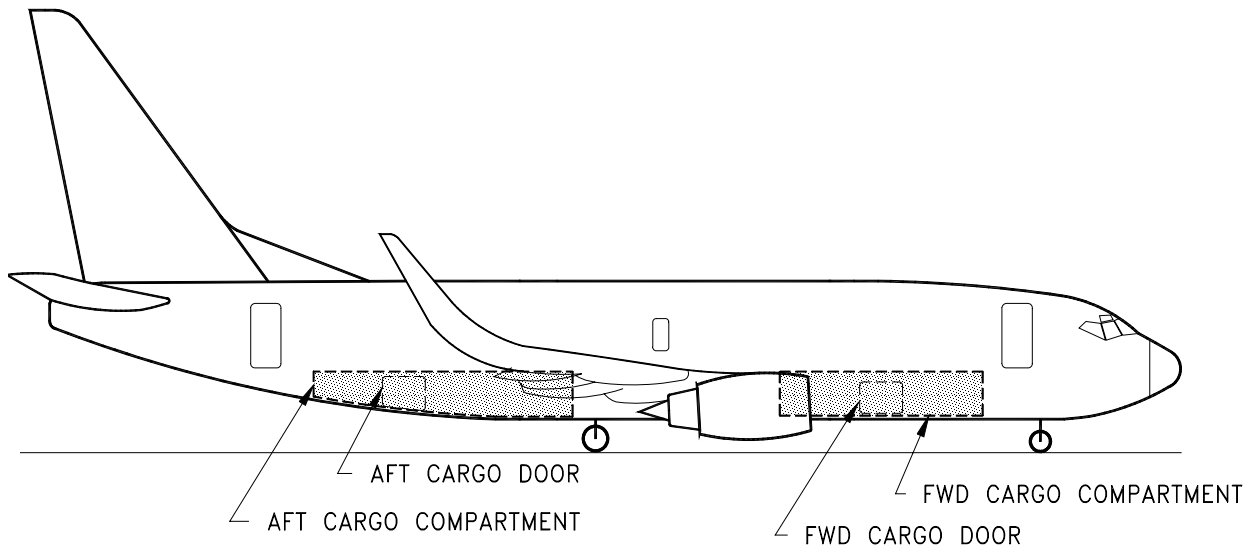

AIRPLANE MODEL	FWD CARGO COMPARTMENT			AFT CARGO COMPARTMENT			TOTAL CARGO	
	NO OF FUEL TANKS	CAPACITY AVAILABLE		NO OF FUEL TANKS	CAPACITY AVAILABLE		CAPACITY AVAILABLE	
		CU FT	CU M		CU FT	CU M	CU FT	CU M
737 BBJ	0	377	10.7	3	234	6.6	611	17.3
	0	377	10.7	4	138	3.9	515	14.6
	2	181	5.1	3	234	6.6	415	11.7
	2	181	5.1	4	138	3.9	319	9.0
	2	181	5.1	5	87	2.5	268	7.6
	3	127	3.6	5	87	2.5	214	6.1
	4	73	2.1	5	87	2.5	160	4.6
737 BBJ2	0	985	27.9	3	561	15.9	1,546	43.8
	0	985	27.9	3	454	12.8	1,423	40.3
	0	985	27.9	5	346	9.8	1,331	37.7
	1	662	18.8	3	561	15.9	1,224	34.7
	1	662	18.8	4	454	12.8	1,116	31.6
	2	468	13.3	3	561	15.9	1,029	29.2
	2	468	13.3	4	454	12.8	922	26.1
	2	468	13.3	5	346	9.8	814	23.1

2.6.5 LOWER CARGO COMPARTMENTS - CAPACITIES
MODEL 737 BBJ, 737 BBJ2

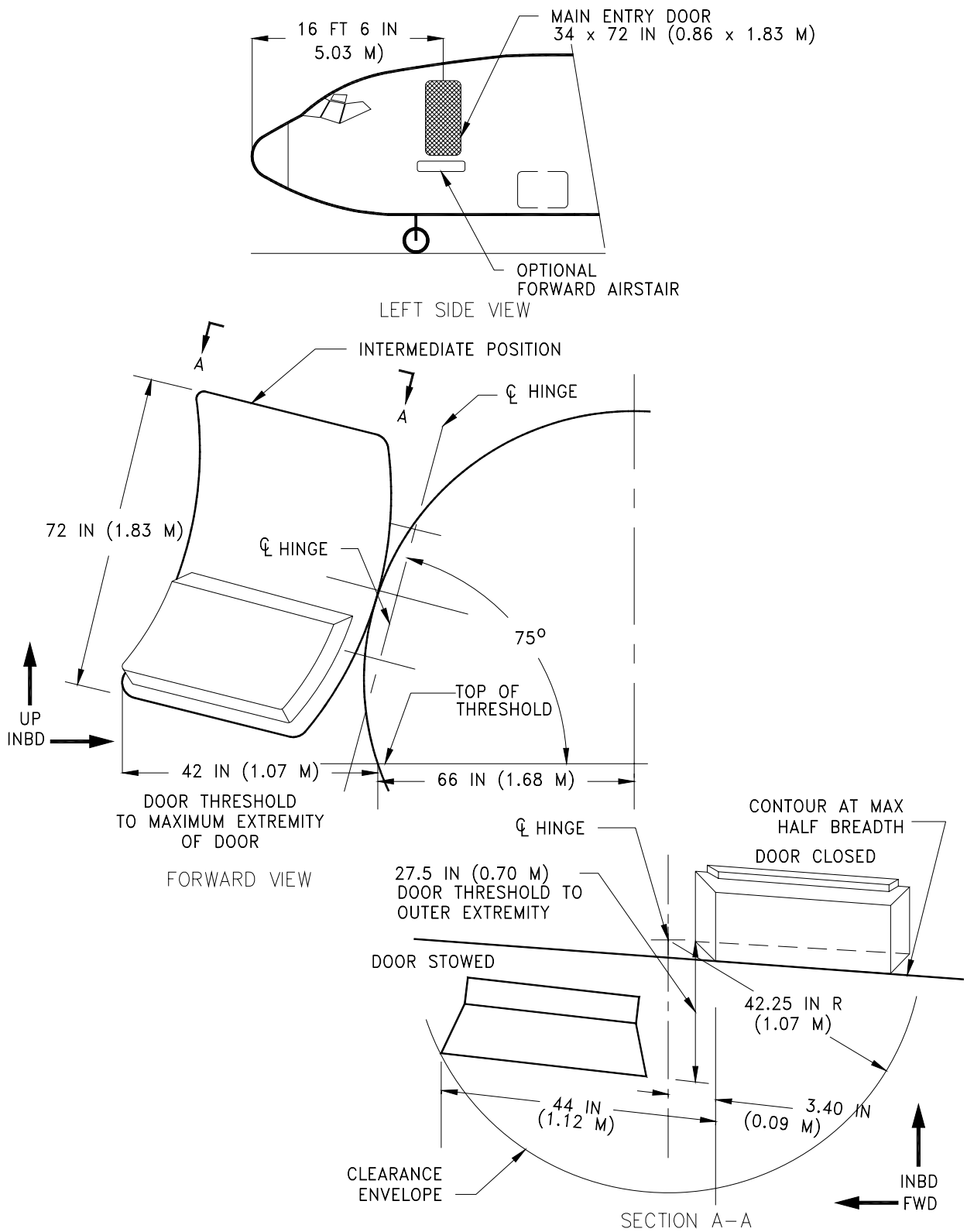

2.7.1 DOOR CLEARANCES - FORWARD MAIN ENTRY DOOR NO. 1
MODEL 737, ALL MODELS

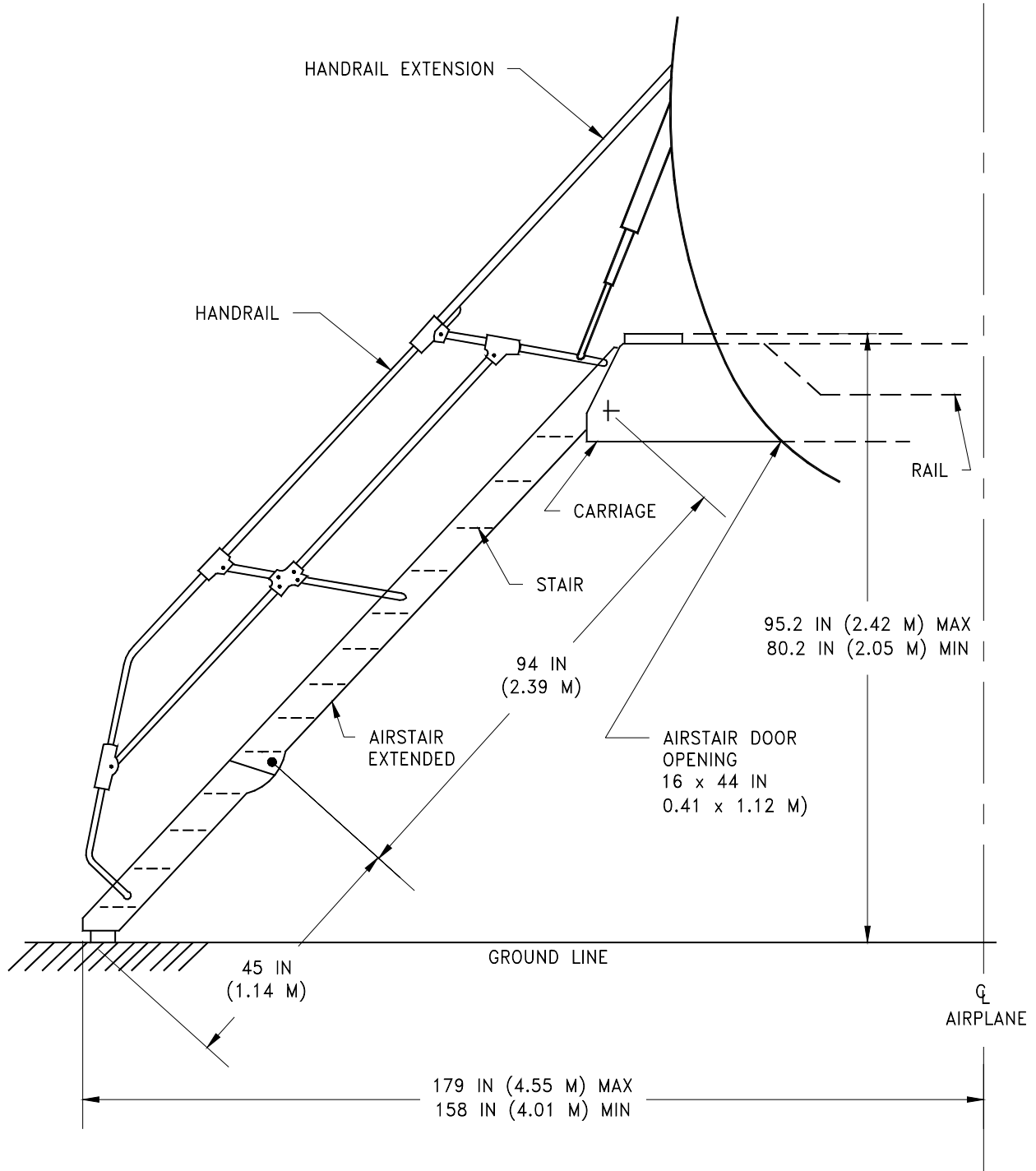

2.7.2 DOOR CLEARANCES – OPTIONAL FORWARD AIRSTAIRS, MAIN ENTRY DOOR NO 1
 MODEL 737-100, -200, -300, -400, -500

D6-58325-6

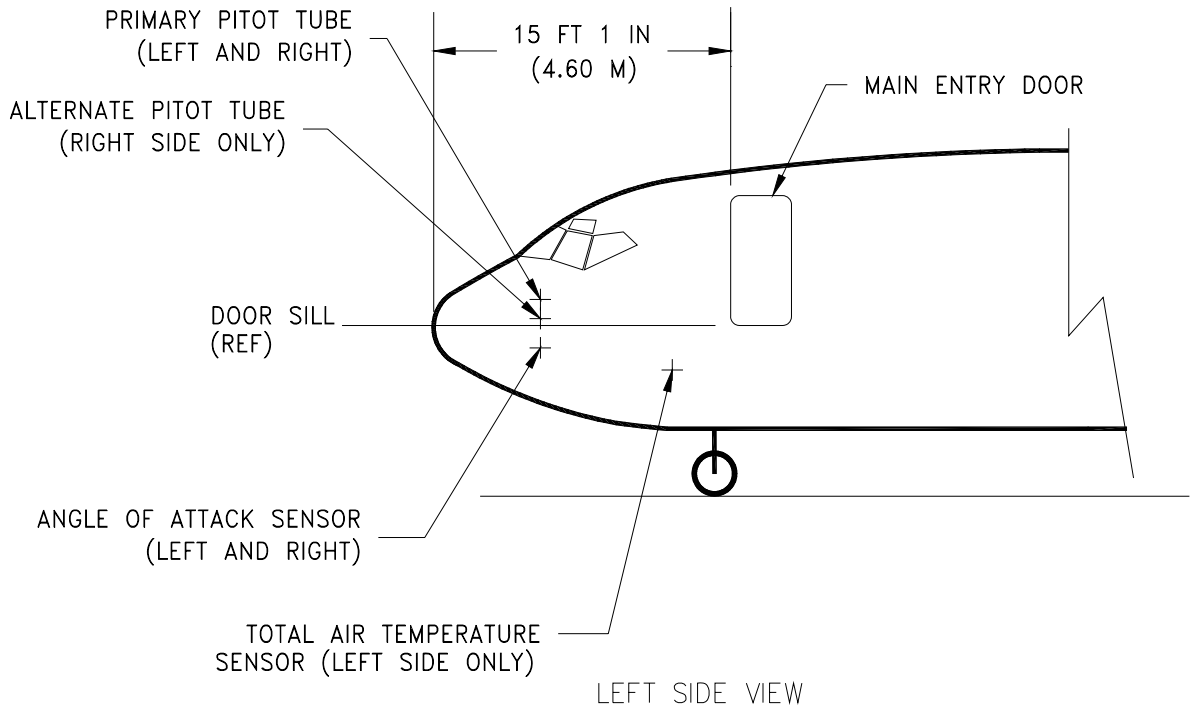

NAME OF SENSOR	DISTANCE AFT OF NOSE	DISTANCE ABOVE (+) OR BELOW (-) DOOR SILL REFERENCE LINE	PROTRUSION FROM AIRPLANE SKIN
PRIMARY PITOT-STATIC (L/R)	5 FT 3 IN (1.60 M)	+1 FT 3 IN (0.38 M)	6 IN (0.15 M)
ALTERNATE PITOT-STATIC (R)	5 FT 3 IN (1.60 M)	+ 3 IN (0.08 M)	6 IN (0.15 M)
ANGLE OF ATTACK (L/R)	5 FT 2 IN (1.57 M)	-5 IN (-0.13 M)	4 IN (0.10 M)
TOTAL AIR TEMPERATURE (L)	11 FT 6 IN (3.51 M)	+ 1 FT 6 IN (0.46 M)	4 IN (0.10 M)

2.7.3 DOOR CLEARANCES - LOCATIONS OF SENSORS AND PROBES - FORWARD OF MAIN ENTRY DOOR NO 1
MODEL 737, ALL MODELS

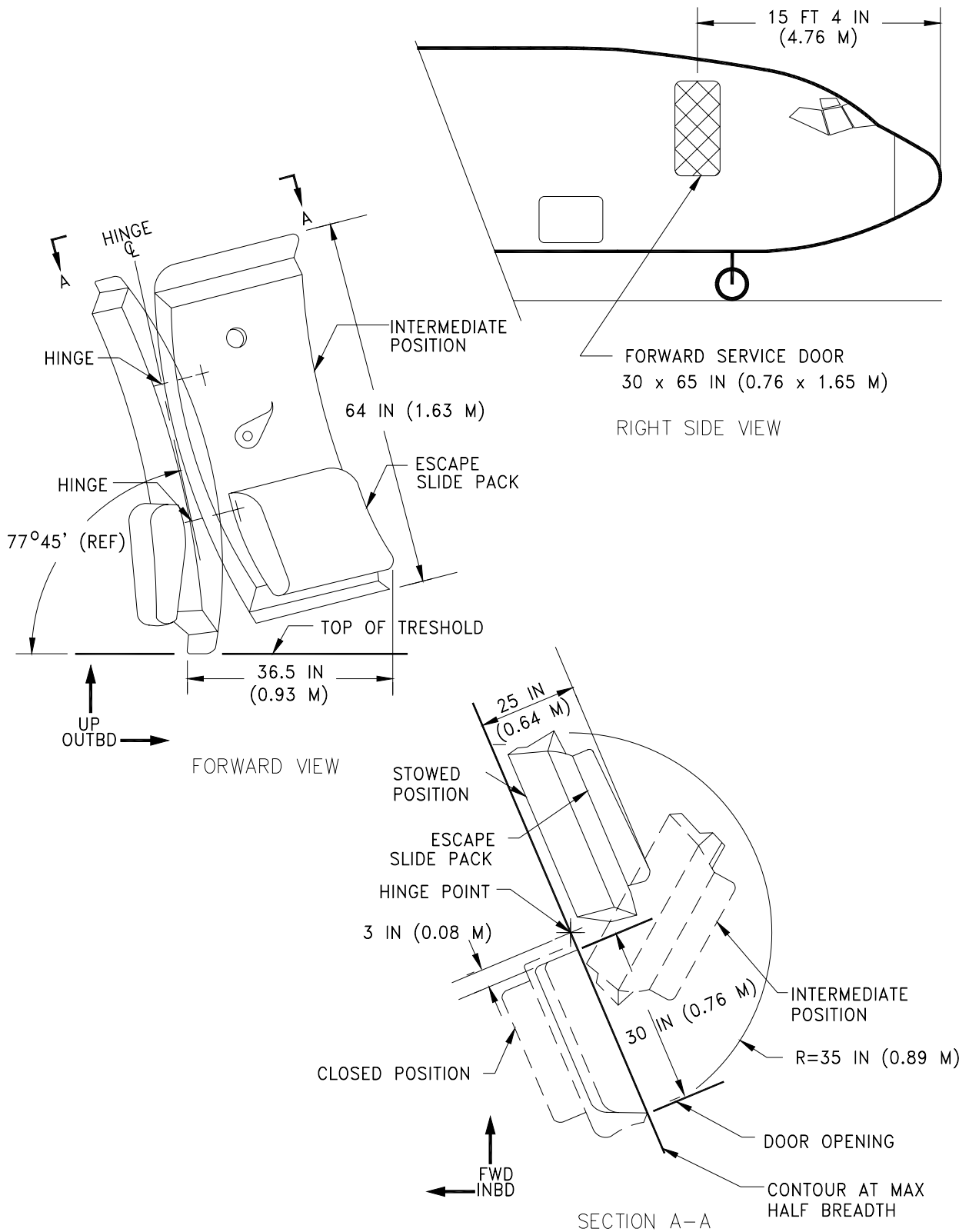

2.7.4 DOOR CLEARANCES - FORWARD SERVICE DOOR
MODEL 737, ALL MODELS

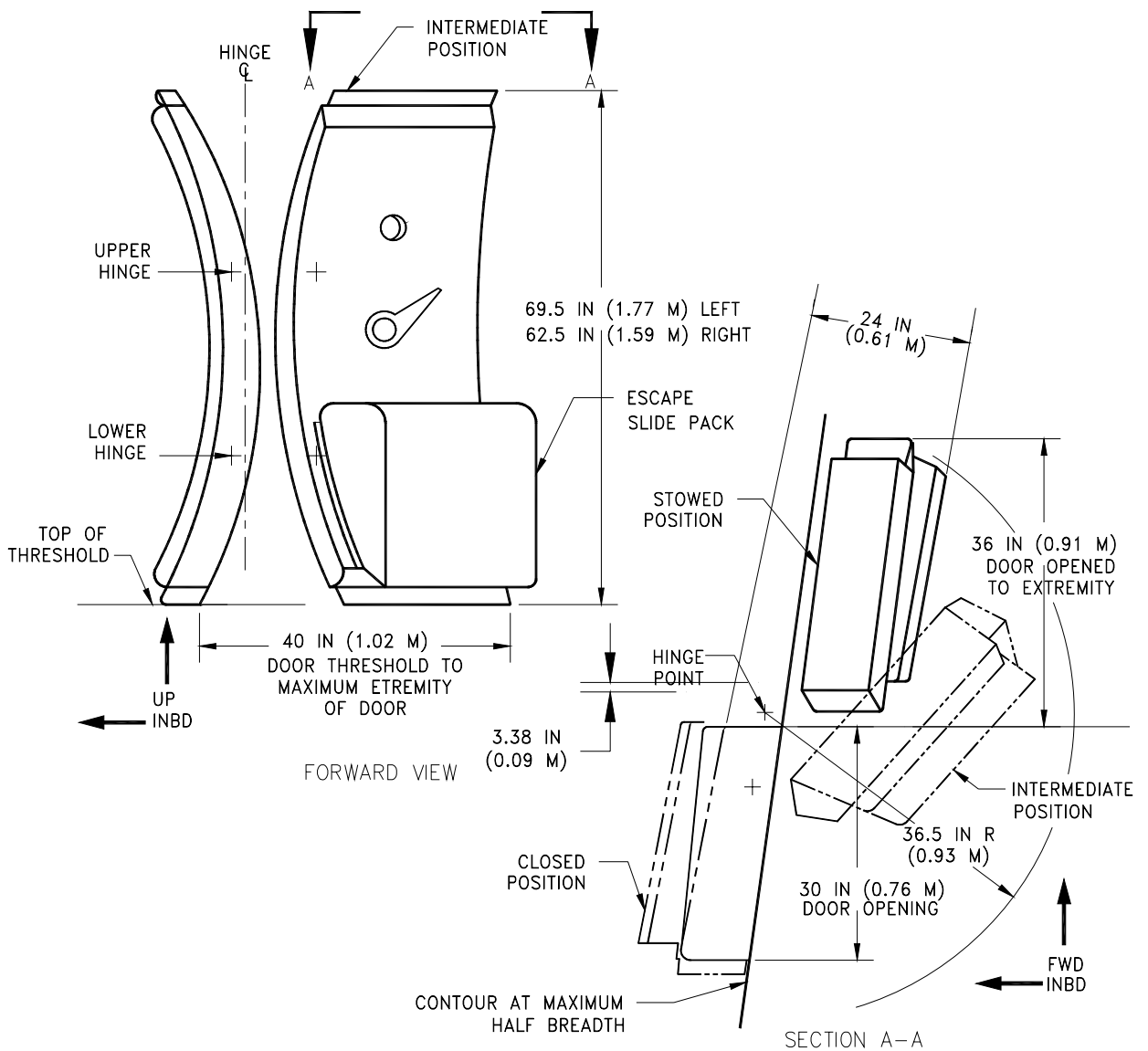
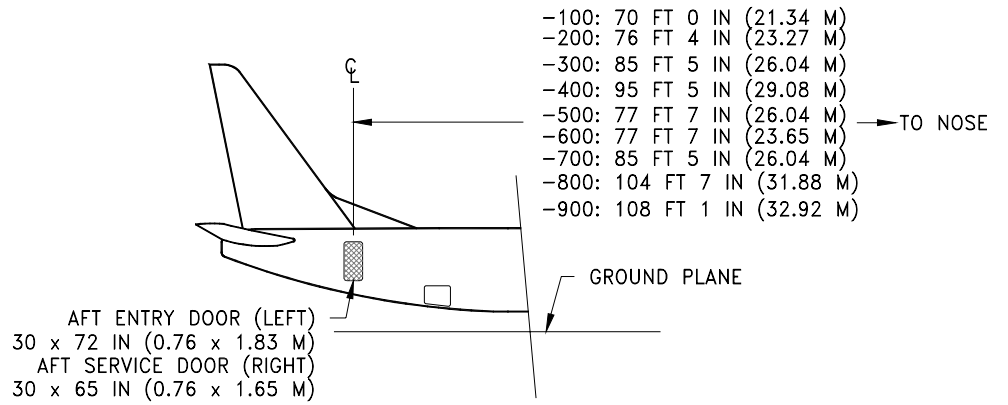

2.7.5 DOOR CLEARANCES - AFT ENTRY DOOR AND AFT SERVICE DOOR
MODEL 737, ALL MODELS

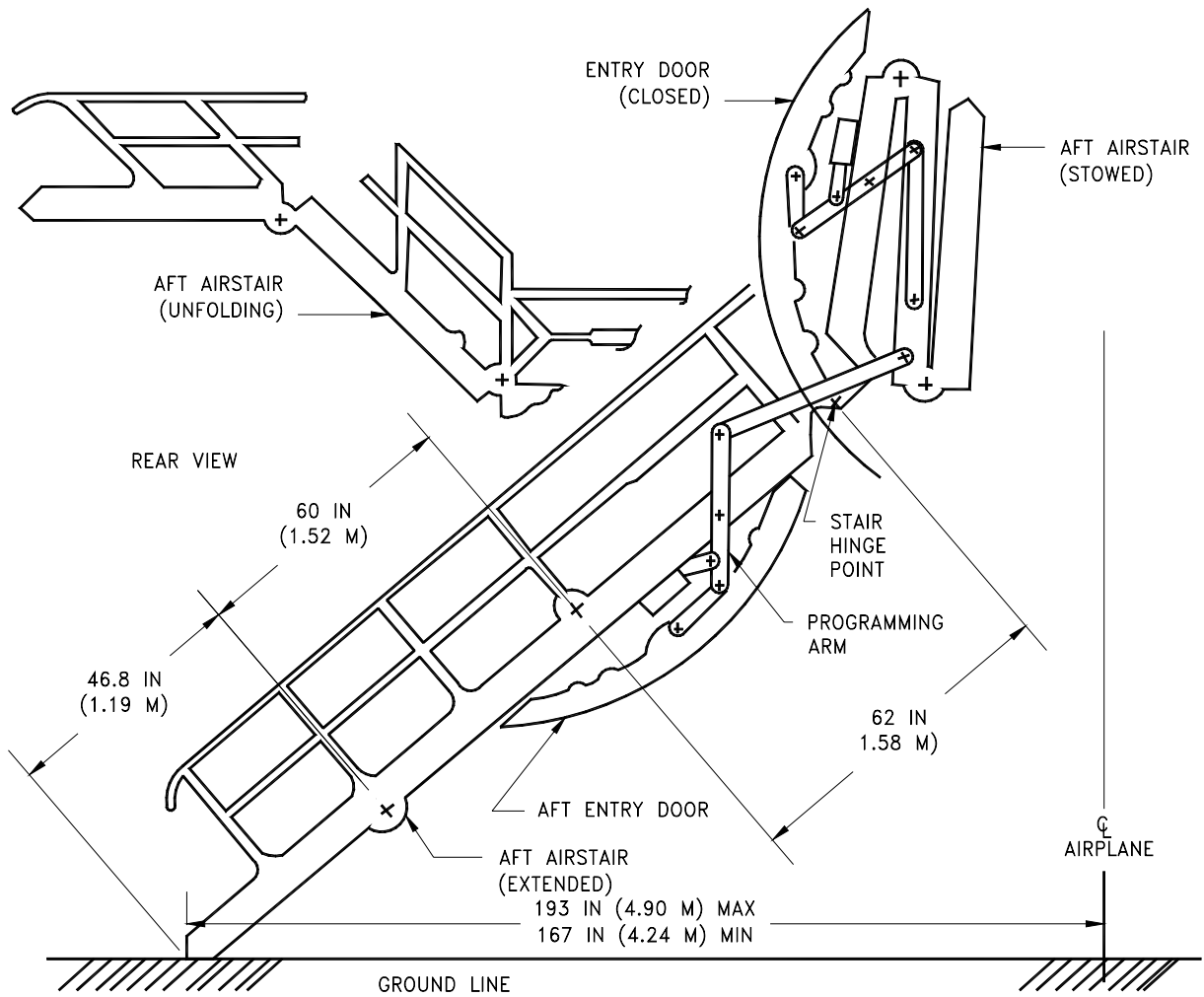
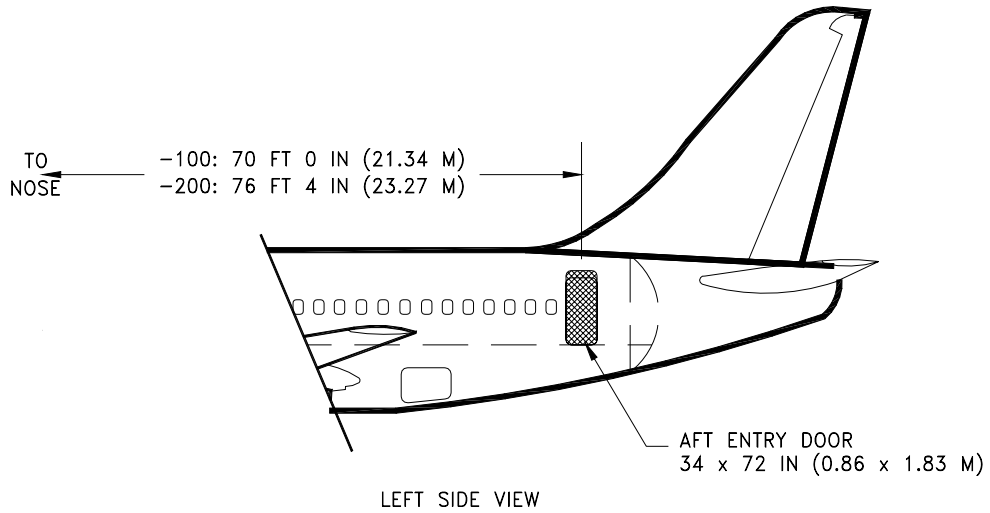

2.7.6 DOOR CLEARANCES - AFT ENTRY DOOR WITH OPTIONAL AIRSTAIR
 MODEL 737-100, 200

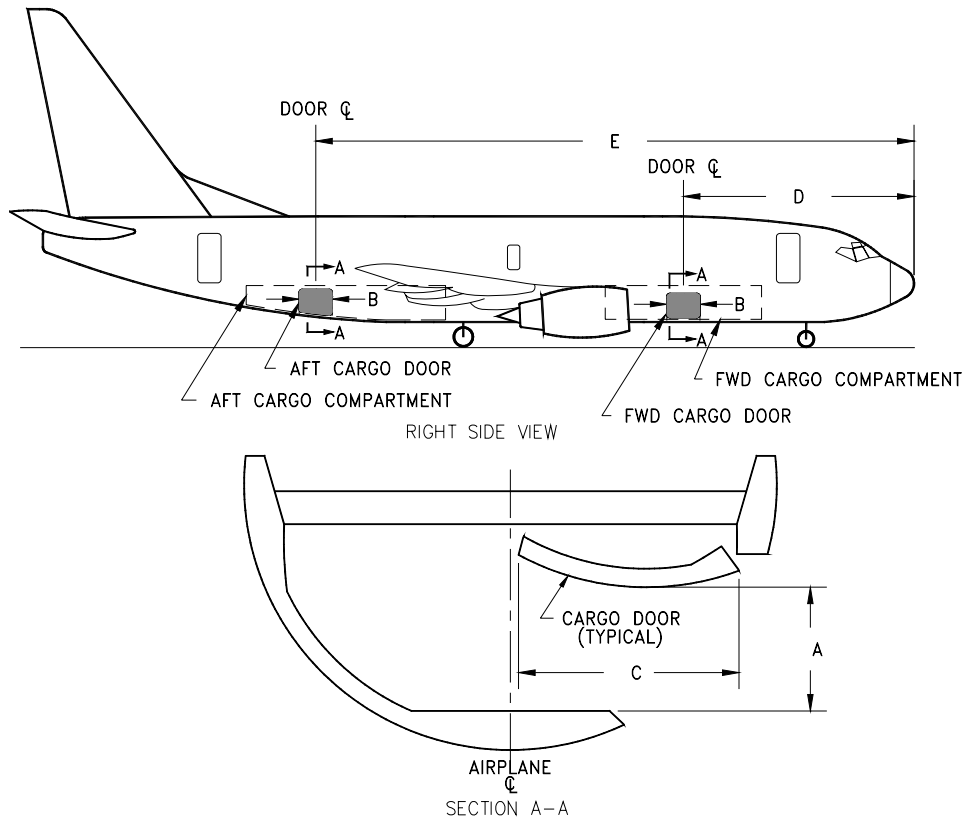

AIRPLANE MODEL	FORWARD CARGO DOOR			AFT CARGO DOOR		
	DOOR SIZE (C x B)	CLEAR OPENING (A x B)	DISTANCE FROM NOSE TO DOOR CL (D)	DOOR SIZE (C x B)	CLEAR OPENING (A x B)	DISTANCE FROM NOSE TO DOOR CL (E)
737-100	51 x 48 IN (1.30 x 1.22 M)	35 x 48 IN (0.89 x 1.22 M)	26 FT 4.5 IN (8.03 M)	48 x 48 IN (1.22 x 1.22 M)	33 x 48 IN (0.84 x 1.22 M)	60 FT 3.5 IN (18.37 M)
737-200	51 x 48 IN (1.30 x 1.22 M)	35 x 48 IN (0.89 x 1.22 M)	28 FT 0.25 IN (8.54 M)	48 x 48 IN (1.22 x 1.22 M)	33 x 48 IN (0.84 x 1.22 M)	63 FT 10.5 IN (19.47 M)
737-300	51 x 48 IN (1.30 x 1.22 M)	35 x 48 IN (0.89 x 1.22 M)	28 FT 0.25 IN (8.54 M)	48 x 48 IN (1.22 x 1.22 M)	33 x 48 IN (0.84 x 1.22 M)	72 FT 6.5 IN (22.11 M)
737-400	51 x 48 IN (1.30 x 1.22 M)	35 x 48 IN (0.89 x 1.22 M)	28 FT 0.25 IN (8.54 M)	48 x 48 IN (1.22 x 1.22 M)	33 x 48 IN (0.84 x 1.22 M)	82 FT 6.5 IN (25.16 M)
737-500	51 x 48 IN (1.30 x 1.22 M)	35 x 48 IN (0.89 x 1.22 M)	24 FT 8.25 IN (7.52 M)	48 x 48 IN (1.22 x 1.22 M)	33 x 48 IN (0.84 x 1.22 M)	64 FT 8.5 IN (19.72 M)
737-600	51 x 48 IN (1.30 x 1.22 M)	35 x 48 IN (0.89 x 1.22 M)	24 FT 8.25 IN (7.52 M)	48 x 48 IN (1.22 x 1.22 M)	33 x 48 IN (0.84 x 1.22 M)	64 FT 8.5 IN (19.72 M)
737-700 737 BBJ	51 x 48 IN (1.30 x 1.22 M)	35 x 48 IN (0.89 x 1.22 M)	28 FT 0.25 IN (8.54 M)	48 x 48 IN (1.22 x 1.22 M)	33 x 48 IN (0.84 x 1.22 M)	72 FT 6.5 IN (22.11 M)
737-800 737 BBJ2	51 x 48 IN (1.30 x 1.22 M)	35 x 48 IN (0.89 x 1.22 M)	28 FT 0.25 IN (8.54 M)	48 x 48 IN (1.22 x 1.22 M)	33 x 48 IN (0.84 x 1.22 M)	91 FT 8.5 IN (27.95 M)
737-900	51 x 48 IN (1.30 x 1.22 M)	35 x 48 IN (0.89 x 1.22 M)	28 FT 0.25 IN (8.54 M)	48 x 48 IN (1.22 x 1.22 M)	33 x 48 IN (0.84 x 1.22 M)	100 FT 4.5 IN (30.59 M)

2.7.7 DOOR CLEARANCES - LOWER DECK CARGO COMPARTMENTS

MODEL 737-600, -700, -800, -900, BBJ1, BBJ2

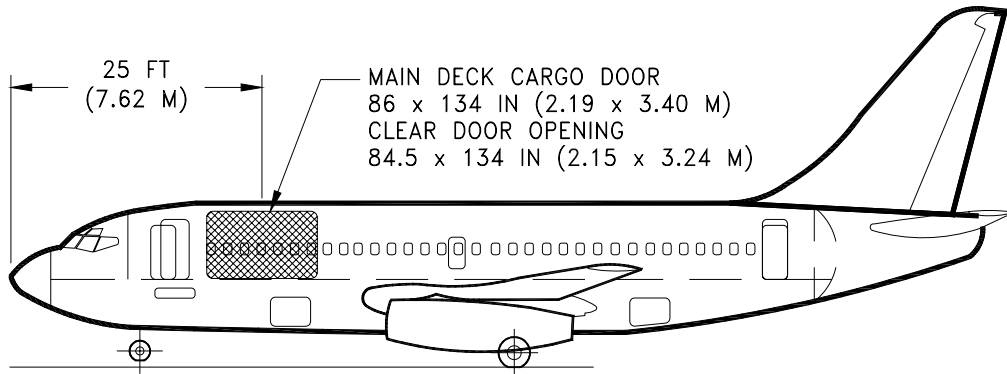

LEFT SIDE VIEW

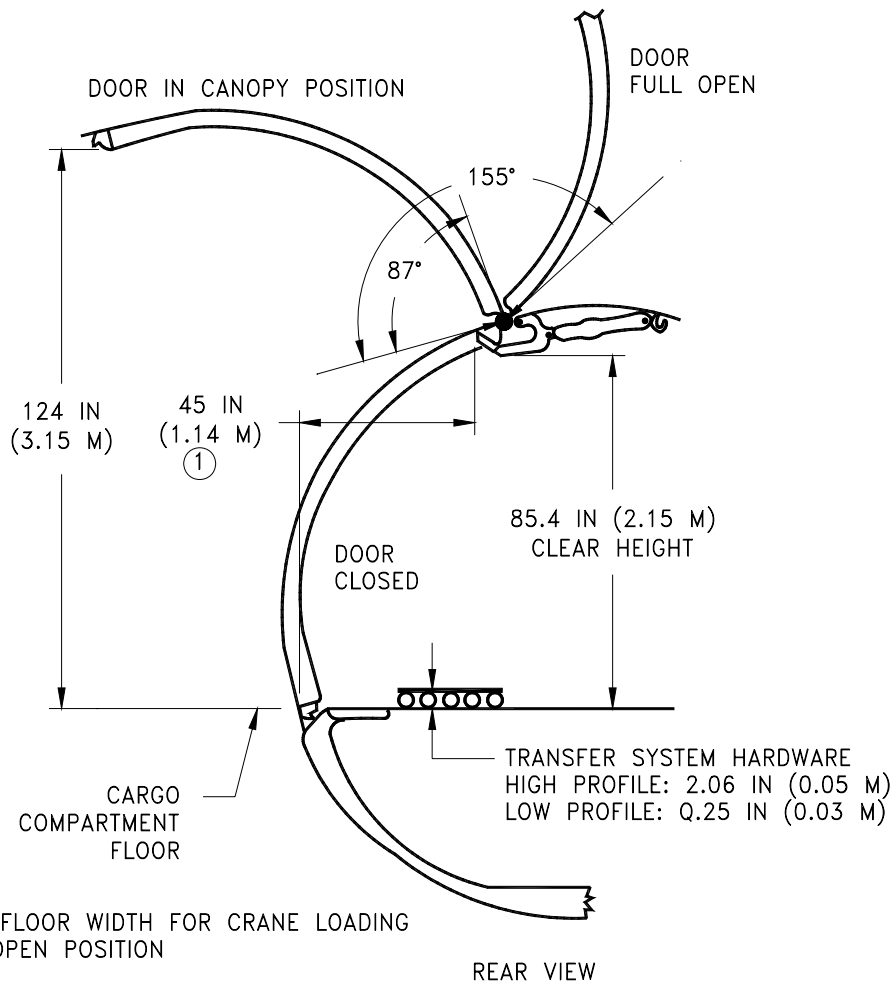

NOTE:
 ① EXPOSED FLOOR WIDTH FOR CRANE LOADING
 IN FULL OPEN POSITION

REAR VIEW

2.7.8 DOOR CLEARANCES – MAIN DECK CARGO DOOR
 MODEL 737-200C

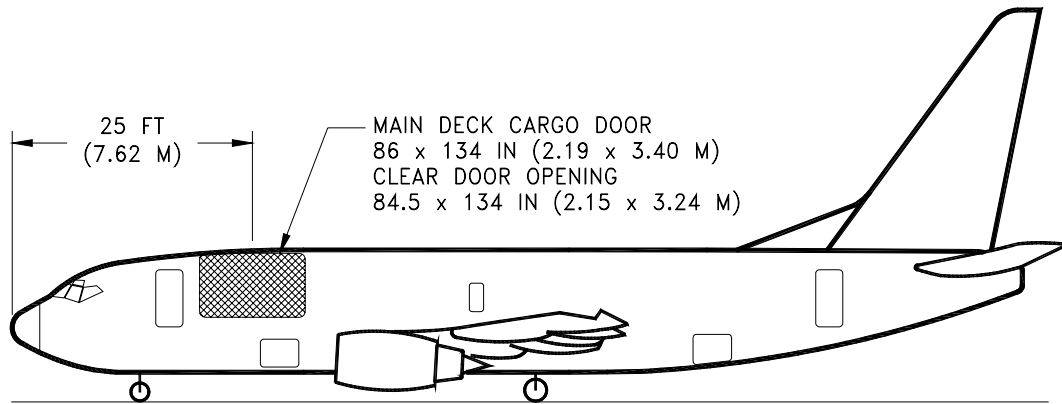

LEFT SIDE VIEW

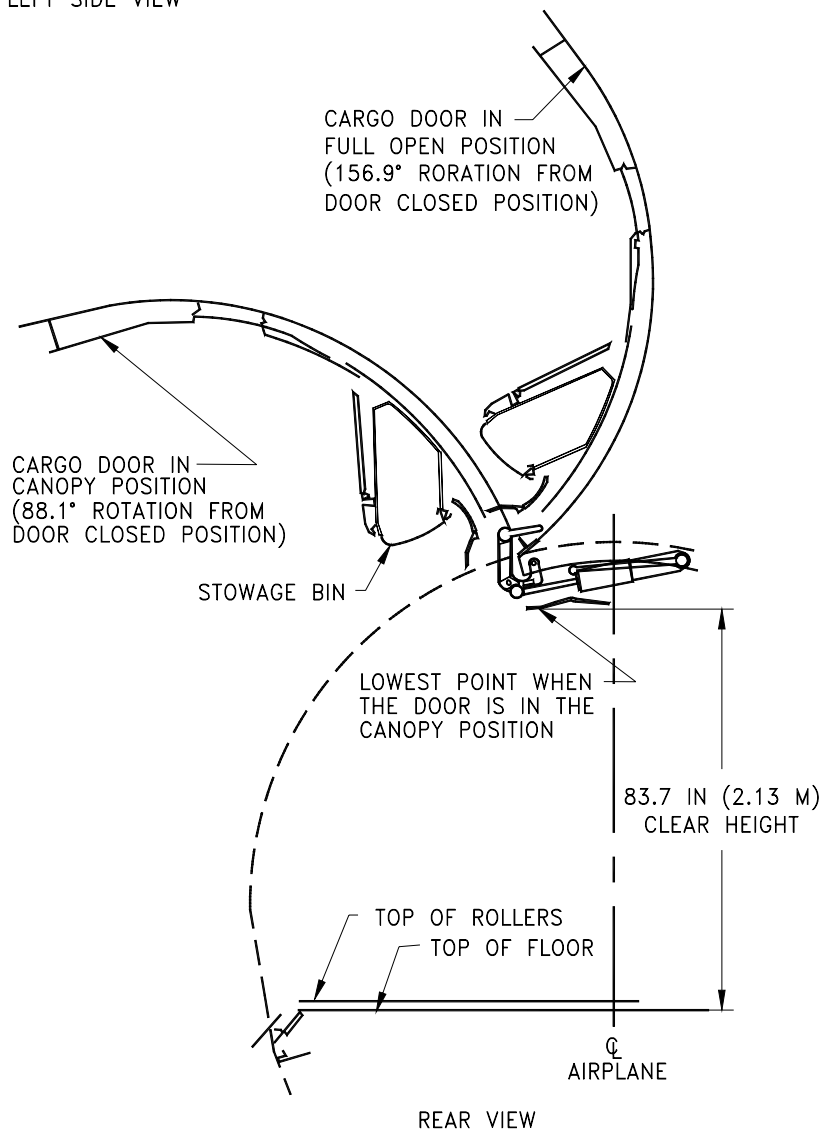

2.7.9 DOOR CLEARANCES – MAIN DECK CARGO DOOR
MODEL 737-700C

THIS PAGE INTENTIONALLY LEFT BLANK

3.0 AIRPLANE PERFORMANCE

3.1 General Information

3.2 Payload/Range for Long Range Cruise

3.3 F.A.R. and J.A.R. Takeoff Runway Length Requirements

3.4 F.A.R. Landing Runway Length Requirements

3.0 AIRPLANE PERFORMANCE

3.1 General Information

The graphs in Section 3.2 provide information on operational empty weight (OEW) and payload, trip range, brake release gross weight, and fuel limits for airplane models with the different engine options. To use these graphs, if the trip range and zero fuel weight (OEW + payload) are known, the approximate brake release weight can be found, limited by fuel quantity.

The graphs in Section 3.3 provide information on F.A.R. takeoff runway length requirements with the different engines at different pressure altitudes. Maximum takeoff weights shown on the graphs are the heaviest for the particular airplane models with the corresponding engines. Standard day temperatures for pressure altitudes shown on the F.A.R. takeoff graphs are given below:

PRESSURE ALTITUDE		STANDARD DAY TEMP	
FEET	METERS	°F	°C
0	0	59.0	15.00
2,000	610	51.9	11.04
4,000	1,219	44.7	7.06
6,000	1,829	37.6	3.11
8,000	2,438	30.5	-0.85

For airplanes which are governed by the European Joint Airworthiness Authorities (JAA), the wet runway performance is shown in accordance with JAR-OPS 1 Subpart F, with wet runways defined in Paragraph 1.480(a)(10). Skid-resistant runways (grooved or PFC treated) per FAA or ICAO specifications exhibit runway length requirements that remove some or all of the length penalties associated with smooth (non-grooved) runways. Under predominantly wet conditions, the wet runway performance characteristics may be used to determine runway length requirements, if it is longer than the dry runway performance requirements.

The graphs in Section 3.4 provide information on landing runway length requirements for different airplane weights and airport altitudes. The maximum landing weights shown are the heaviest for the particular airplane model.

NOTES:

- * DOMESTIC RESERVES
- * JT9D-7 ENGINES
- * STANDARD DAY, ZERO WIND
- * LRC AT 30,000 FEET (9,150 METERS)
- * CONSULT WITH USING AIRLINE FOR SPECIFIC OPERATING PROCEDURE PRIOR TO FACILITY DESIGN

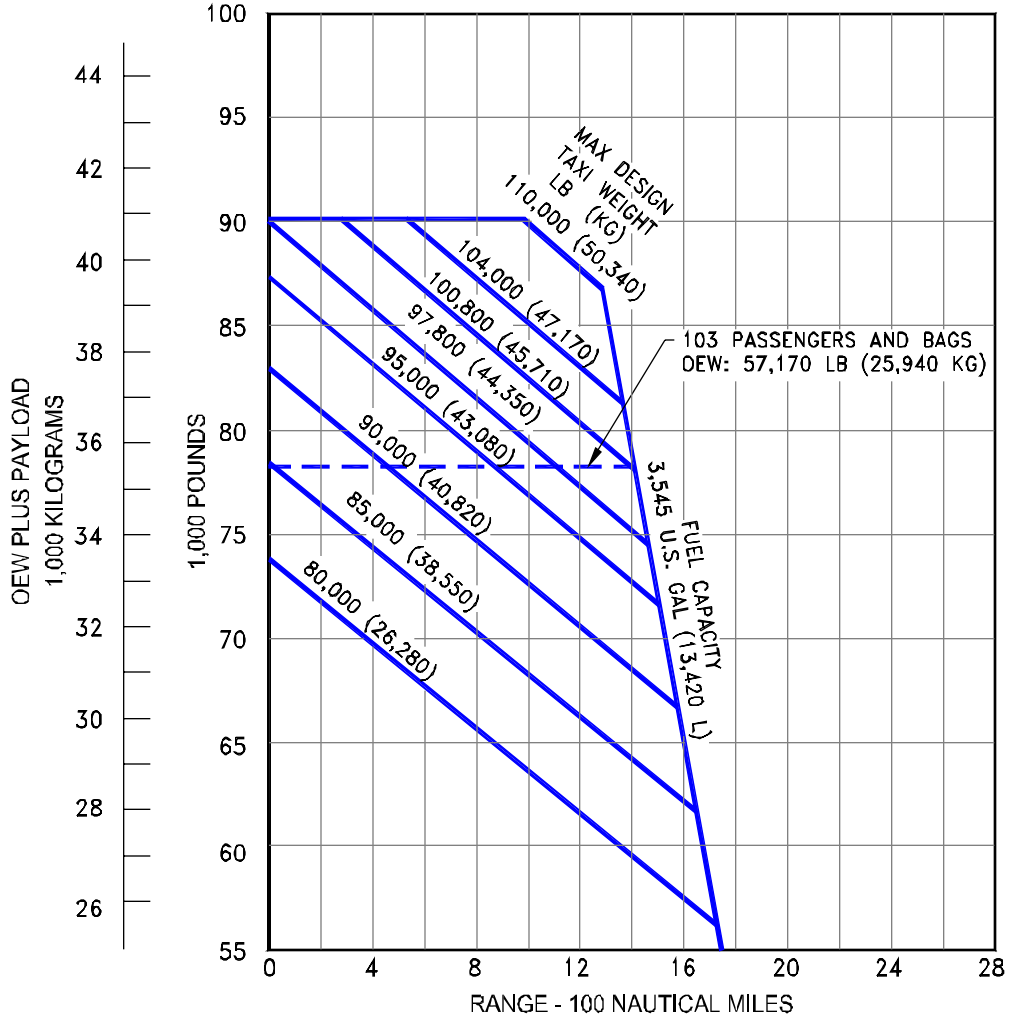

* FOR TAKEOFF WEIGHT, SUBTRACT 500 LB (227 KG) FROM TAXI WEIGHT

3.2.1 PAYLOAD/RANGE FOR LONG-RANGE CRUISE
 MODEL 737-100 (JT8D-7 ENGINES)

NOTES:

- * DOMESTIC RESERVES
- * JT9D-9/9A ENGINES
- * STANDARD DAY, ZERO WIND
- * LRC AT 30,000 FEET (9,150 METERS)
- * CONSULT WITH USING AIRLINE FOR SPECIFIC OPERATING PROCEDURE PRIOR TO FACILITY DESIGN

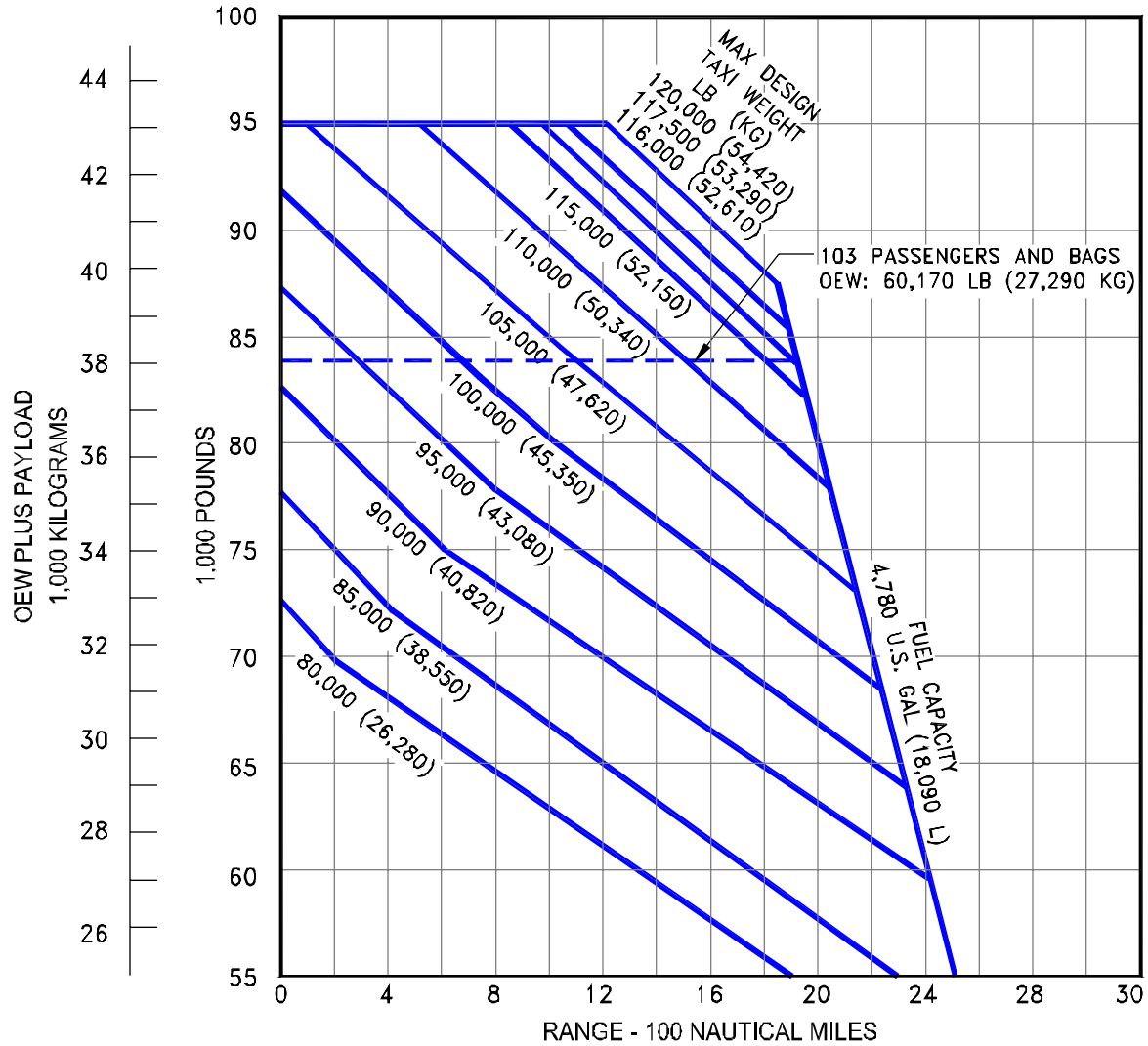

* FOR TAKEOFF WEIGHT, SUBTRACT 500 LB (227 KG) FROM TAXI WEIGHT

3.2.2 PAYLOAD/RANGE FOR LONG-RANGE CRUISE
 MODEL 737-200 (JT8D-9/9A ENGINES)

NOTES:

- * DOMESTIC RESERVES
- * JT9D-15/15A ENGINES
- * STANDARD DAY, ZERO WIND
- * LRC AT 30,000 FEET (9,150 METERS)
- * CONSULT WITH USING AIRLINE FOR SPECIFIC OPERATING PROCEDURE PRIOR TO FACILITY DESIGN

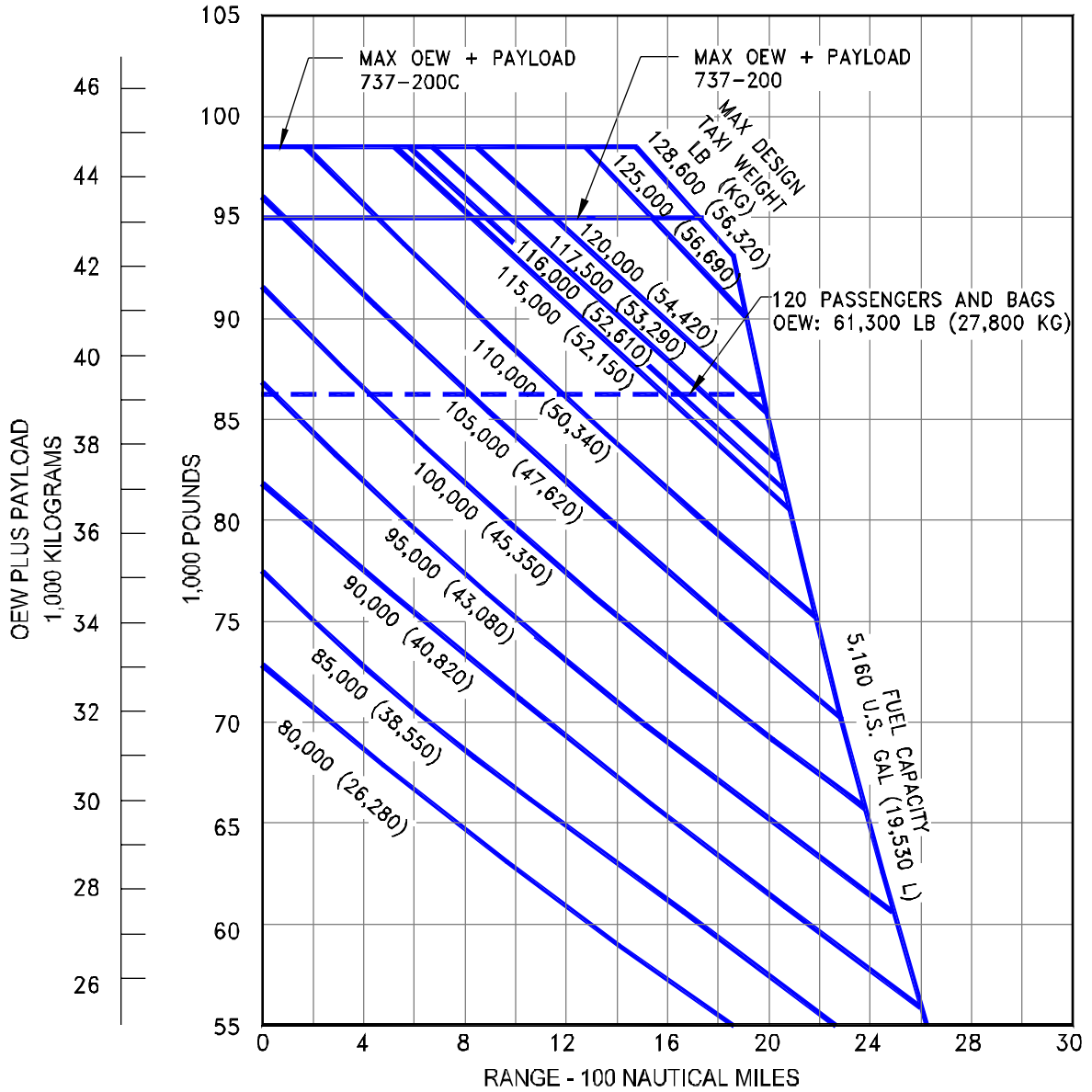

* FOR TAKEOFF WEIGHT, SUBTRACT 500 LB (227 KG) FROM TAXI WEIGHT

3.2.3 PAYLOAD/RANGE FOR LONG-RANGE CRUISE
 MODEL ADVANCED 737-200 (JT8D-15/15A ENGINES)

NOTES:

- * DOMESTIC RESERVES
- * JT9D-17/17A ENGINES
- * STANDARD DAY, ZERO WIND
- * LRC AT 30,000 FEET (9,150 METERS)
- * CONSULT WITH USING AIRLINE FOR SPECIFIC OPERATING PROCEDURE PRIOR TO FACILITY DESIGN

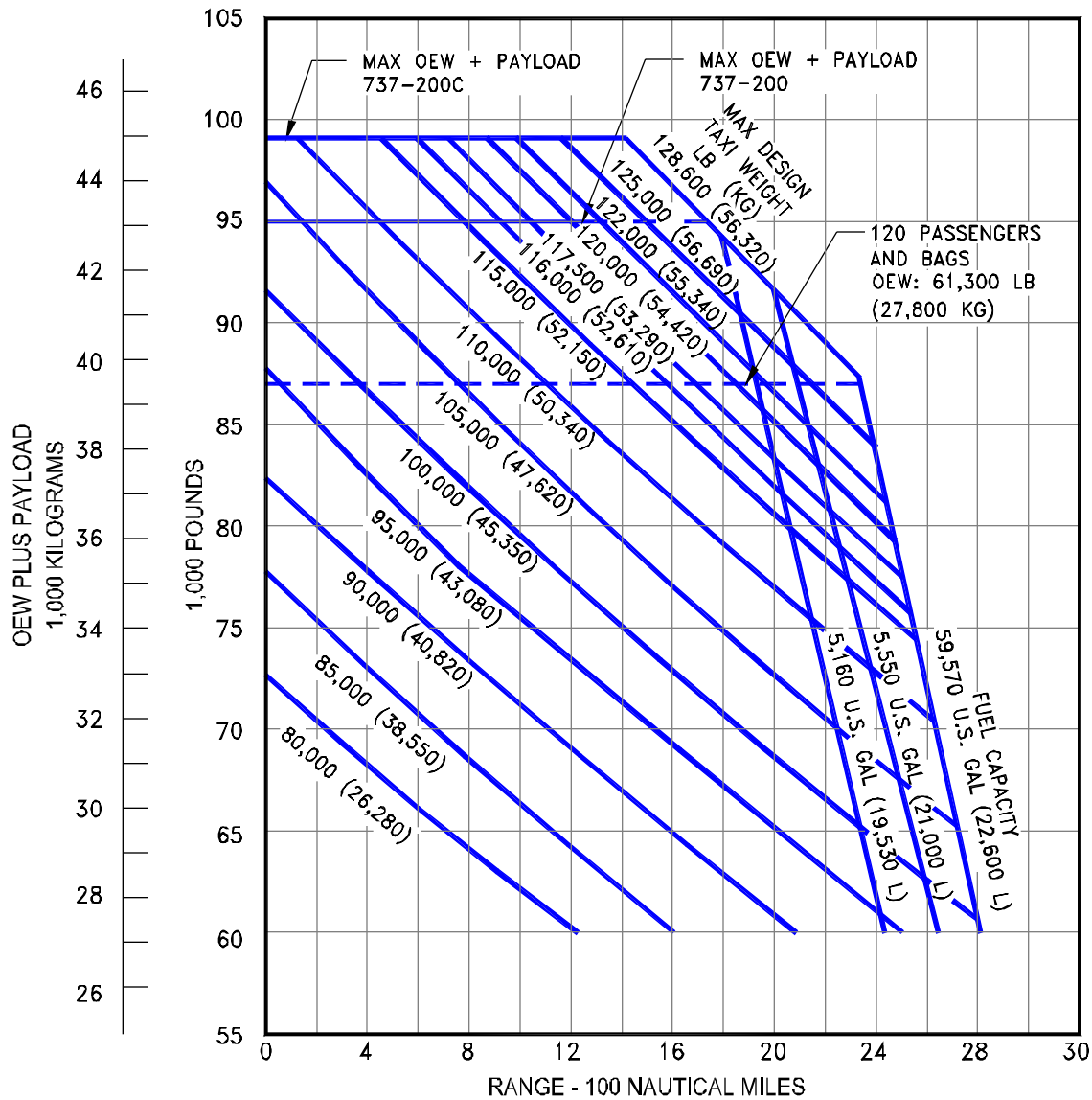

* FOR TAKEOFF WEIGHT, SUBTRACT 500 LB (227 KG) FROM TAXI WEIGHT

3.2.4 PAYLOAD/RANGE FOR LONG-RANGE CRUISE
 MODEL ADVANCED 737-200 (JT8D-17/17A ENGINES)

NOTES:

- * DOMESTIC RESERVES
- * JT9D-17R/17AR ENGINES
- * STANDARD DAY, ZERO WIND
- * LRC AT 30,000 FEET (9,150 METERS)
- * CONSULT WITH USING AIRLINE FOR SPECIFIC OPERATING PROCEDURE PRIOR TO FACILITY DESIGN

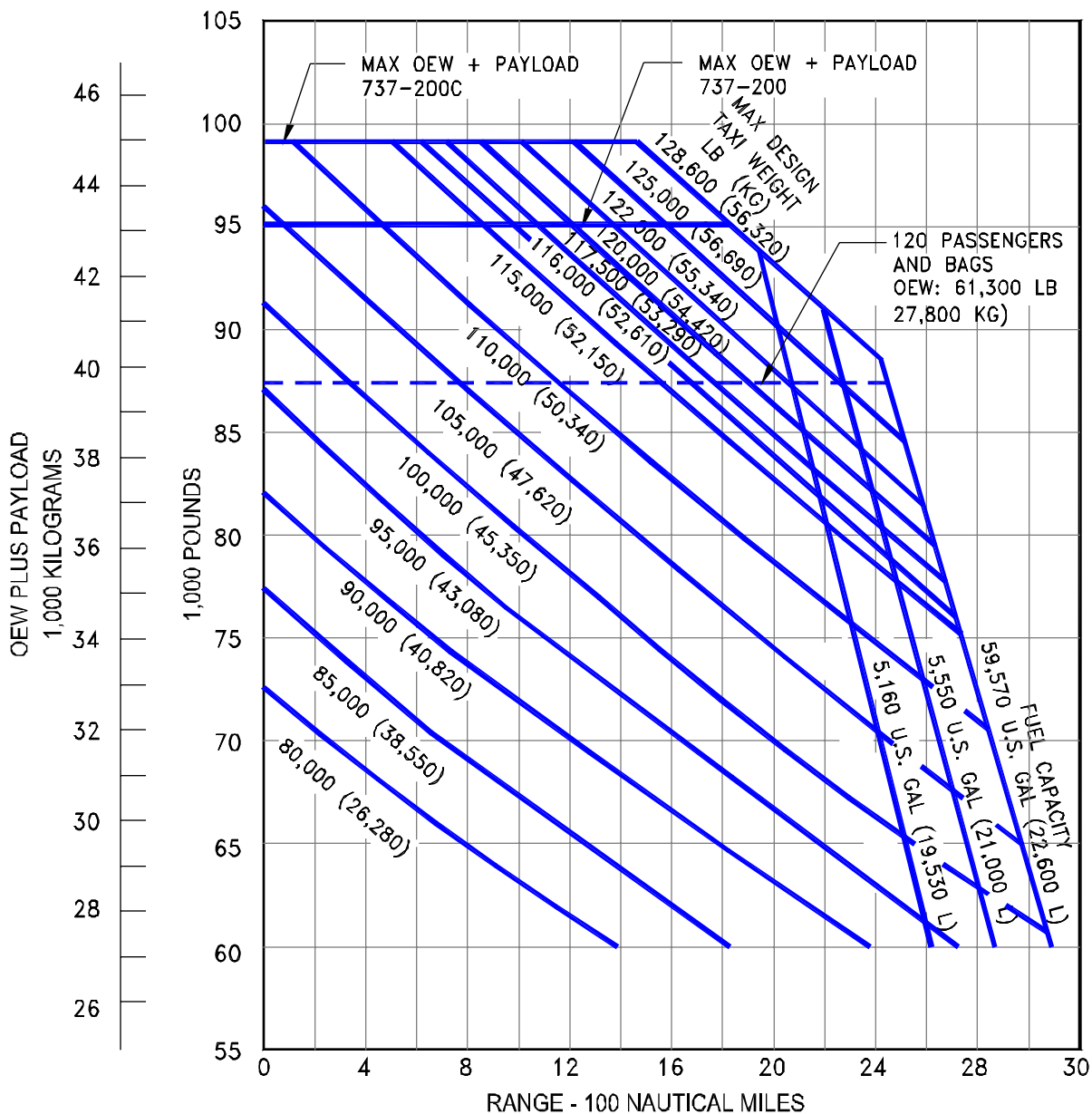

* FOR TAKEOFF WEIGHT, SUBTRACT 500 LB (227 KG) FROM TAXI WEIGHT

3.2.5 PAYLOAD/RANGE FOR LONG-RANGE CRUISE
 MODEL ADVANCED 737-200 (JT8D-17R/17AR ENGINES)

NOTES:

- * DOMESTIC RESERVES
- * CFM56-3B-1 OR CFM56-3B-2 ENGINES
- * STANDARD DAY, ZERO WIND
- * LRC AT 31,000/35,000 FEET
- * CONSULT USING AIRLINE FOR SPECIFIC OPERATING PROCEDURE PRIOR TO FACILITY DESIGN

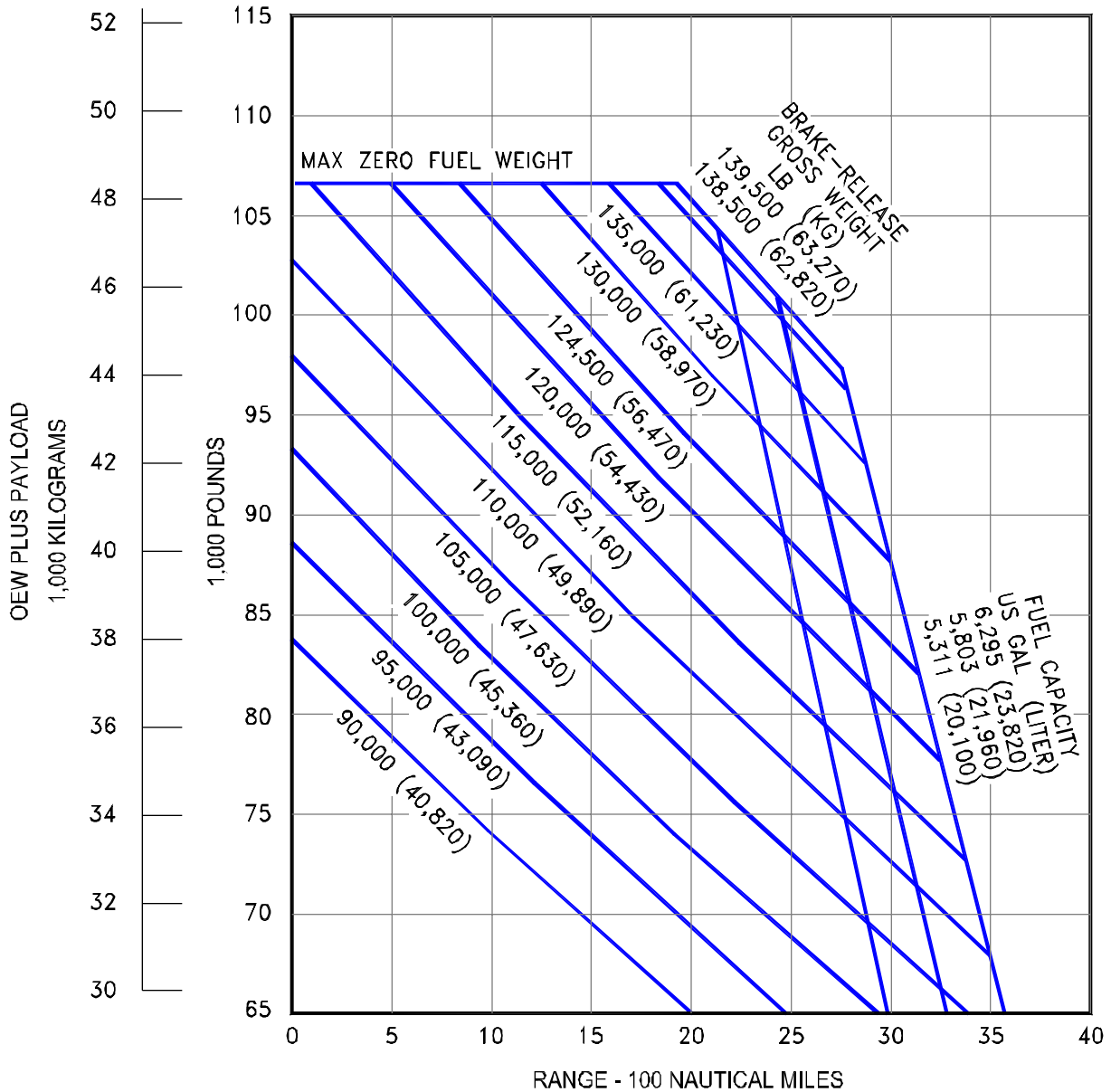

3.2.6 PAYLOAD/RANGE FOR LONG-RANGE CRUISE
 MODEL 737-300

NOTES:

- * DOMESTIC RESERVES
- * CFM56-3B-2 OR CFM56-3C-1 ENGINES
- * STANDARD DAY, ZERO WIND
- * LRC AT 31,000/35,000 FEET
- * CONSULT USING AIRLINE FOR SPECIFIC OPERATING PROCEDURE PRIOR TO FACILITY DESIGN

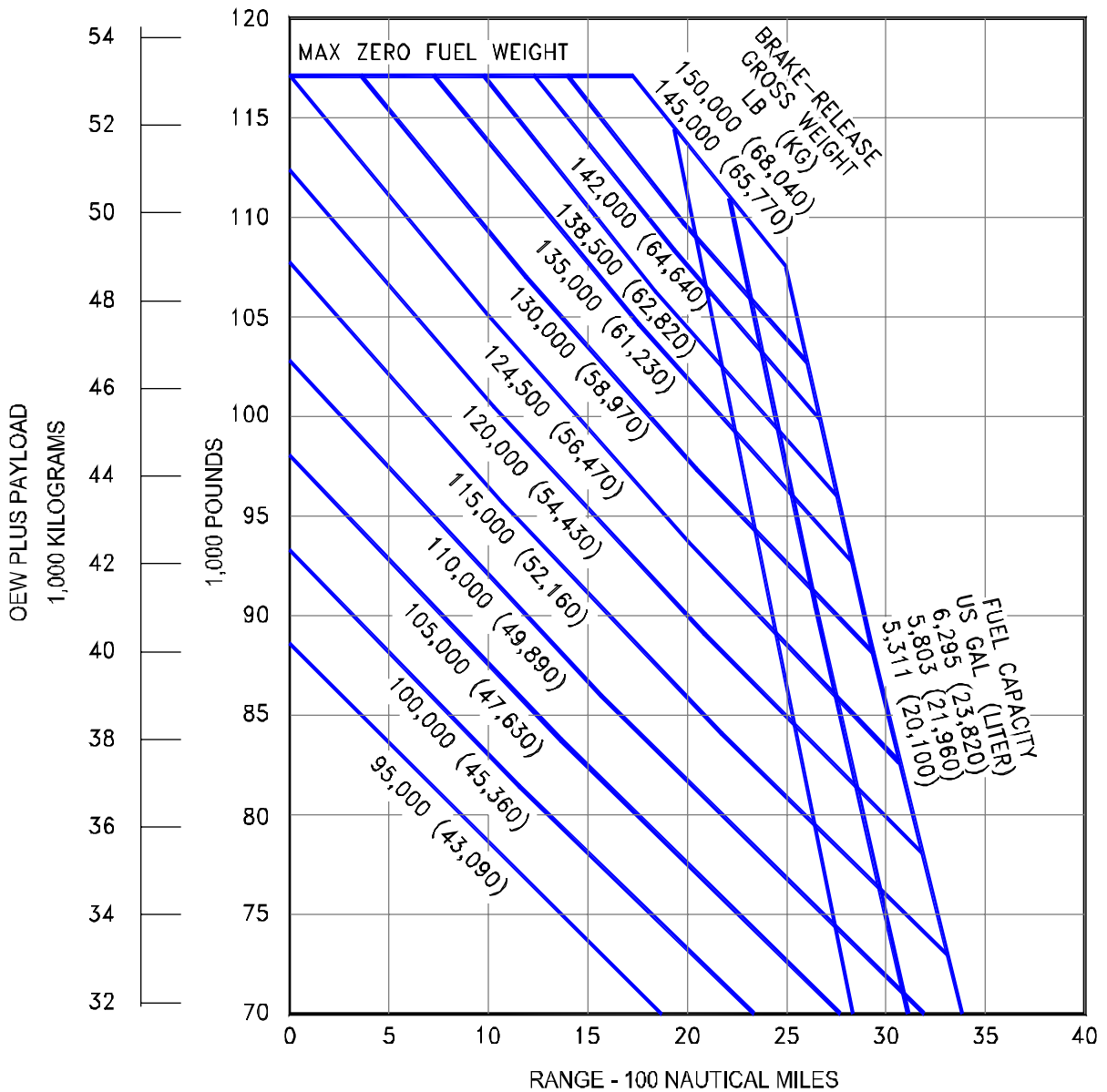

3.2.7 PAYLOAD/RANGE FOR LONG-RANGE CRUISE
 MODEL 737-400

NOTES:

- * DOMESTIC RESERVES
- * CFM56-3B-1 ENGINES
- * STANDARD DAY, ZERO WIND
- * LRC AT 31,000/35,000 FEET
- * CONSULT USING AIRLINE FOR SPECIFIC OPERATING PROCEDURE PRIOR TO FACILITY DESIGN

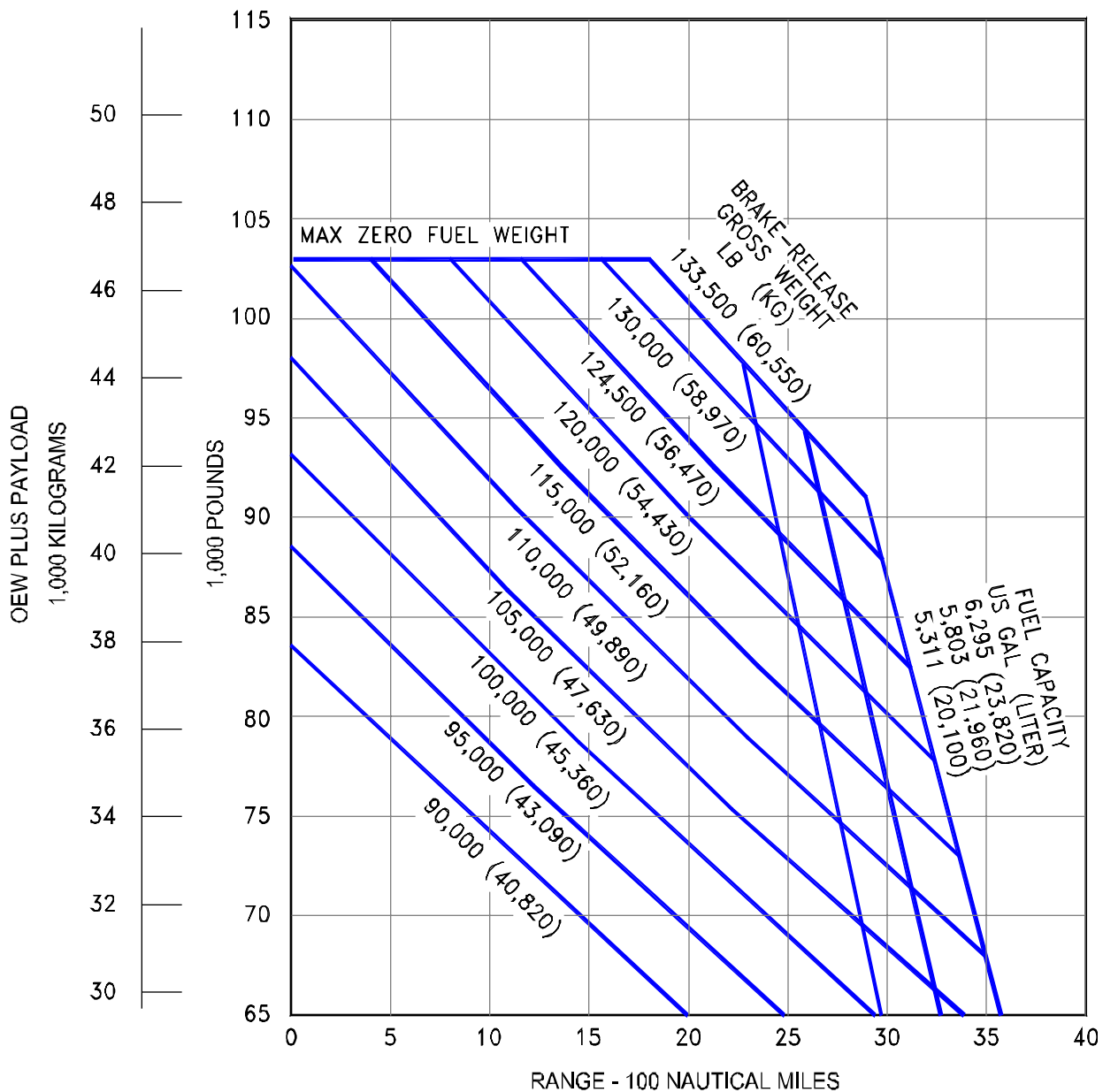

3.2.8 PAYLOAD/RANGE FOR LONG-RANGE CRUISE
 MODEL 737-500

- NOTES:
- 31-35-39,000 FT STEP CRUISE
 - CRUISE MACH = LRC
 - STANDARD DAY
 - 200 NMI ALTERNATIVE
 - TYPICAL MISSION RESERVES
 - NOMINAL PERFORMANCE
 - CONSULT WITH USING AIRLINE FOR SPECIFIC OPERATING PROCEDURE PRIOR TO FACILITY DESIGN

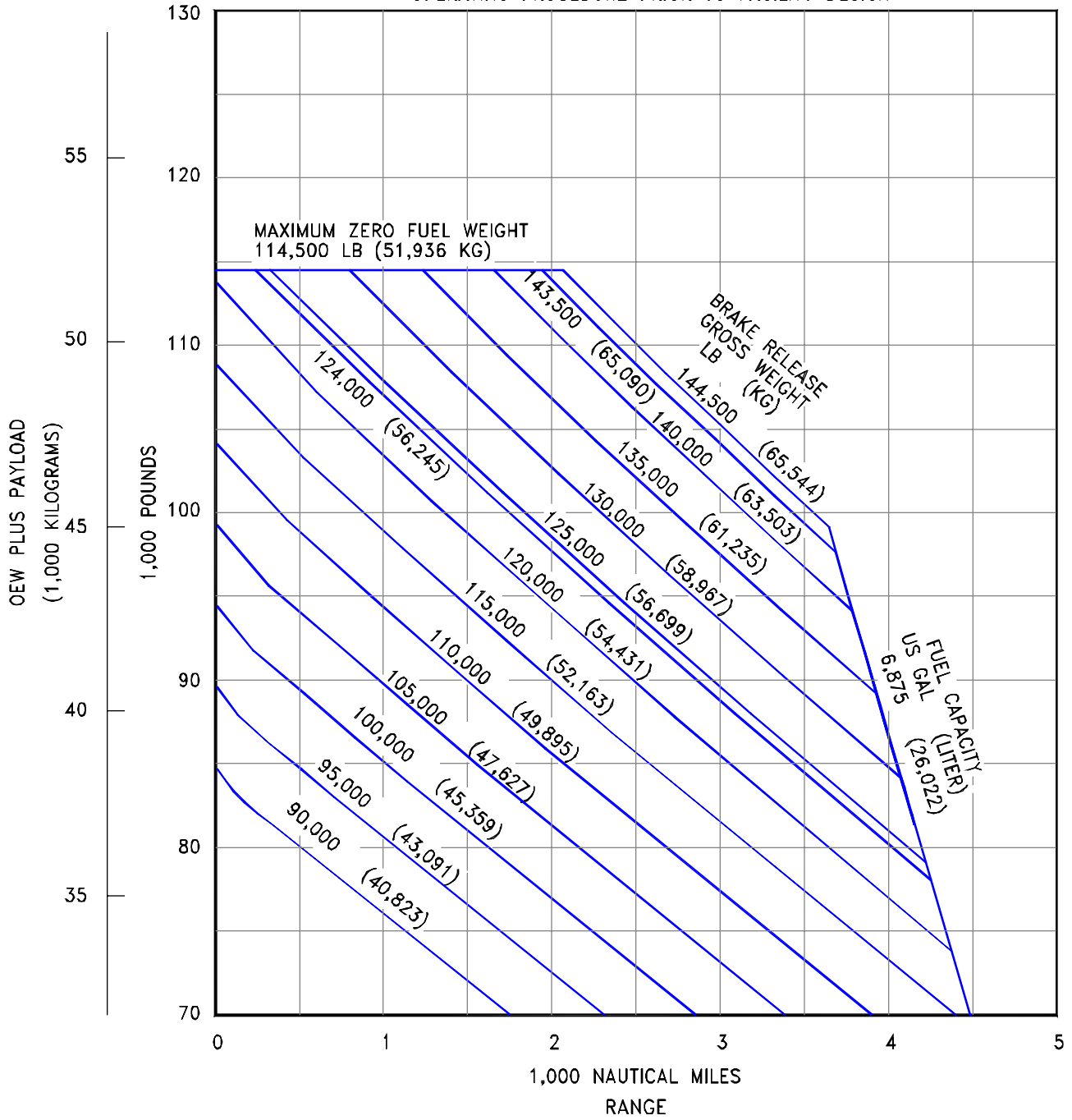

3.2.9 PAYLOAD/RANGE FOR LONG-RANGE CRUISE
 MODEL 737-600

NOTES:

- CFM56-7B ENGINES
- 31-35-39,000 FT STEP CRUISE
- CRUISE MACH = LRC
- STANDARD DAY, ZERO WIND
- 200 NMI ALTERNATE
- TYPICAL MISSION RESERVES
- NOMINAL PERFORMANCE
- CONSULT WITH USING AIRLINE FOR SPECIFIC OPERATING PROCEDURE PRIOR TO FACILITY DESIGN

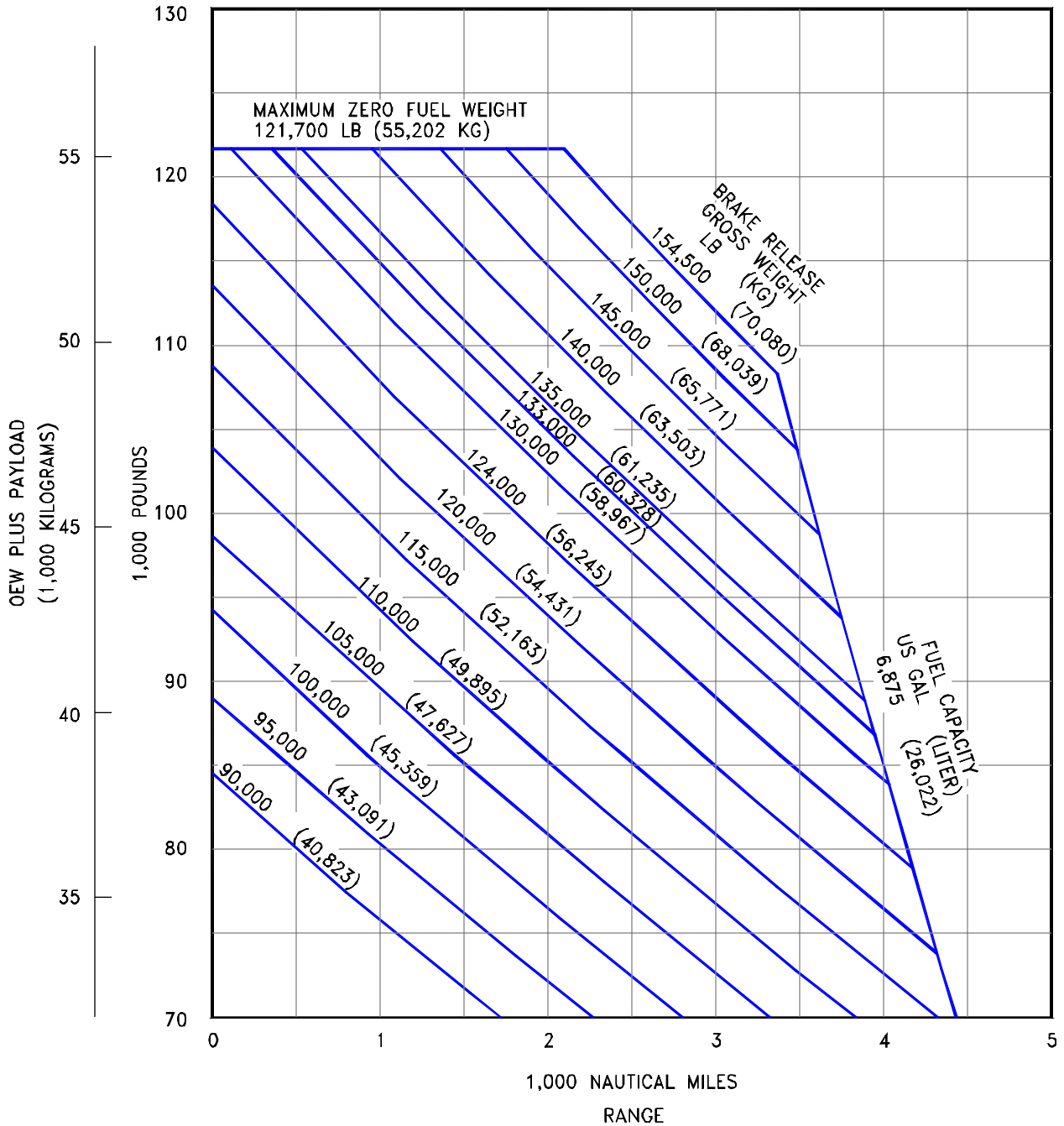

3.2.10 PAYLOAD/RANGE FOR LONG-RANGE CRUISE
 MODEL 737-700

NOTES:

- 31-35-39,000 FT STEP CRUISE
- CRUISE MACH = LRC
- STANDARD DAY, ZERO WIND
- 200 NMI ALTERNATIVE
- TYPICAL MISSION RESERVES
- NOMINAL PERFORMANCE
- CONSULT WITH USING AIRLINE FOR SPECIFIC OPERATING PROCEDURE PRIOR TO FACILITY DESIGN

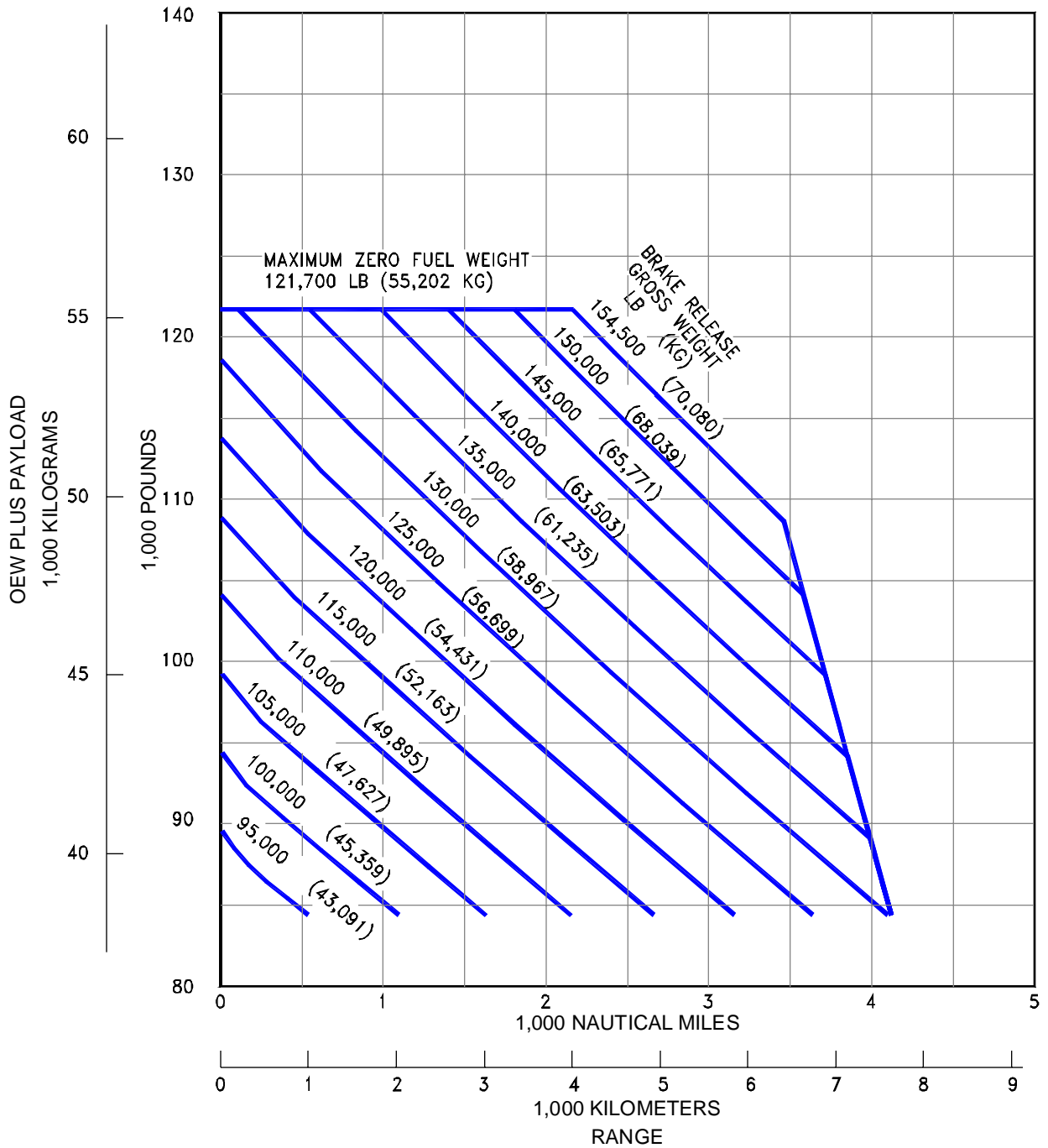

3.2.11 PAYLOAD/RANGE FOR LONG-RANGE CRUISE
 MODEL 737-700 WITH WINGLETS

- NOTES:
- NBAA MISSION RULES
 - LONG RANGE CRUISE SPEED
 - 2 A/C PACK OPERATION
 - CFM56-7B27 ENGINES
 - NOMINAL PERFORMANCE
 - CONSULT WITH USING AIRCRAFT USER FOR SPECIFIC OPERATING PROCEDURE PRIOR TO FACILITY DESIGN

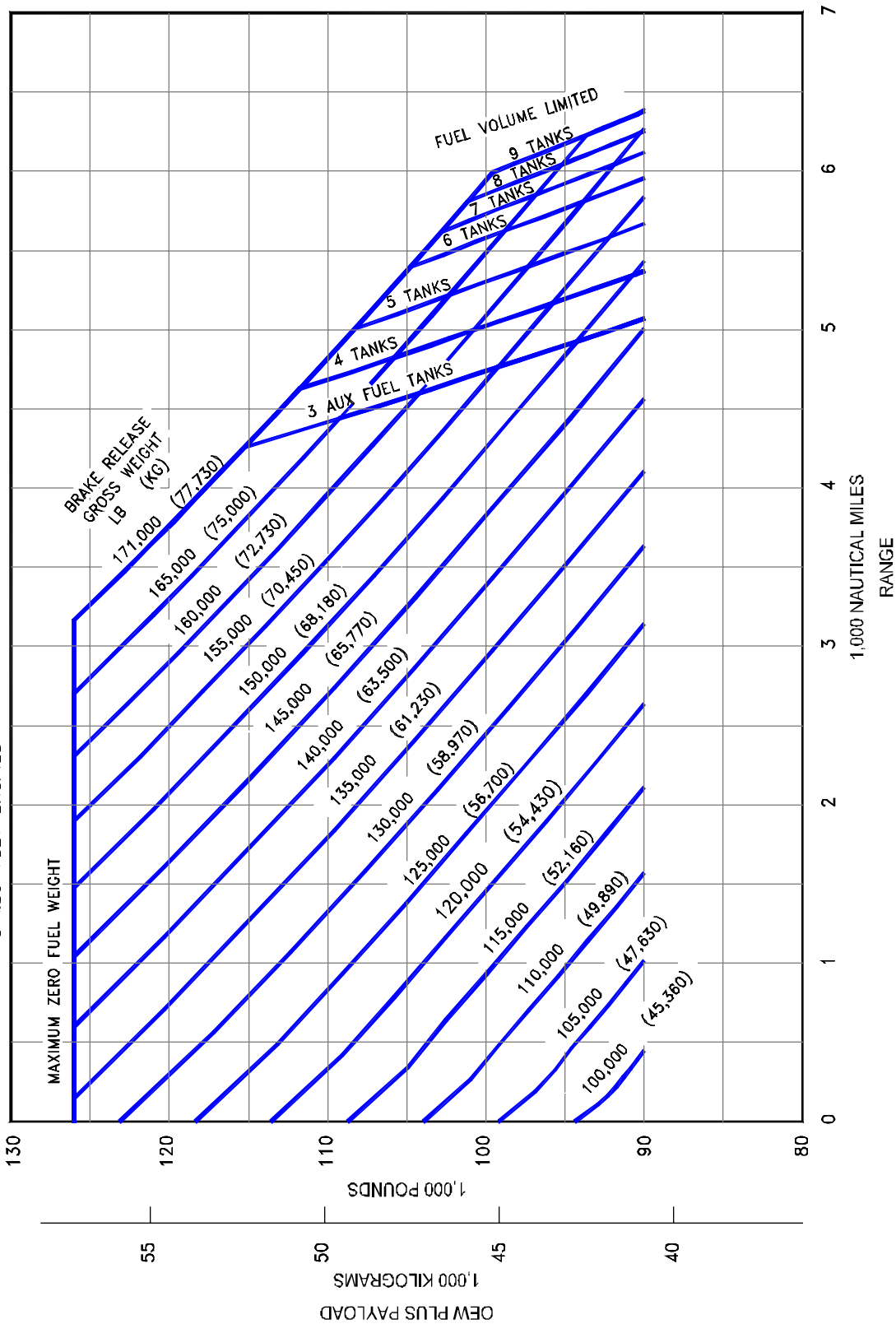

3.2.12 PAYLOAD/RANGE FOR LONG-RANGE CRUISE
 MODEL 737 BBJ

NOTES:

- 31-35-39,000 FT STEP CRUISE
- CRUISE MACH = LRC
- STANDARD DAY, ZERO WIND
- 200 NMI ALTERNATIVE
- TYPICAL MISSION RESERVES
- NOMINAL PERFORMANCE
- CONSULT WITH USING AIRLINE FOR SPECIFIC OPERATING PROCEDURE PRIOR TO FACILITY DESIGN

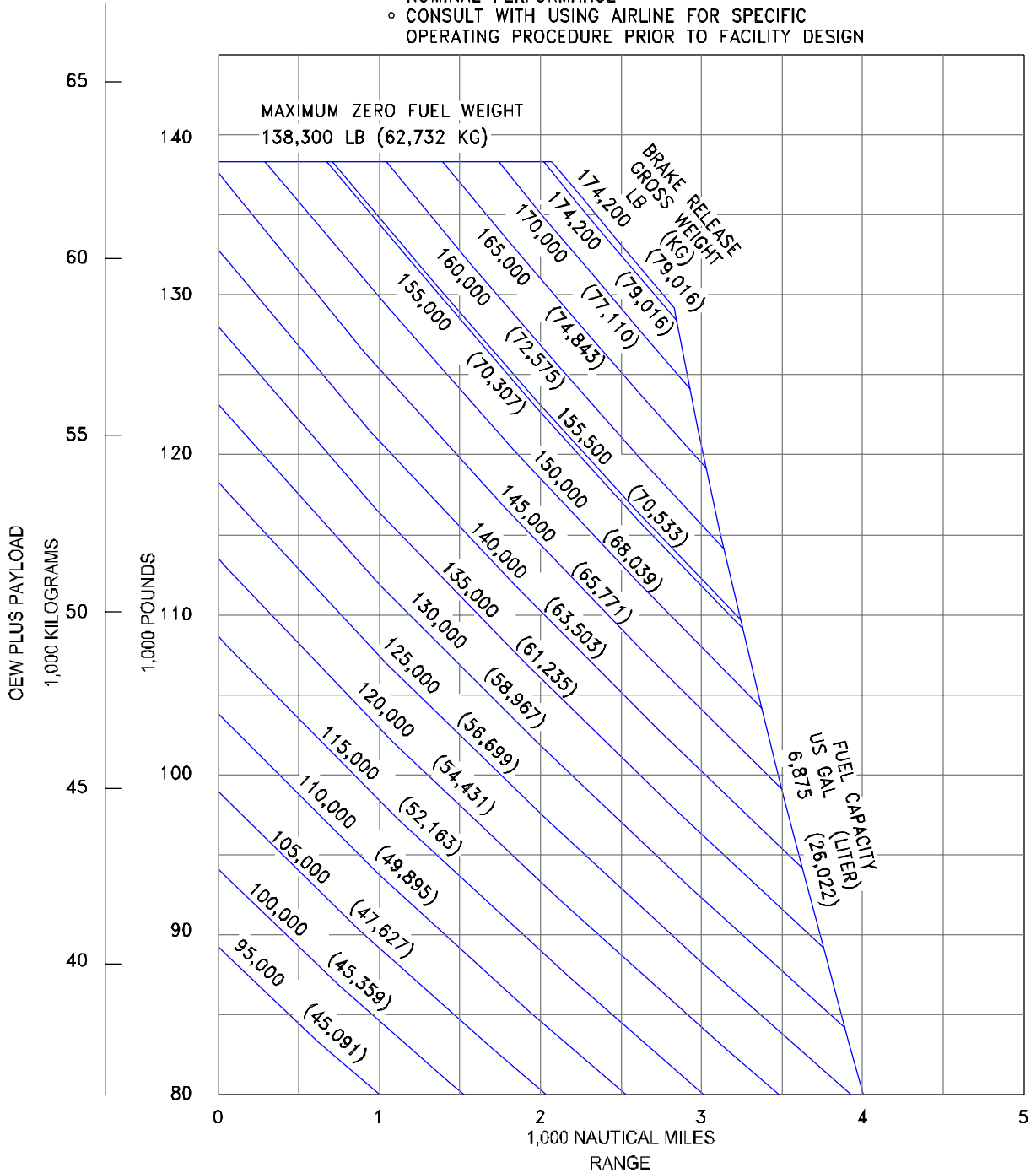

3.2.13 PAYLOAD/RANGE FOR LONG-RANGE CRUISE

MODEL 737-800

- NOTES:
- 31-35-39,000 FT STEP CRUISE
 - CRUISE MACH = LRC
 - STANDARD DAY, ZERO WIND
 - 200 NMI ALTERNATIVE
 - TYPICAL MISSION RESERVES
 - NOMINAL PERFORMANCE
 - CONSULT WITH USING AIRLINE FOR SPECIFIC OPERATING PROCEDURE PRIOR TO FACILITY DESIGN

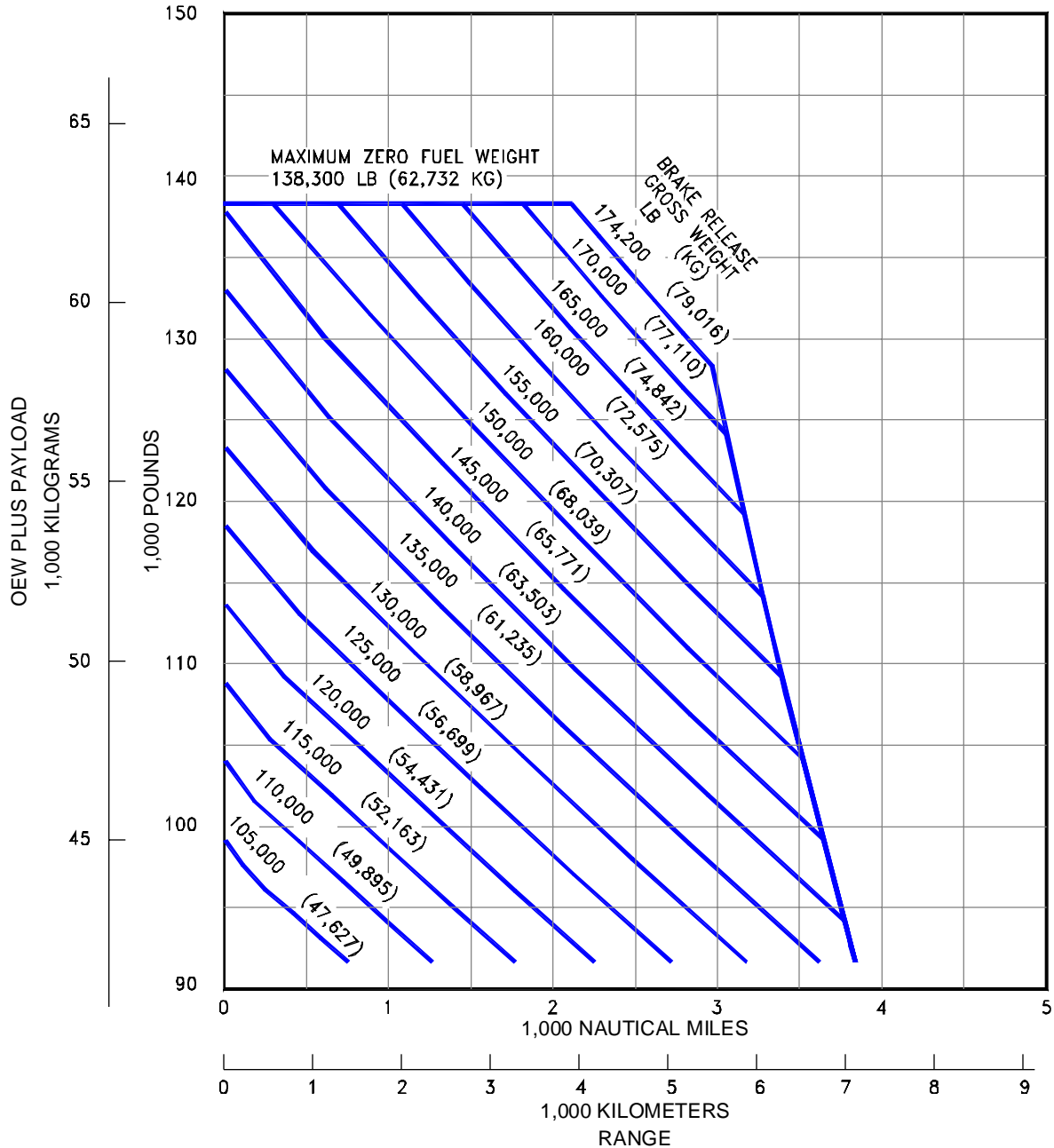

3.2.14 PAYLOAD/RANGE FOR LONG-RANGE CRUISE
 MODEL 737-800 WITH WINGLETS

- NOMINAL PERFORMANCE
- CONSULT WITH USING AIRCRAFT USER FOR SPECIFIC OPERATING PROCEDURE PRIOR TO FACILITY DESIGN

- NOTES:
- NBAA MISSION RULES
 - LONG RANGE CRUISE SPEED
 - 2 A/C PACK OPERATION
 - CFM56-7B27 ENGINES

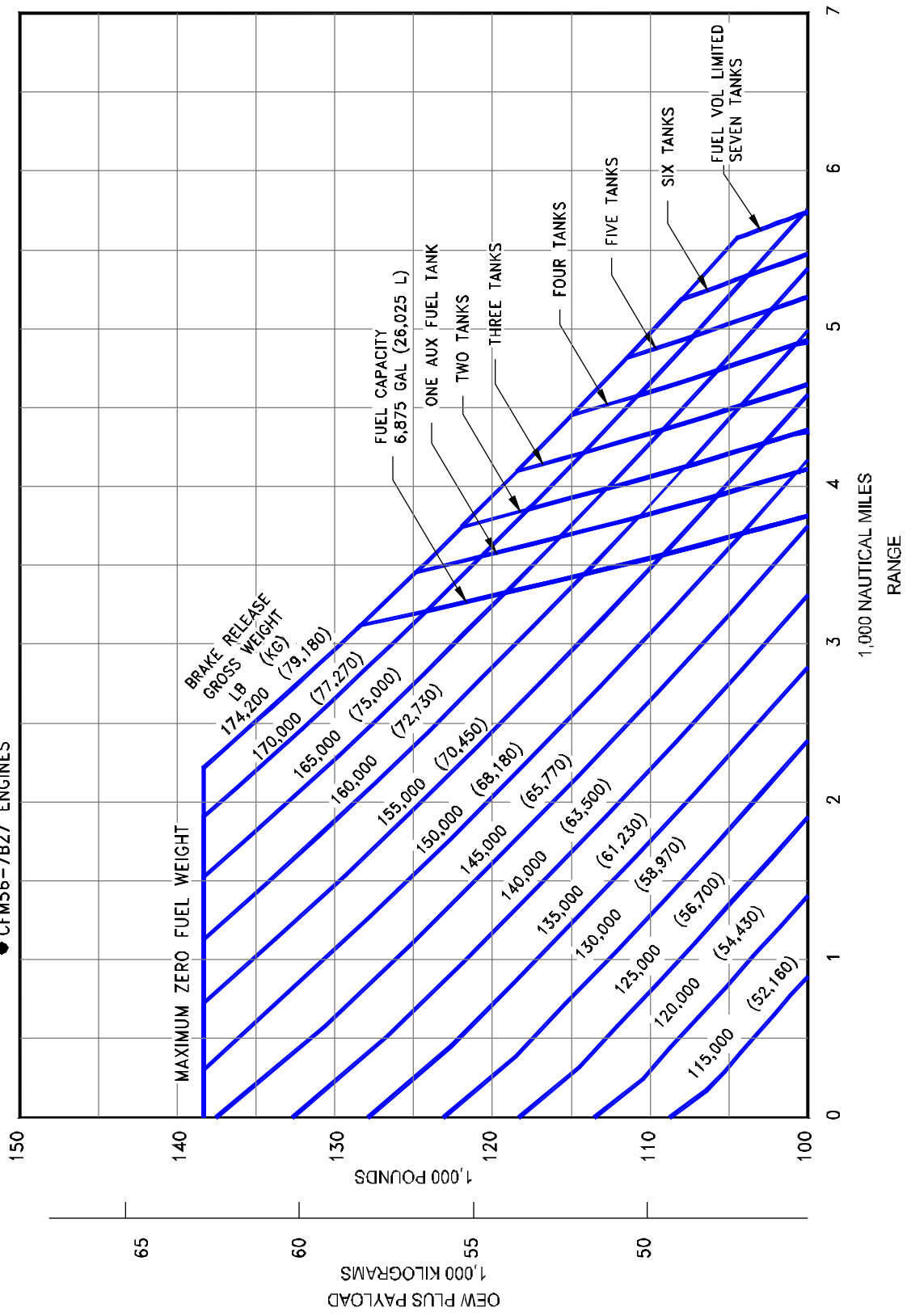

3.2.15 PAYLOAD/RANGE FOR LONG-RANGE CRUISE

MODEL 737 BBJ2

- NOTES:
- 31-35-39,000 FT STEP CRUISE
 - CRUISE MACH = LRC
 - STANDARD DAY, ZERO WIND
 - 200 NMI ALTERNATIVE
 - TYPICAL MISSION RESERVES
 - NOMINAL PERFORMANCE
 - CONSULT WITH USING AIRLINE FOR SPECIFIC OPERATING PROCEDURE PRIOR TO FACILITY DESIGN

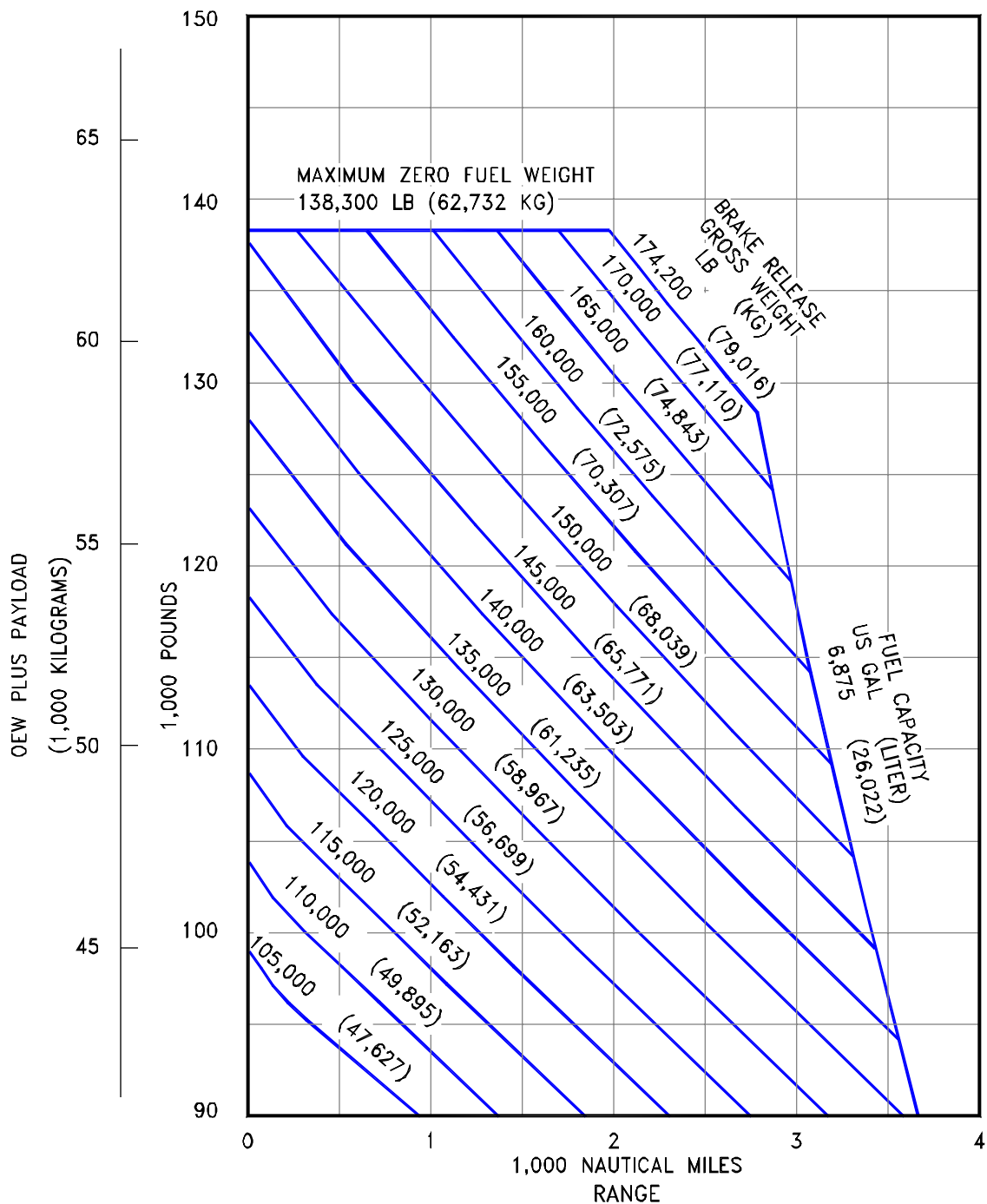

3.2.16 PAYLOAD/RANGE FOR LONG-RANGE CRUISE
 MODEL 737-900

NOTES:

- 31-35-39,000 FT STEP CRUISE
- CRUISE MACH = LRC
- STANDARD DAY, ZERO WIND
- 200 NMI ALTERNATIVE
- TYPICAL MISSION RESERVES
- NOMINAL PERFORMANCE
- CONSULT WITH USING AIRLINE FOR SPECIFIC OPERATING PROCEDURE PRIOR TO FACILITY DESIGN

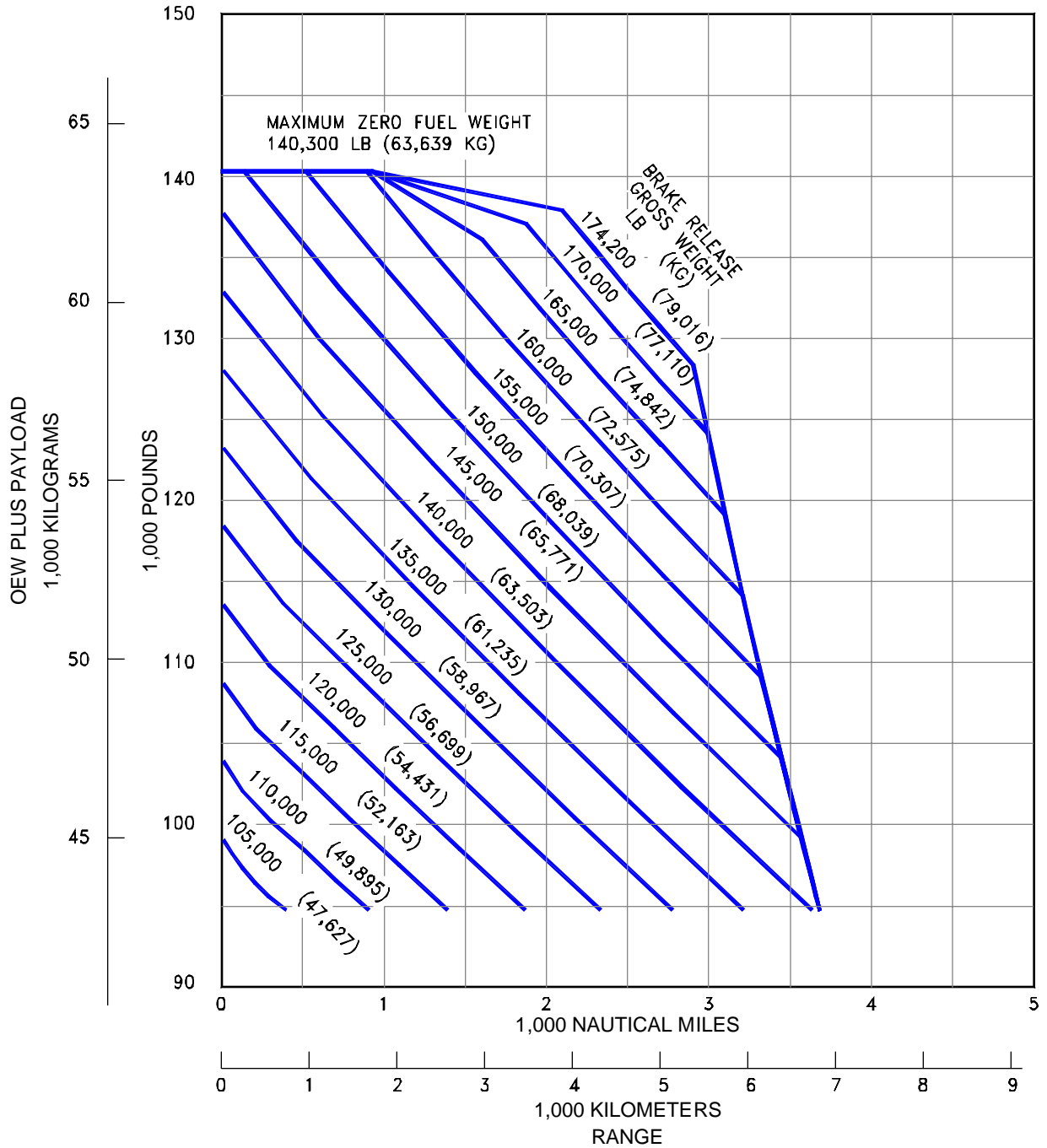

3.2.17 PAYLOAD/RANGE FOR LONG-RANGE CRUISE
MODEL 737-900 WITH WINGLETS

PRELIMINARY INFORMATION

NOTES:

- 31-35-39,000 FT STEP CRUISE
- CRUISE MACH = LRC
- STANDARD DAY, ZERO WIND
- 200 NMI ALTERNATIVE
- TYPICAL MISSION RESERVES
- NOMINAL PERFORMANCE
- CONSULT WITH USING AIRLINE FOR SPECIFIC OPERATING PROCEDURE PRIOR TO FACILITY DESIGN

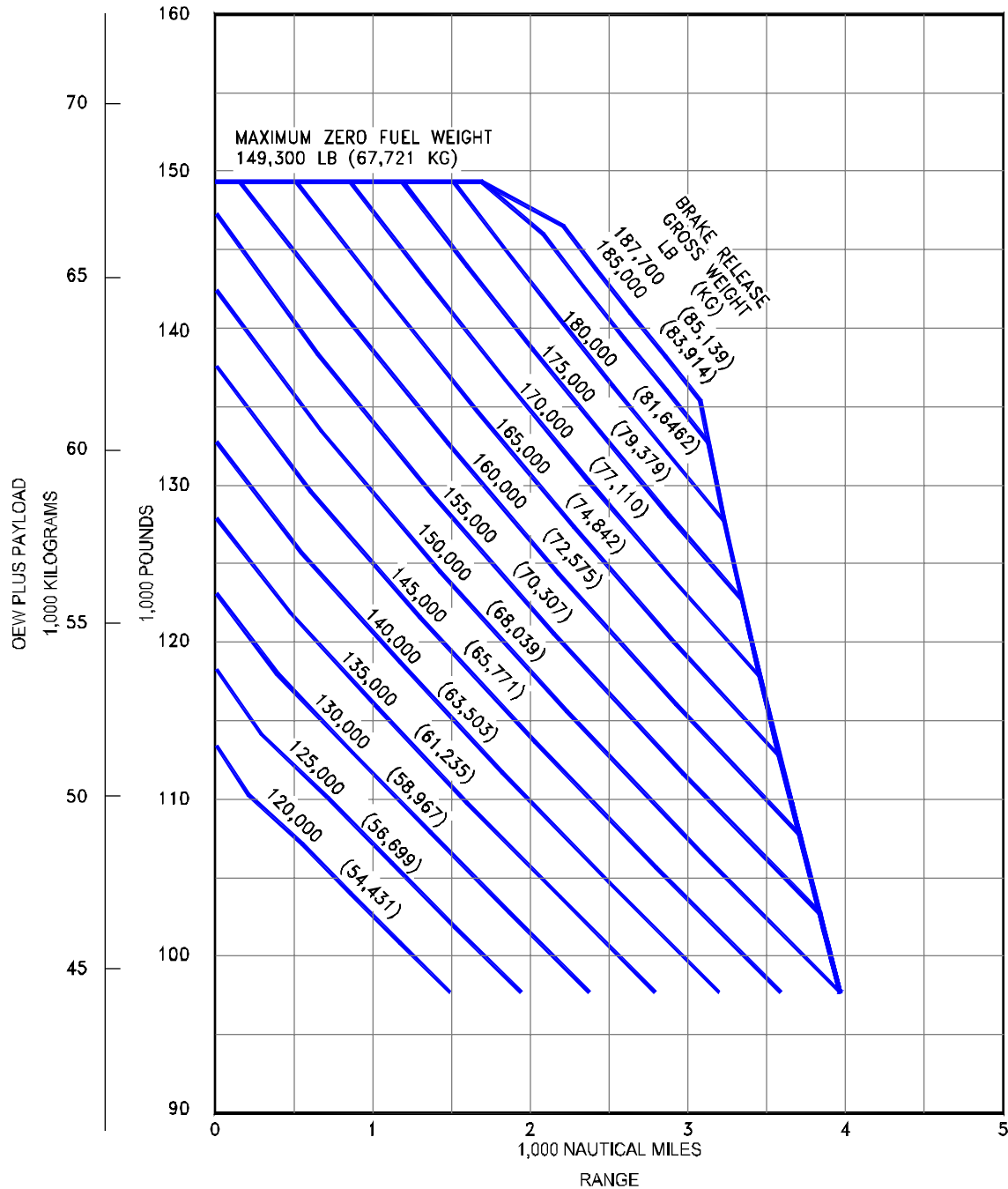

3.2.18 PAYLOAD/RANGE FOR LONG-RANGE CRUISE
MODEL 737-900ER

D6-58325-6

PRELIMINARY INFORMATION

NOTES:

- 31-35-39,000 FT STEP CRUISE
- CRUISE MACH = LRC
- STANDARD DAY, ZERO WIND
- 200 NMI ALTERNATIVE
- TYPICAL MISSION RESERVES
- NOMINAL PERFORMANCE
- CONSULT WITH USING AIRLINE FOR SPECIFIC OPERATING PROCEDURE PRIOR TO FACILITY DESIGN

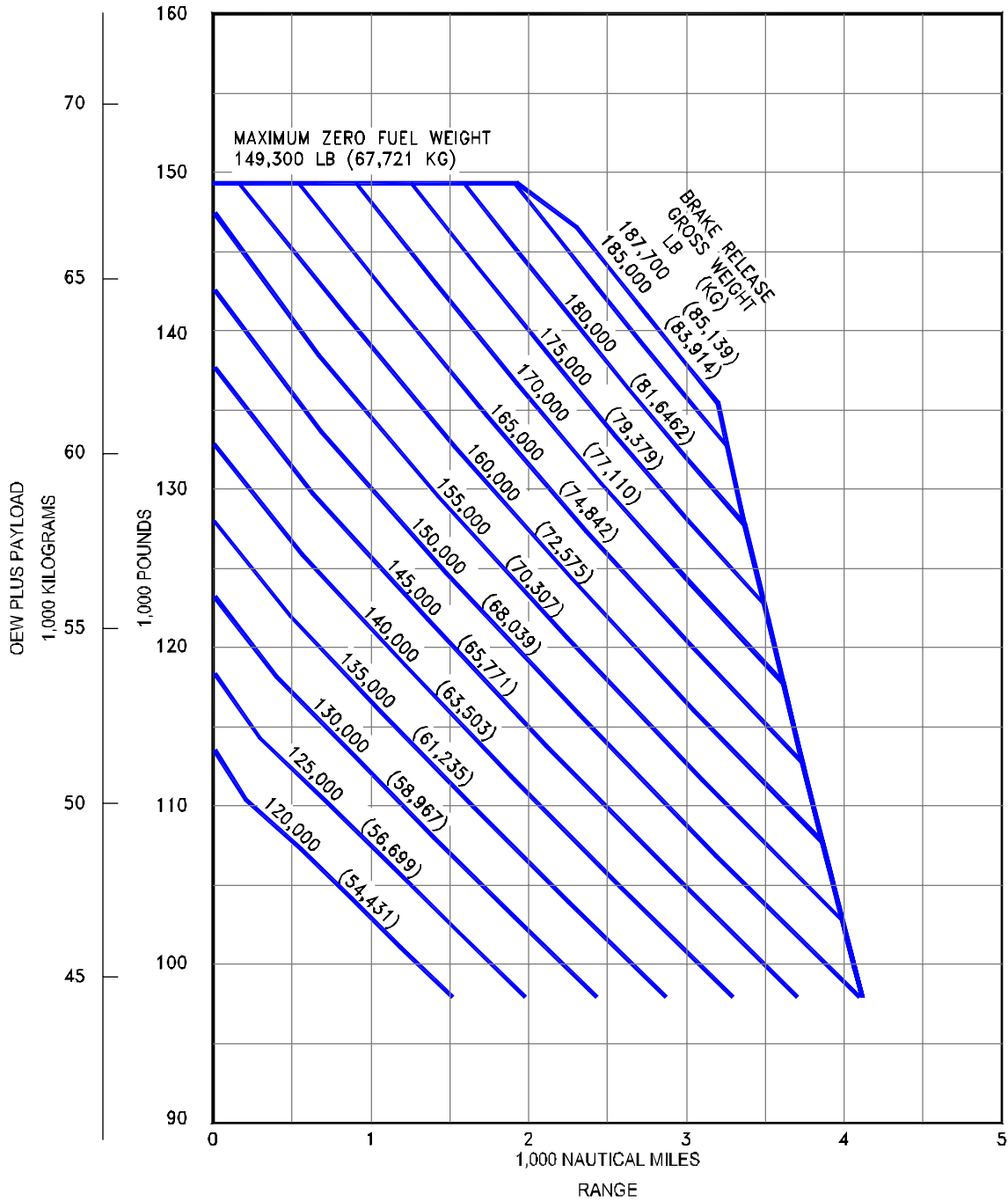

3.2.19 PAYLOAD/RANGE FOR LONG-RANGE CRUISE
MODEL 737-900ER WITH WINGLETS

NOTES:

- * NO ENGINE AIRBLEED FOR AIR CONDITIONING
- * ZERO WIND, ZERO RUNWAY GRADIENT
- * CONSULT USING AIRLINE FOR SPECIFIC OPERATING PROCEDURE PRIOR TO FACILITY DESIGN
- * JT8D-7 ENGINES

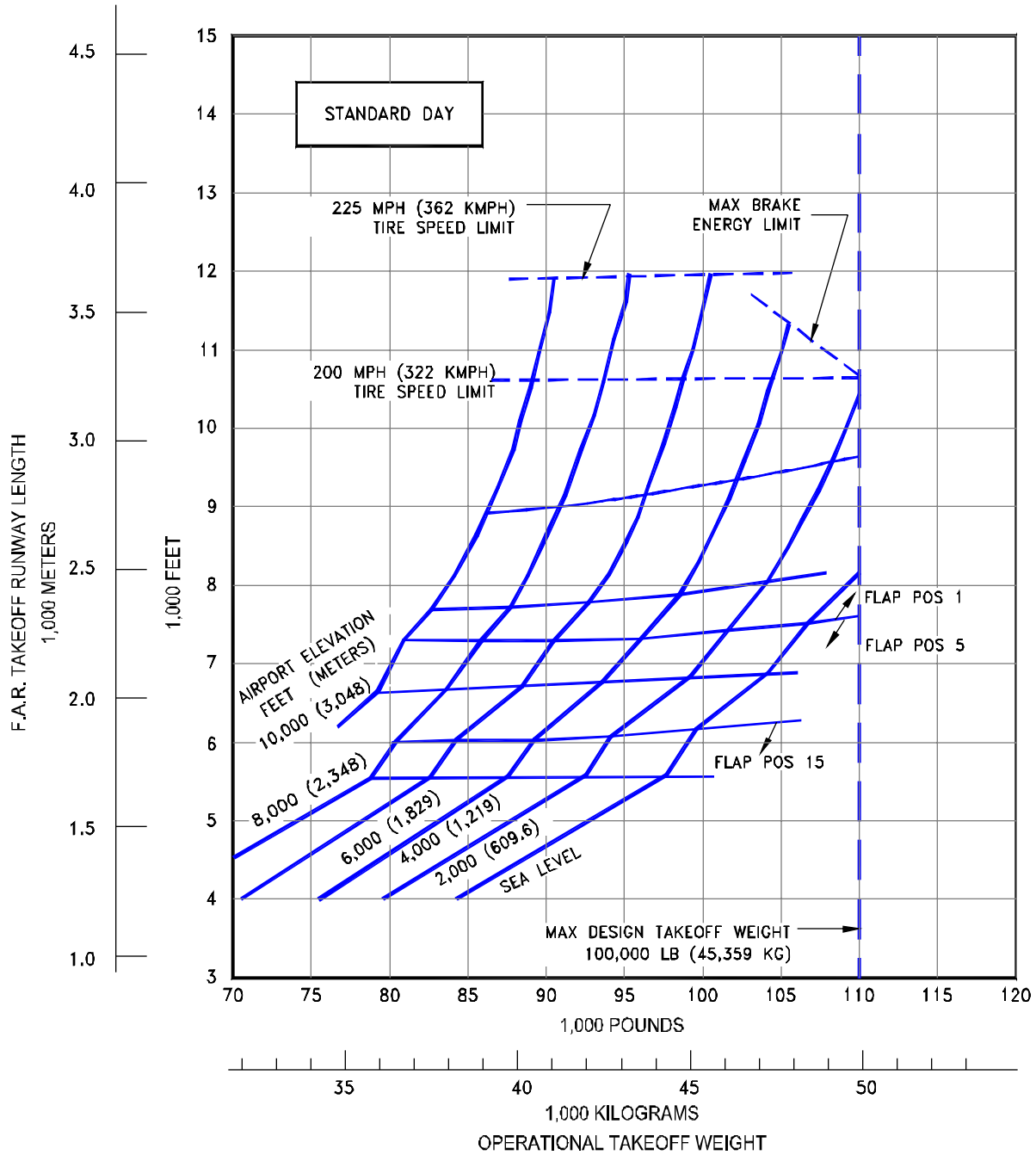

**3.3.1 F.A.R. TAKEOFF RUNWAY LENGTH REQUIREMENTS
STANDARD DAY**

MODEL 737-100 (JT8D-7 ENGINES)

D6-58325-6

NOTES:

- * NO ENGINE AIRBLEED FOR AIR CONDITIONING
- * ZERO WIND, ZERO RUNWAY GRADIENT
- * CONSULT USING AIRLINE FOR SPECIFIC OPERATING PROCEDURE PRIOR TO FACILITY DESIGN
- * JT8D-7 ENGINES

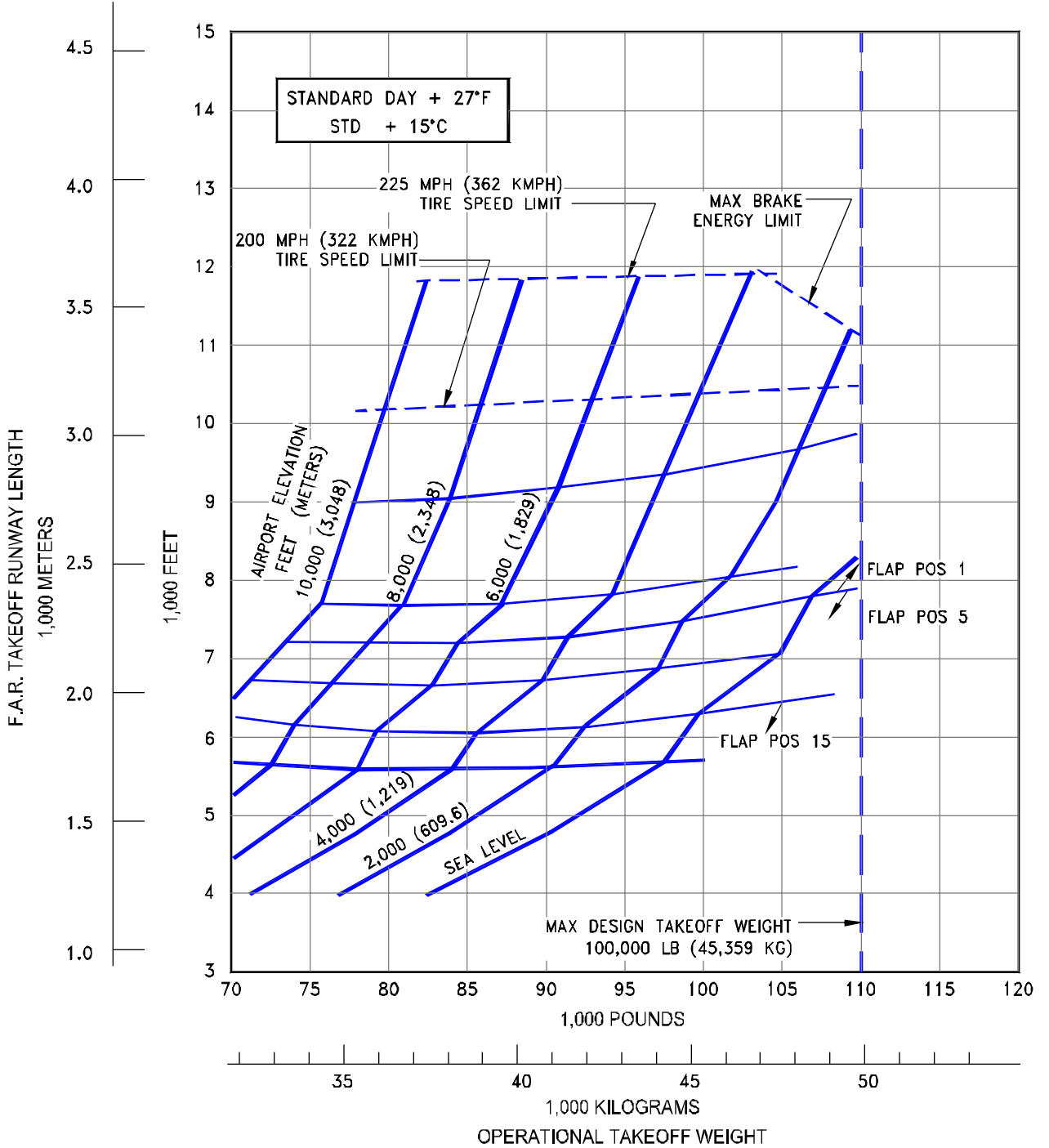

3.3.2 F.A.R. TAKEOFF RUNWAY LENGTH REQUIREMENTS

STANDARD DAY +27°F (STD + 15°C)

MODEL 737-100 (JT8D-7 ENGINES)

NOTES:

- * NO ENGINE AIRBLEED FOR AIR CONDITIONING
- * ZERO WIND, ZERO RUNWAY GRADIENT
- * CONSULT USING AIRLINE FOR SPECIFIC OPERATING PROCEDURE PRIOR TO FACILITY DESIGN
- * JT8D-9/9A ENGINES

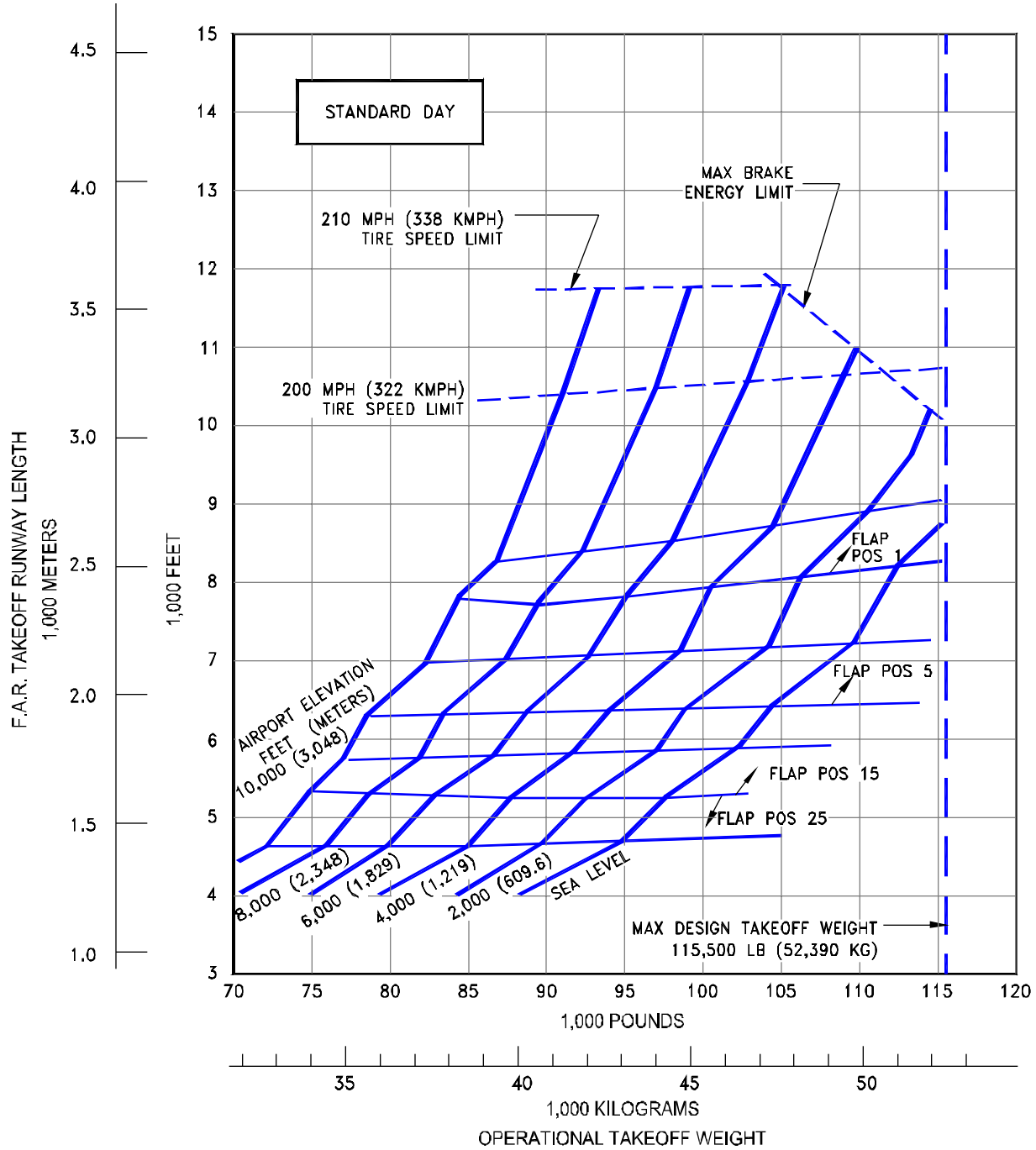

**3.3.2 F.A.R. TAKEOFF RUNWAY LENGTH REQUIREMENTS
STANDARD DAY**

MODEL 737-200 (JT8D-9/9A ENGINES)

D6-58325-6

NOTES:

- * NO ENGINE AIRBLEED FOR AIR CONDITIONING
- * ZERO WIND, ZERO RUNWAY GRADIENT
- * CONSULT USING AIRLINE FOR SPECIFIC OPERATING PROCEDURE PRIOR TO FACILITY DESIGN
- * JT8D-9/9A ENGINES

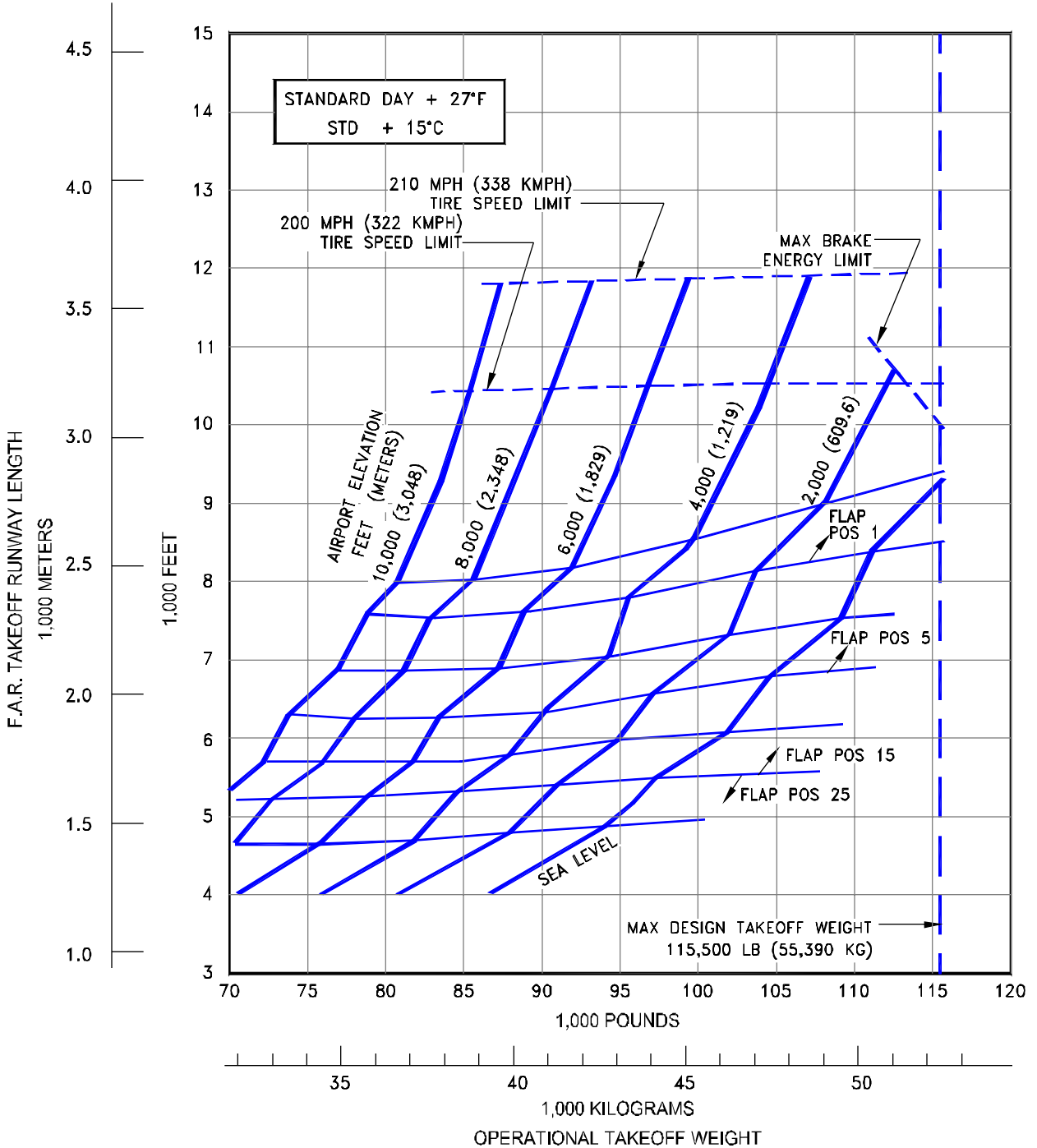

3.3.4 F.A.R. TAKEOFF RUNWAY LENGTH REQUIREMENTS
STANDARD DAY +27°F (STD + 15°C)
MODEL 737-200 (JT8D-9/9A ENGINES)

NOTES:

- * NO ENGINE AIRBLEED FOR AIR CONDITIONING
- * ZERO WIND, ZERO RUNWAY GRADIENT
- * CONSULT USING AIRLINE FOR SPECIFIC OPERATING PROCEDURE PRIOR TO FACILITY DESIGN
- * JT8D-15/15A ENGINES

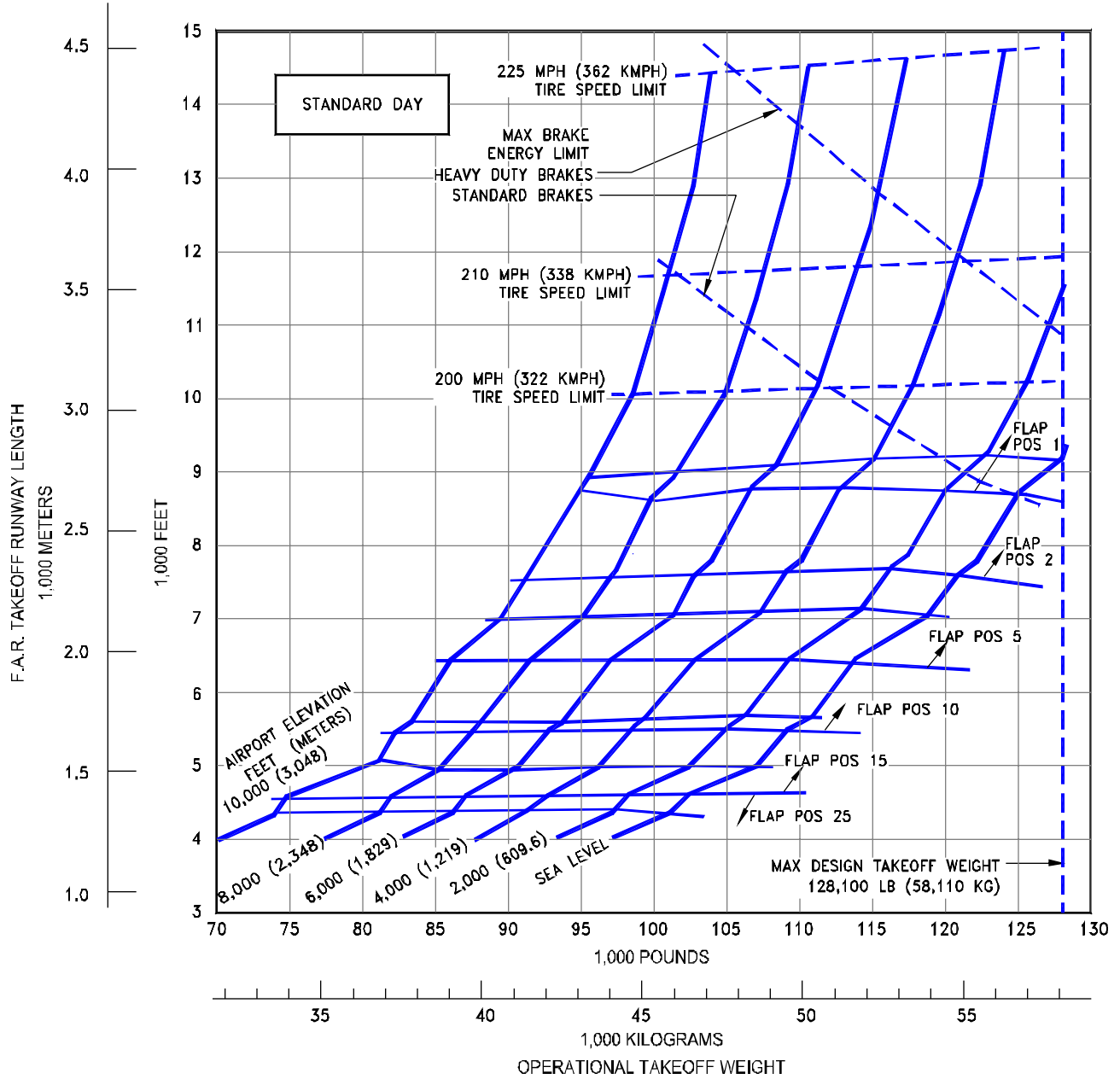

**3.3.5 F.A.R. TAKEOFF RUNWAY LENGTH REQUIREMENTS
STANDARD DAY**

MODEL ADVANCED 737-200 (JT8D-15/15A ENGINES)

D6-58325-6

NOTES:

- * NO ENGINE AIRBLEED FOR AIR CONDITIONING
- * ZERO WIND, ZERO RUNWAY GRADIENT
- * CONSULT USING AIRLINE FOR SPECIFIC OPERATING PROCEDURE PRIOR TO FACILITY DESIGN
- * JT8D-15/15A ENGINES

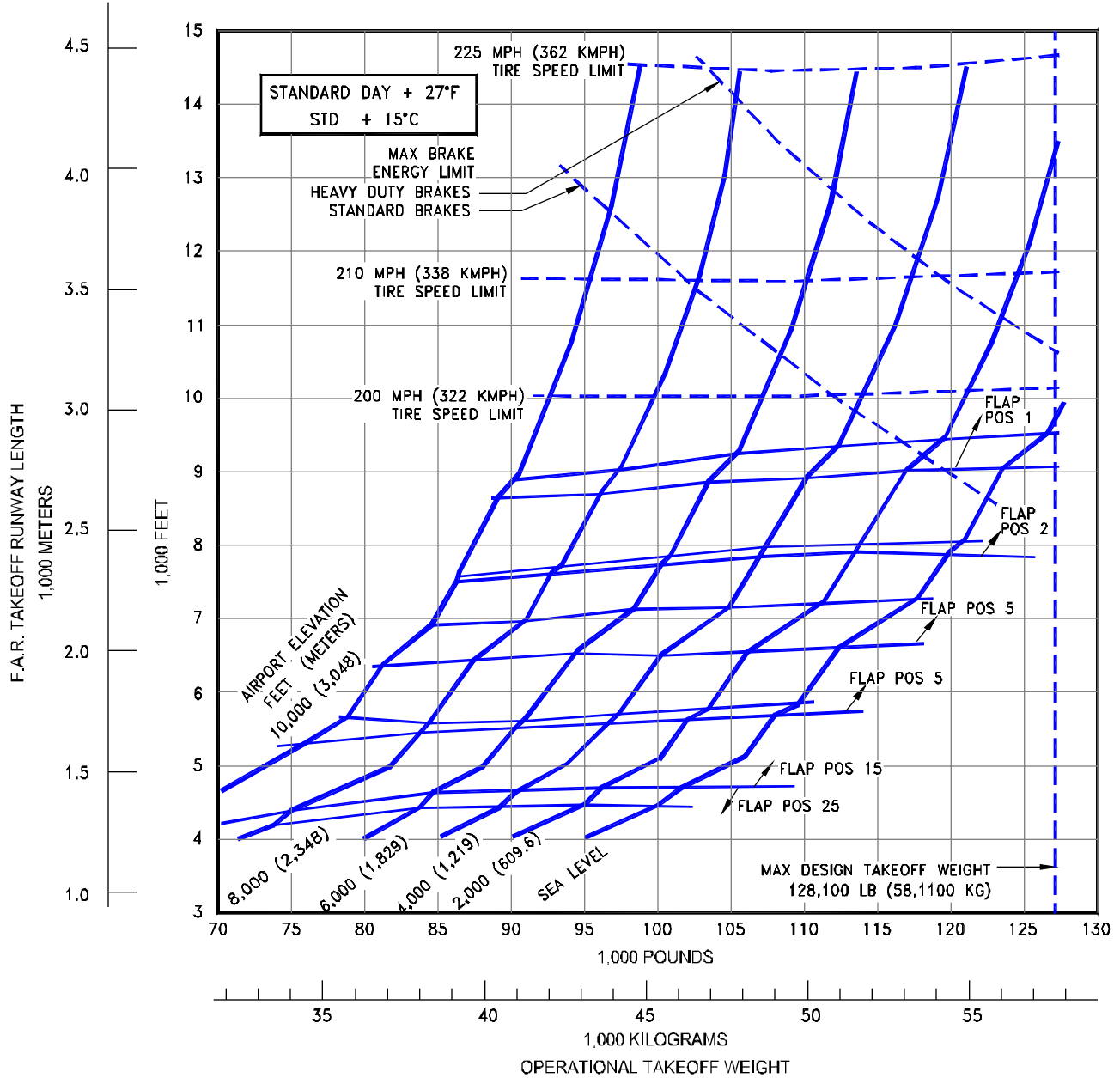

3.3.6 F.A.R. TAKEOFF RUNWAY LENGTH REQUIREMENTS

STANDARD DAY +27°F (STD + 15°C)

MODEL ADVANCED 737-200 (JT8D-15/15A ENGINES)

NOTES:

- * NO ENGINE AIRBLEED FOR AIR CONDITIONING
- * ZERO WIND, ZERO RUNWAY GRADIENT
- * CONSULT USING AIRLINE FOR SPECIFIC OPERATING PROCEDURE PRIOR TO FACILITY DESIGN
- * JT8D-17/17A ENGINES

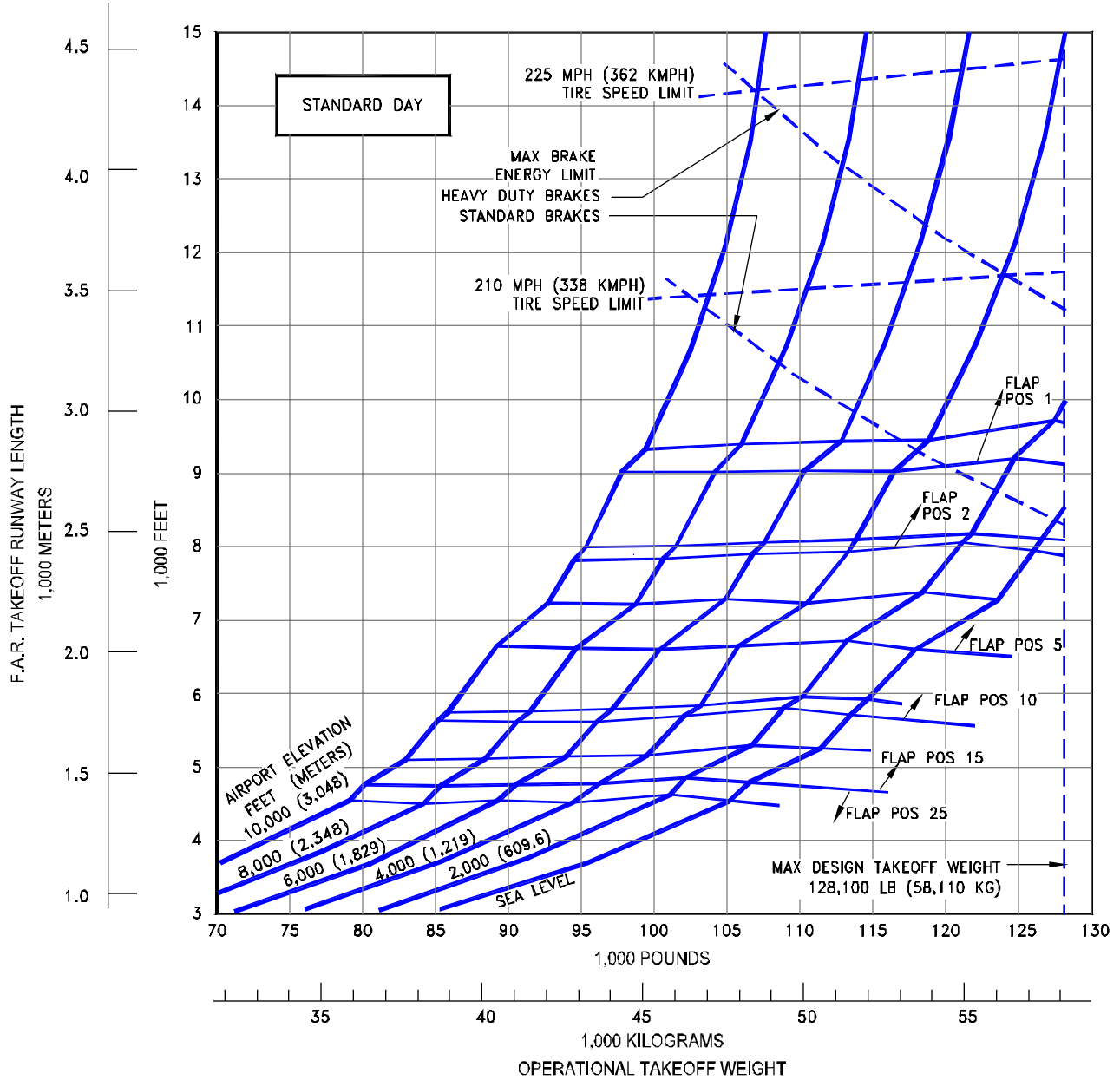

**3.3.7 F.A.R. TAKEOFF RUNWAY LENGTH REQUIREMENTS
STANDARD DAY**

MODEL ADVANCED 737-200 (JT8D-17/17A ENGINES)

D6-58325-6

NOTES:

- * NO ENGINE AIRBLEED FOR AIR CONDITIONING
- * ZERO WIND, ZERO RUNWAY GRADIENT
- * CONSULT USING AIRLINE FOR SPECIFIC OPERATING PROCEDURE PRIOR TO FACILITY DESIGN
- * JT8D-17/17A ENGINES

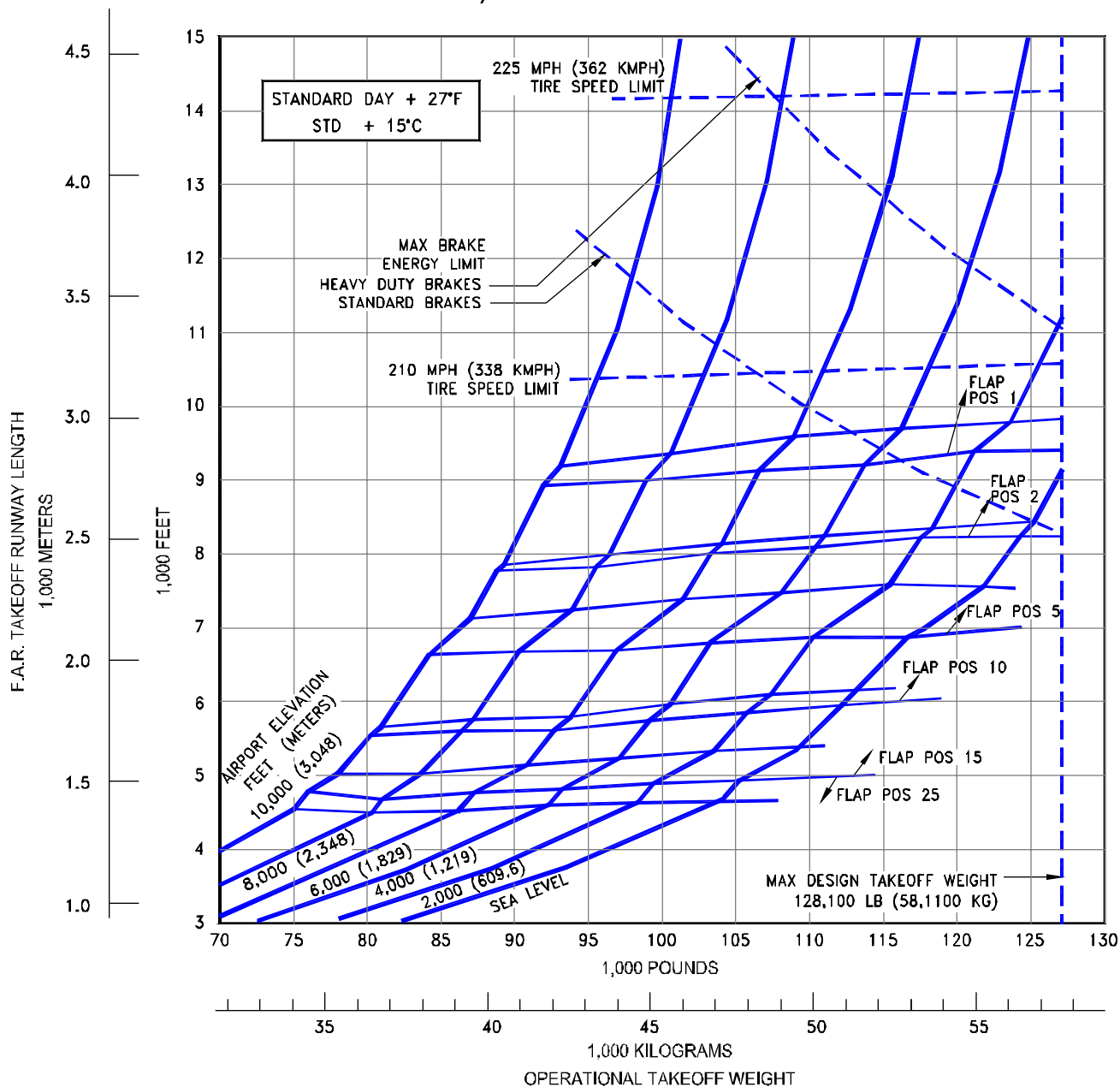

3.3.8 F.A.R. TAKEOFF RUNWAY LENGTH REQUIREMENTS

STANDARD DAY +27°F (STD + 15°C)

MODEL ADVANCED 737-200 (JT8D-17/17A ENGINES)

NOTES:

- * NO ENGINE AIRBLEED FOR AIR CONDITIONING
- * ZERO WIND, ZERO RUNWAY GRADIENT
- * CONSULT USING AIRLINE FOR SPECIFIC OPERATING PROCEDURE PRIOR TO FACILITY DESIGN
- * JT8D-17R/17AR ENGINES

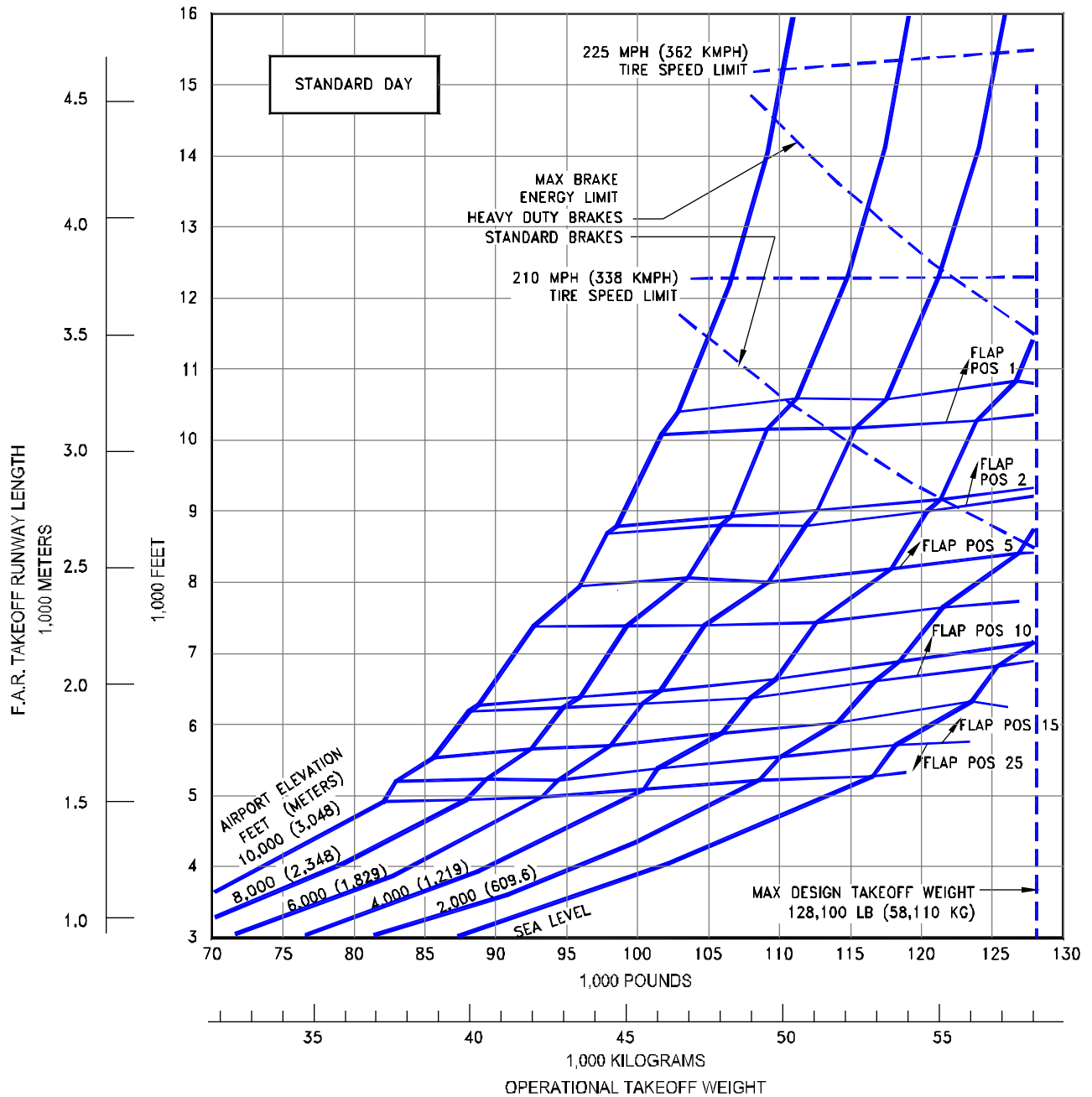

**3.3.9 F.A.R. TAKEOFF RUNWAY LENGTH REQUIREMENTS
STANDARD DAY**

MODEL ADVANCED 737-200 (JT8D-17R/17AR ENGINES)

D6-58325-6

NOTES:

- * NO ENGINE AIRBLEED FOR AIR CONDITIONING
- * ZERO WIND, ZERO RUNWAY GRADIENT
- * CONSULT USING AIRLINE FOR SPECIFIC OPERATING PROCEDURE PRIOR TO FACILITY DESIGN
- * JT8D-17R/17AR ENGINES

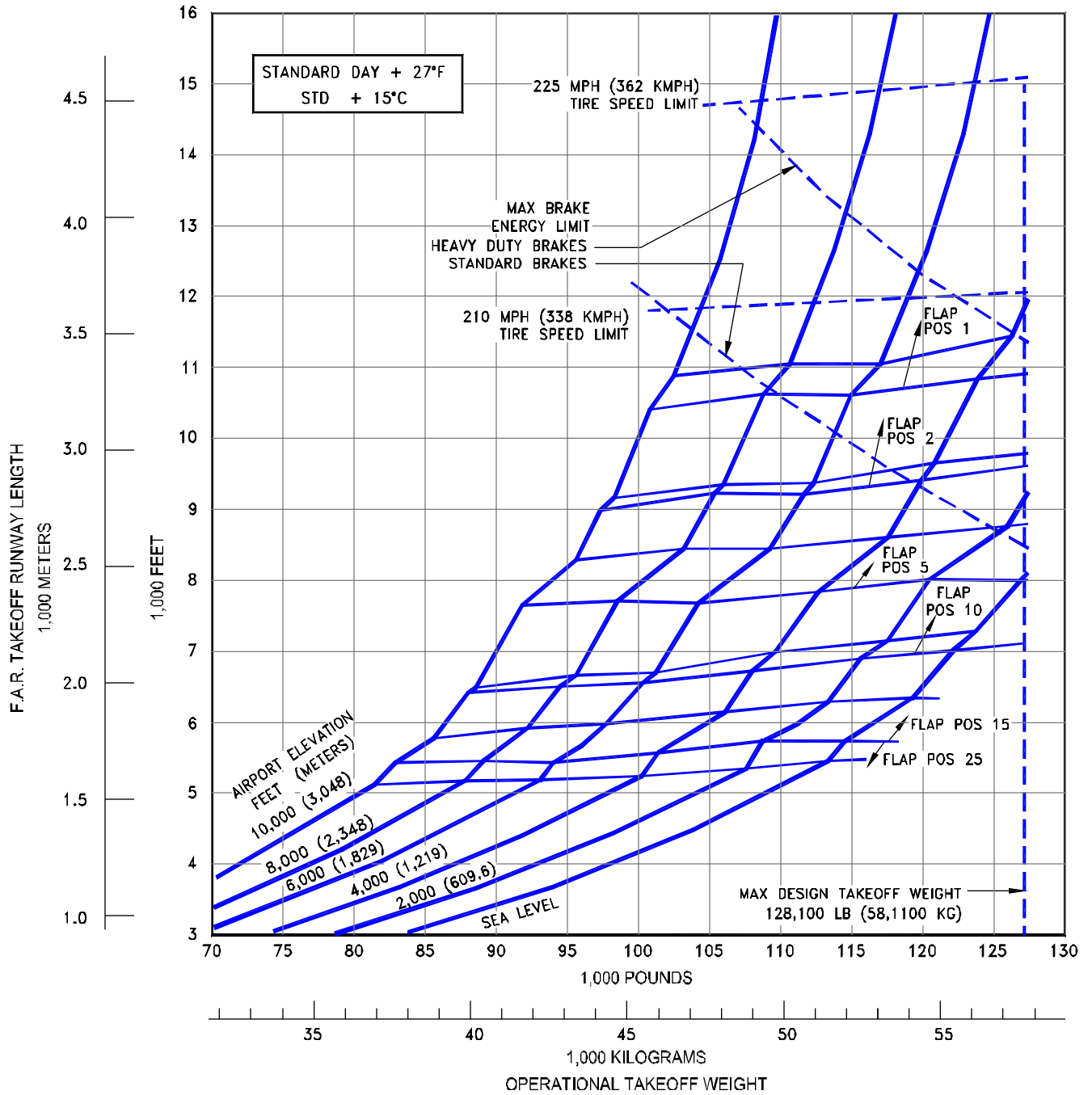

3.3.10 F.A.R. TAKEOFF RUNWAY LENGTH REQUIREMENTS

STANDARD DAY +27°F (STD + 15°C)

MODEL ADVANCED 737-200 (JT8D-17R/17AR ENGINES)

NOTES:

- * NO ENGINE AIRBLEED FOR AIR CONDITIONING
- * ZERO WIND, ZERO RUNWAY GRADIENT
- * CONSULT USING AIRLINE FOR SPECIFIC OPERATING PROCEDURE PRIOR TO FACILITY DESIGN
- * CFM 56-3B1 ENGINES RATED AT 20,000 LB SLST

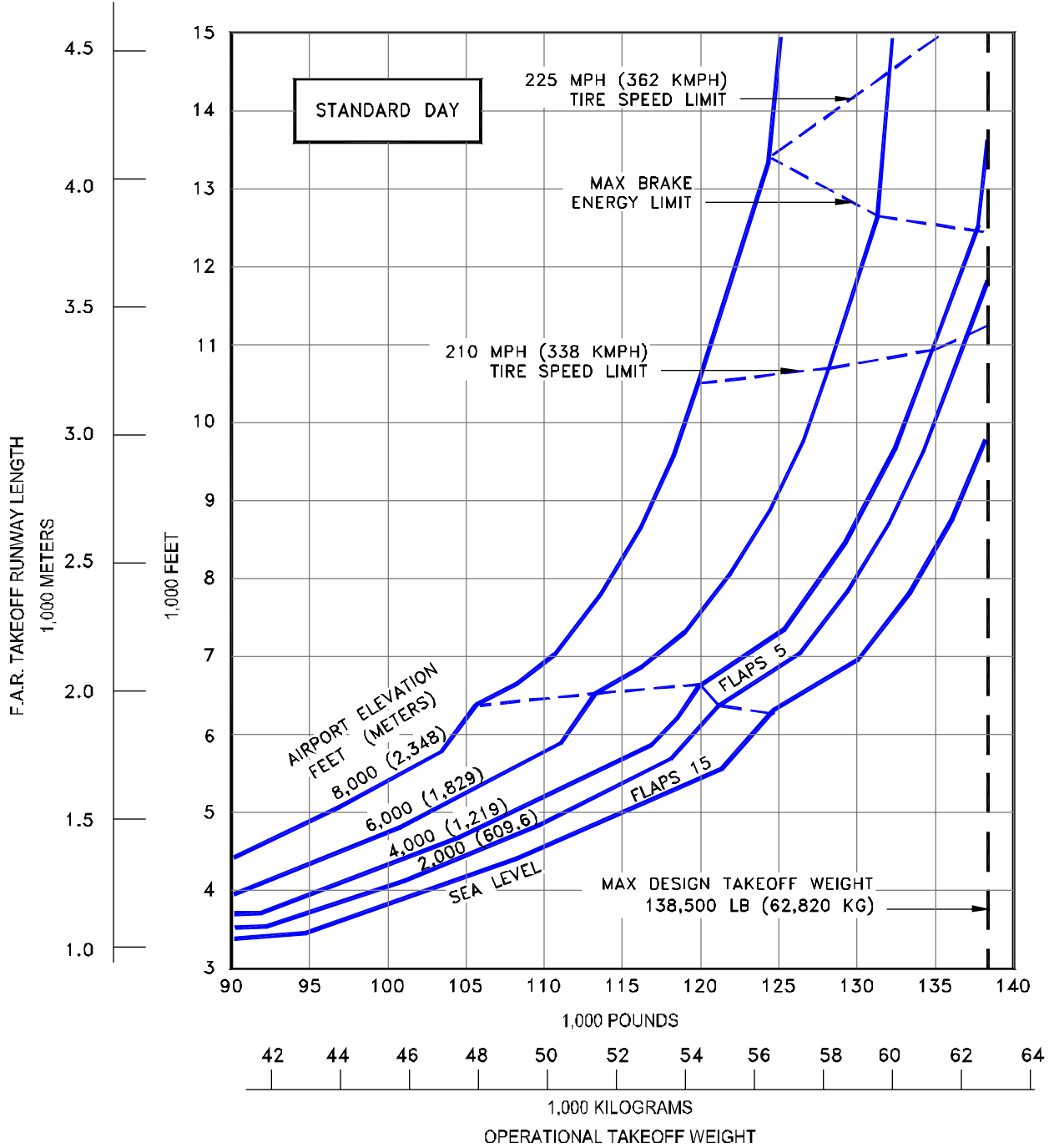

**3.3.11 F.A.R. TAKEOFF RUNWAY LENGTH REQUIREMENTS
STANDARD DAY**

MODEL 737-300 (CFM56-3B1 ENGINES AT 20,000 LB SLST)

D6-58325-6

NOTES:

- * NO ENGINE AIRBLEED FOR AIR CONDITIONING
- * ZERO WIND, ZERO RUNWAY GRADIENT
- * CONSULT USING AIRLINE FOR SPECIFIC OPERATING PROCEDURE PRIOR TO FACILITY DESIGN
- * CFM 56-3B1 ENGINES RATED AT 20,000 LB SLST

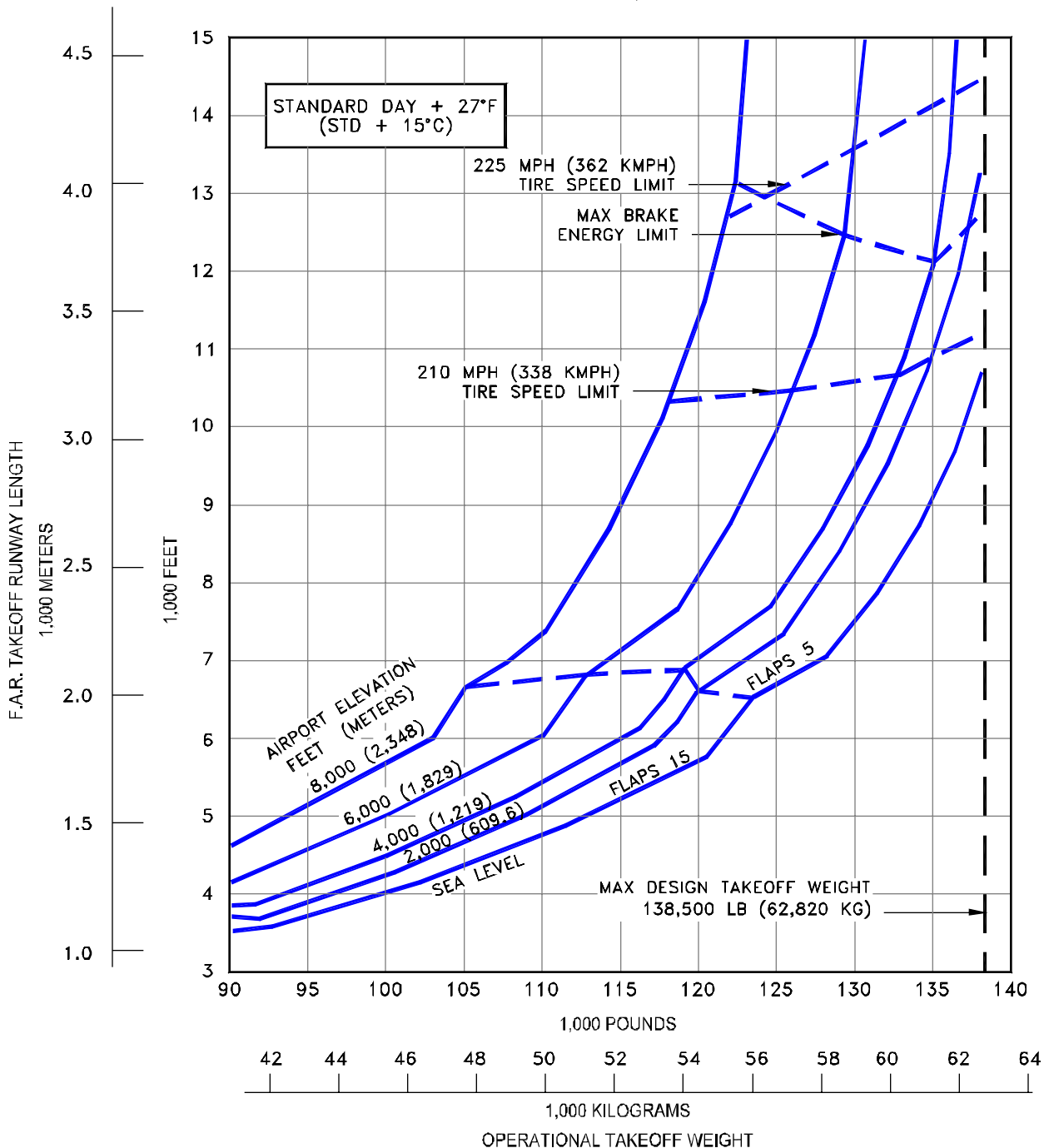

3.3.12 F.A.R. TAKEOFF RUNWAY LENGTH REQUIREMENTS

STANDARD DAY +27°F (STD + 15°C),

MODEL 737-300 (CFM56-3B1 ENGINES AT 20,000 LB SLST)

NOTES:

- * NO ENGINE AIRBLEED FOR AIR CONDITIONING
- * ZERO WIND, ZERO RUNWAY GRADIENT
- * CONSULT USING AIRLINE FOR SPECIFIC OPERATING PROCEDURE PRIOR TO FACILITY DESIGN
- * CFM 56-3B2 ENGINES RATED AT 22,000 LB SLST

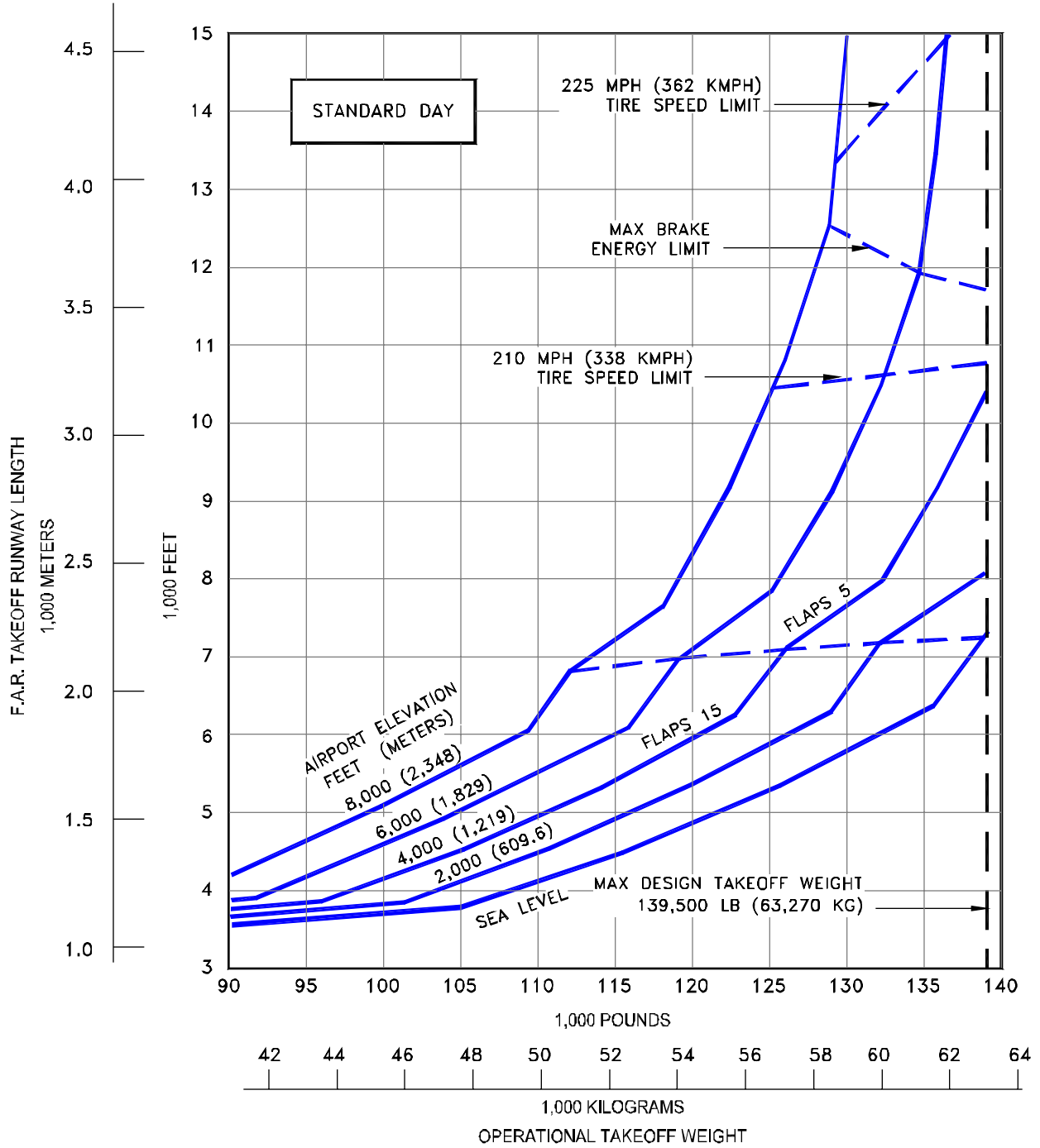

**3.3.13 F.A.R. TAKEOFF RUNWAY LENGTH REQUIREMENTS
STANDARD DAY**

MODEL 737-300 (CFM56-3B-2 ENGINES AT 22,000 LB SLST)

D6-58325-6

NOTES:

- * NO ENGINE AIRBLEED FOR AIR CONDITIONING
- * ZERO WIND, ZERO RUNWAY GRADIENT
- * CONSULT USING AIRLINE FOR SPECIFIC OPERATING PROCEDURE PRIOR TO FACILITY DESIGN
- * CFM 56-3B2 ENGINES RATED AT 22,000 LB SLST

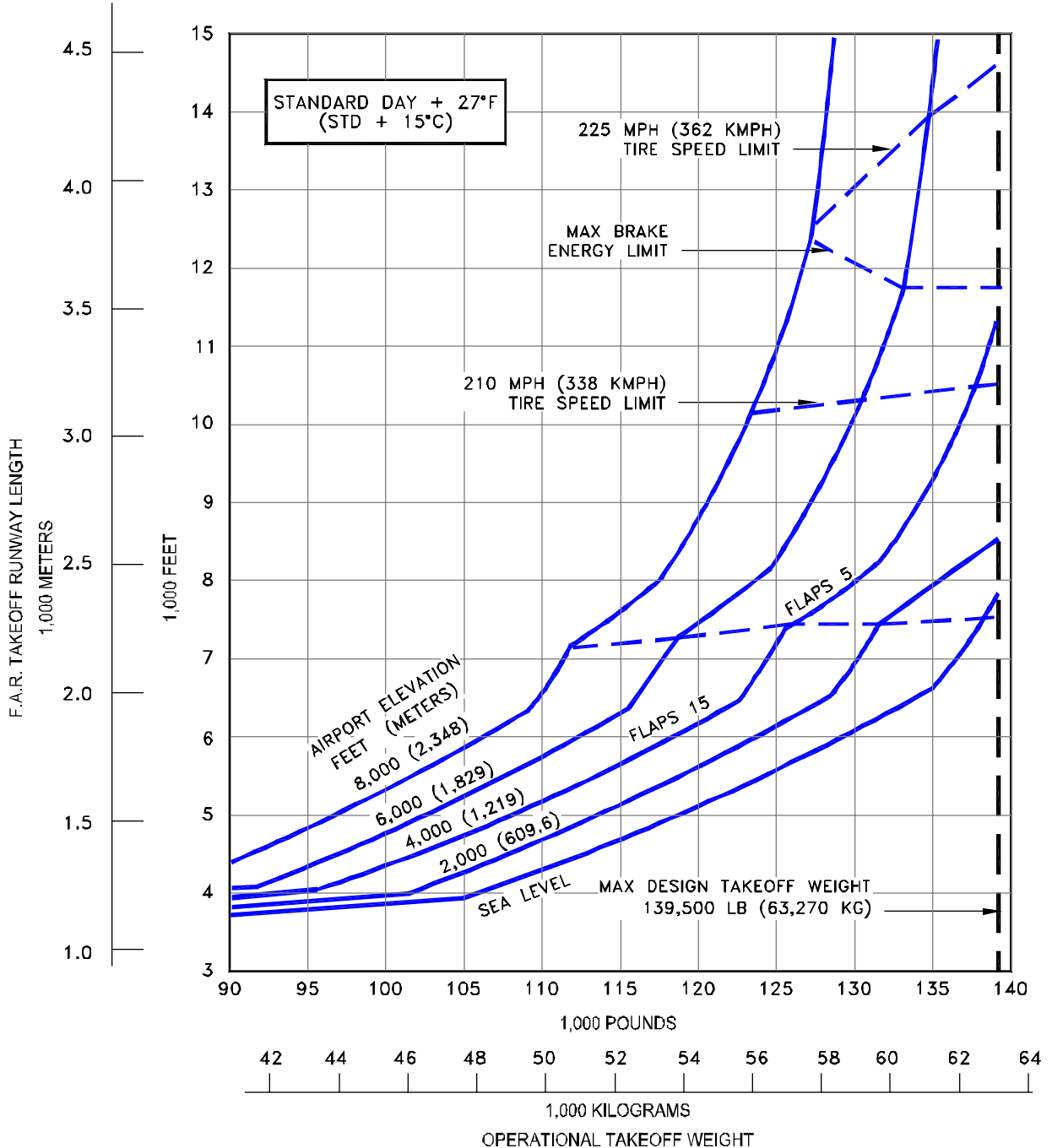

3.3.14 F.A.R. TAKEOFF RUNWAY LENGTH REQUIREMENTS

STANDARD DAY +27°F (STD + 15°C)

MODEL 737-300 (CFM56-3B-2 ENGINES AT 22,000 LB SLST)

NOTES:

- * NO ENGINE AIRBLEED FOR AIR CONDITIONING
- * ZERO WIND, ZERO RUNWAY GRADIENT
- * CONSULT USING AIRLINE FOR SPECIFIC OPERATING PROCEDURE PRIOR TO FACILITY DESIGN
- * CFM 56-3B2 ENGINES RATED AT 22,000 LB SLST

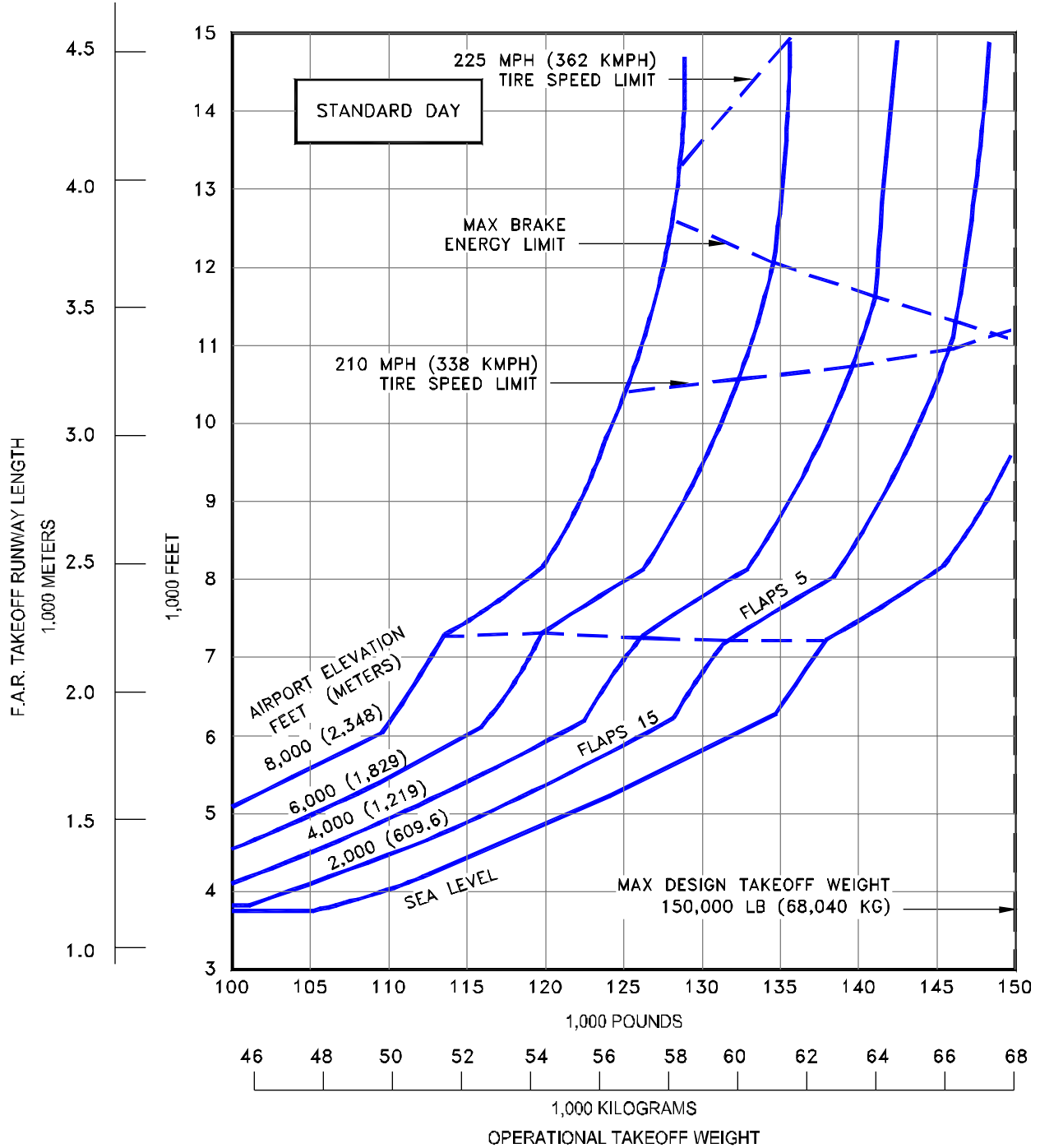

**3.3.15 F.A.R. TAKEOFF RUNWAY LENGTH REQUIREMENTS
STANDARD DAY**

MODEL 737-400 (CFM56-3B-2 ENGINES AT 22,000 LB SLST)

D6-58325-6

NOTES:

- * NO ENGINE AIRBLEED FOR AIR CONDITIONING
- * ZERO WIND, ZERO RUNWAY GRADIENT
- * CONSULT USING AIRLINE FOR SPECIFIC OPERATING PROCEDURE PRIOR TO FACILITY DESIGN
- * CFM 56-3B2 ENGINES RATED AT 22,000 LB SLST

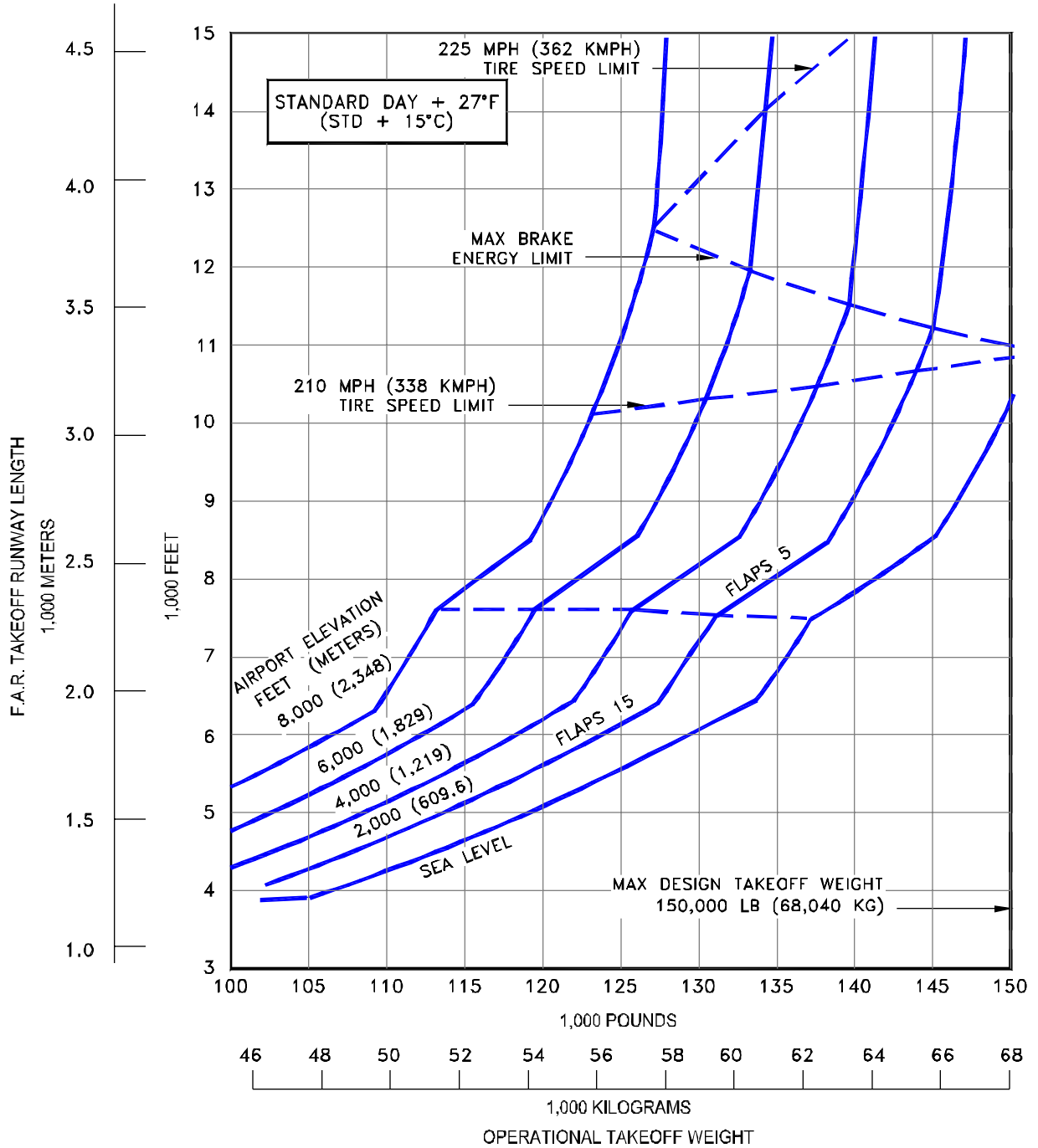

3.3.16 F.A.R. TAKEOFF RUNWAY LENGTH REQUIREMENTS

STANDARD DAY +27°F (STD + 15°C)

MODEL 737-400 (CFM56-3B-2 ENGINES AT 22,000 LB SLST)

NOTES:

- * NO ENGINE AIRBLEED FOR AIR CONDITIONING
- * ZERO WIND, ZERO RUNWAY GRADIENT
- * CONSULT USING AIRLINE FOR SPECIFIC OPERATING PROCEDURE PRIOR TO FACILITY DESIGN
- * CFM 56-3C1 ENGINES RATED AT 23,500 LB SLST

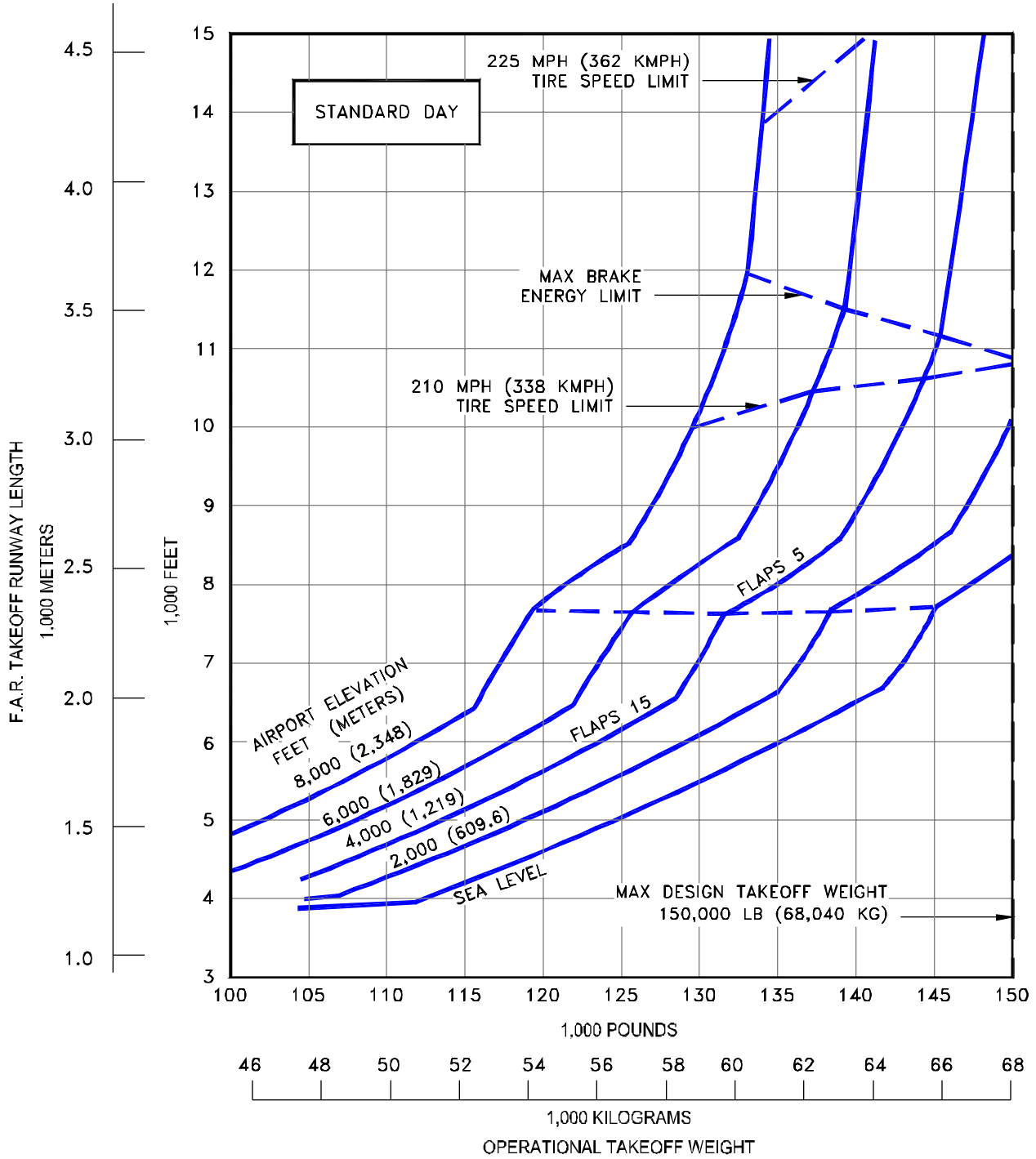

**3.3.17 F.A.R. TAKEOFF RUNWAY LENGTH REQUIREMENTS
STANDARD DAY**

MODEL 737-400 (CFM56-3C1 ENGINES AT 23,500 LB SLST)

D6-58325-6

NOTES:

- * NO ENGINE AIRBLEED FOR AIR CONDITIONING
- * ZERO WIND, ZERO RUNWAY GRADIENT
- * CONSULT USING AIRLINE FOR SPECIFIC OPERATING PROCEDURE PRIOR TO FACILITY DESIGN
- * CFM 56-3C1 ENGINES RATED AT 23,500 LB SLST

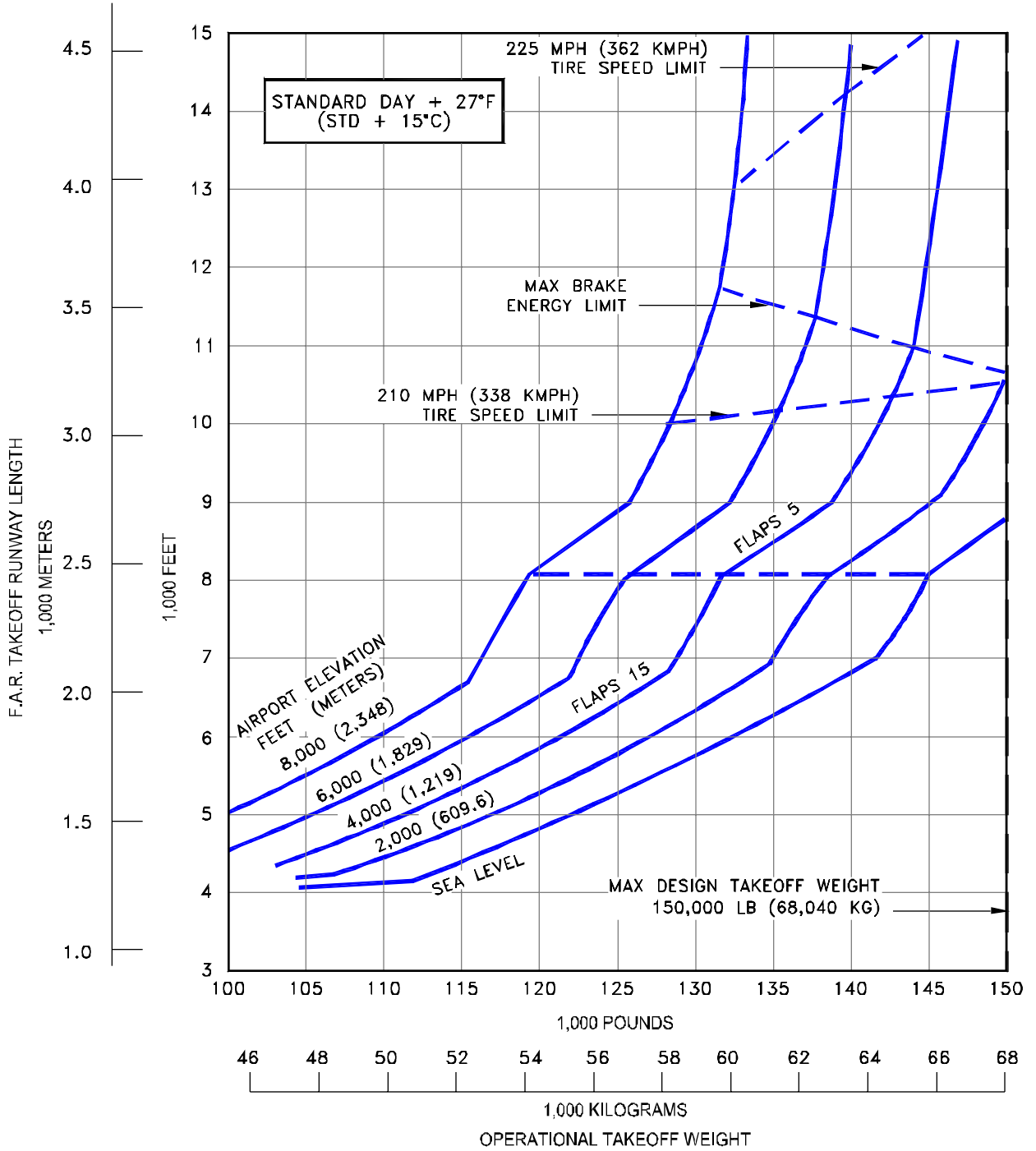

3.3.18 F.A.R. TAKEOFF RUNWAY LENGTH REQUIREMENTS

STANDARD DAY +27°F (STD + 15°C)

MODEL 737-400 (CFM56-3C1 ENGINES AT 23,500 LB SLST)

D6-58325-6

NOTES:

- * NO ENGINE AIRBLEED FOR AIR CONDITIONING
- * ZERO WIND, ZERO RUNWAY GRADIENT
- * CONSULT USING AIRLINE FOR SPECIFIC OPERATING PROCEDURE PRIOR TO FACILITY DESIGN
- * CFM 56-3B1 ENGINES RATED AT 20,000 LB SLST

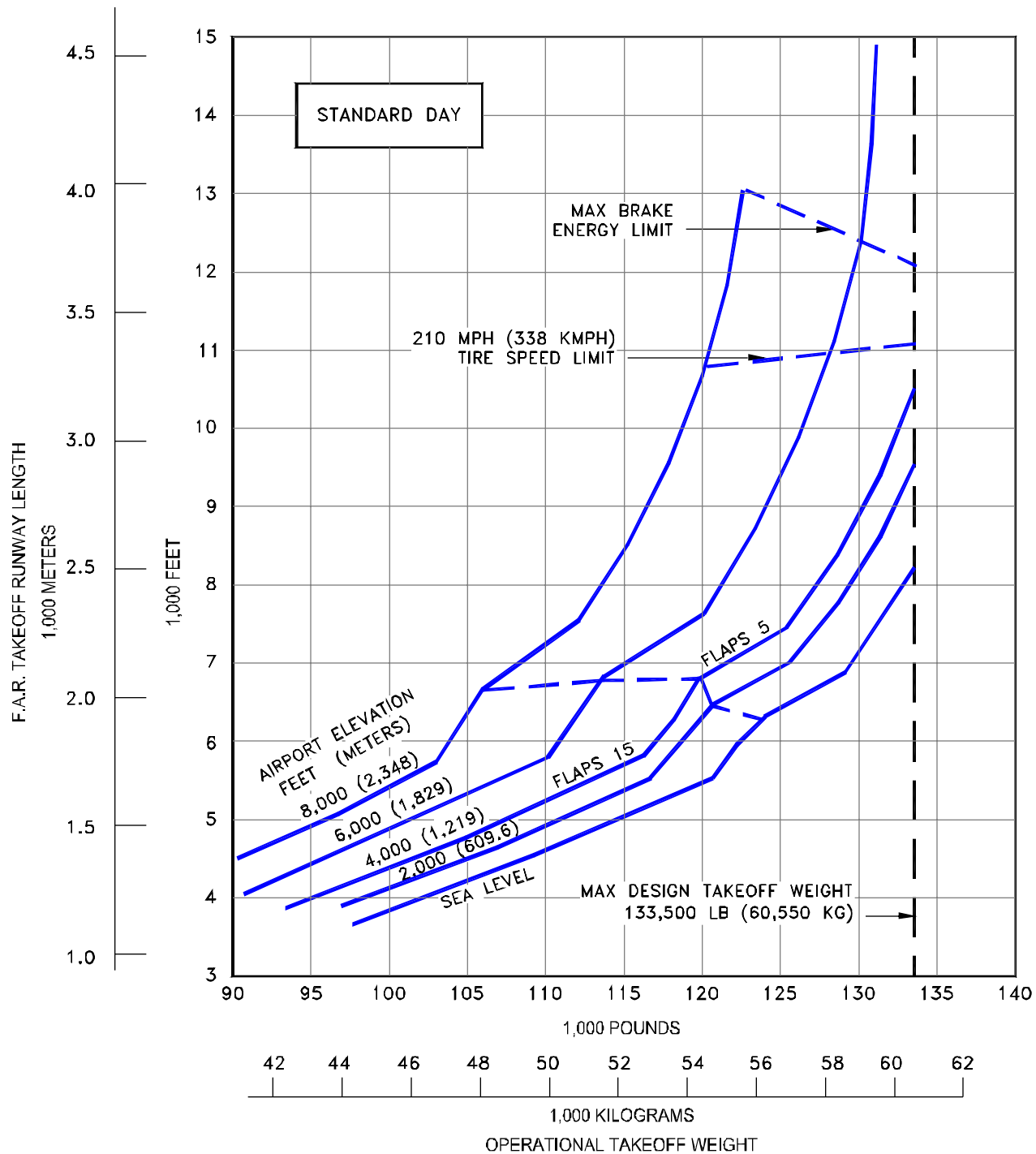

**3.3.19 F.A.R. TAKEOFF RUNWAY LENGTH REQUIREMENTS
STANDARD DAY**

MODEL 737-500 (CFM56-3B-1 ENGINES AT 20,000 LB SLST)

D6-58325-6

NOTES:

- * NO ENGINE AIRBLEED FOR AIR CONDITIONING
- * ZERO WIND, ZERO RUNWAY GRADIENT
- * CONSULT USING AIRLINE FOR SPECIFIC OPERATING PROCEDURE PRIOR TO FACILITY DESIGN
- * CFM 56-3B1 ENGINES RATED AT 20,000 LB SLST

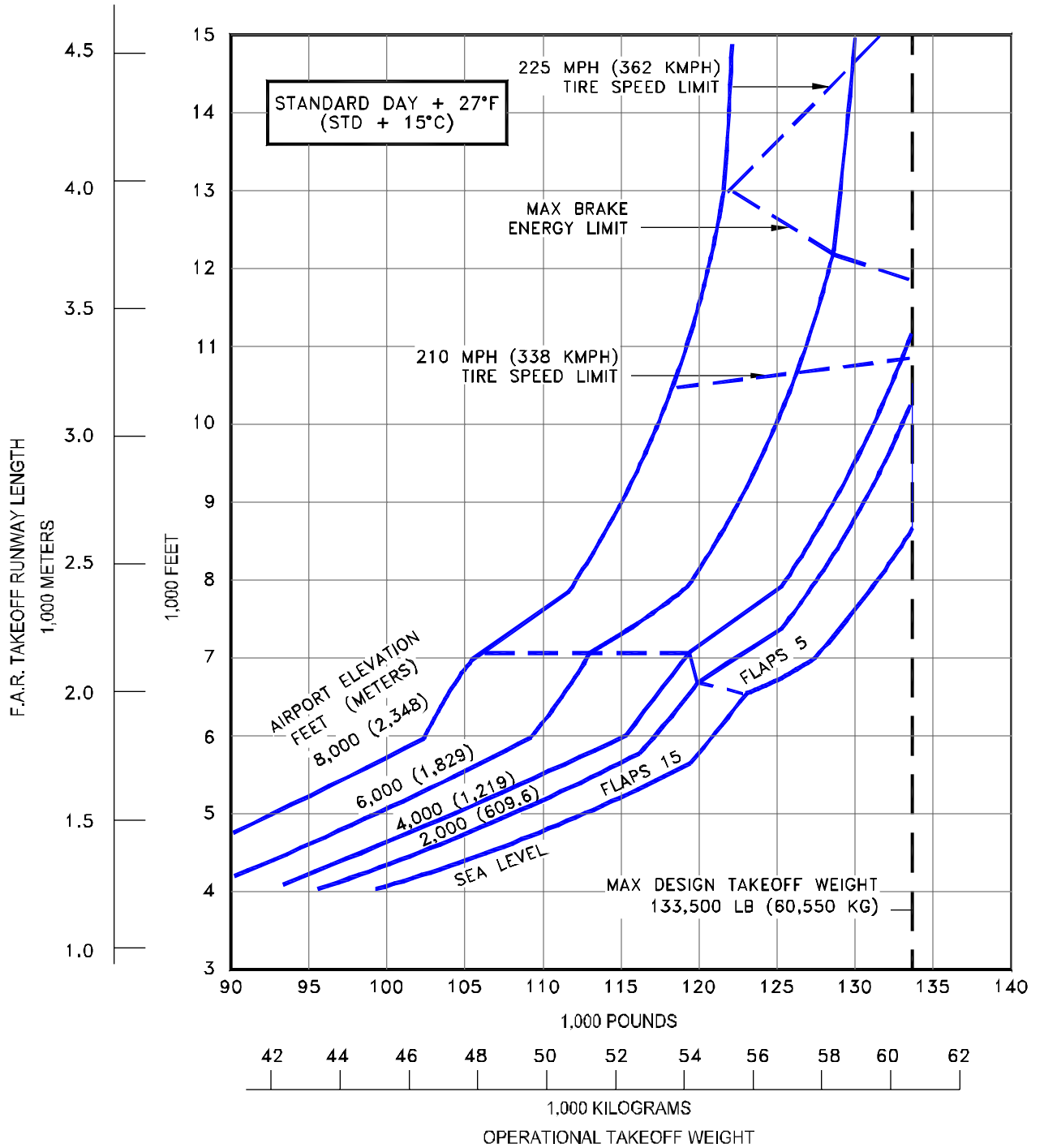

3.3.20 F.A.R. TAKEOFF RUNWAY LENGTH REQUIREMENTS

STANDARD DAY +27°F (STD + 15°C)

MODEL 737-500 (CFM56-3B-1 ENGINES AT 20,000 LB SLST)

NOTES:

- * NO ENGINE AIRBLEED FOR AIR CONDITIONING
- * ZERO WIND, ZERO RUNWAY GRADIENT
- * CONSULT USING AIRLINE FOR SPECIFIC OPERATING PROCEDURE PRIOR TO FACILITY DESIGN
- * CFM 56-3B1 ENGINES RATED AT 18,500 LB SLST

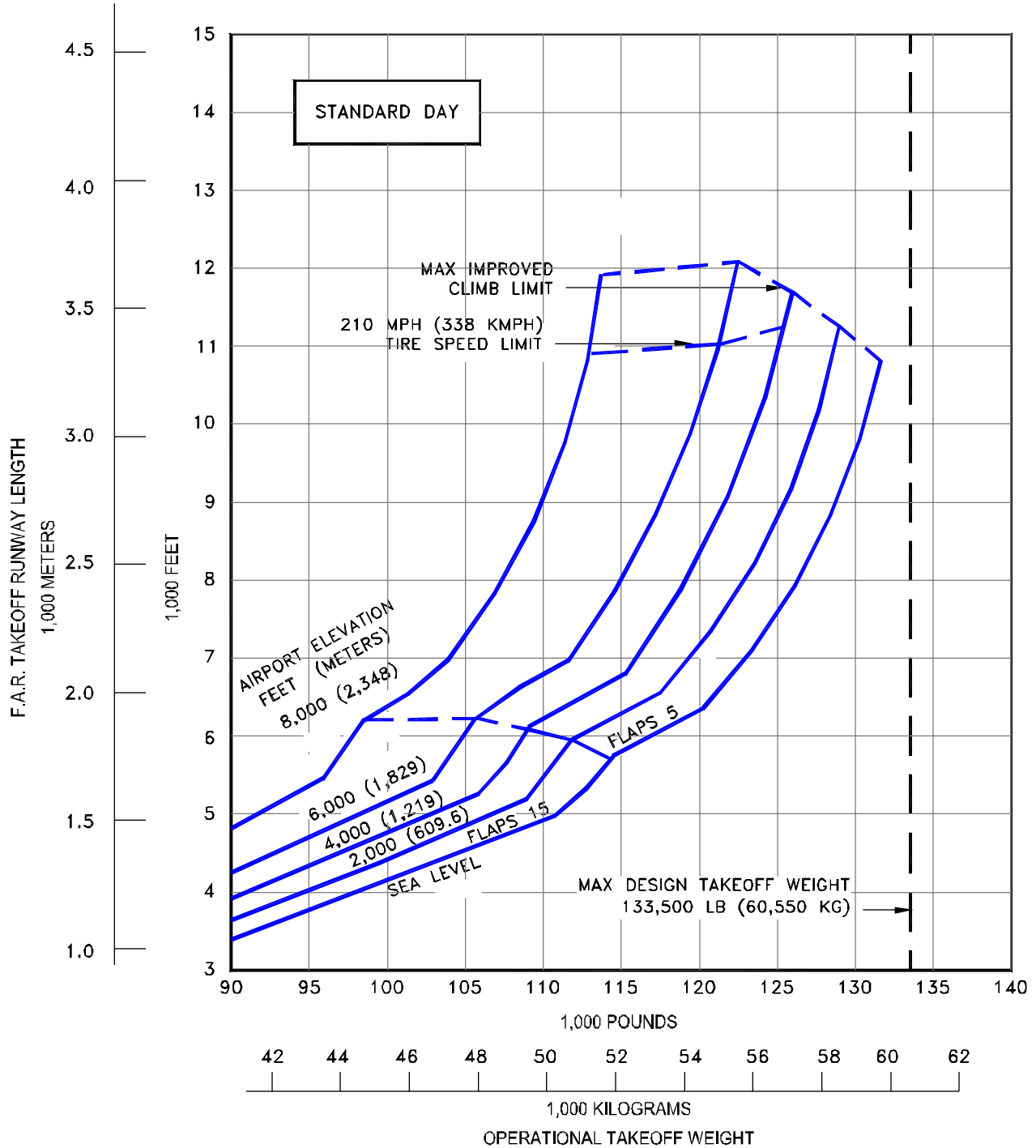

**3.3.21 F.A.R. TAKEOFF RUNWAY LENGTH REQUIREMENTS
STANDARD DAY**

MODEL 737-500 (CFM56-3B-1 ENGINES AT 18,500 LB SLST)

D6-58325-6

NOTES:

- * NO ENGINE AIRBLEED FOR AIR CONDITIONING
- * ZERO WIND, ZERO RUNWAY GRADIENT
- * CONSULT USING AIRLINE FOR SPECIFIC OPERATING PROCEDURE PRIOR TO FACILITY DESIGN
- * CFM 56-3B1 ENGINES RATED AT 18,500 LB SLST

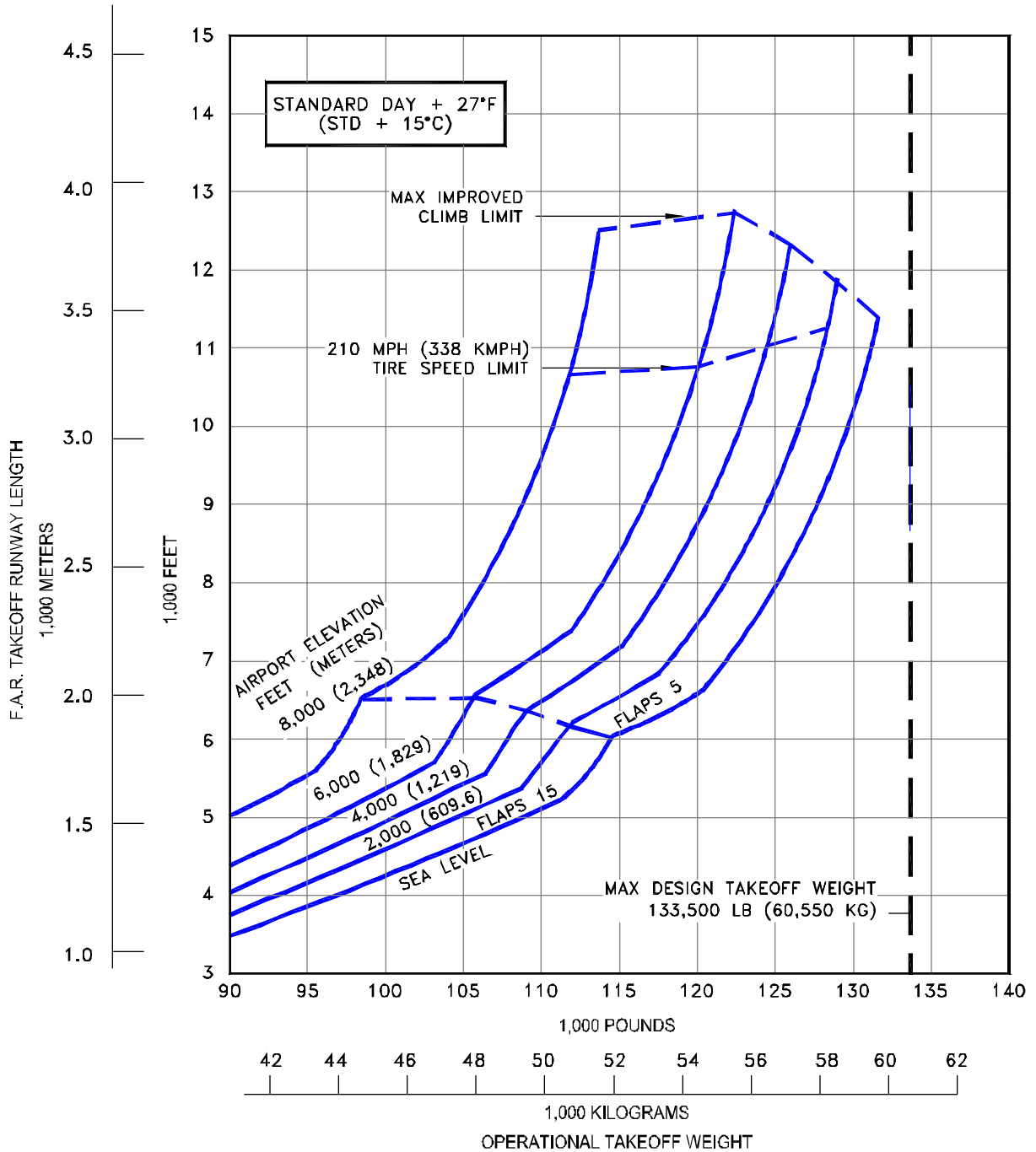

3.3.22 F.A.R. TAKEOFF RUNWAY LENGTH REQUIREMENTS

STANDARD DAY +27°F (STD + 15°C)

MODEL 737-500 (CFM56-3B-1 ENGINES AT 18,500 LB SLST)

NOTES:

- CFM56-7B18 ENGINES AT 19,500 LB SLST
- NO ENGINE BLEED AIR FOR AIR CONDITIONING
- ZERO WIND, ZERO RUNWAY GRADIENT
- DRY RUNWAY SURFACE
- CONSULT WITH USING AIRLINE FOR SPECIFIC OPERATING PROCEDURE PRIOR TO FACILITY DESIGN

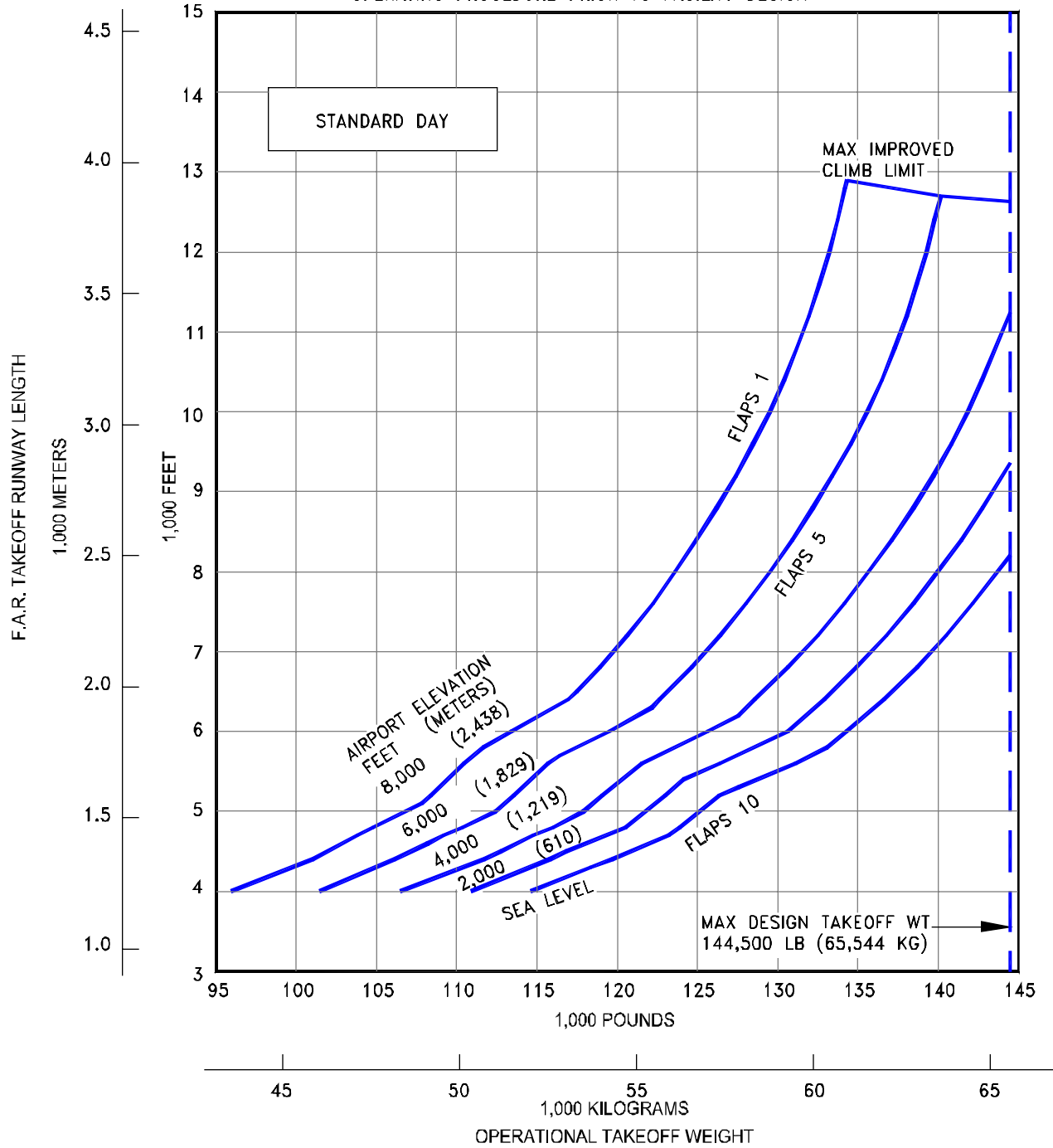

**3.3.23 F.A.R. TAKEOFF RUNWAY LENGTH REQUIREMENTS
STANDARD DAY, DRY RUNWAY**

MODEL 737-600 (CFM56-7B18 ENGINES AT 19,500 LB SLST)

D6-58325-6

NOTES:

- CFM56-7B18 ENGINES AT 19,500 LB SLST
- NO ENGINE AIR BLEED FOR AIR CONDITIONING
- ZERO WIND, ZERO RUNWAY GRADIENT
- DRY RUNWAY SURFACE
- CONSULT WITH USING AIRLINE FOR SPECIFIC OPERATING PROCEDURE PRIOR TO FACILITY DESIGN

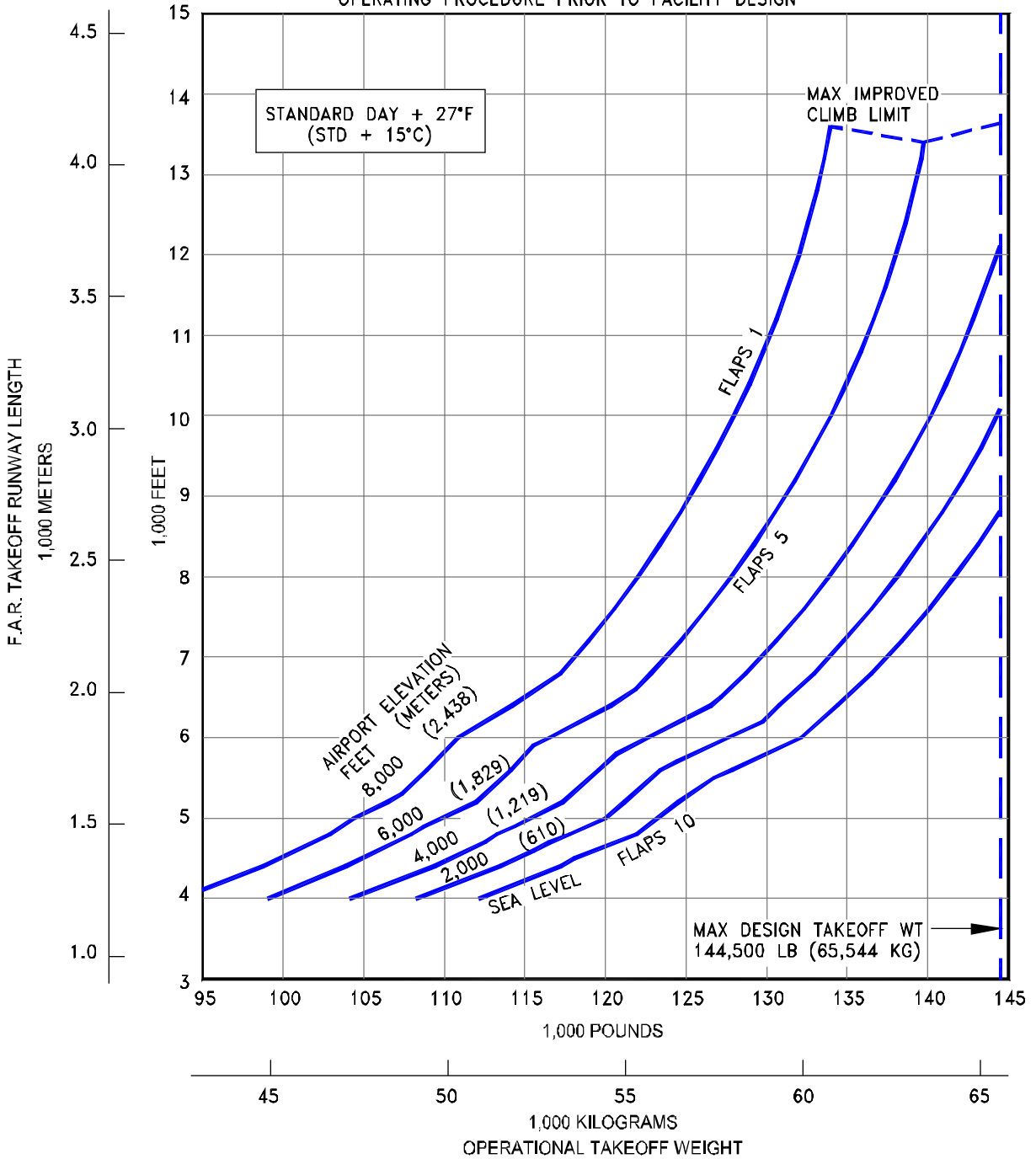

3.3.24 F.A.R. TAKEOFF RUNWAY LENGTH REQUIREMENTS
STANDARD DAY +27°F (STD + 15°C), DRY RUNWAY
MODEL 737-600 (CFM56-7B18 ENGINES AT 19,500 LB SLST)

NOTES:

- CFM56-7B18 ENGINES AT 19,500 LB SLST
- NO ENGINE BLEED AIR FOR AIR CONDITIONING
- ZERO WIND, ZERO RUNWAY GRADIENT
- WET SMOOTH RUNWAY SURFACE
- CONSULT WITH USING AIRLINE FOR SPECIFIC OPERATING PROCEDURE PRIOR TO FACILITY DESIGN
- TAKEOFF PERFORMANCE IMPROVEMENTS ARE POSSIBLE USING GROOVED RUNWAY

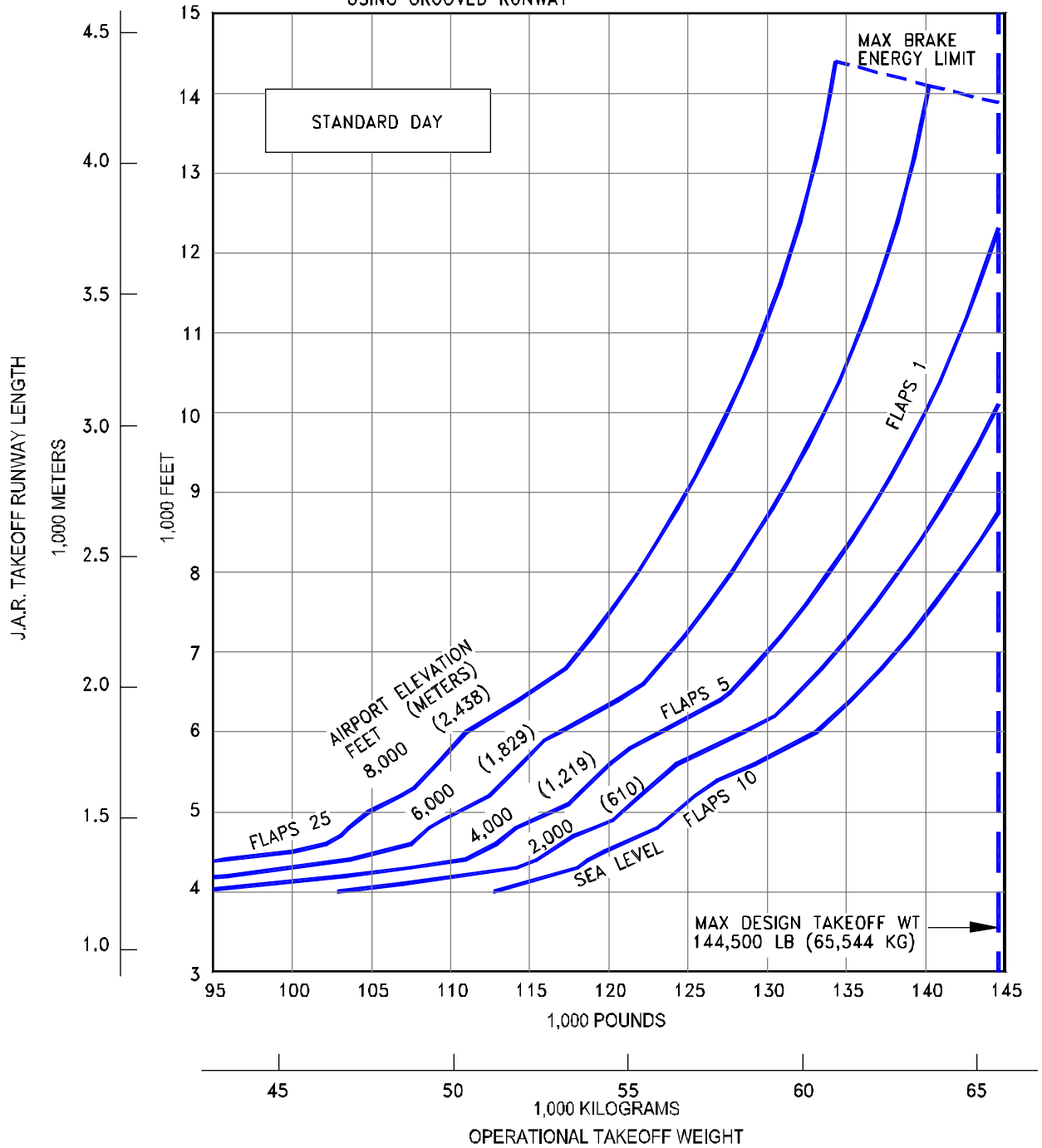

3.3.25 J.A.R. TAKEOFF RUNWAY LENGTH REQUIREMENTS
STANDARD DAY, WET RUNWAY
MODEL 737-600 (CFM56-7B18 ENGINES AT 19,500 LB SLST)

- NOTES:
- CFM56-7B18 ENGINES AT 19,500 LB SLST
 - NO ENGINE AIR BLEED FOR AIR CONDITIONING
 - ZERO WIND, ZERO RUNWAY GRADIENT
 - WET SMOOTH RUNWAY SURFACE
 - CONSULT WITH USING AIRLINE FOR SPECIFIC OPERATING PROCEDURE PRIOR TO FACILITY DESIGN
 - TAKEOFF PERFORMANCE IMPROVEMENTS ARE POSSIBLE USING GROOVED RUNWAY

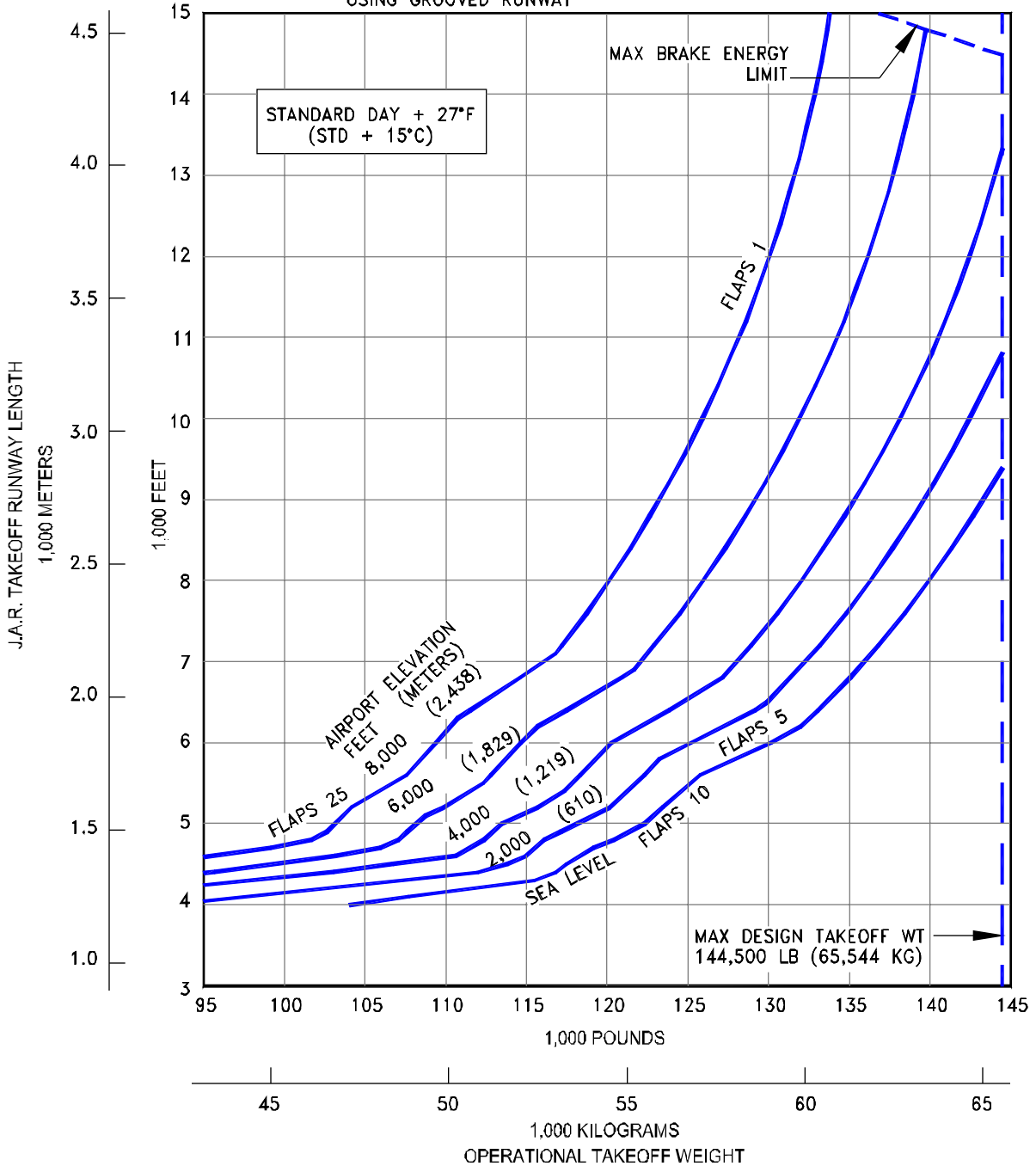

3.3.26 J.A.R. TAKEOFF RUNWAY LENGTH REQUIREMENTS
STANDARD DAY +27°F (STD + 15°C), WET RUNWAY
MODEL 737-600 (CFM56-7B18 ENGINES AT 19,500 LB SLST)

NOTES:

- CFM56-7B20 ENGINES RATED AT 20,600 LB SLST
- NO ENGINE AIR BLEED FOR AIR CONDITIONING
- ZERO WIND, ZERO RUNWAY GRADIENT
- DRY RUNWAY SURFACE
- CONSULT WITH USING AIRLINE FOR SPECIFIC OPERATING PROCEDURE PRIOR TO FACILITY DESIGN

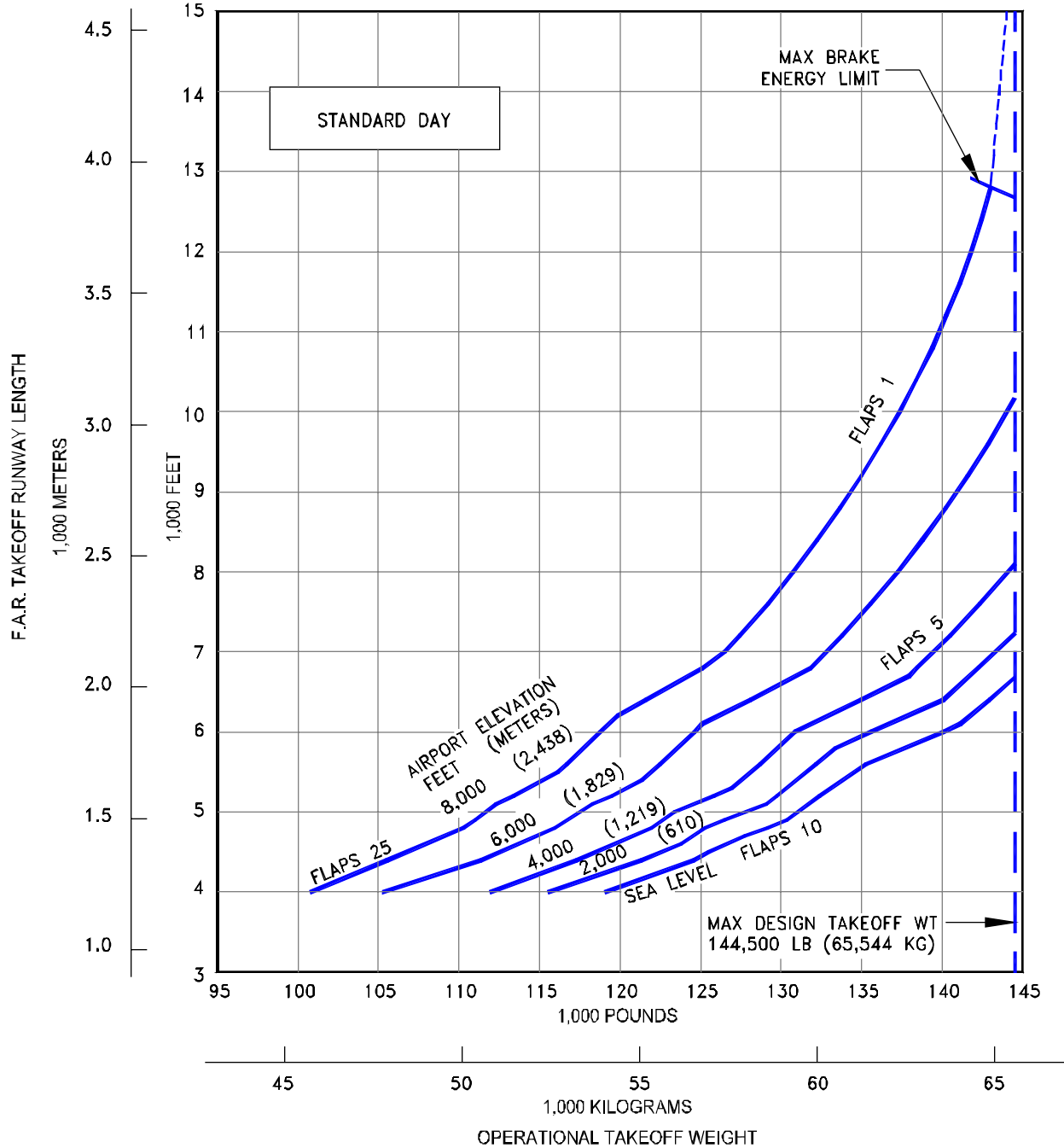

3.3.27 F.A.R. TAKEOFF RUNWAY LENGTH REQUIREMENTS
STANDARD DAY, DRY RUNWAY
MODEL 737-600 (CFM56-7B20 ENGINES AT 20,600 LB SLST)

D6-58325-6

NOTES:

- CFM56-7B20 ENGINES RATED AT 20,600 LB SLST
- NO ENGINE AIR BLEED FOR AIR CONDITIONING
- ZERO WIND, ZERO RUNWAY GRADIENT
- DRY RUNWAY SURFACE
- CONSULT WITH USING AIRLINE FOR SPECIFIC OPERATING PROCEDURE PRIOR TO FACILITY DESIGN

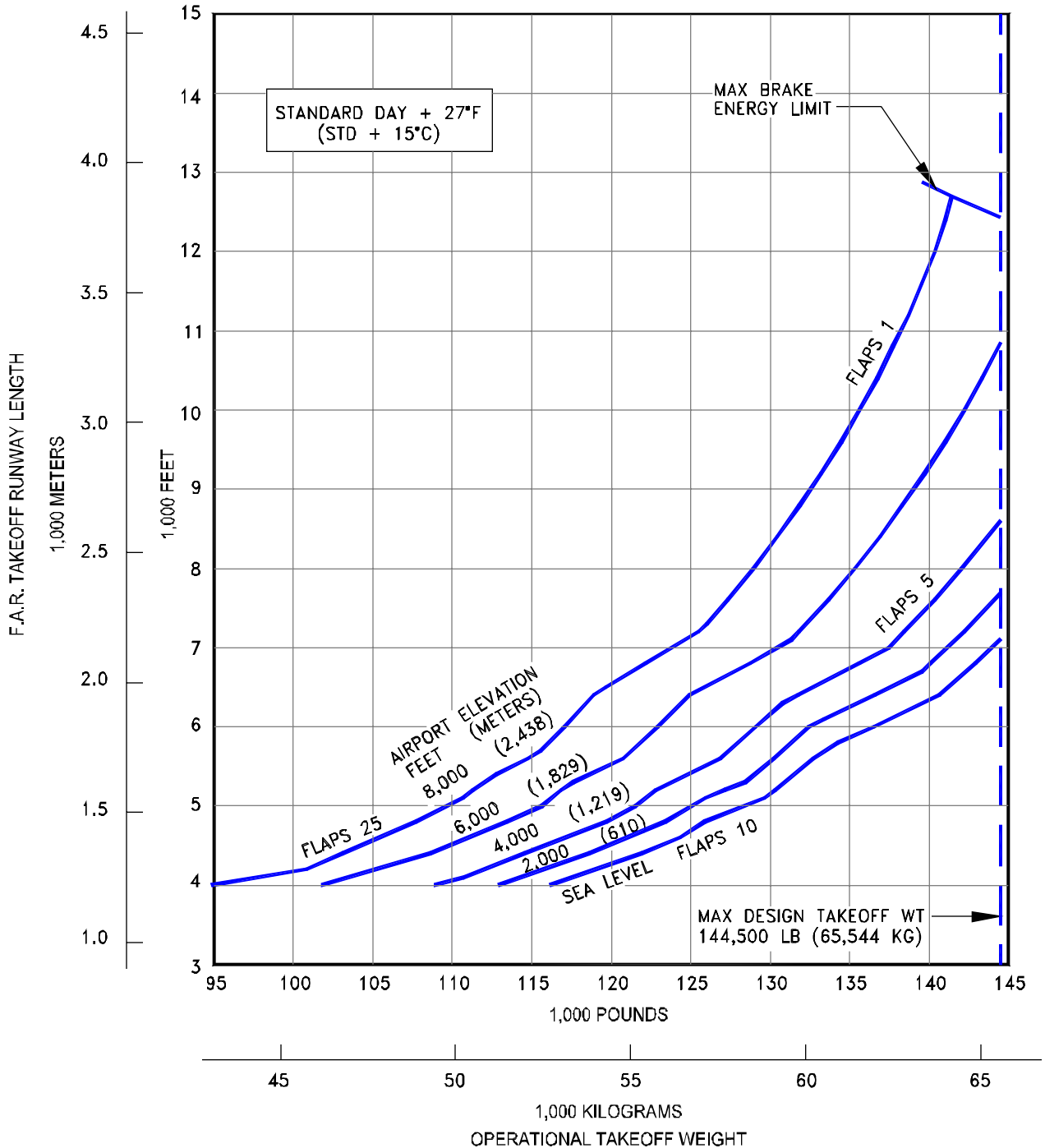

3.3.28 F.A.R. TAKEOFF RUNWAY LENGTH REQUIREMENTS
STANDARD DAY +27°F (STD + 15°C), DRY RUNWAY
MODEL 737-600 (CFM56-7B20 ENGINES AT 20,600 LB SLST)

NOTES:

- CFM56-7B20 ENGINES RATED AT 20,600 LB SLST
- NO ENGINE AIR BLEED FOR AIR CONDITIONING
- ZERO WIND, ZERO RUNWAY GRADIENT
- WET SMOOTH RUNWAY SURFACE
- CONSULT WITH USING AIRLINE FOR SPECIFIC OPERATING PROCEDURE PRIOR TO FACILITY DESIGN
- TAKEOFF PERFORMANCE IMPROVEMENTS ARE POSSIBLE USING GROOVED RUNWAY

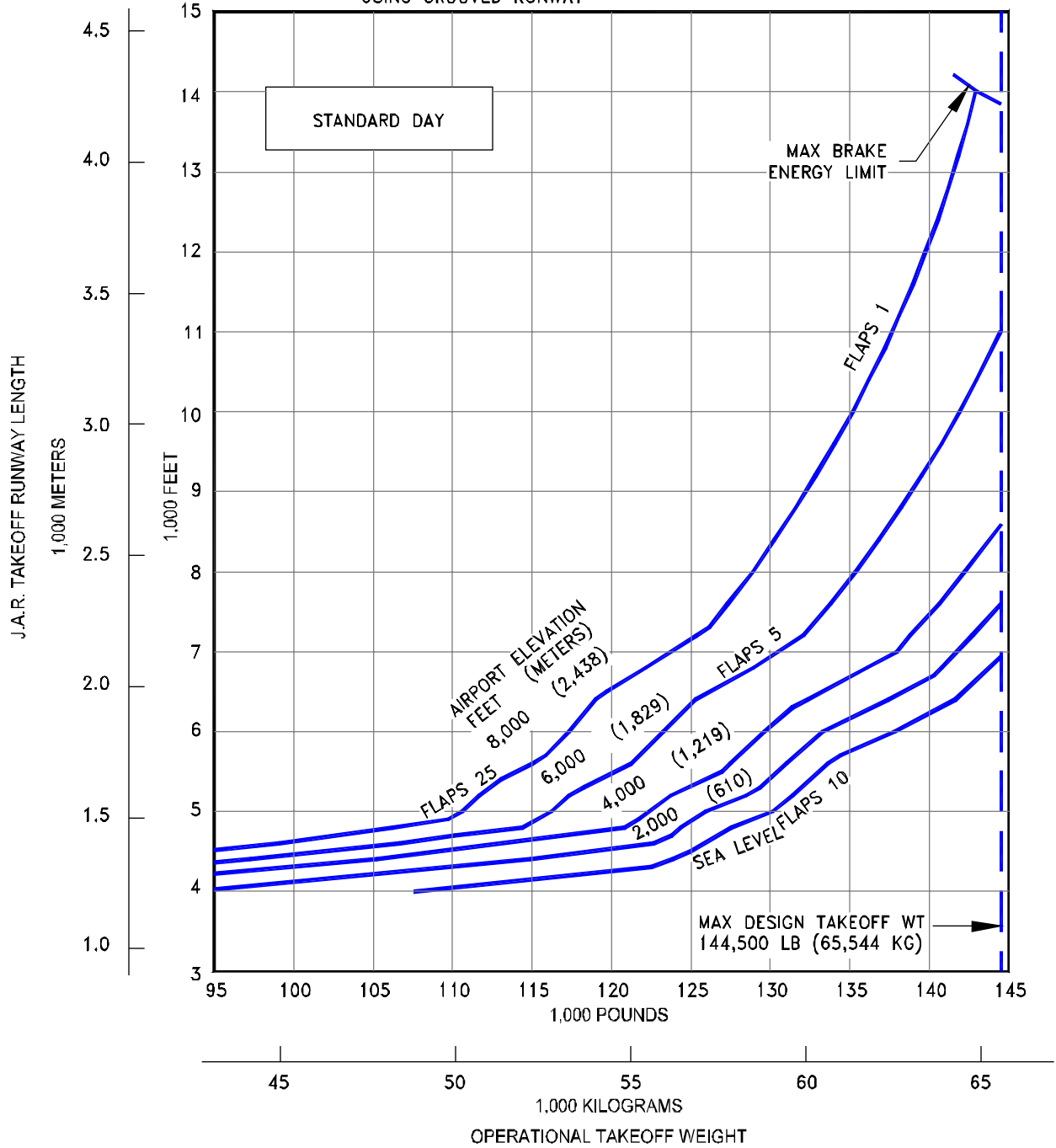

**3.3.29 J.A.R. TAKEOFF RUNWAY LENGTH REQUIREMENTS
STANDARD DAY, WET RUNWAY
MODEL 737-600 (CFM56-7B20 ENGINES AT 20,000 LB SLST)**

NOTES:

- CFM56-7B20 ENGINES RATED AT 20,600 LB SLST
- NO ENGINE AIR BLEED FOR AIR CONDITIONING
- ZERO WIND, ZERO RUNWAY GRADIENT
- WET SMOOTH RUNWAY SURFACE
- CONSULT WITH USING AIRLINE FOR SPECIFIC OPERATING PROCEDURE PRIOR TO FACILITY DESIGN
- TAKEOFF PERFORMANCE IMPROVEMENTS ARE POSSIBLE USING GROOVED RUNWAY

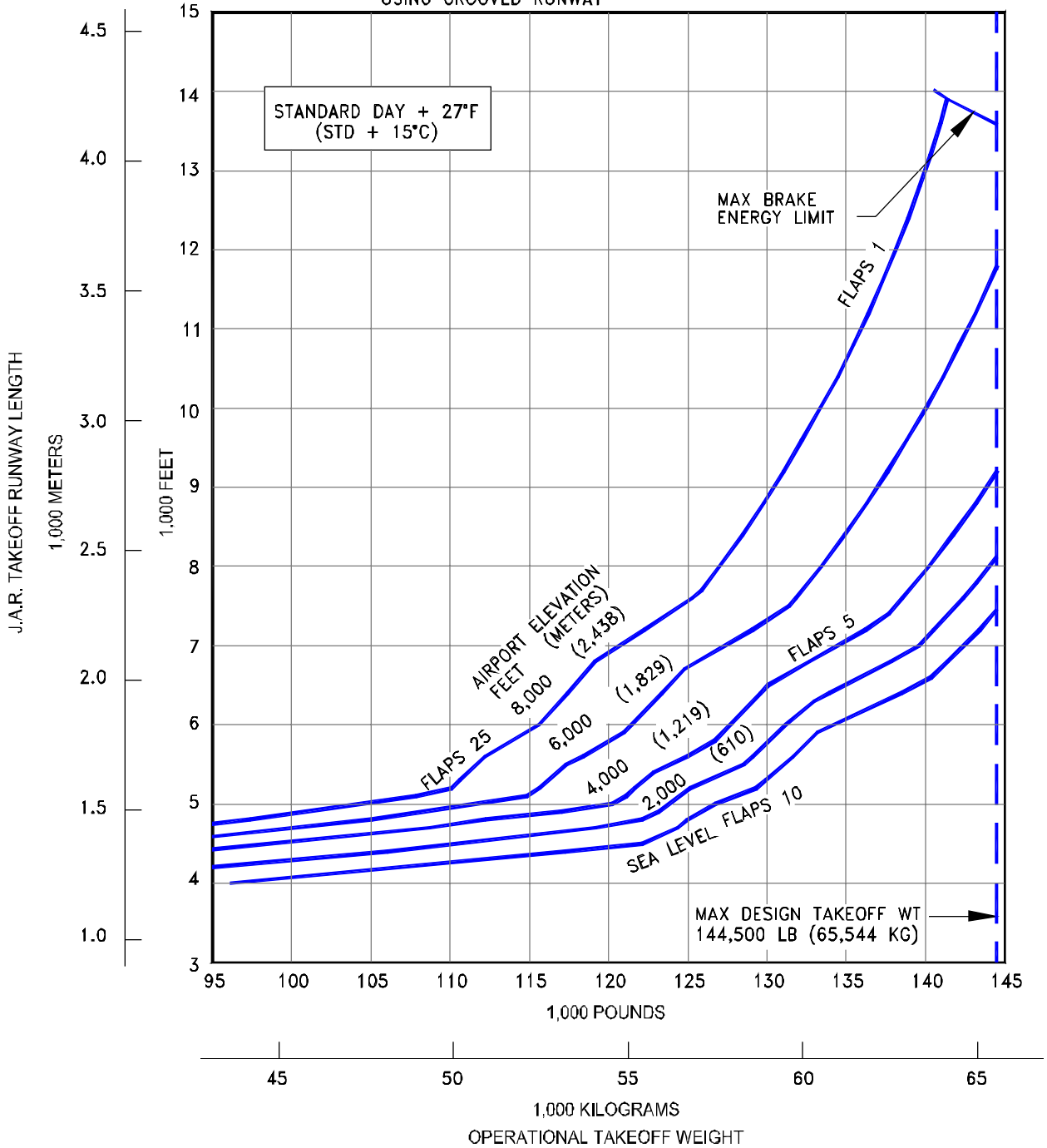

3.3.30 J.A.R. TAKEOFF RUNWAY LENGTH REQUIREMENTS
STANDARD DAY +27°F (STD + 15°C), WET RUNWAY
MODEL 737-600 (CFM56-7B20 ENGINES AT 20,600 LB SLST)

NOTES:

- CFM56-7B22 ENGINES RATED AT 22,700 LB SLST
- NO ENGINE AIR BLEED FOR AIR CONDITIONING
- ZERO WIND, ZERO RUNWAY GRADIENT
- DRY RUNWAY SURFACE
- CONSULT WITH USING AIRLINE FOR SPECIFIC OPERATING PROCEDURE PRIOR TO FACILITY DESIGN

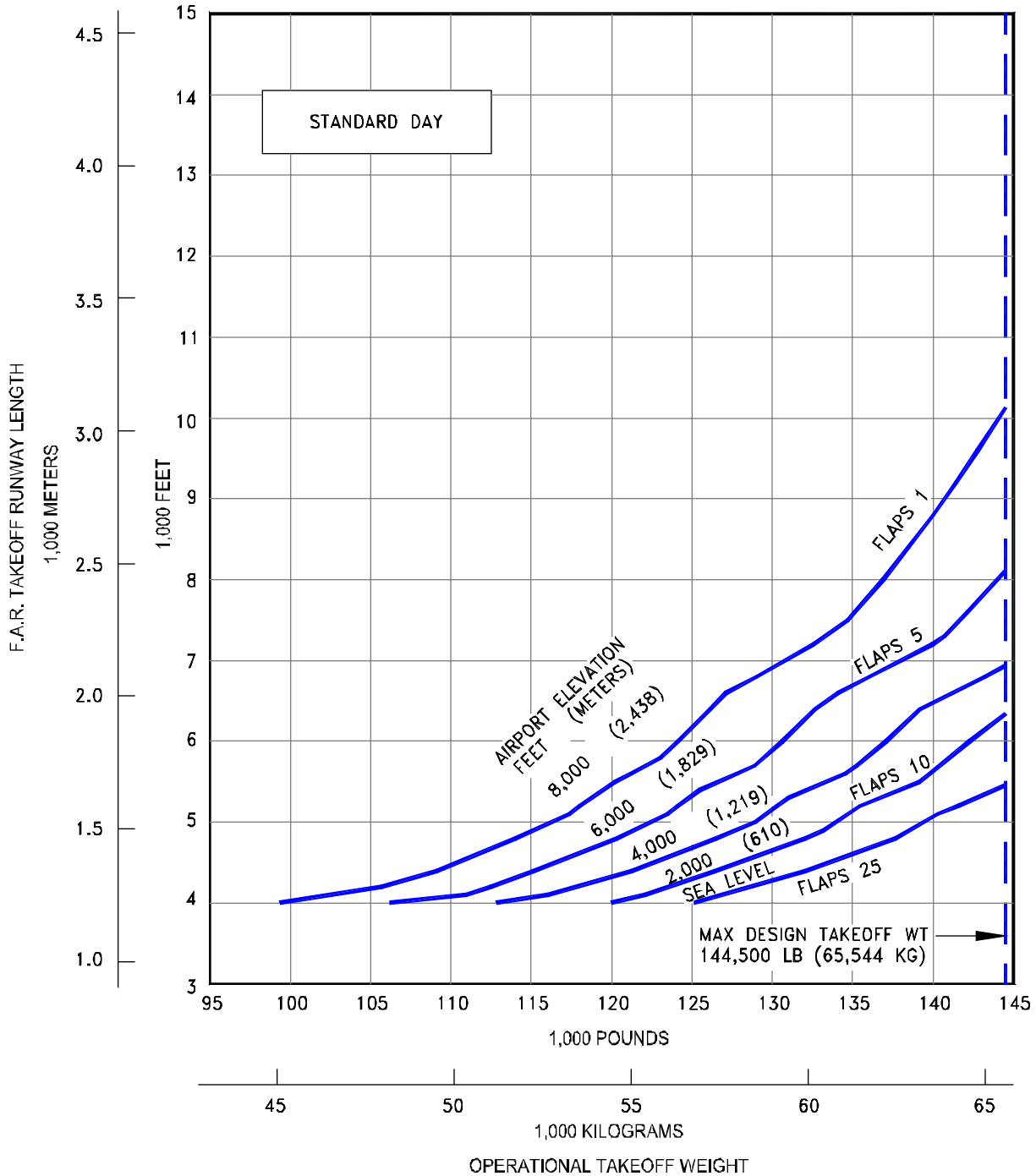

**3.3.31 F.A.R. TAKEOFF RUNWAY LENGTH REQUIREMENTS
STANDARD DAY, DRY RUNWAY
MODEL 737-600 (CFM56-7B22 ENGINES AT 22,700 LB SLST)**

NOTES:

- CFM56-7B22 ENGINES RATED AT 22,700 LB SLST
- NO ENGINE AIR BLEED FOR AIR CONDITIONING
- ZERO WIND, ZERO RUNWAY GRADIENT
- DRY RUNWAY SURFACE
- CONSULT WITH USING AIRLINE FOR SPECIFIC OPERATING PROCEDURE PRIOR TO FACILITY DESIGN

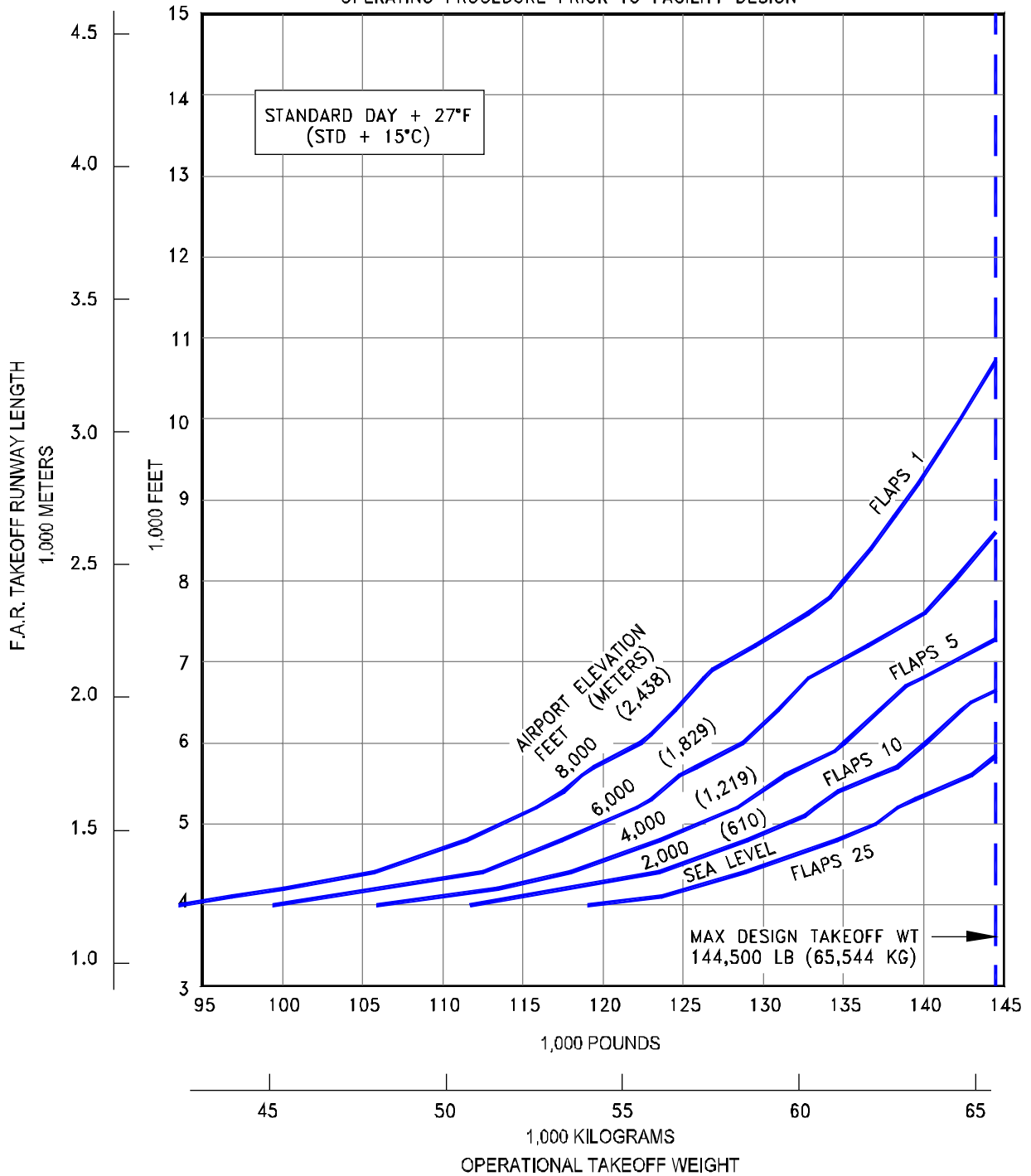

3.3.32 F.A.R. TAKEOFF RUNWAY LENGTH REQUIREMENTS
STANDARD DAY +27°F (STD + 15°C), DRY RUNWAY
MODEL 737-600 (CFM56-7B22 ENGINES AT 22,700 LB SLST)

NOTES:

- CFM56-7B22 ENGINES RATED AT 22,700 LB SLST
- NO ENGINE AIR BLEED FOR AIR CONDITIONING
- ZERO WIND, ZERO RUNWAY GRADIENT
- WET SMOOTH RUNWAY SURFACE
- CONSULT WITH USING AIRLINE FOR SPECIFIC OPERATING PROCEDURE PRIOR TO FACILITY DESIGN
- TAKEOFF PERFORMANCE IMPROVEMENTS ARE POSSIBLE USING GROOVED RUNWAY

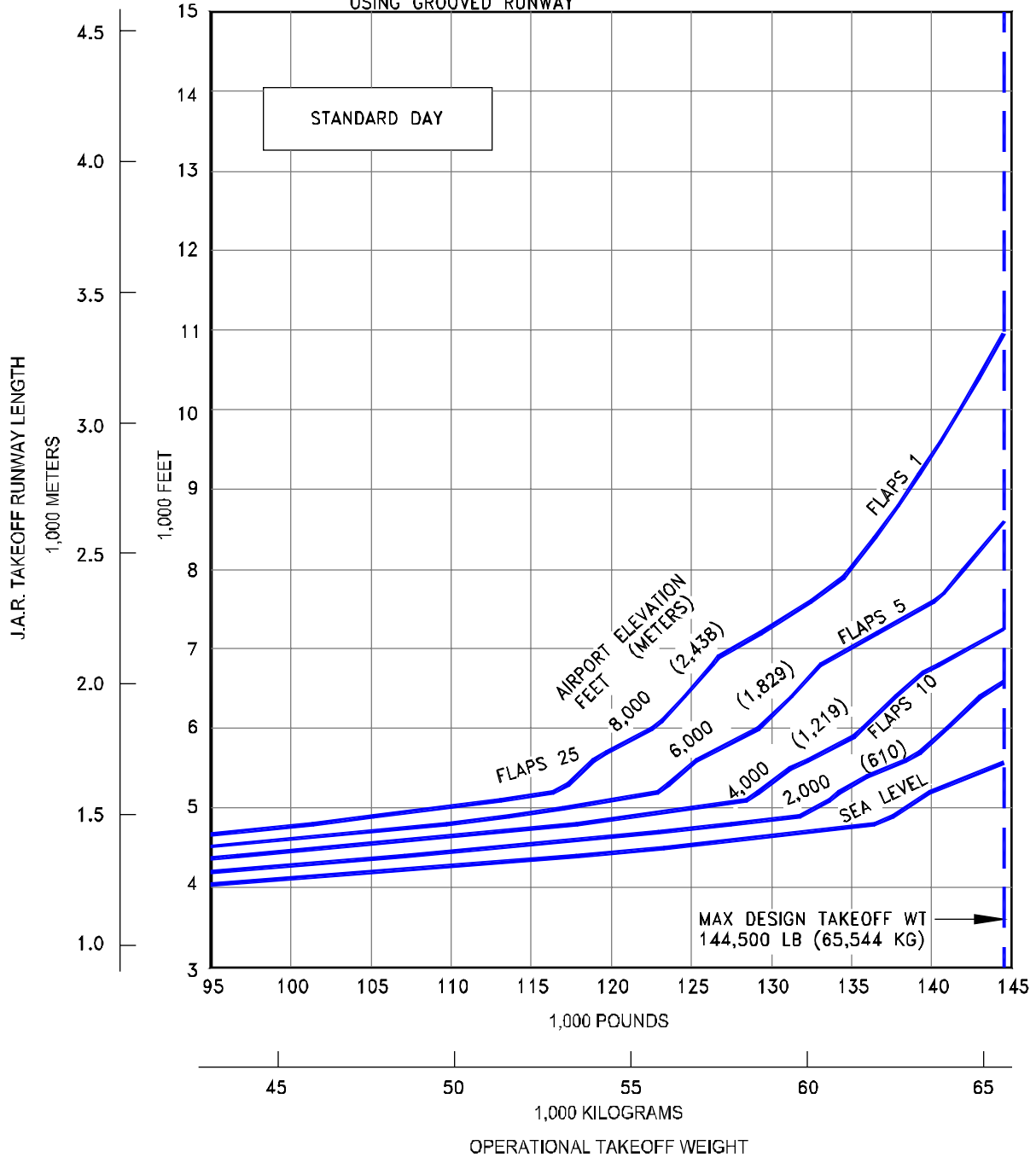

**3.3.33 J.A.R. TAKEOFF RUNWAY LENGTH REQUIREMENTS
STANDARD DAY, WET RUNWAY
MODEL 737-600 (CFM56-7B22 ENGINES AT 22,700 LB SLST)**

NOTES:

- CFM56-7B22 ENGINES RATED AT 22,700 LB SLST
- NO ENGINE AIR BLEED FOR AIR CONDITIONING
- ZERO WIND, ZERO RUNWAY GRADIENT
- WET SMOOTH RUNWAY SURFACE
- CONSULT WITH USING AIRLINE FOR SPECIFIC OPERATING PROCEDURE PRIOR TO FACILITY DESIGN
- TAKEOFF PERFORMANCE IMPROVEMENTS ARE POSSIBLE USING GROOVED RUNWAY

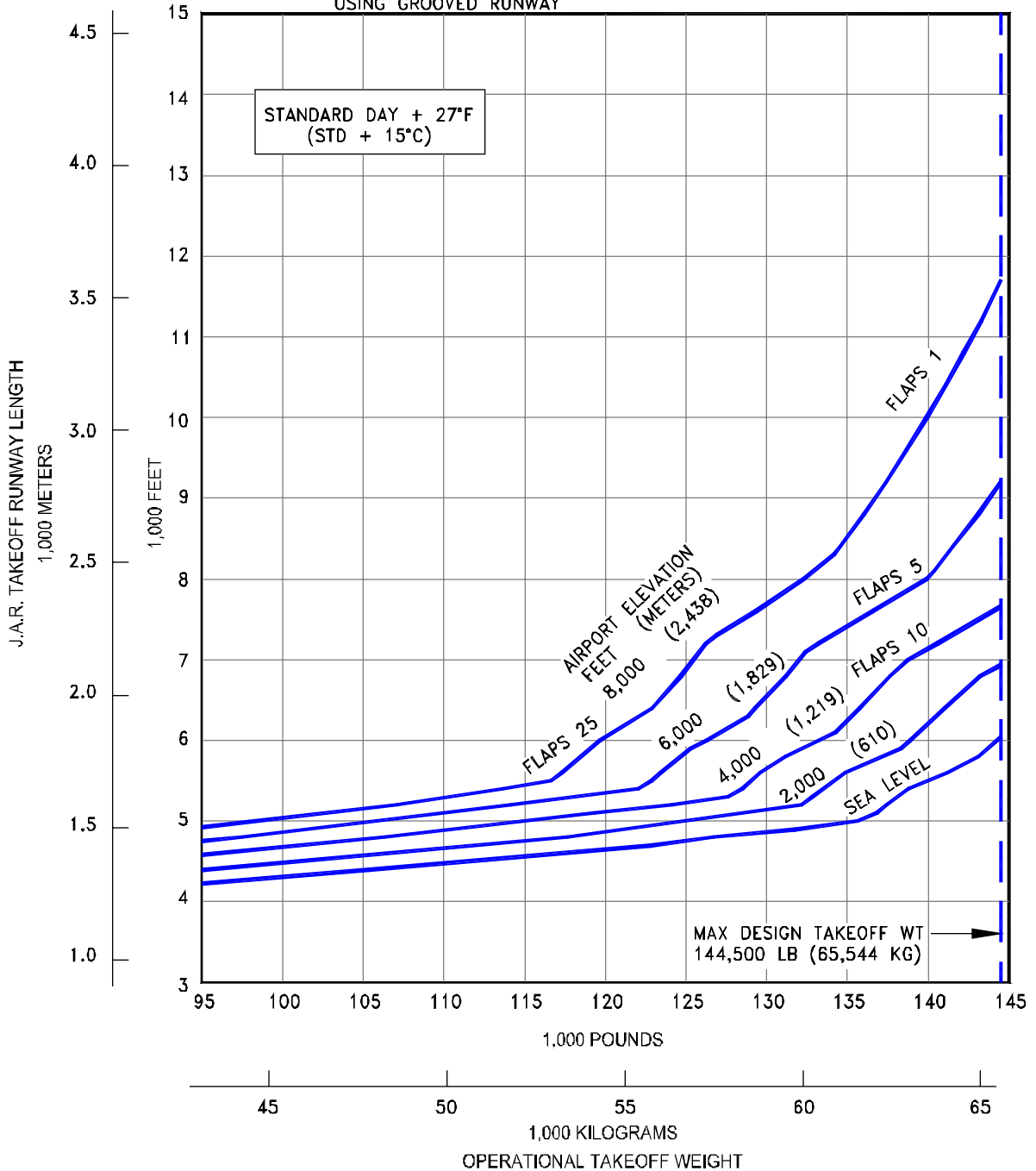

3.3.34 J.A.R. TAKEOFF RUNWAY LENGTH REQUIREMENTS
STANDARD DAY +27°F (STD + 15°C), WET RUNWAY
MODEL 737-600 (CFM56-7B22 ENGINES AT 22,700 LB SLST)

NOTES:

- CFM56-7B20 ENGINES RATED AT 20,600 LB SLST
- NO ENGINE AIR BLEED FOR AIR CONDITIONING
- ZERO WIND, ZERO RUNWAY GRADIENT
- DRY RUNWAY SURFACE
- CONSULT WITH USING AIRLINE FOR SPECIFIC OPERATING PROCEDURE PRIOR TO FACILITY DESIGN

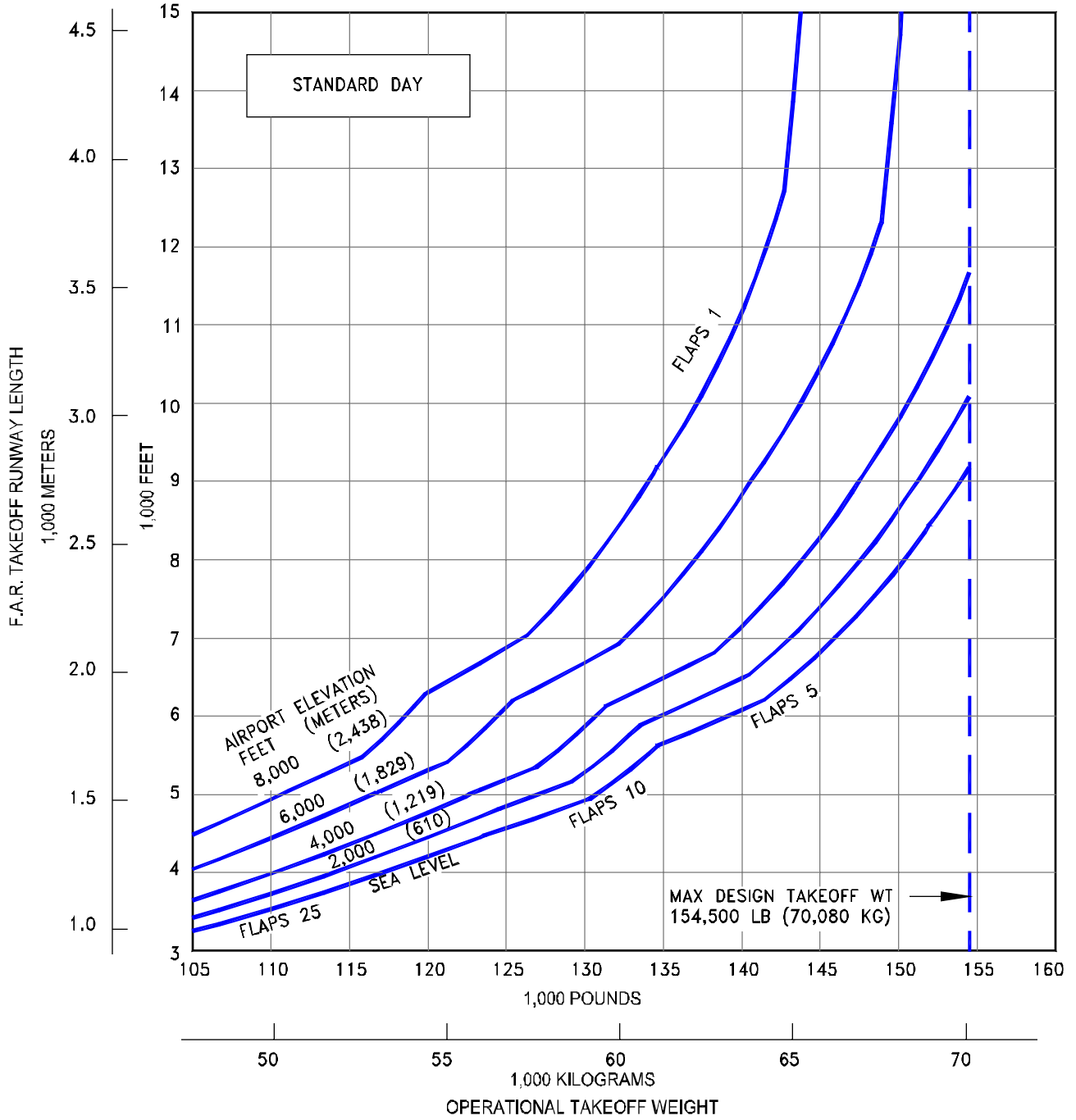

**3.3.35 F.A.R. TAKEOFF RUNWAY LENGTH REQUIREMENTS
STANDARD DAY, DRY RUNWAY**

MODEL 737-700 (CFM56-7B20 ENGINES AT 20,600 LB SLST)

D6-58325-6

NOTES:

- CFM56-7B20 ENGINES RATED AT 20,600 LB SLST
- NO ENGINE AIR BLEED FOR AIR CONDITIONING
- ZERO WIND, ZERO RUNWAY GRADIENT
- DRY RUNWAY SURFACE
- CONSULT WITH USING AIRLINE FOR SPECIFIC OPERATING PROCEDURE PRIOR TO FACILITY DESIGN

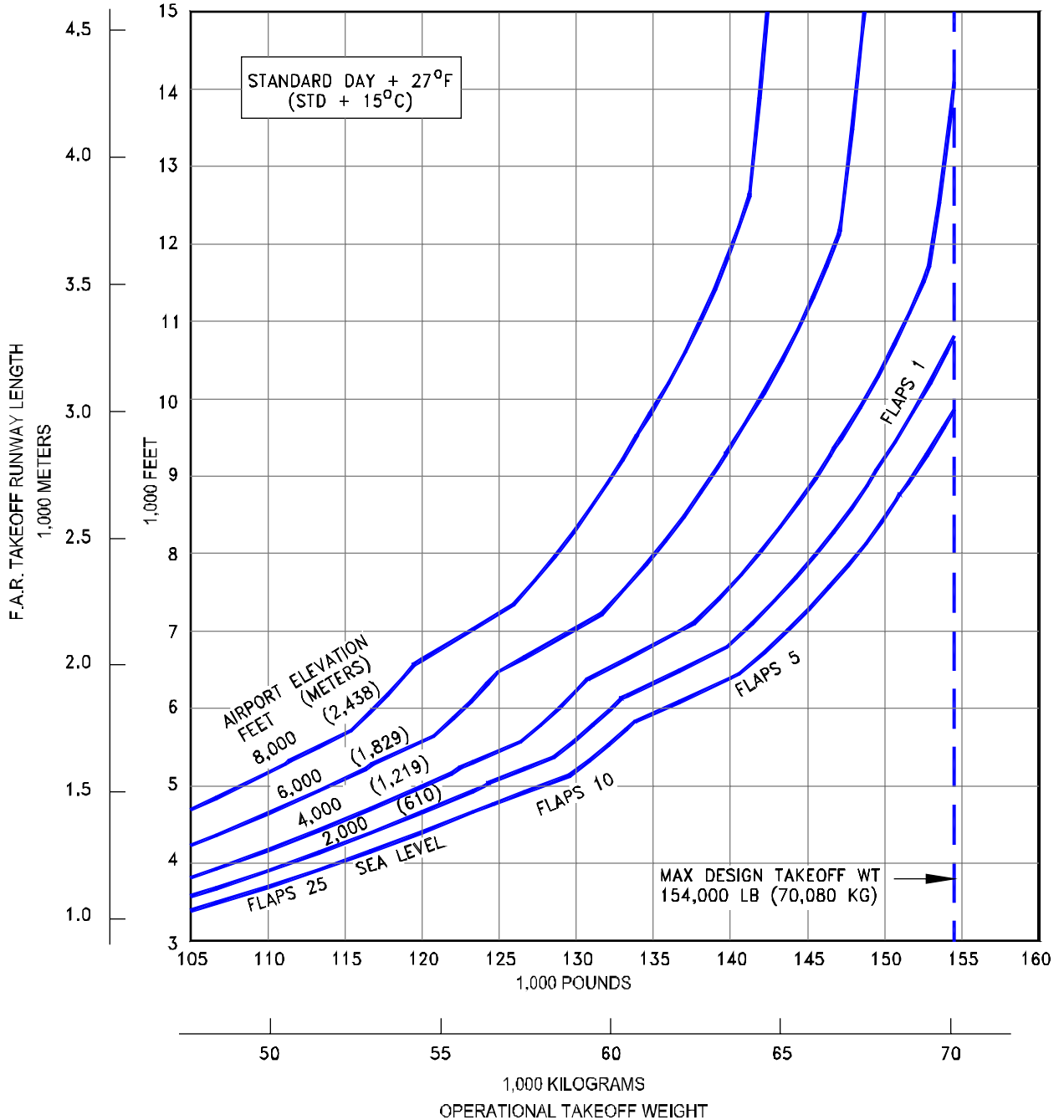

3.3.36 F.A.R. TAKEOFF RUNWAY LENGTH REQUIREMENTS
STANDARD DAY +27°F (STD + 15°C), DRY RUNWAY
MODEL 737-700 (CFM56-7B20 ENGINES AT 20,600 LB SLST)

NOTES:

- CFM56-7B20 ENGINES RATED AT 20,600 LB SLST
- NO ENGINE AIR BLEED FOR AIR CONDITIONING
- ZERO WIND, ZERO RUNWAY GRADIENT
- WET SMOOTH RUNWAY SURFACE
- CONSULT WITH USING AIRLINE FOR SPECIFIC OPERATING PROCEDURE PRIOR TO FACILITY DESIGN
- TAKEOFF PERFORMANCE IMPROVEMENTS ARE POSSIBLE USING GROOVED RUNWAY

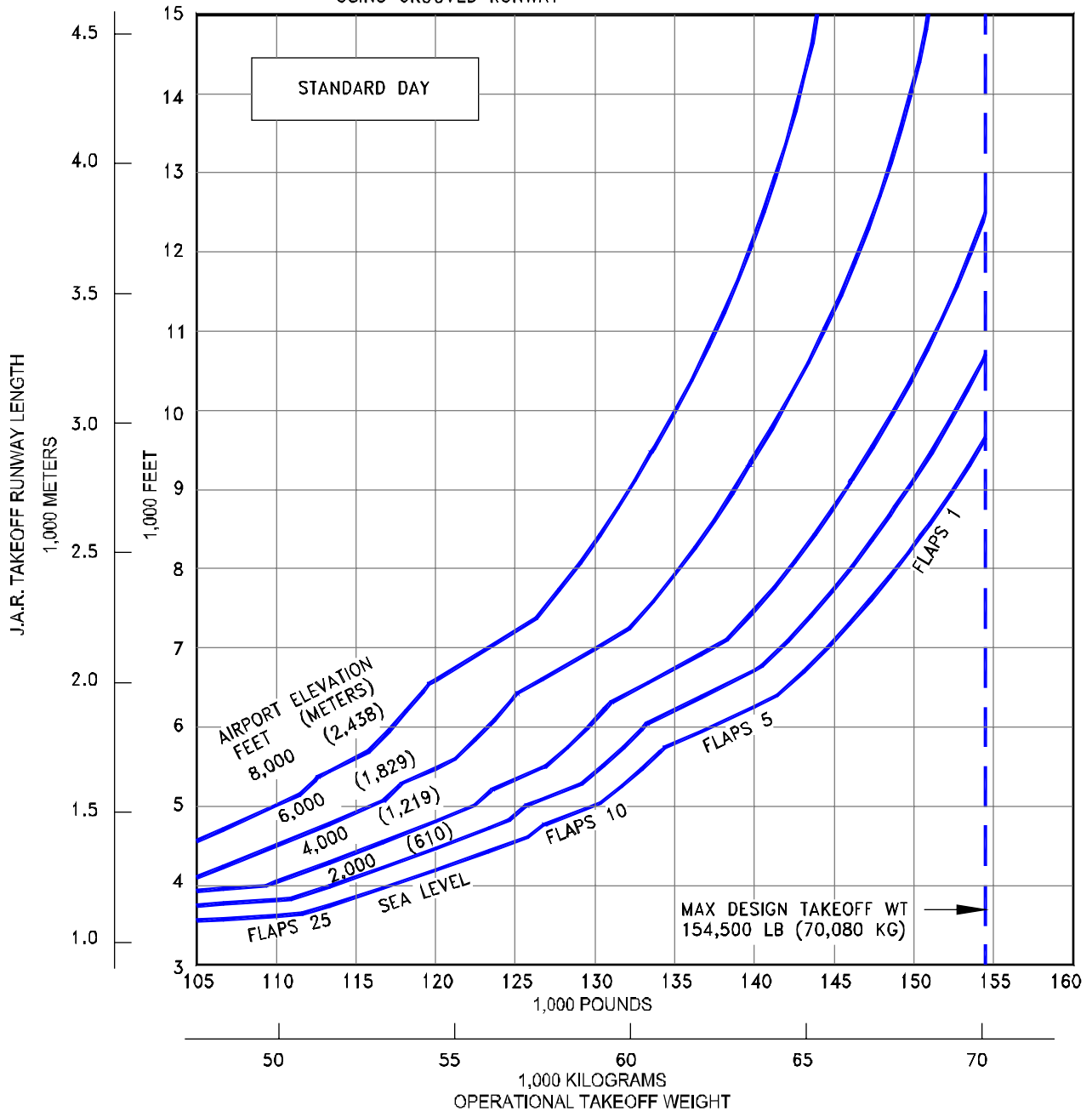

**3.3.37 J.A.R. TAKEOFF RUNWAY LENGTH REQUIREMENTS
STANDARD DAY, WET RUNWAY**

MODEL 737-700 (CFM56-7B20 ENGINES AT 20,600 LB SLST)

D6-58325-6

NOTES:

- CFM56-7B20 ENGINES RATED AT 20,600 LB SLST
- NO ENGINE AIR BLEED FOR AIR CONDITIONING
- ZERO WIND, ZERO RUNWAY GRADIENT
- WET SMOOTH RUNWAY SURFACE
- CONSULT WITH USING AIRLINE FOR SPECIFIC OPERATING PROCEDURE PRIOR TO FACILITY DESIGN
- TAKEOFF PERFORMANCE IMPROVEMENTS ARE POSSIBLE USING GROOVED RUNWAY

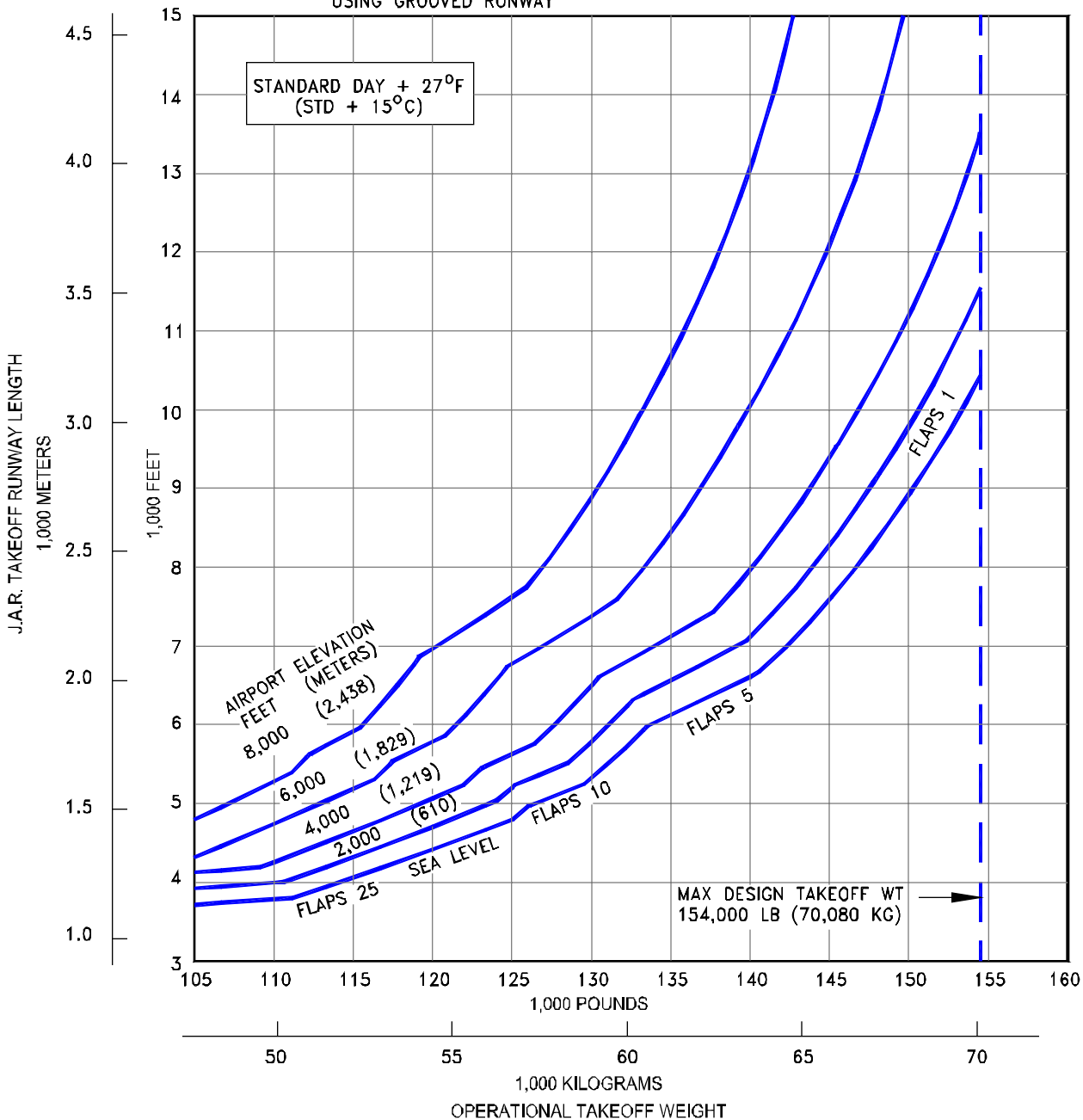

3.3.38 J.A.R. TAKEOFF RUNWAY LENGTH REQUIREMENTS
STANDARD DAY +27°F (STD + 15°C), WET RUNWAY
MODEL 737-700 (CFM56-7B20 ENGINES AT 20,600 LB SLST)

NOTES:

- CFM56-7B20 ENGINES RATED AT 20,600 LB SLST
- NO ENGINE AIR BLEED FOR AIR CONDITIONING
- ZERO WIND, ZERO RUNWAY GRADIENT
- DRY RUNWAY SURFACE
- CONSULT WITH USING AIRLINE FOR SPECIFIC OPERATING PROCEDURE PRIOR TO FACILITY DESIGN

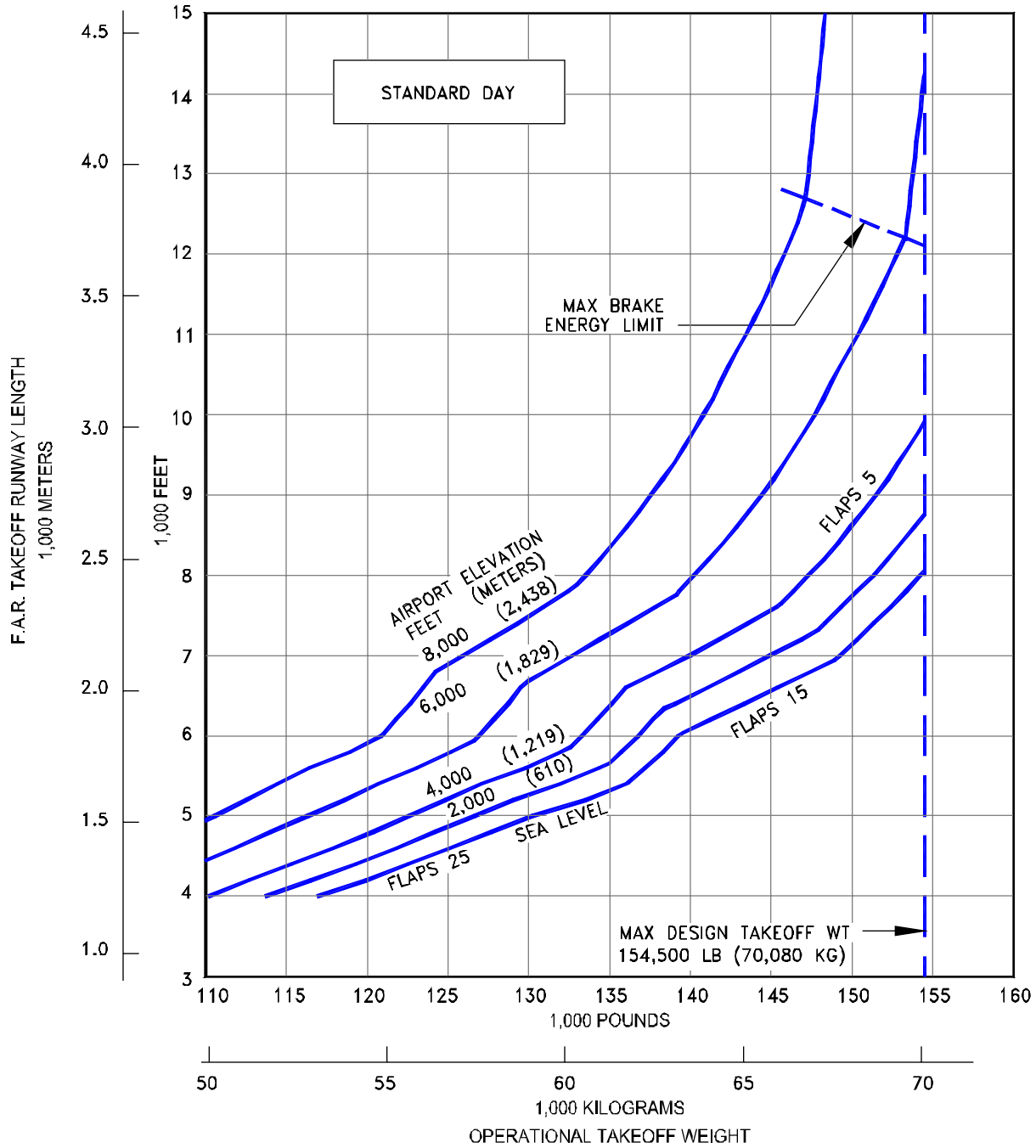

**3.3.39 F.A.R. TAKEOFF RUNWAY LENGTH REQUIREMENTS
STANDARD DAY, DRY RUNWAY**

MODEL 737-700 WITH WINGLETS, (CFM56-7B20 ENGINES AT 20,600 LB SLST)

NOTES:

- CFM56-7B20 ENGINES RATED AT 20,600 LB SLST
- NO ENGINE AIR BLEED FOR AIR CONDITIONING
- ZERO WIND, ZERO RUNWAY GRADIENT
- DRY RUNWAY SURFACE
- CONSULT WITH USING AIRLINE FOR SPECIFIC OPERATING PROCEDURE PRIOR TO FACILITY DESIGN

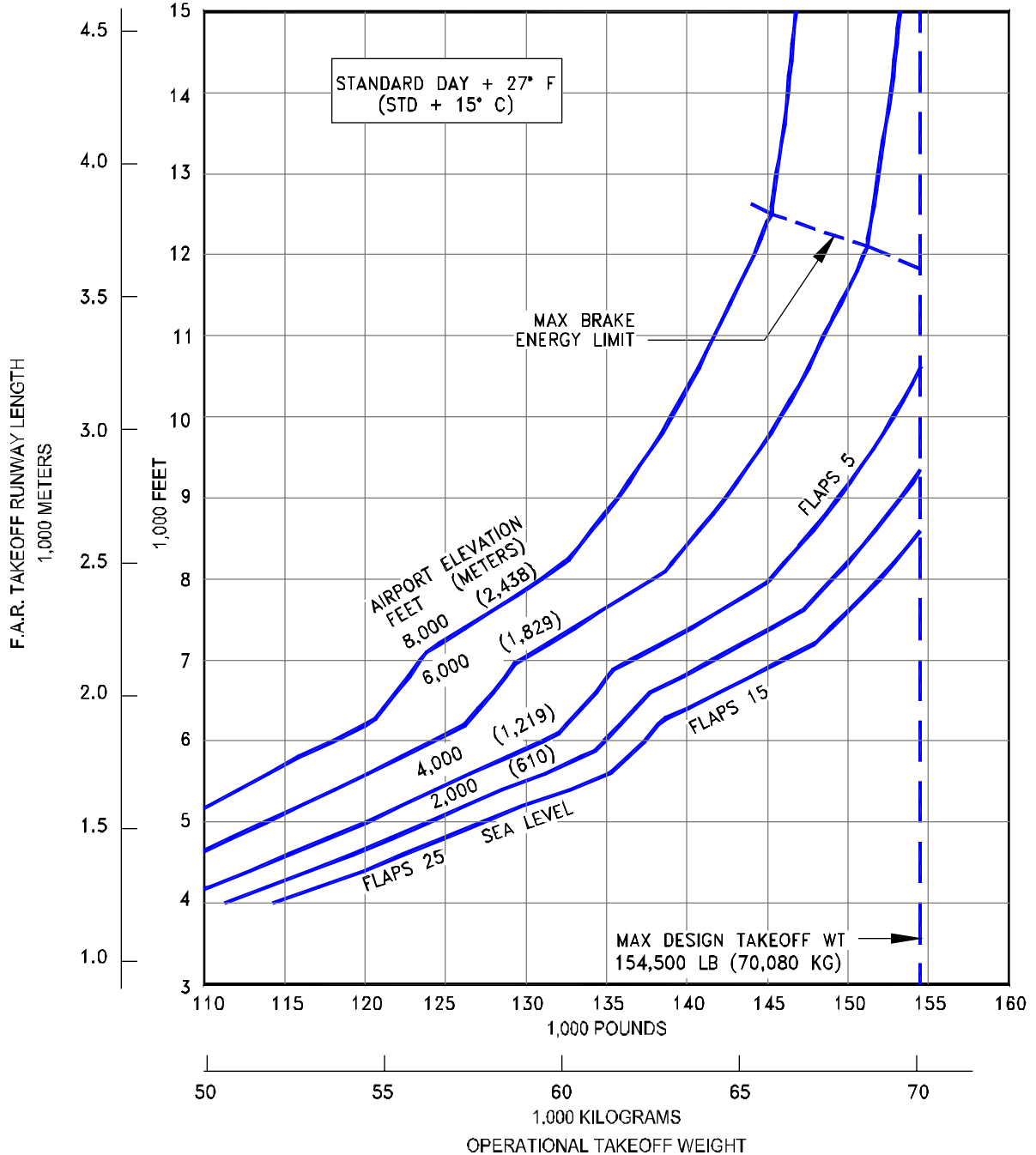

3.3.40 F.A.R. TAKEOFF RUNWAY LENGTH REQUIREMENTS

STANDARD DAY +27°F (STD + 15°C), DRY RUNWAY

MODEL 737-700 WITH WINGLETS (CFM56-7B22 ENGINES AT 20,600 LB SLST)

NOTES:

- CFM56-7B20 ENGINES RATED AT 20,600 LB SLST
- NO ENGINE AIR BLEED FOR AIR CONDITIONING
- ZERO WIND, ZERO RUNWAY GRADIENT
- WET SMOOTH RUNWAY SURFACE
- CONSULT WITH USING AIRLINE FOR SPECIFIC OPERATING PROCEDURE PRIOR TO FACILITY DESIGN
- TAKEOFF PERFORMANCE IMPROVEMENTS ARE POSSIBLE USING GROOVED RUNWAY

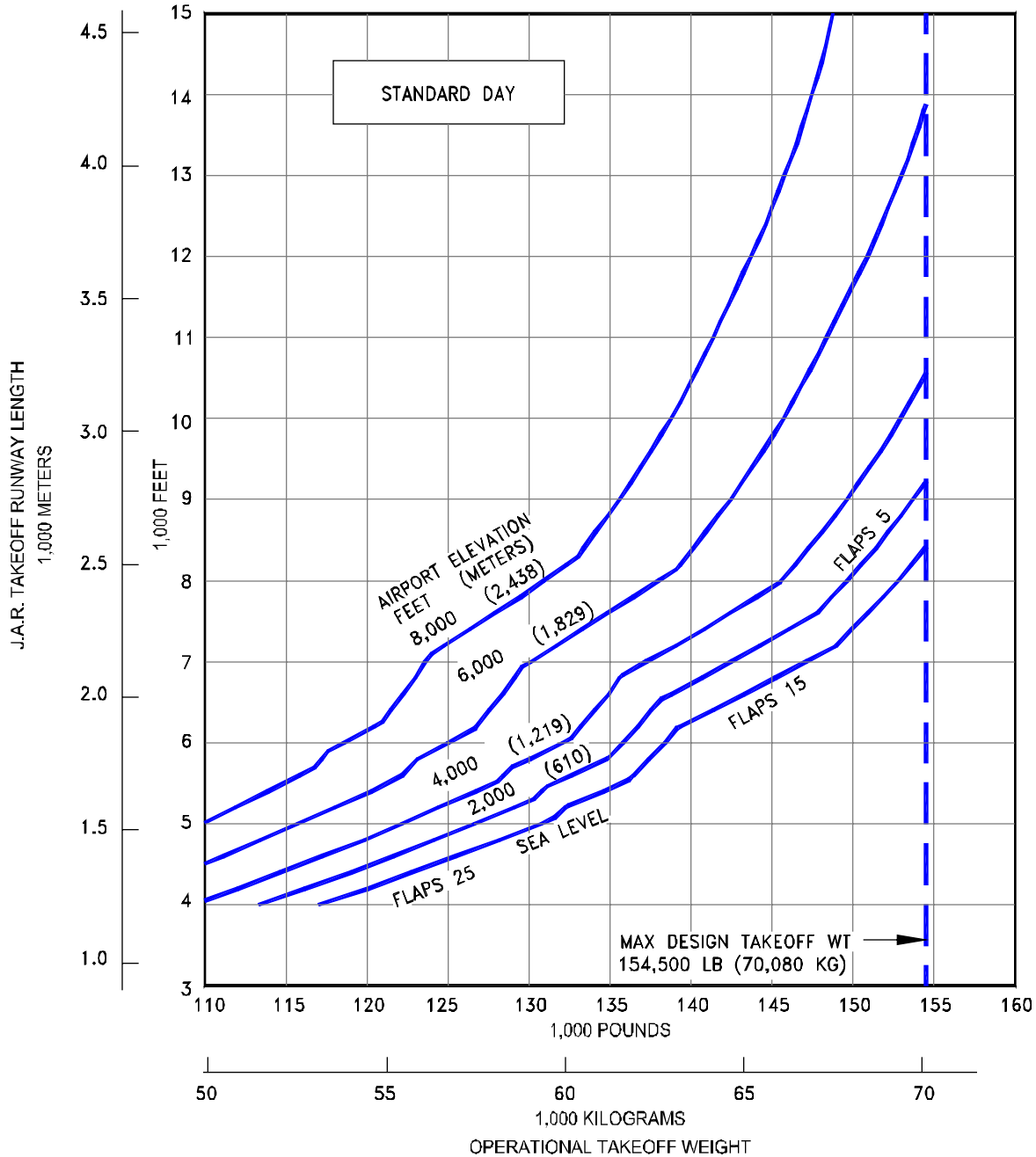

**3.3.41 J.A.R. TAKEOFF RUNWAY LENGTH REQUIREMENTS
STANDARD DAY, WET RUNWAY**

MODEL 737-700 WITH WINGLETS, (CFM56-7B20 ENGINES AT 20,600 LB SLST)

NOTES:

- CFM56-7B20 ENGINES RATED AT 20,600 LB SLST
- NO ENGINE AIR BLEED FOR AIR CONDITIONING
- ZERO WIND, ZERO RUNWAY GRADIENT
- WET SMOOTH RUNWAY SURFACE
- CONSULT WITH USING AIRLINE FOR SPECIFIC OPERATING PROCEDURE PRIOR TO FACILITY DESIGN
- TAKEOFF PERFORMANCE IMPROVEMENTS ARE POSSIBLE USING GROOVED RUNWAY

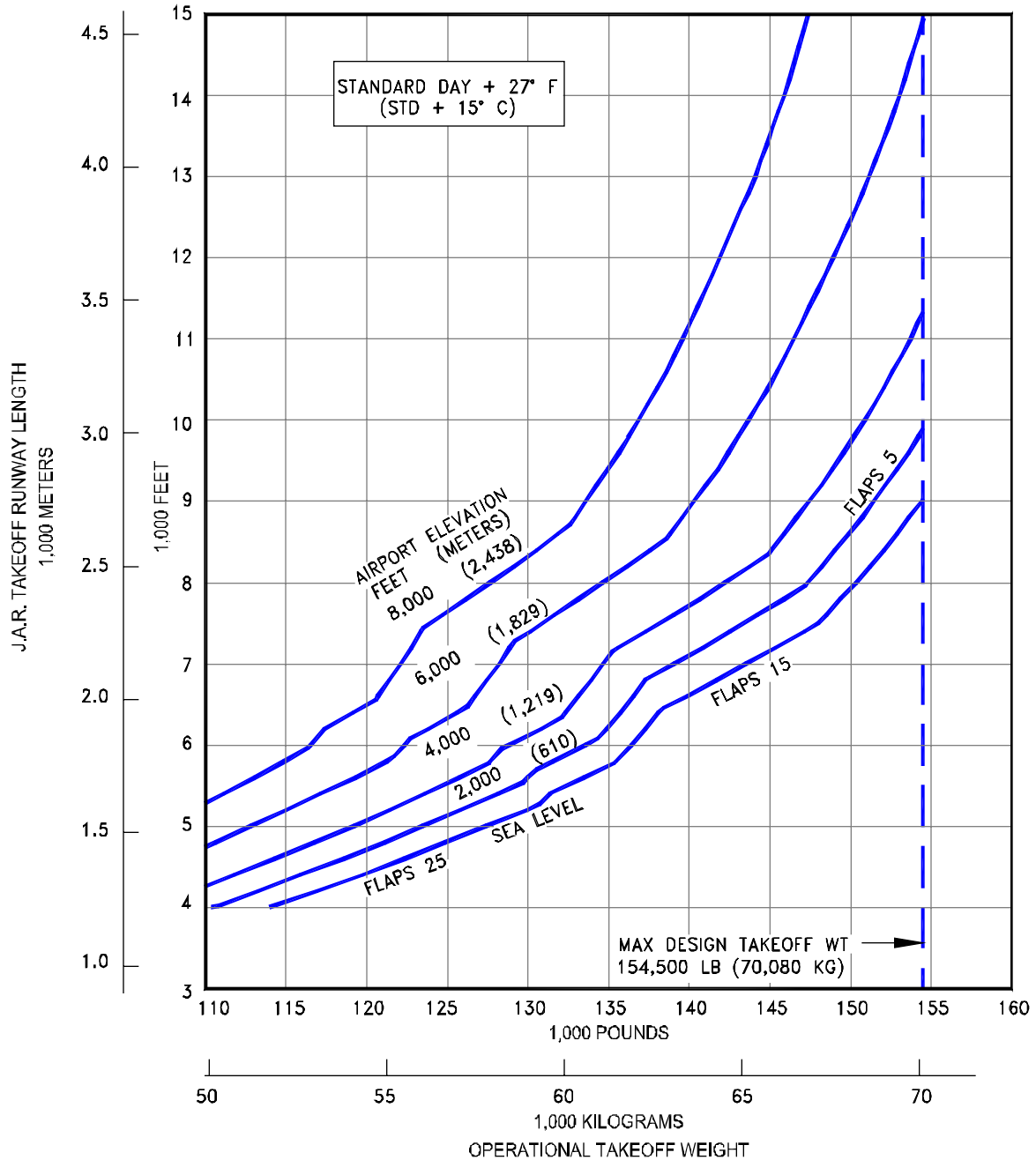

3.3.42 J.A.R. TAKEOFF RUNWAY LENGTH REQUIREMENTS

STANDARD DAY +27°F (STD + 15°C), WET RUNWAY

MODEL 737-700 WITH WINGLETS (CFM56-7B20 ENGINES AT 20,600 LB SLST)

NOTES:

- CFM56-7B22 ENGINES RATED AT 22,700 LB SLST
- NO ENGINE AIR BLEED FOR AIR CONDITIONING
- ZERO WIND, ZERO RUNWAY GRADIENT
- DRY RUNWAY SURFACE
- CONSULT WITH USING AIRLINE FOR SPECIFIC OPERATING PROCEDURE PRIOR TO FACILITY DESIGN

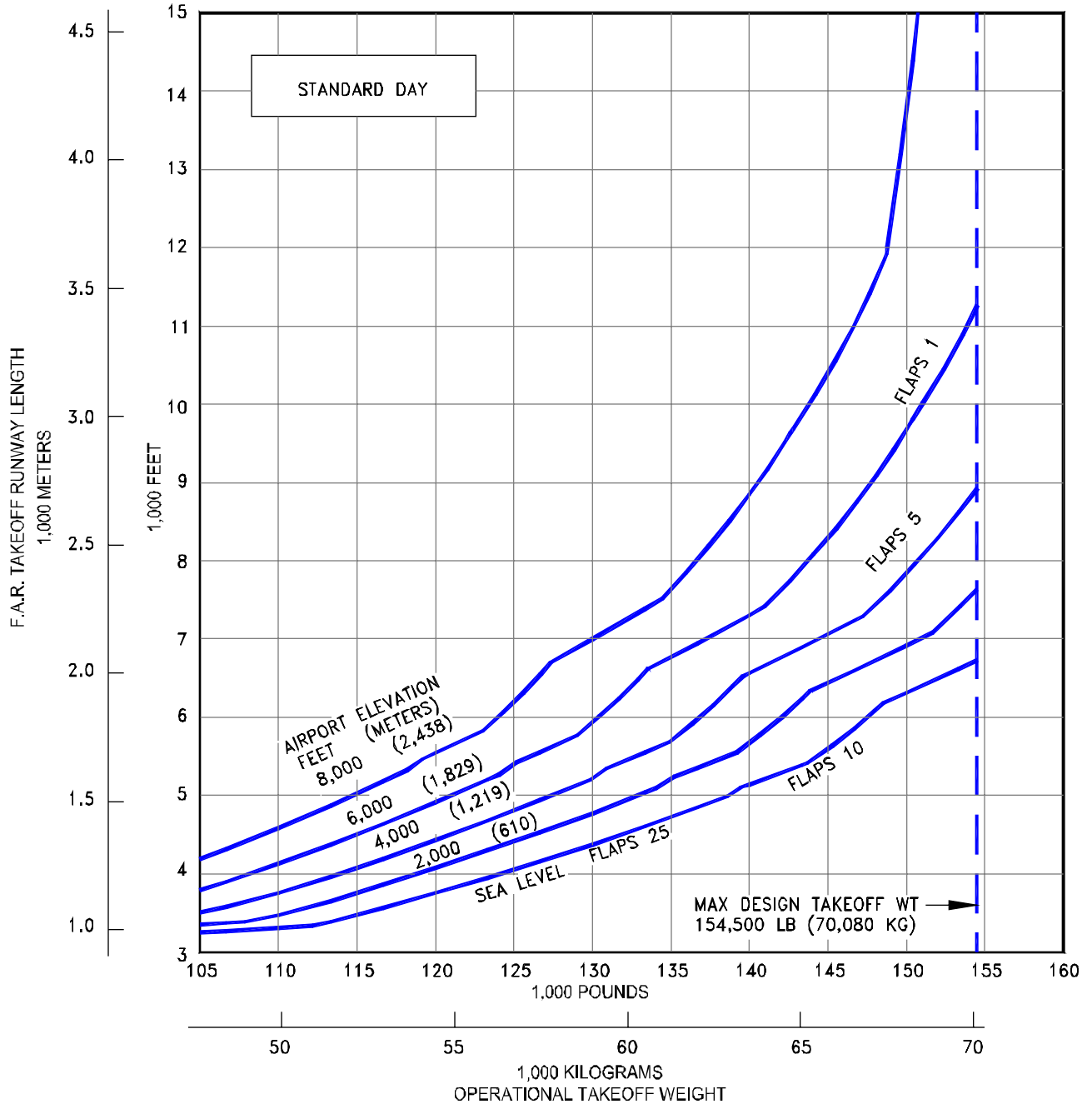

**3.3.43 F.A.R. TAKEOFF RUNWAY LENGTH REQUIREMENTS
STANDARD DAY, DRY RUNWAY**

MODEL 737-700 (CFM56-7B22 ENGINES AT 22,700 LB SLST)

D6-58325-6

NOTES:

- CFM56-7B22 ENGINES RATED AT 22,700 LB SLST
- NO ENGINE AIR BLEED FOR AIR CONDITIONING
- ZERO WIND, ZERO RUNWAY GRADIENT
- DRY RUNWAY SURFACE
- CONSULT WITH USING AIRLINE FOR SPECIFIC OPERATING PROCEDURE PRIOR TO FACILITY DESIGN

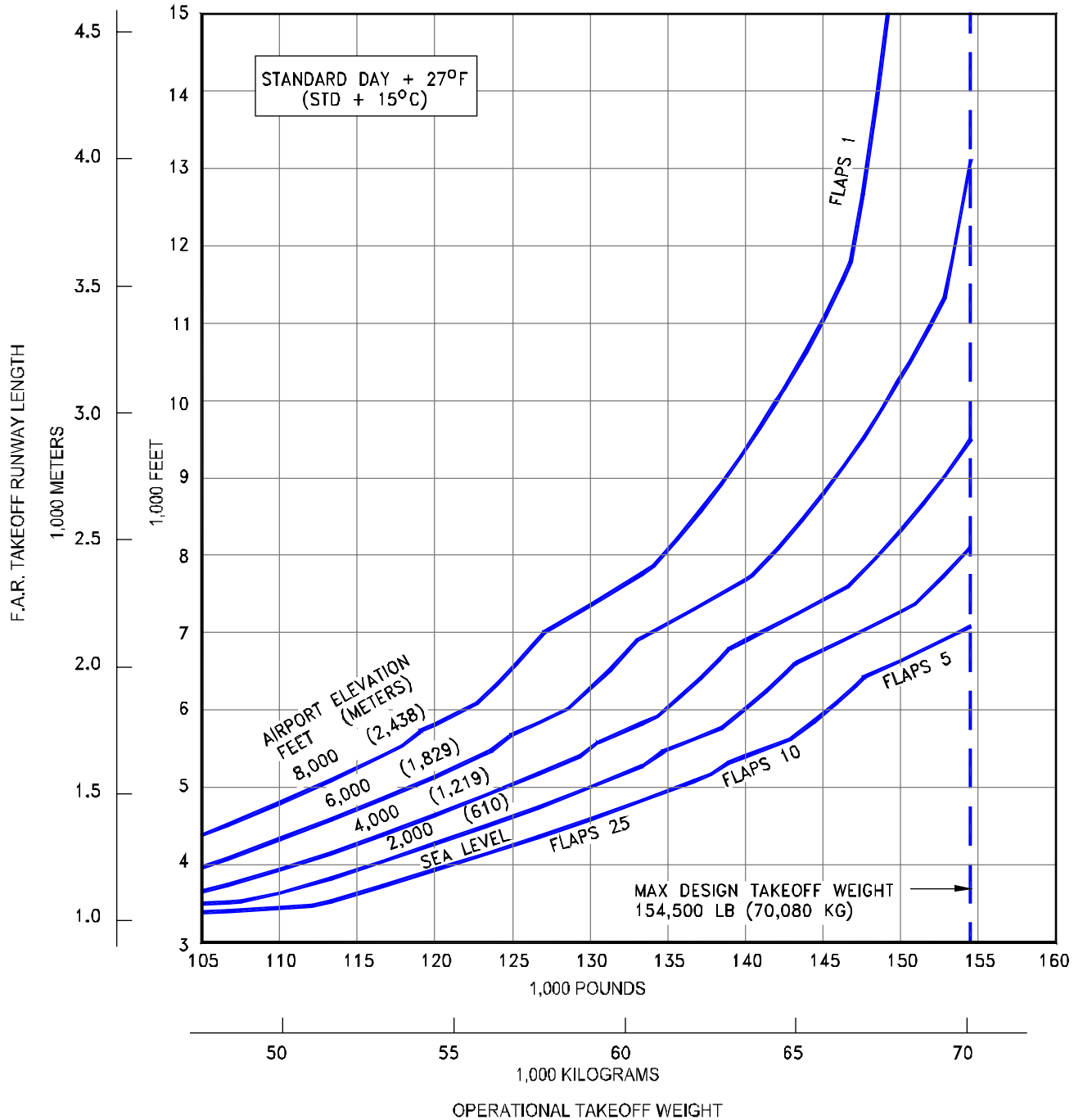

3.3.44 F.A.R. TAKEOFF RUNWAY LENGTH REQUIREMENTS
STANDARD DAY +27°F (STD + 15°C), DRY RUNWAY
MODEL 737-700 (CFM56-7B22 ENGINES AT 22,700 LB SLST)

NOTES:

- CFM56-7B22 ENGINES RATED AT 22,700 LB SLST
- NO ENGINE AIR BLEED FOR AIR CONDITIONING
- ZERO WIND, ZERO RUNWAY GRADIENT
- WET SMOOTH RUNWAY SURFACE
- CONSULT WITH USING AIRLINE FOR SPECIFIC OPERATING PROCEDURE PRIOR TO FACILITY DESIGN
- TAKEOFF PERFORMANCE IMPROVEMENTS ARE POSSIBLE USING GROOVED RUNWAY

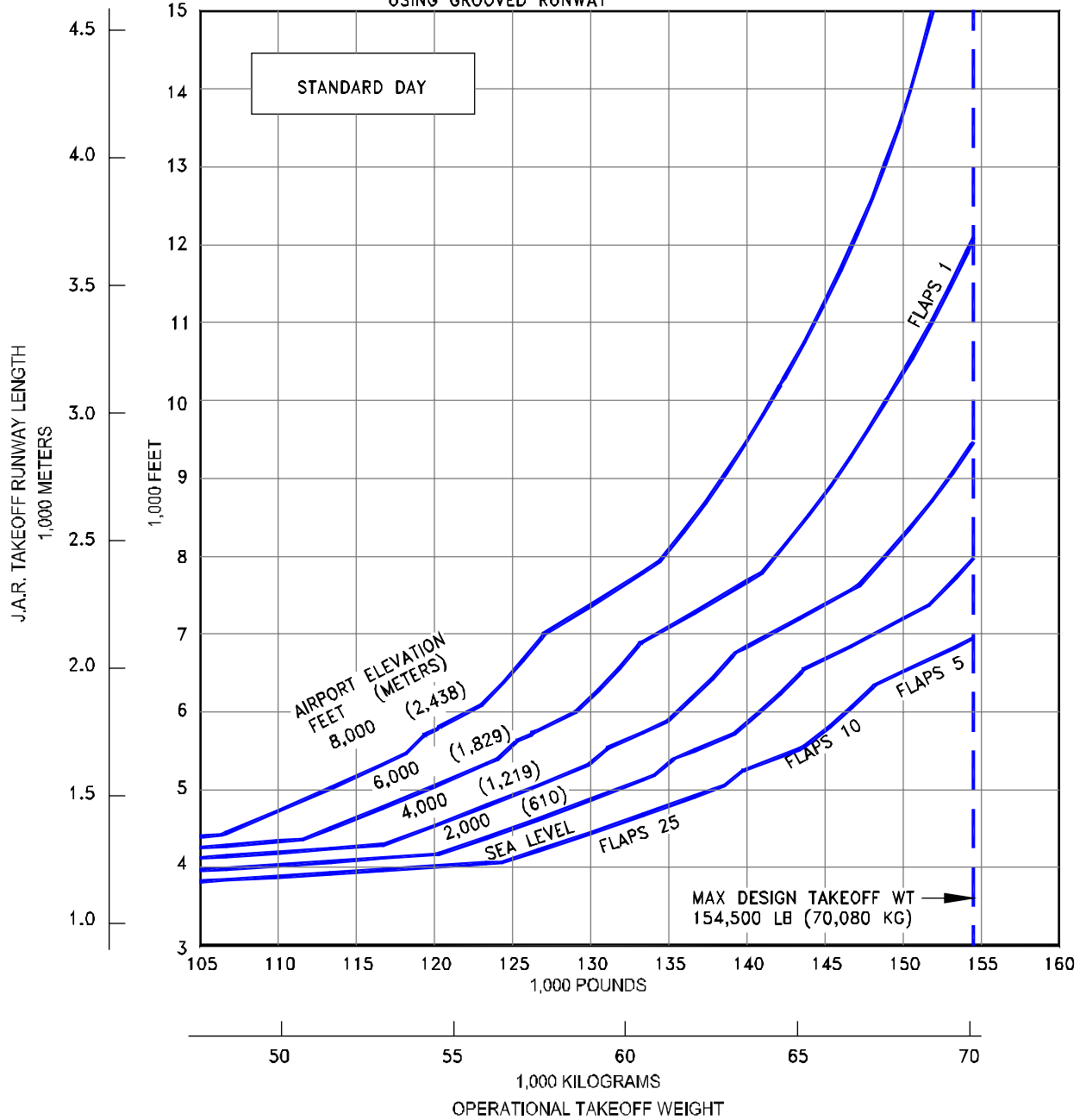

3.3.45 J.A.R. TAKEOFF RUNWAY LENGTH REQUIREMENTS
STANDARD DAY, WET RUNWAY
MODEL 737-700 (CFM56-7B22 ENGINES AT 22,700 LB SLST)

NOTES:

- CFM56-7B22 ENGINES RATED AT 22,700 LB SLST
- NO ENGINE AIR BLEED FOR AIR CONDITIONING
- ZERO WIND, ZERO RUNWAY GRADIENT
- WET SMOOTH RUNWAY SURFACE
- CONSULT WITH USING AIRLINE FOR SPECIFIC OPERATING PROCEDURE PRIOR TO FACILITY DESIGN
- TAKEOFF PERFORMANCE IMPROVEMENTS ARE POSSIBLE USING GROOVED RUNWAY

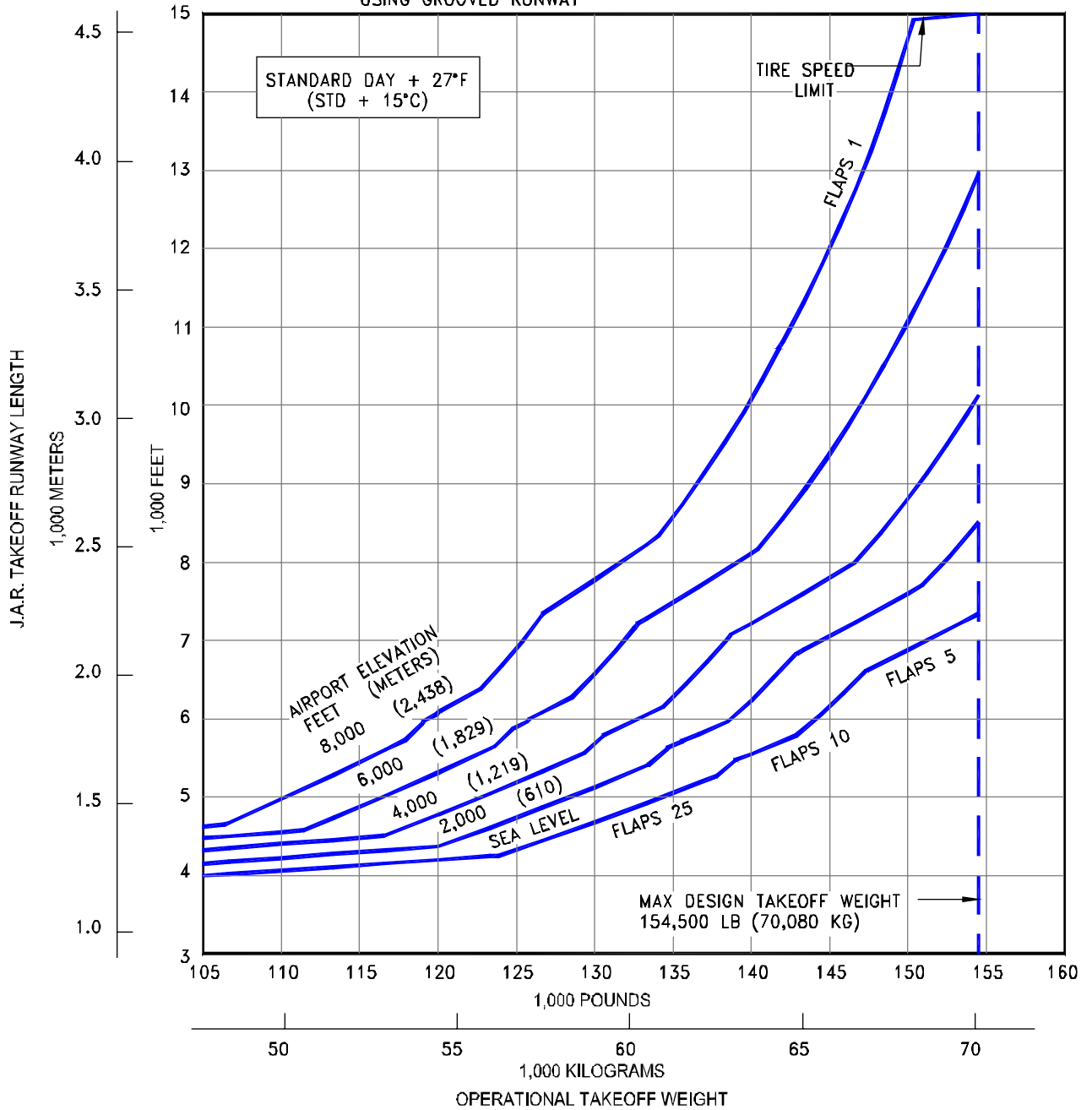

3.3.46 J.A.R. TAKEOFF RUNWAY LENGTH REQUIREMENTS
STANDARD DAY +27°F (STD + 15°C), WET RUNWAY
MODEL 737-700 (CFM56-7B22 ENGINES AT 22,700 LB SLST)

NOTES:

- CFM56-7B22 ENGINES RATED AT 22,700 LB SLST
- NO ENGINE AIR BLEED FOR AIR CONDITIONING
- ZERO WIND, ZERO RUNWAY GRADIENT
- DRY RUNWAY SURFACE
- CONSULT WITH USING AIRLINE FOR SPECIFIC OPERATING PROCEDURE PRIOR TO FACILITY DESIGN

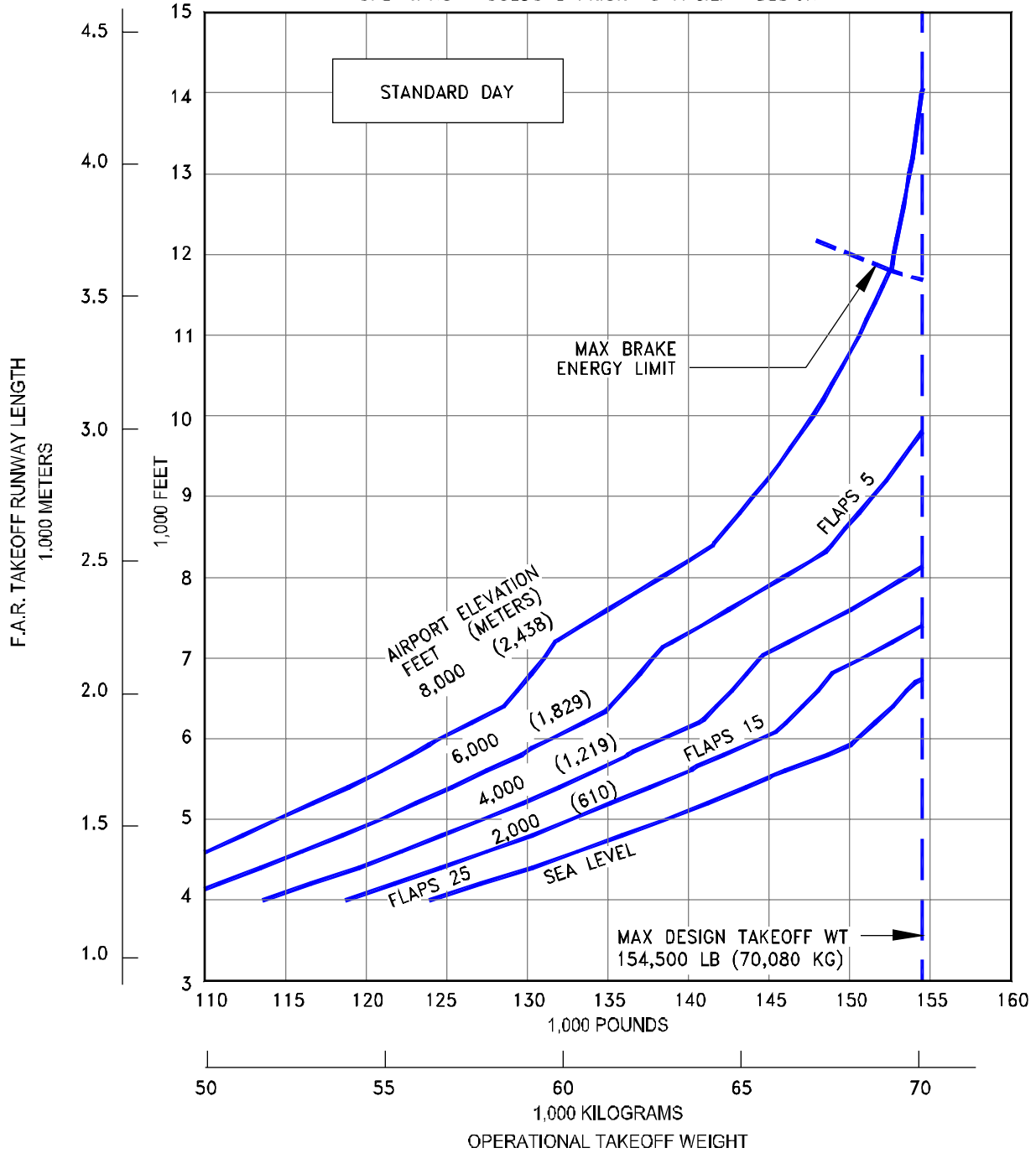

**3.3.47 F.A.R. TAKEOFF RUNWAY LENGTH REQUIREMENTS
STANDARD DAY, DRY RUNWAY**

MODEL 737-700 WITH WINGLETS (CFM56-7B22 ENGINES AT 22,700 LB SLST)

D6-58325-6

NOTES:

- CFM56-7B22 ENGINES RATED AT 22,700 LB SLST
- NO ENGINE AIR BLEED FOR AIR CONDITIONING
- ZERO WIND, ZERO RUNWAY GRADIENT
- DRY RUNWAY SURFACE
- CONSULT WITH USING AIRLINE FOR SPECIFIC OPERATING PROCEDURE PRIOR TO FACILITY DESIGN

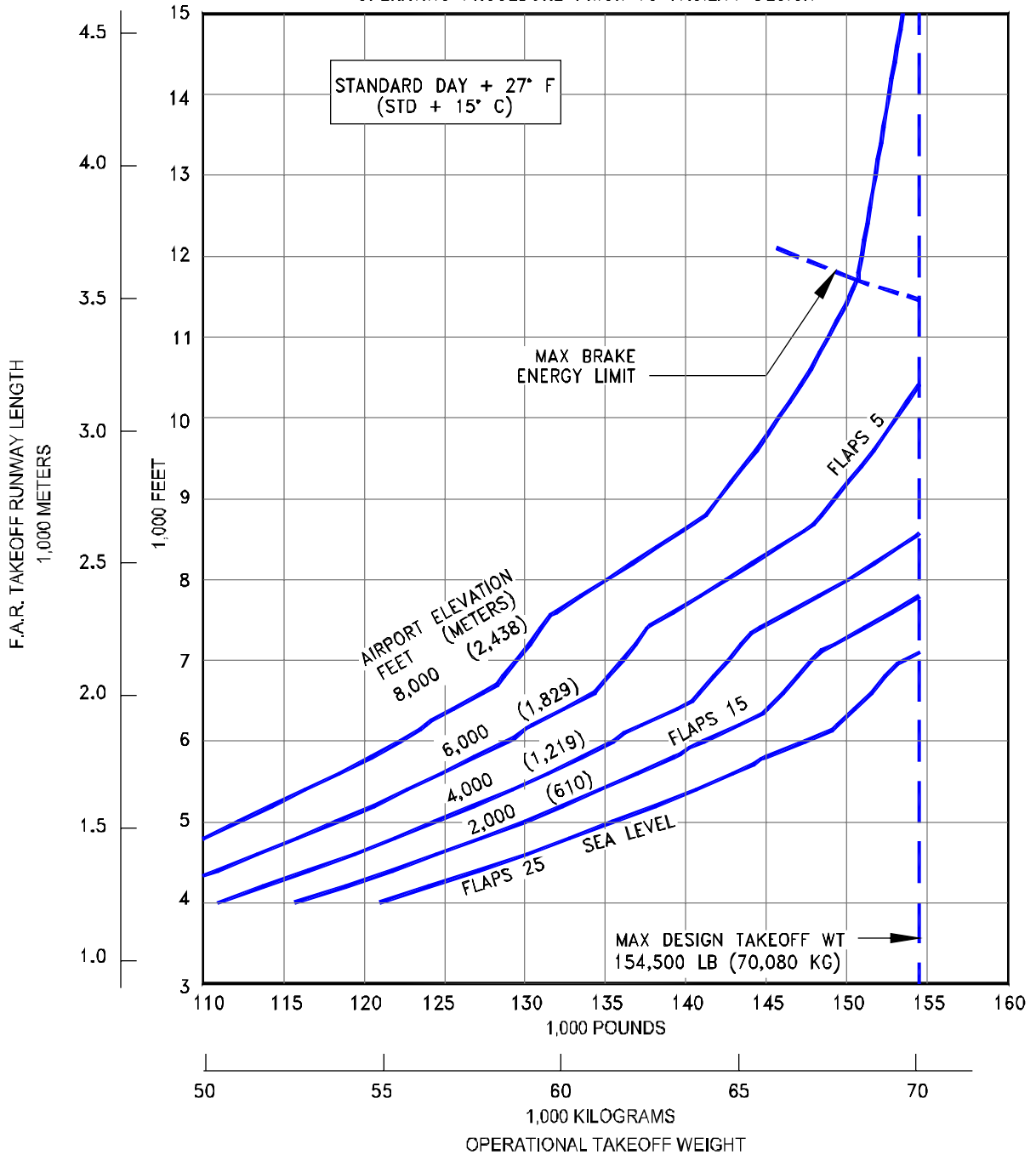

3.3.48 F.A.R. TAKEOFF RUNWAY LENGTH REQUIREMENTS

STANDARD DAY +27°F (STD + 15°C), DRY RUNWAY

MODEL 737-700 WITH WINGLETS (CFM56-7B22 ENGINES AT 22,700 LB SLST)

NOTES:

- ◆ CFM56-7B22 ENGINES RATED AT 22,700 LB SLST
- ◆ NO ENGINE AIR BLEED FOR AIR CONDITIONING
- ◆ ZERO WIND, ZERO RUNWAY GRADIENT
- ◆ WET SMOOTH RUNWAY SURFACE
- ◆ CONSULT WITH USING AIRLINE FOR SPECIFIC OPERATING PROCEDURE PRIOR TO FACILITY DESIGN
- ◆ TAKEOFF PERFORMANCE IMPROVEMENTS ARE POSSIBLE USING GROOVED RUNWAY

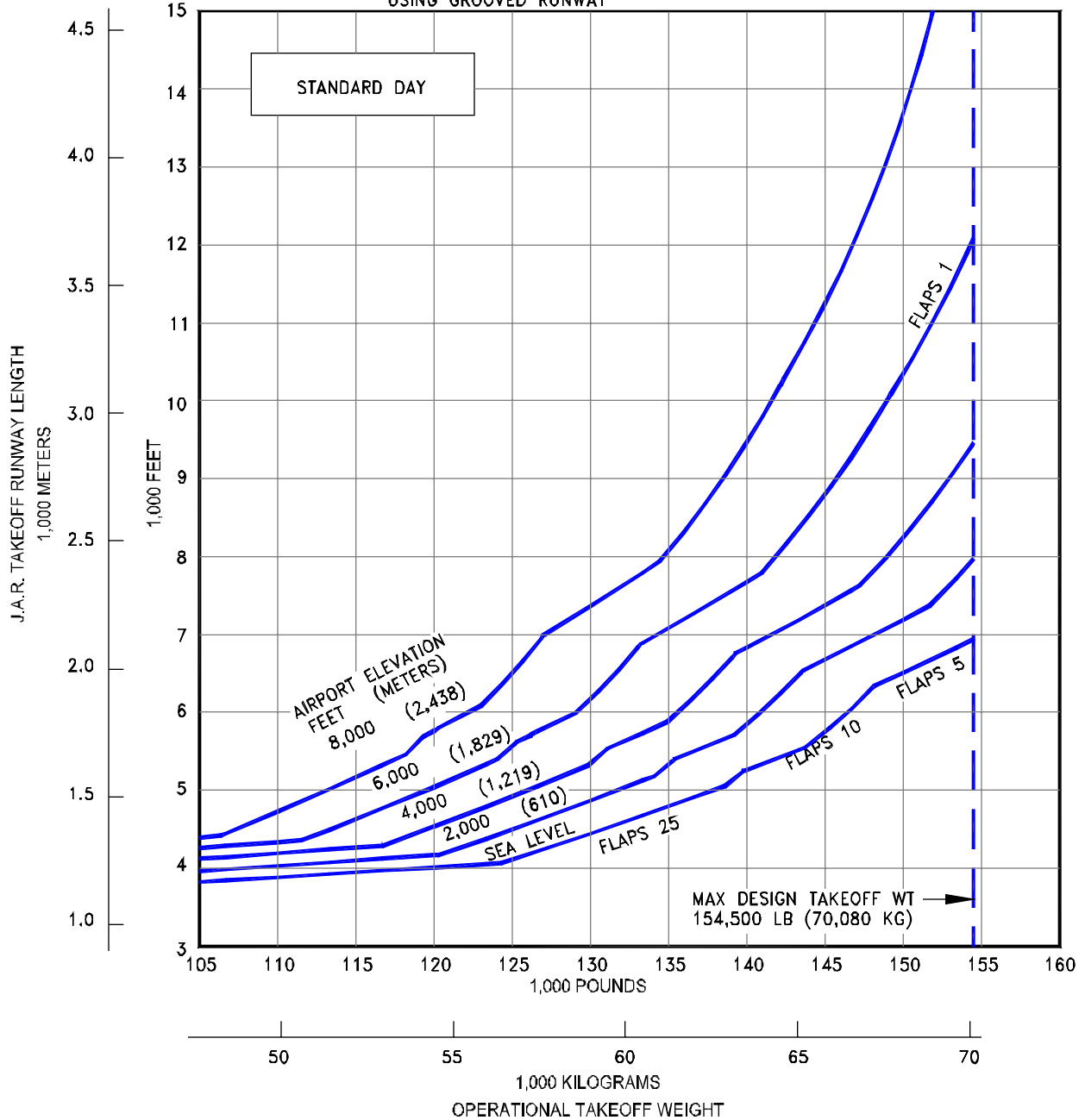

3.3.49 J.A.R. TAKEOFF RUNWAY LENGTH REQUIREMENTS
STANDARD DAY, WET RUNWAY
MODEL 737-700 (CFM56-7B22 ENGINES AT 22,700 LB SLST)

NOTES:

- CFM56-7B22 ENGINES RATED AT 22,700 LB SLST
- NO ENGINE AIR BLEED FOR AIR CONDITIONING
- ZERO WIND, ZERO RUNWAY GRADIENT
- WET SMOOTH RUNWAY SURFACE
- CONSULT WITH USING AIRLINE FOR SPECIFIC OPERATING PROCEDURE PRIOR TO FACILITY DESIGN

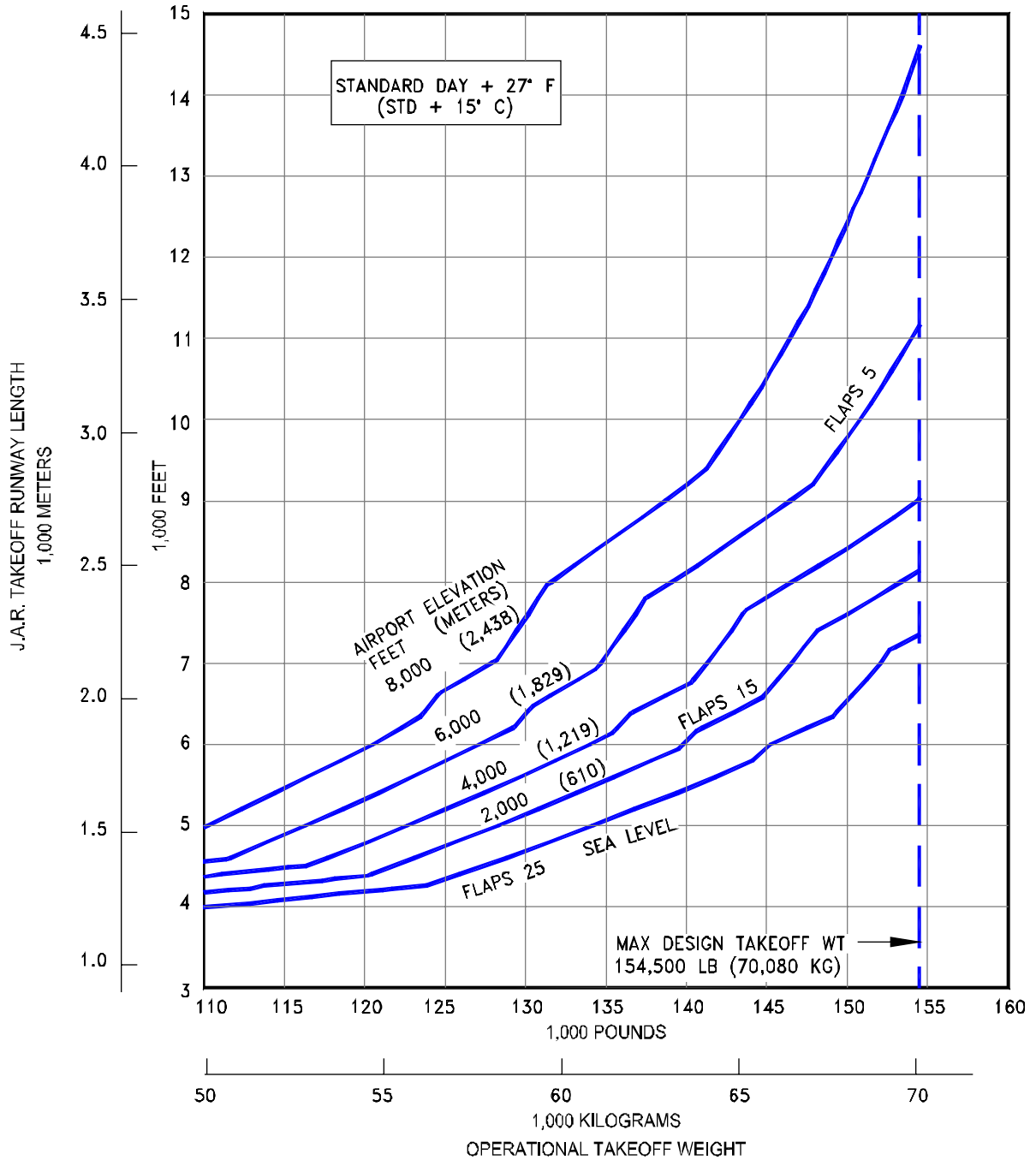

3.3.50 F.A.R. TAKEOFF RUNWAY LENGTH REQUIREMENTS

STANDARD DAY +27°F (STD + 15°C), DRY RUNWAY

MODEL 737-700 WITH WINGLETS (CFM56-7B22 ENGINES AT 22,700 LB SLST)

NOTES:

- CFM56-7B24 ENGINES RATED AT 24,200 LB SLST
- NO ENGINE AIR BLEED FOR AIR CONDITIONING
- ZERO WIND, ZERO RUNWAY GRADIENT
- DRY RUNWAY SURFACE
- CONSULT WITH USING AIRLINE FOR SPECIFIC OPERATING PROCEDURE PRIOR TO FACILITY DESIGN

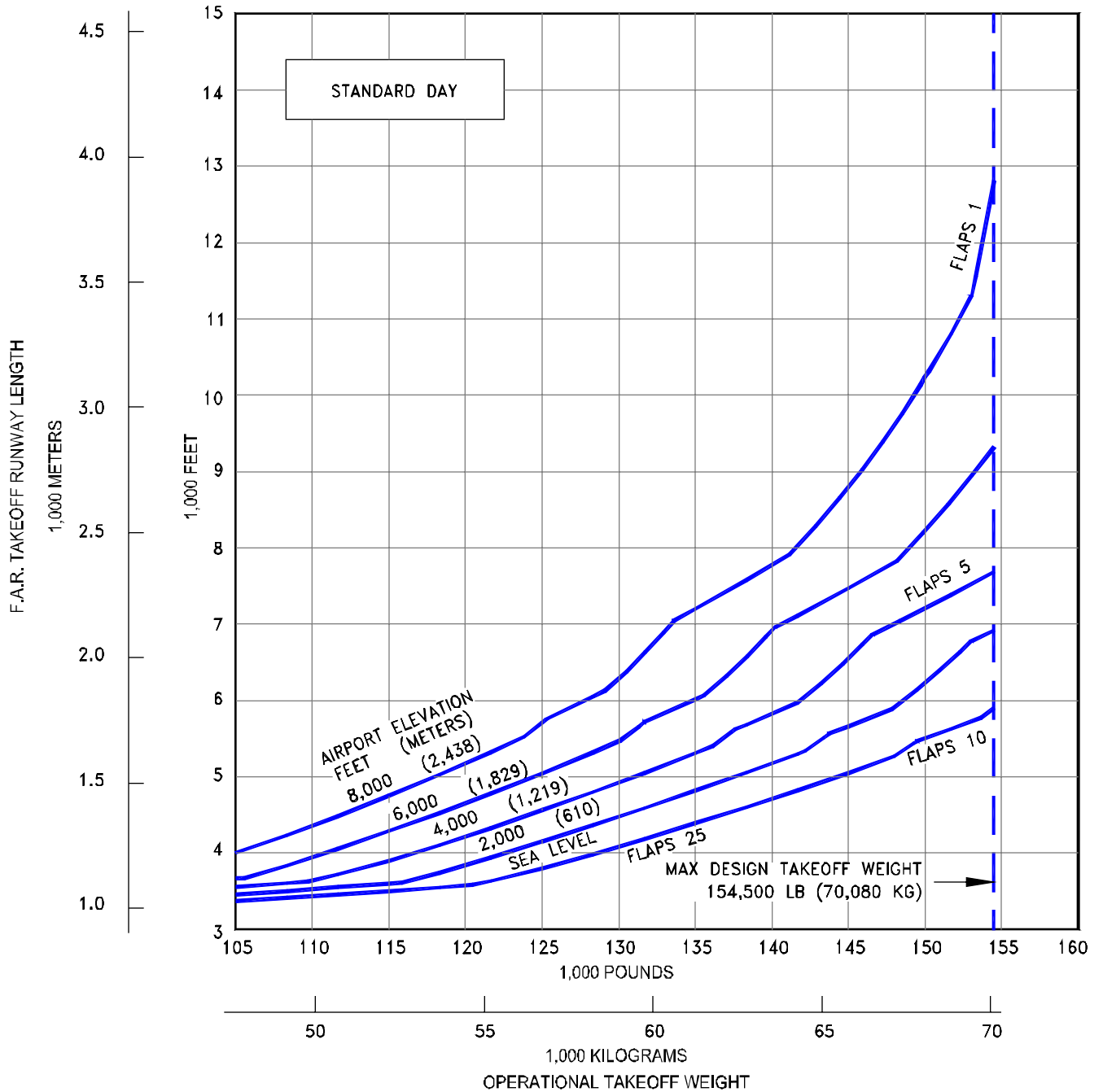

**3.3.51 F.A.R. TAKEOFF RUNWAY LENGTH REQUIREMENTS
STANDARD DAY, DRY RUNWAY
MODE L 737-700 (CFM56-7B24 ENGINES AT 24,200 LB SLST)**

NOTES:

- CFM56-7B24 ENGINES RATED AT 24,200 LB SLST
- NO ENGINE AIR BLEED FOR AIR CONDITIONING
- ZERO WIND, ZERO RUNWAY GRADIENT
- DRY RUNWAY SURFACE
- CONSULT WITH USING AIRLINE FOR SPECIFIC OPERATING PROCEDURE PRIOR TO FACILITY DESIGN

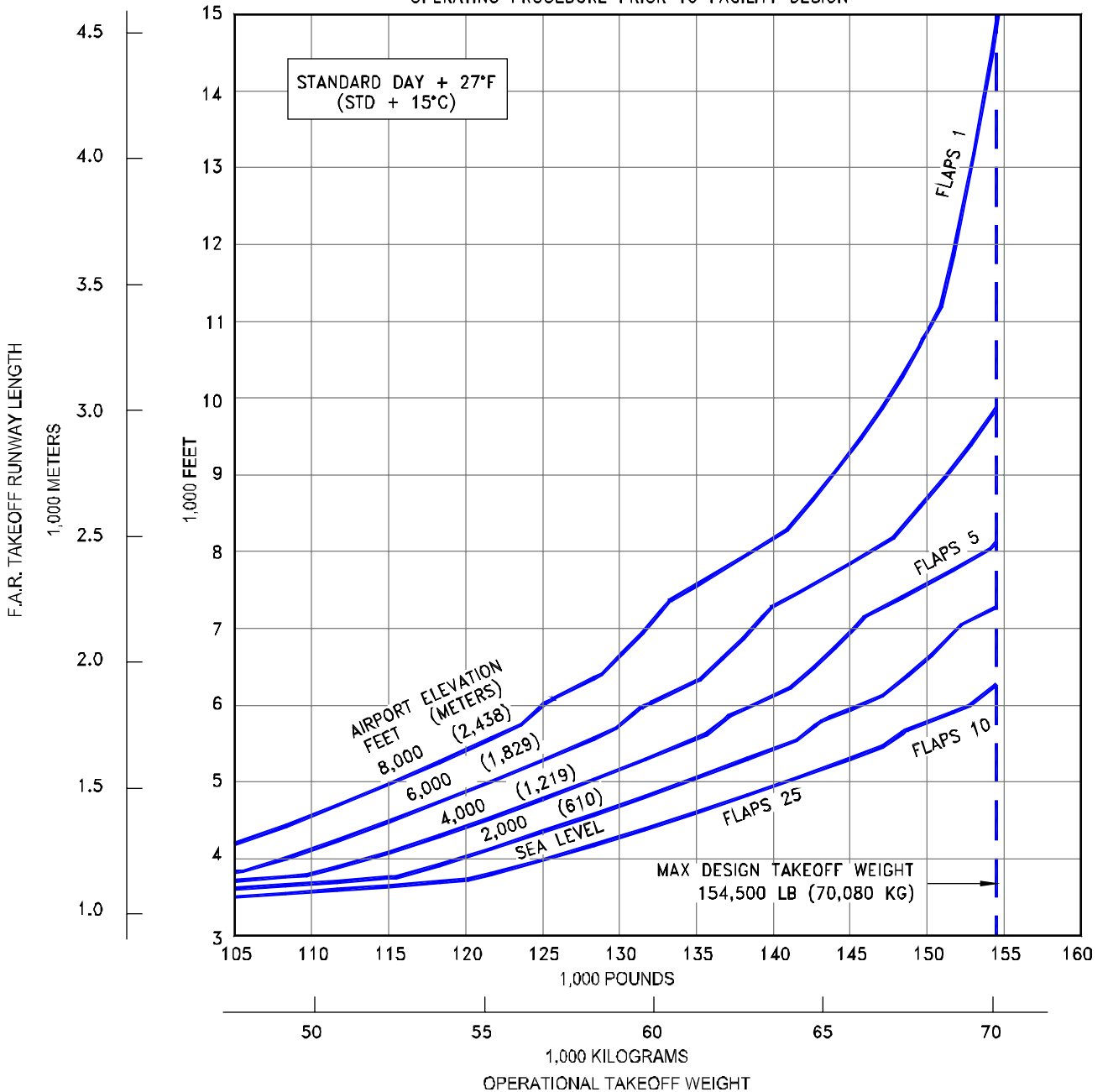

3.3.52 F.A.R. TAKEOFF RUNWAY LENGTH REQUIREMENTS
STANDARD DAY +27°F (STD + 15°C), DRY RUNWAY
MODEL 737-700 (CFM56-7B24 ENGINES AT 24,200 LB SLST)

NOTES:

- CFM56-7B24 ENGINES RATED AT 24,200 LB SLST
- NO ENGINE AIR BLEED FOR AIR CONDITIONING
- ZERO WIND, ZERO RUNWAY GRADIENT
- WET SMOOTH RUNWAY SURFACE
- CONSULT WITH USING AIRLINE FOR SPECIFIC OPERATING PROCEDURE PRIOR TO FACILITY DESIGN
- TAKEOFF PERFORMANCE IMPROVEMENTS ARE POSSIBLE USING GROOVED RUNWAY

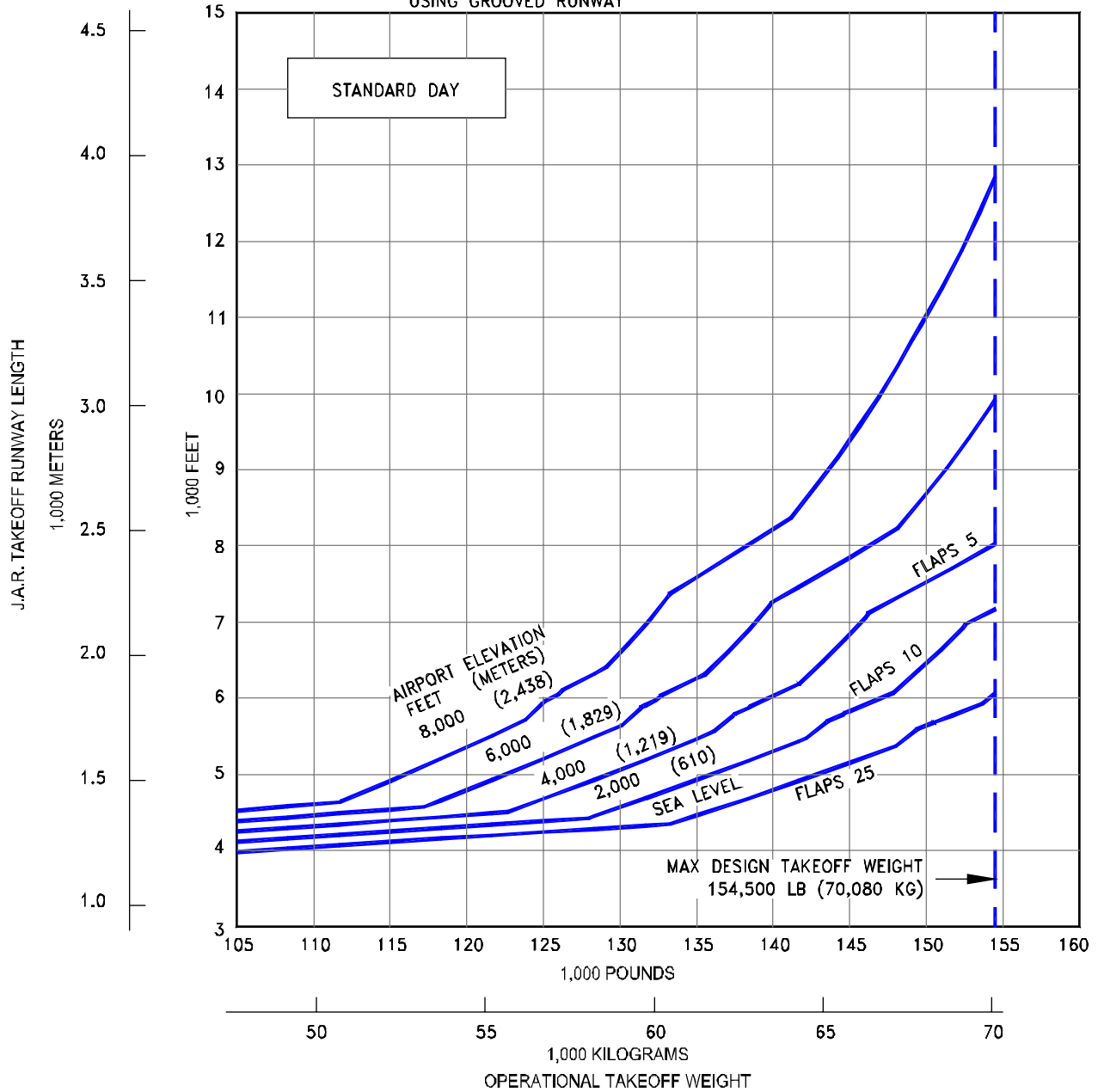

3.3.53 J.A.R. TAKEOFF RUNWAY LENGTH REQUIREMENTS
STANDARD DAY, WET RUNWAY
MODEL 737-700 (CFM56-7B24 ENGINES AT 24,200 LB SLST)

NOTES:

- CFM56-7B24 ENGINES RATED AT 24,200 LB SLST
- NO ENGINE AIR BLEED FOR AIR CONDITIONING
- ZERO WIND, ZERO RUNWAY GRADIENT
- WET SMOOTH RUNWAY SURFACE
- CONSULT WITH USING AIRLINE FOR SPECIFIC OPERATING PROCEDURE PRIOR TO FACILITY DESIGN
- TAKEOFF PERFORMANCE IMPROVEMENTS ARE POSSIBLE USING GROOVED RUNWAY

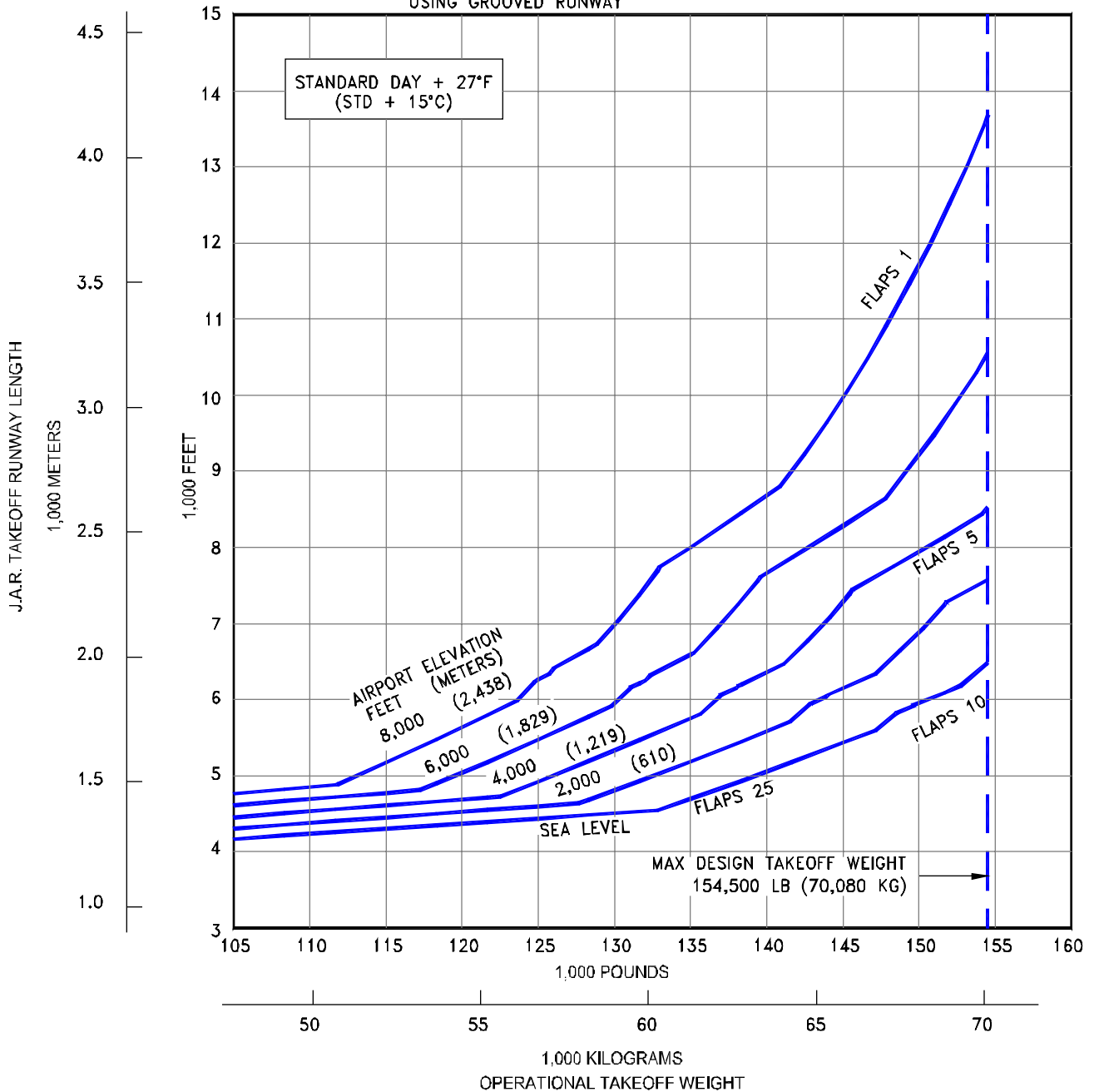

3.3.54 J.A.R. TAKEOFF RUNWAY LENGTH REQUIREMENTS
STANDARD DAY +27°F (STD + 15°C), WET RUNWAY
MODEL 737-700 (CFM56-7B24 ENGINES AT 24,200 LB SLST)

NOTES:

- CFM56-7B24 ENGINES RATED AT 24,200 LB SLST
- NO ENGINE AIR BLEED FOR AIR CONDITIONING
- ZERO WIND, ZERO RUNWAY GRADIENT
- DRY RUNWAY SURFACE
- CONSULT WITH USING AIRLINE FOR SPECIFIC OPERATING PROCEDURE PRIOR TO FACILITY DESIGN

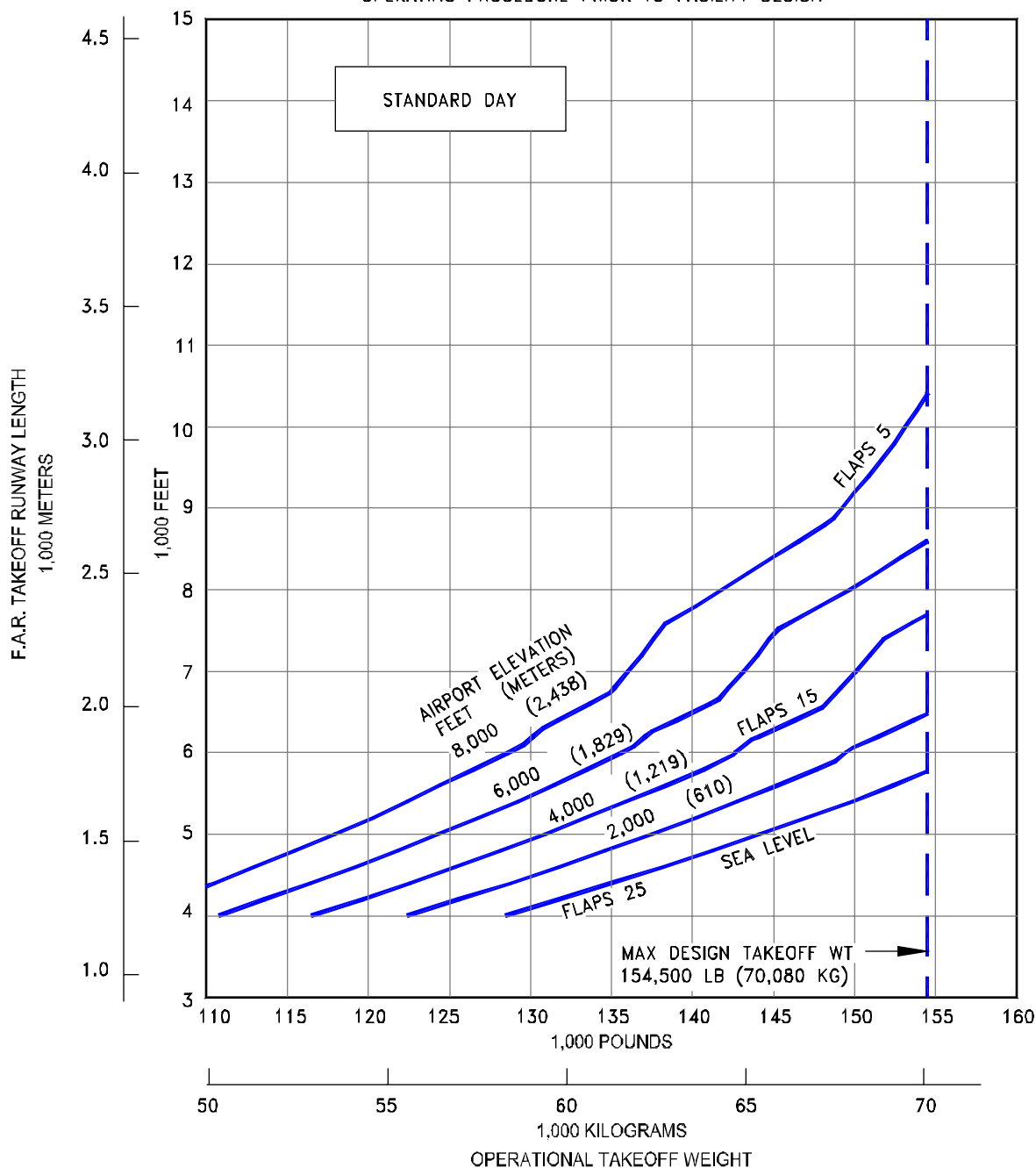

**3.3.55 F.A.R. TAKEOFF RUNWAY LENGTH REQUIREMENTS
STANDARD DAY, DRY RUNWAY**

MODEL 737-700 WITH WINGLETS, (CFM56-7B24 ENGINES AT 24,200 LB SLST)

NOTES:

- CFM56-7B24 ENGINES RATED AT 24,200 LB SLST
- NO ENGINE AIR BLEED FOR AIR CONDITIONING
- ZERO WIND, ZERO RUNWAY GRADIENT
- DRY RUNWAY SURFACE
- CONSULT WITH USING AIRLINE FOR SPECIFIC OPERATING PROCEDURE PRIOR TO FACILITY DESIGN

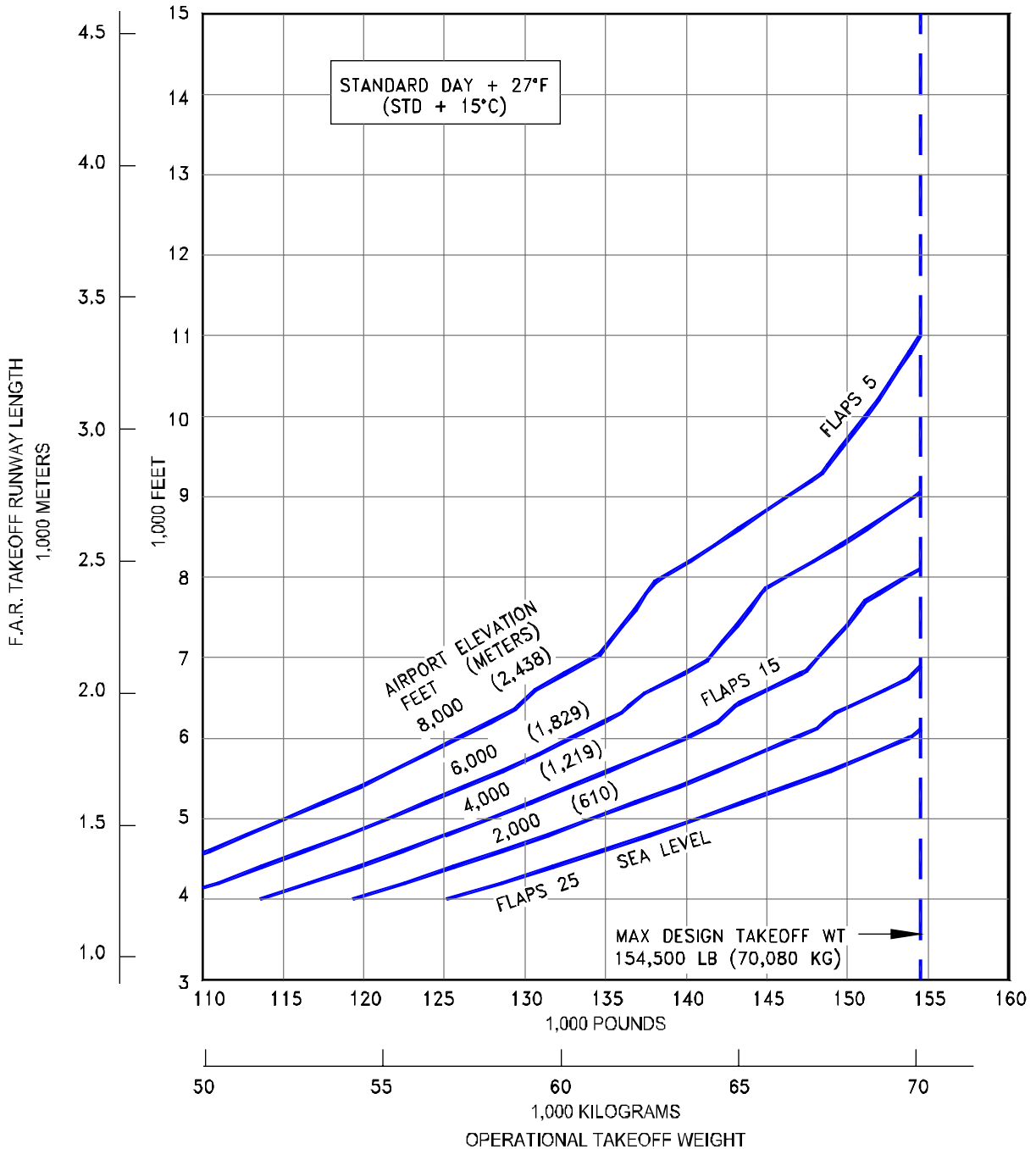

3.3.56 F.A.R. TAKEOFF RUNWAY LENGTH REQUIREMENTS

STANDARD DAY +27°F (STD + 15°C), DRY RUNWAY

MODEL 737-700 WITH WINGLETS, (CFM56-7B24 ENGINES AT 24,200 LB SLST)

NOTES:

- CFM56-7B24 ENGINES RATED AT 24,200 LB SLST
- NO ENGINE AIR BLEED FOR AIR CONDITIONING
- ZERO WIND, ZERO RUNWAY GRADIENT
- WET SMOOTH RUNWAY SURFACE
- CONSULT WITH USING AIRLINE FOR SPECIFIC OPERATING PROCEDURE PRIOR TO FACILITY DESIGN
- TAKEOFF PERFORMANCE IMPROVEMENTS ARE POSSIBLE USING GROOVED RUNWAY

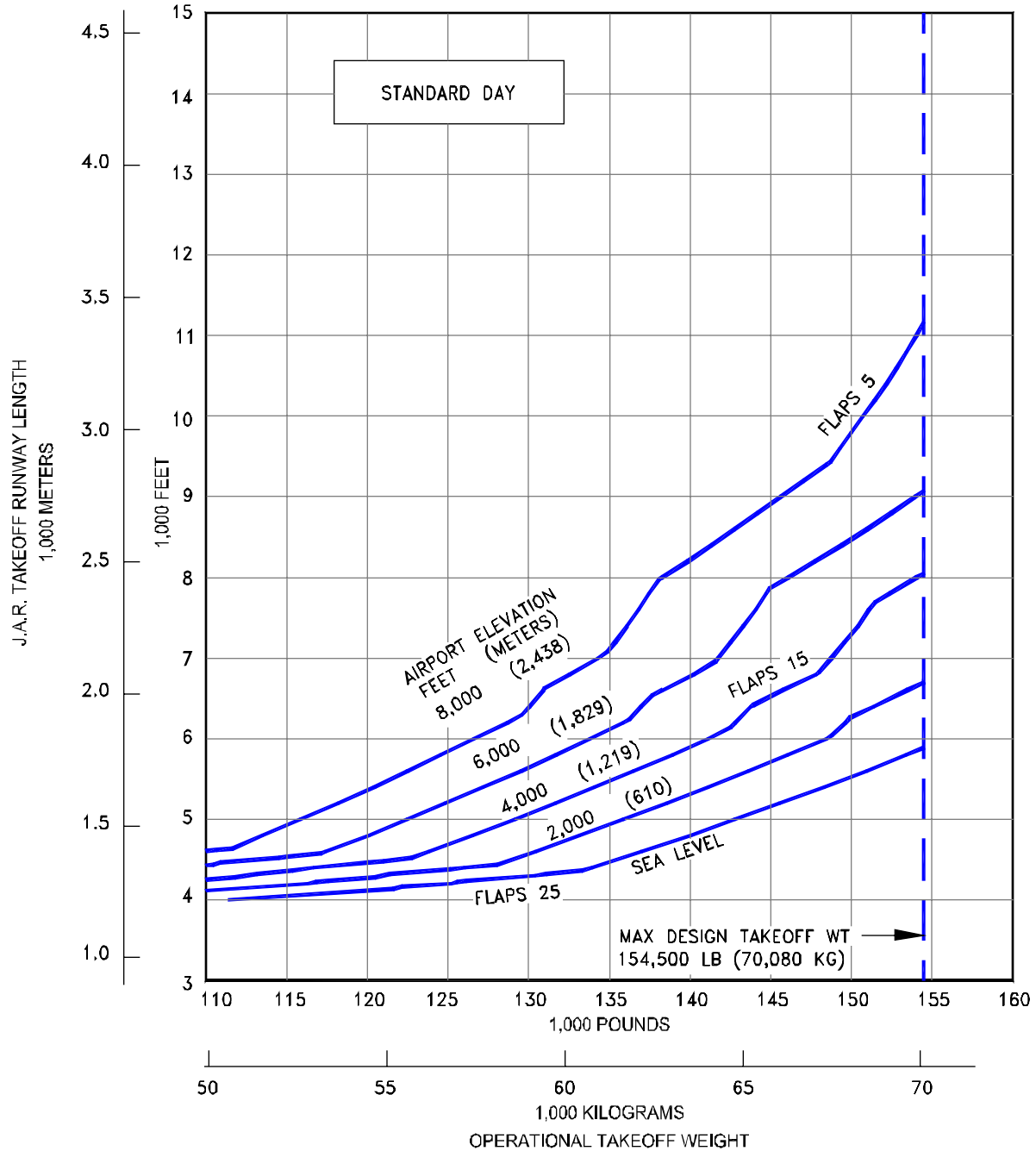

**3.3.57 J.A.R. TAKEOFF RUNWAY LENGTH REQUIREMENTS
STANDARD DAY, WET RUNWAY**

MODEL 737-700 WITH WINGLETS, (CFM56-7B24 ENGINES AT 24,200 LB SLST)

NOTES:

- CFM56-7B24 ENGINES RATED AT 24,200 LB SLST
- NO ENGINE AIR BLEED FOR AIR CONDITIONING
- ZERO WIND, ZERO RUNWAY GRADIENT
- WET SMOOTH RUNWAY SURFACE
- CONSULT WITH USING AIRLINE FOR SPECIFIC OPERATING PROCEDURE PRIOR TO FACILITY DESIGN
- TAKEOFF PERFORMANCE IMPROVEMENTS ARE POSSIBLE USING GROOVED RUNWAY

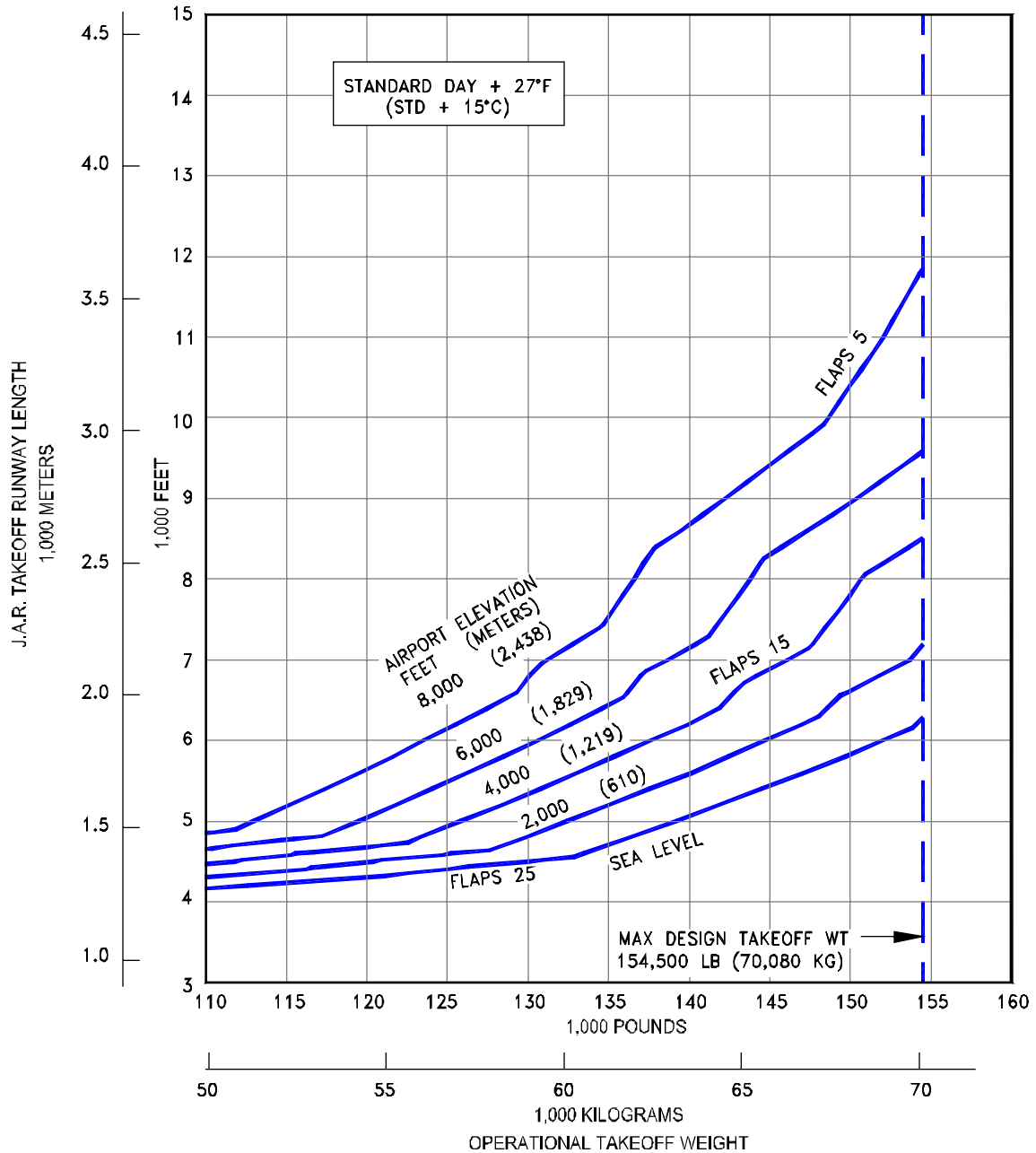

3.3.58 J.A.R. TAKEOFF RUNWAY LENGTH REQUIREMENTS

STANDARD DAY +27°F (STD + 15°C), WET RUNWAY

MODEL 737-700 WITH WINGLETS, (CFM56-7B24 ENGINES AT 24,200 LB SLST)

NOTES:

- CFM56-7B24B1 ENGINES RATED AT 24,200 LB SLST
- NO ENGINE AIR BLEED FOR AIR CONDITIONING
- ZERO WIND, ZERO RUNWAY GRADIENT
- DRY RUNWAY SURFACE
- CONSULT WITH USING AIRLINE FOR SPECIFIC OPERATING PROCEDURE PRIOR TO FACILITY DESIGN

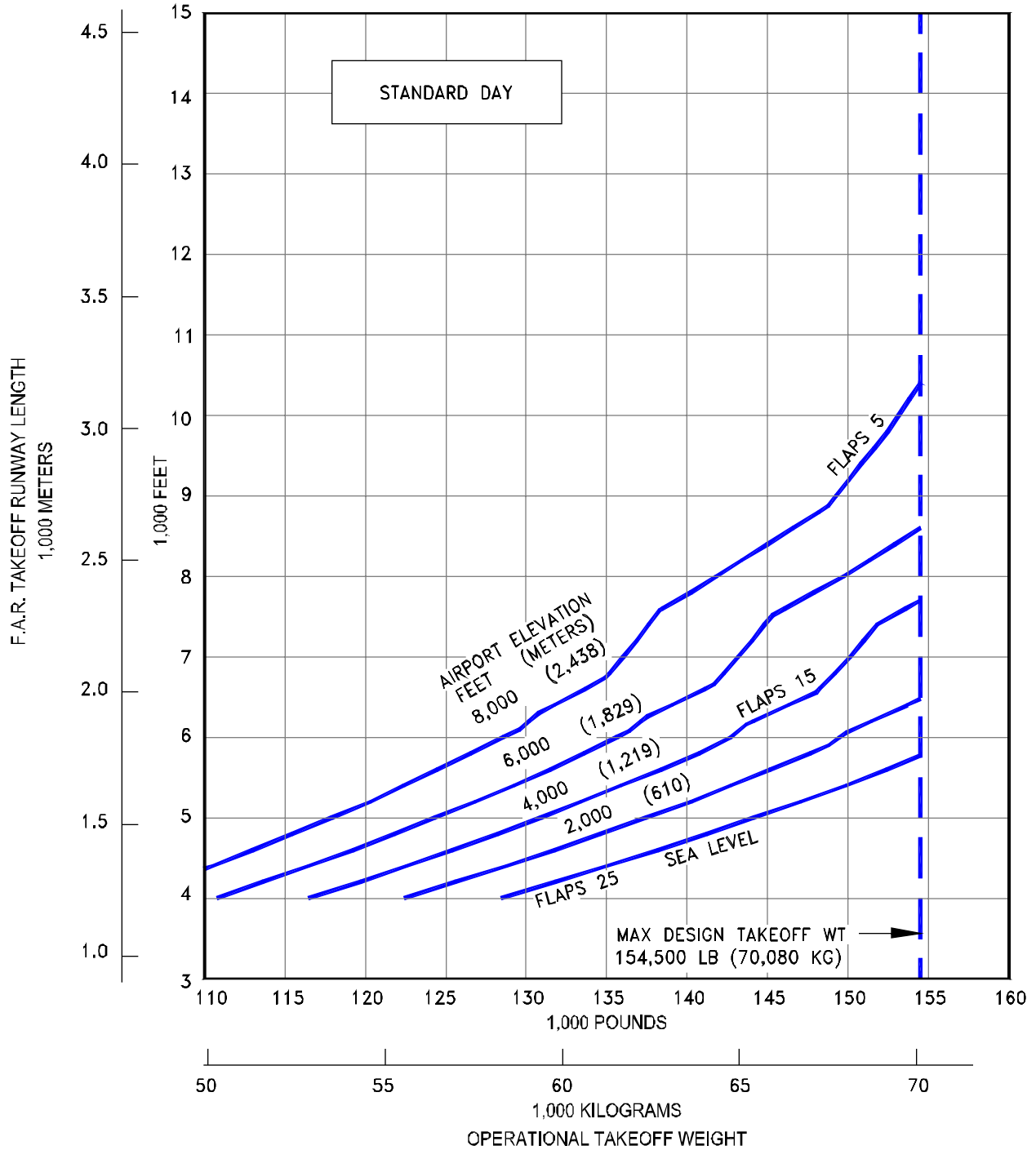

**3.3.59 F.A.R. TAKEOFF RUNWAY LENGTH REQUIREMENTS
STANDARD DAY, DRY RUNWAY**

MODEL 737-700 WITH WINGLETS (CFM56-7B24B1 ENGINES AT 24,200 LB SLST)

NOTES:

- CFM56-7B24B1 ENGINES RATED AT 24,200 LB SLST
- NO ENGINE AIR BLEED FOR AIR CONDITIONING
- ZERO WIND, ZERO RUNWAY GRADIENT
- DRY RUNWAY SURFACE
- CONSULT WITH USING AIRLINE FOR SPECIFIC OPERATING PROCEDURE PRIOR TO FACILITY DESIGN

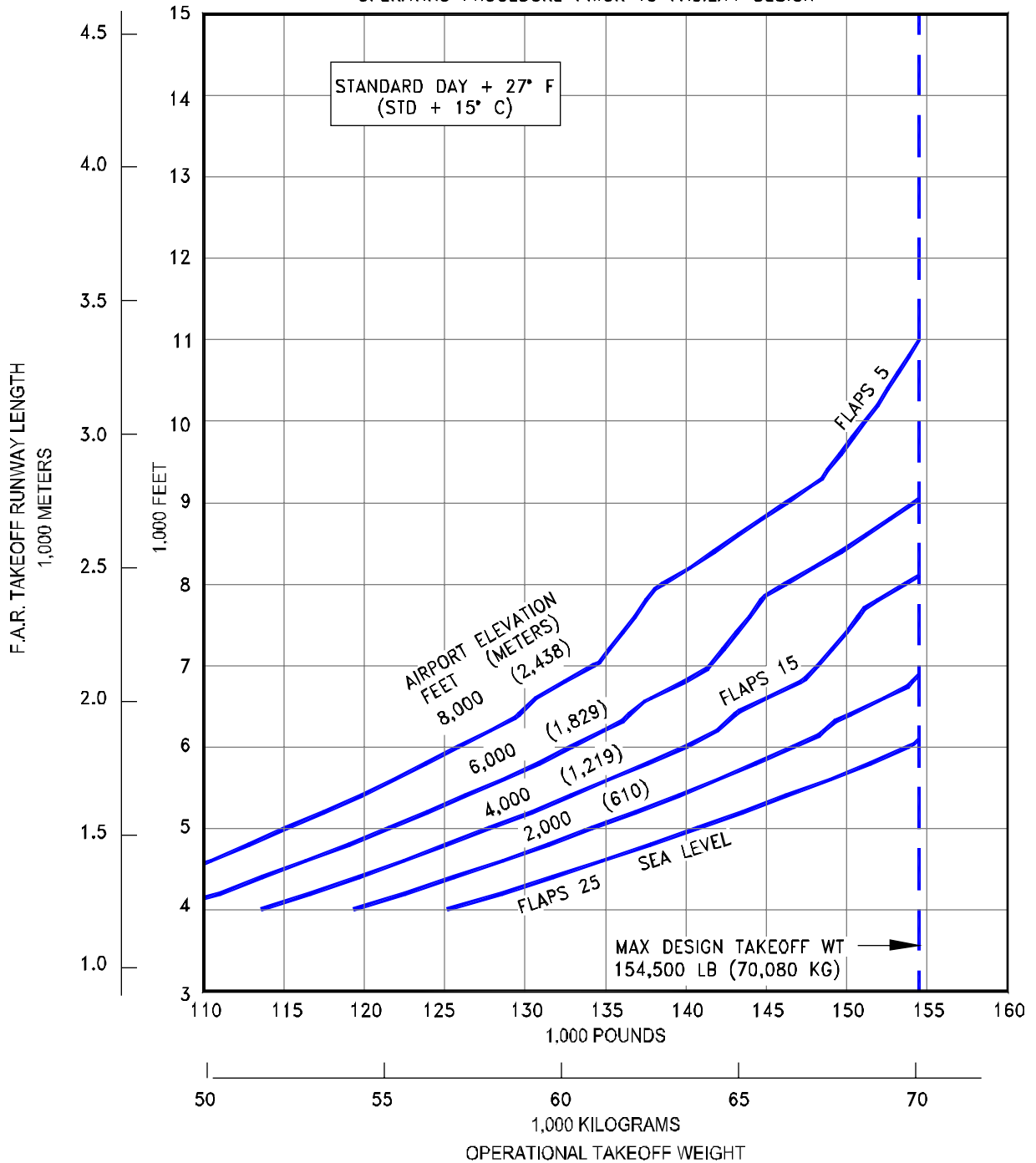

3.3.60 F.A.R. TAKEOFF RUNWAY LENGTH REQUIREMENTS

STANDARD DAY +27°F (STD + 15°C), DRY RUNWAY

MODEL 737-700 WITH WINGLETS (CFM56-7B24B1 ENGINES AT 24,200 LB SLST)

NOTES:

- CFM56-7B24B1 ENGINES RATED AT 24,200 LB SLST
- NO ENGINE AIR BLEED FOR AIR CONDITIONING
- ZERO WIND, ZERO RUNWAY GRADIENT
- WET SMOOTH RUNWAY SURFACE
- CONSULT WITH USING AIRLINE FOR SPECIFIC OPERATING PROCEDURE PRIOR TO FACILITY DESIGN
- TAKEOFF PERFORMANCE IMPROVEMENTS ARE POSSIBLE USING GROOVED RUNWAY

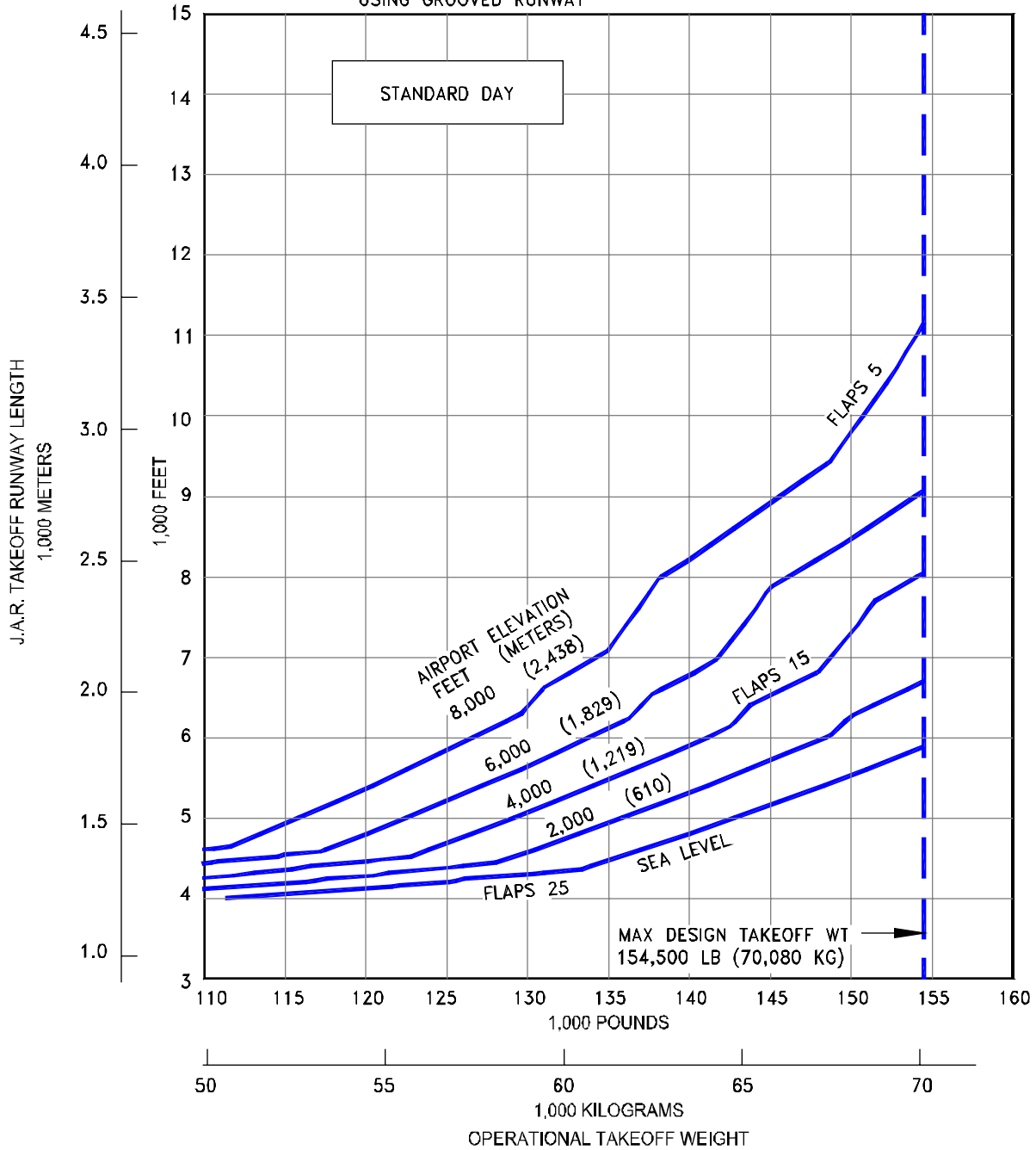

3.3.61 J.A.R. TAKEOFF RUNWAY LENGTH REQUIREMENTS

STANDARD DAY, WET RUNWAY

MODEL 737-700 WITH WINGLETS, (CFM56-7B24B1 ENGINES AT 24,200 LB SLST)

D6-58325-6

NOTES:

- ◆ CFM56-7B24B1 ENGINES RATED AT 24,200 LB SLST
- ◆ NO ENGINE AIR BLEED FOR AIR CONDITIONING
- ◆ ZERO WIND, ZERO RUNWAY GRADIENT
- ◆ WET SMOOTH RUNWAY SURFACE
- ◆ CONSULT WITH USING AIRLINE FOR SPECIFIC OPERATING PROCEDURE PRIOR TO FACILITY DESIGN
- ◆ TAKEOFF PERFORMANCE IMPROVEMENTS ARE POSSIBLE USING GROOVED RUNWAY

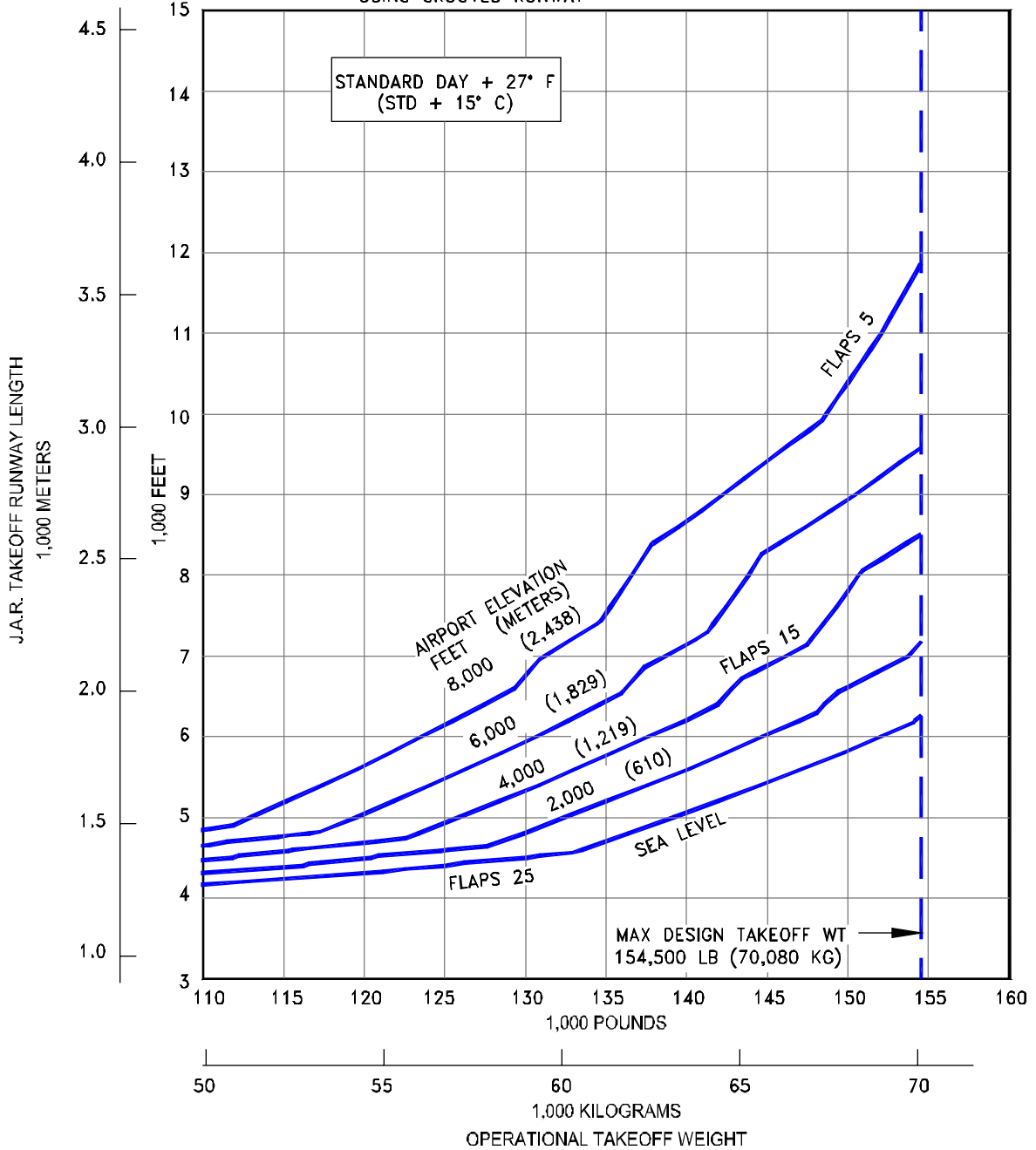

3.3.62 J.A.R. TAKEOFF RUNWAY LENGTH REQUIREMENTS

STANDARD DAY +27°F (STD + 15°C), WET RUNWAY

MODEL 737-700 WITH WINGLETS, (CFM56-7B24B1 ENGINES AT 24,200 LB SLST)

NOTES:

- CFM56-7B26 ENGINES RATED AT 26,300 LB SLST
- NO ENGINE AIR BLEED FOR AIR CONDITIONING
- ZERO WIND, ZERO RUNWAY GRADIENT
- DRY RUNWAY SURFACE
- CONSULT WITH USING AIRLINE FOR SPECIFIC OPERATING PROCEDURE PRIOR TO FACILITY DESIGN

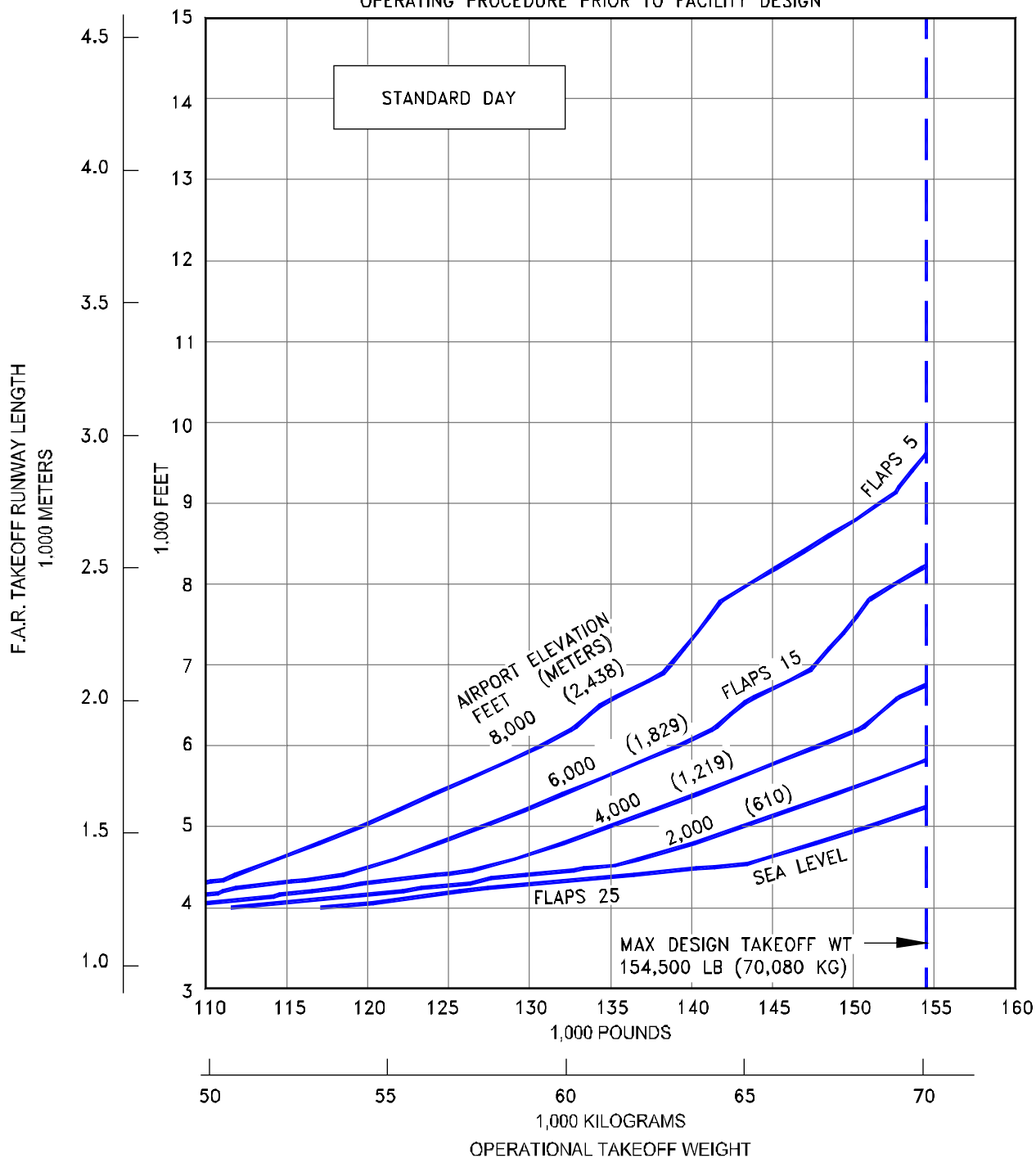

**3.3.63 F.A.R. TAKEOFF RUNWAY LENGTH REQUIREMENTS
STANDARD DAY, DRY RUNWAY**

MODEL 737-700 WITH WINGLETS (CFM56-7B26 ENGINES AT 26,300 LB SLST)

NOTES:

- CFM56-7B26 ENGINES RATED AT 26,300 LB SLST
- NO ENGINE AIR BLEED FOR AIR CONDITIONING
- ZERO WIND, ZERO RUNWAY GRADIENT
- DRY RUNWAY SURFACE
- CONSULT WITH USING AIRLINE FOR SPECIFIC OPERATING PROCEDURE PRIOR TO FACILITY DESIGN

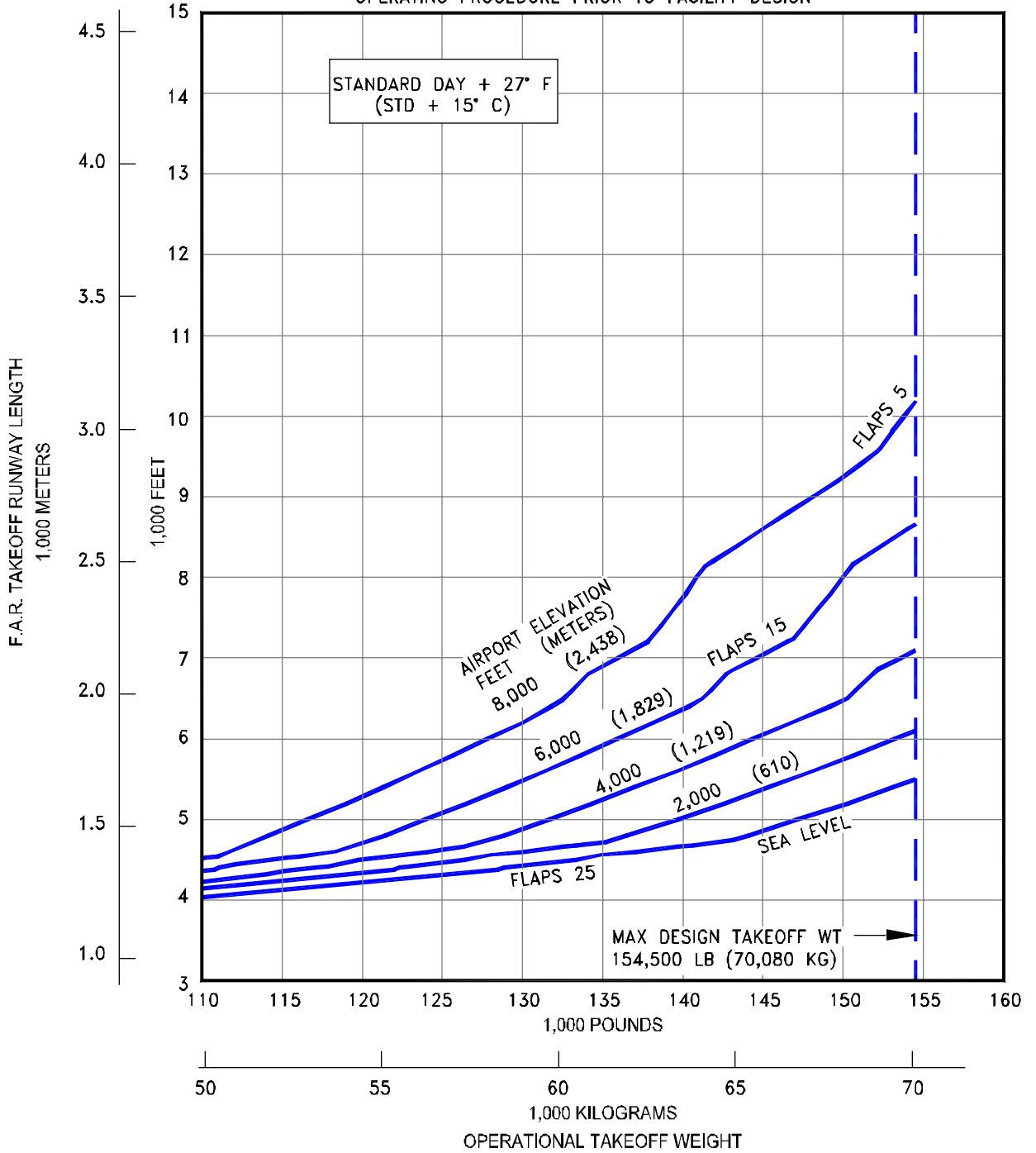

3.3.64 F.A.R. TAKEOFF RUNWAY LENGTH REQUIREMENTS

STANDARD DAY +27°F (STD + 15°C), DRY RUNWAY

MODEL 737-700 WITH WINGLETS (CFM56-7B26 ENGINES AT 26,300 LB SLST)

NOTES:

- CFM56-7B26 ENGINES RATED AT 26,300 LB SLST
- NO ENGINE AIR BLEED FOR AIR CONDITIONING
- ZERO WIND, ZERO RUNWAY GRADIENT
- WET SMOOTH RUNWAY SURFACE
- CONSULT WITH USING AIRLINE FOR SPECIFIC OPERATING PROCEDURE PRIOR TO FACILITY DESIGN
- TAKEOFF PERFORMANCE IMPROVEMENTS ARE POSSIBLE USING GROOVED RUNWAY

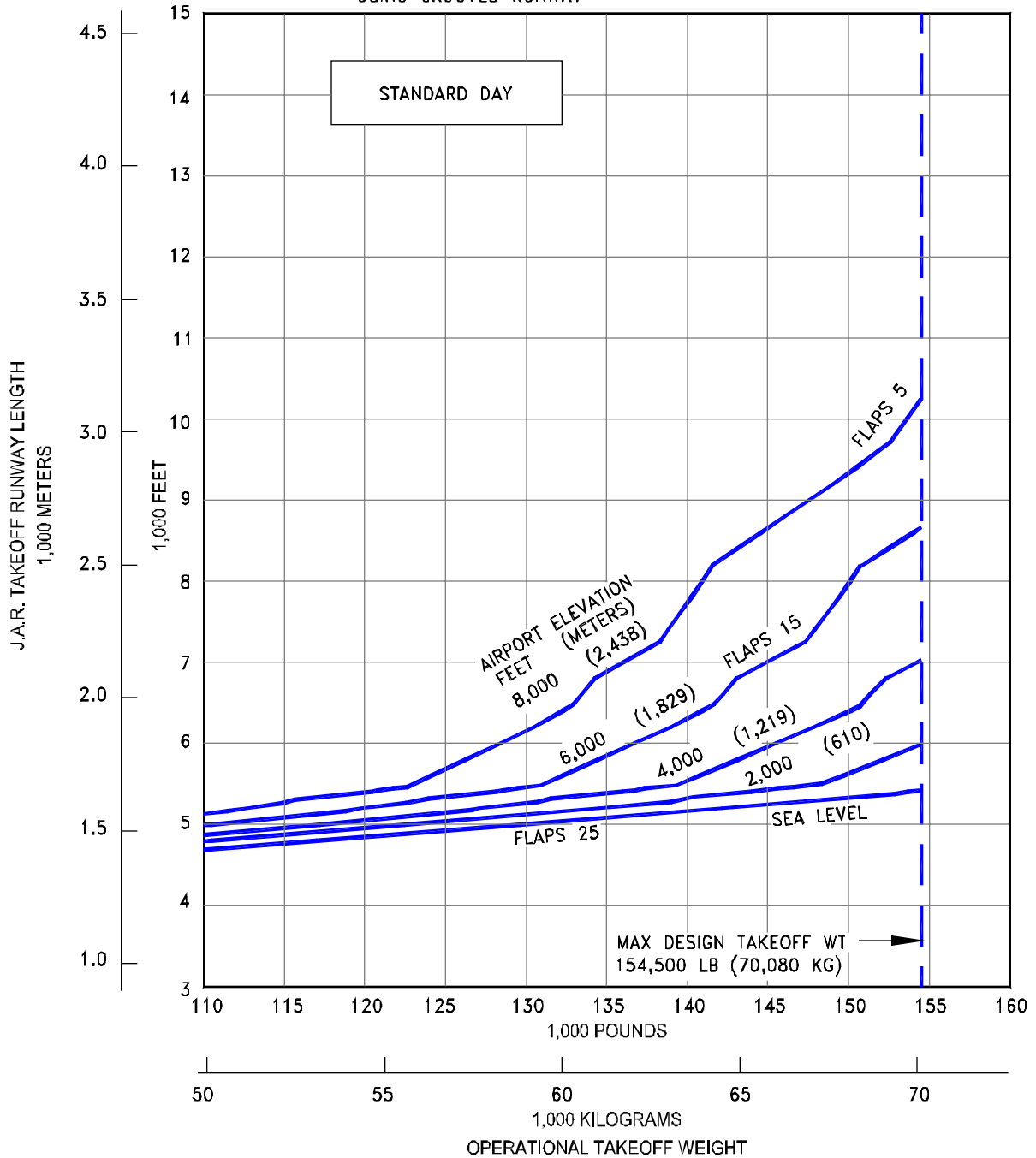

3.3.65 J.A.R. TAKEOFF RUNWAY LENGTH REQUIREMENTS

STANDARD DAY, WET RUNWAY

MODEL 737-700 WITH WINGLETS (CFM56-7B26 ENGINES AT 26,300 LB SLST)

NOTES:

- CFM56-7B26 ENGINES RATED AT 26,300 LB SLST
- NO ENGINE AIR BLEED FOR AIR CONDITIONING
- ZERO WIND, ZERO RUNWAY GRADIENT
- WET SMOOTH RUNWAY SURFACE
- CONSULT WITH USING AIRLINE FOR SPECIFIC OPERATING PROCEDURE PRIOR TO FACILITY DESIGN
- TAKEOFF PERFORMANCE IMPROVEMENTS ARE POSSIBLE USING GROOVED RUNWAY

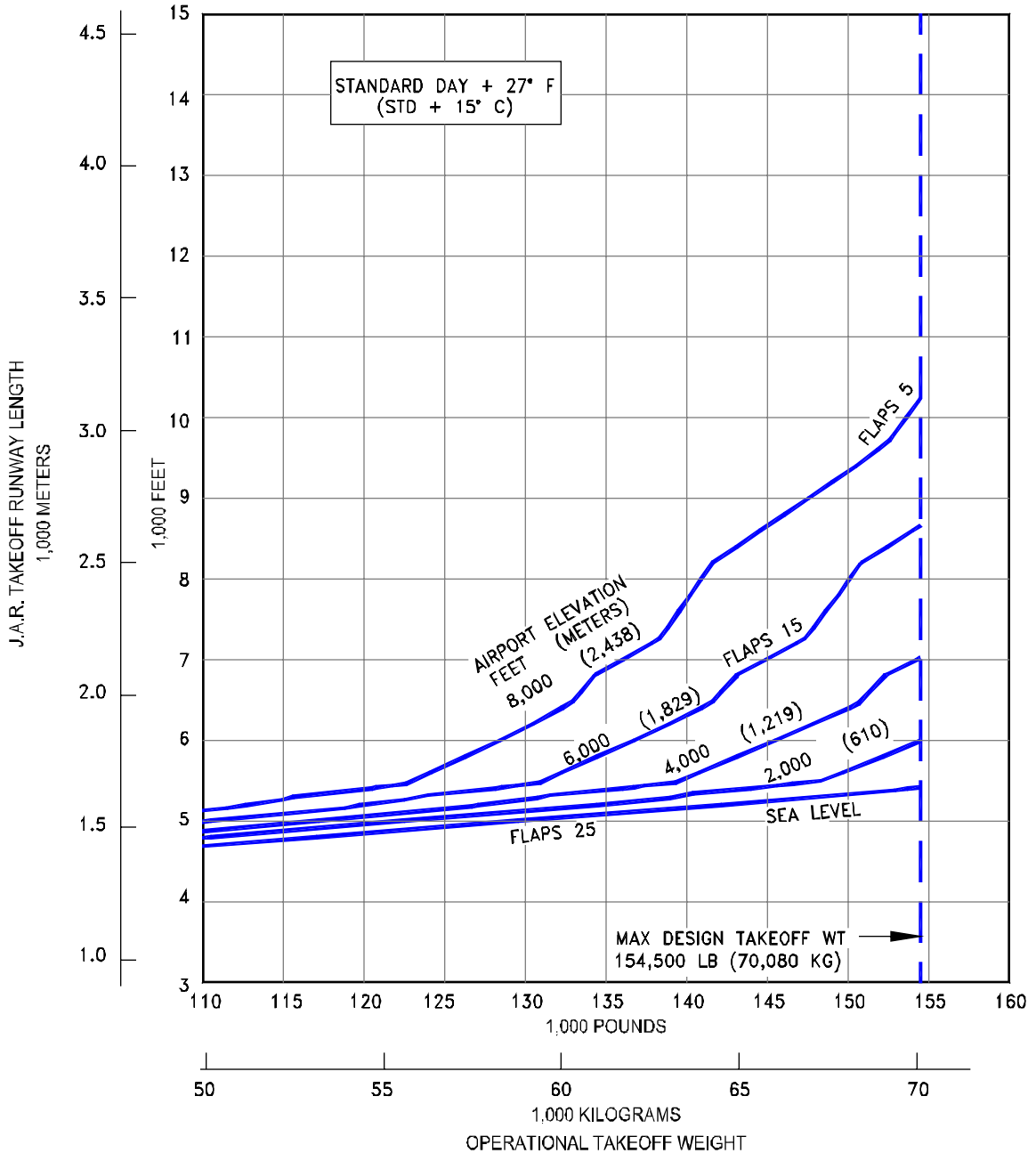

3.3.66 J.A.R. TAKEOFF RUNWAY LENGTH REQUIREMENTS

STANDARD DAY +27°F (STD + 15°C), WET RUNWAY

MODEL 737-700 WITH WINGLETS (CFM56-7B26 ENGINES AT 26,300 LB SLST)

NOTES:

- CFM56-7B27 ENGINES AT 24,200 LB SLST
- NO ENGINE AIR BLEED FOR AIR CONDITIONING
- ZERO WIND, ZERO RUNWAY GRADIENT
- DRY RUNWAY SURFACE
- CONSULT WITH AIRCRAFT USER FOR SPECIFIC OPERATING PROCEDURE PRIOR TO FACILITY DESIGN

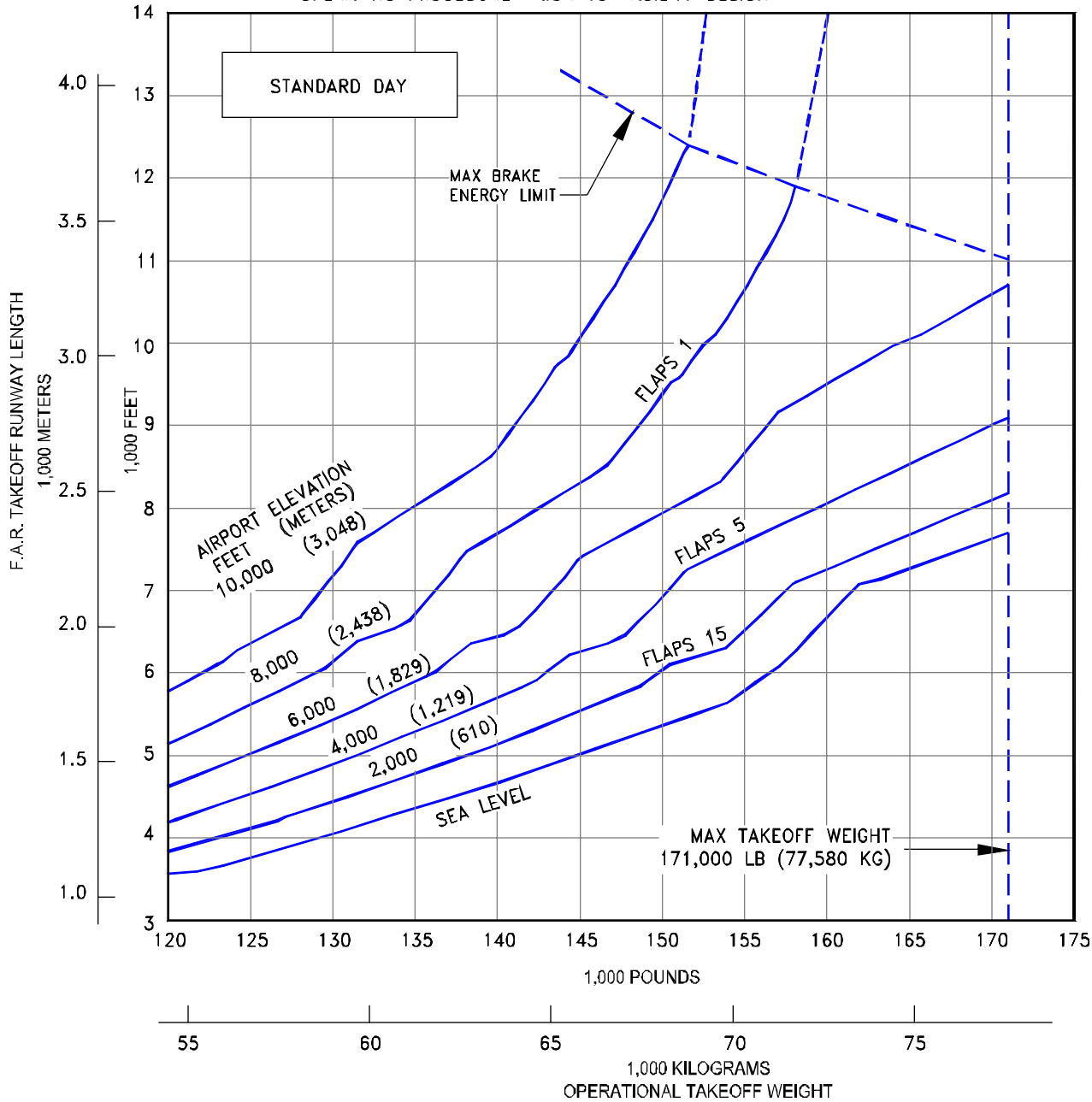

**3.3.67 F.A.R TAKEOFF RUNWAY LENGTH REQUIREMENTS - STANDARD DAY
 DRY RUNWAY**

MODEL 737 BBJ (CFM56-7B27 ENGINES AT 24,200 LB SLST)

NOTES:

- CFM56-7B27 ENGINES AT 24,200 LB SLST
- NO ENGINE AIR BLEED FOR AIR CONDITIONING
- ZERO WIND, ZERO RUNWAY GRADIENT
- DRY RUNWAY SURFACE
- CONSULT WITH AIRCRAFT USER FOR SPECIFIC OPERATING PROCEDURE PRIOR TO FACILITY DESIGN

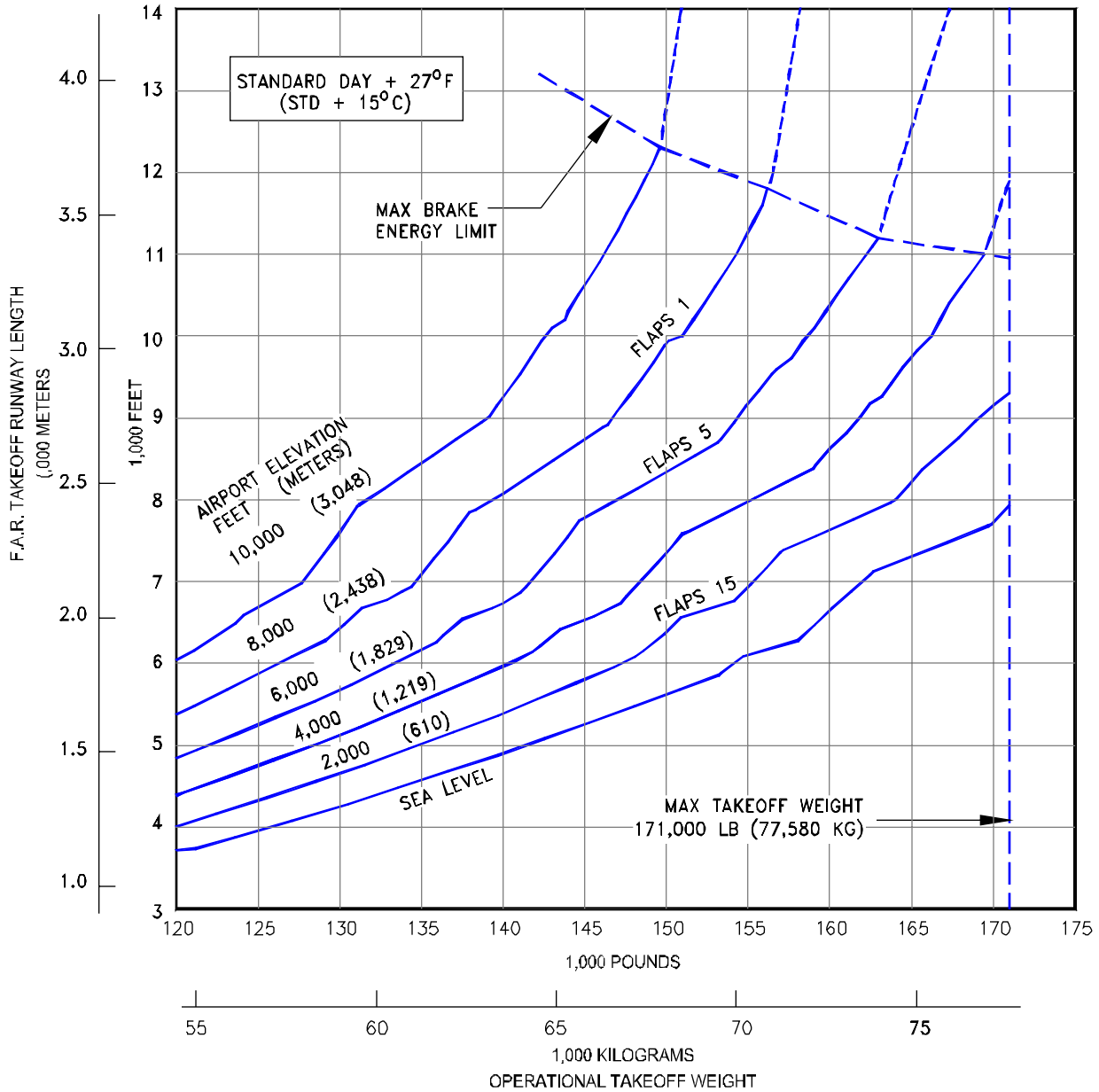

3.3.68 F.A.R TAKEOFF RUNWAY LENGTH REQUIREMENTS
STANDARD DAY +27°F (STD + 15°C), DRY RUNWAY
MODEL 737 BBJ (CFM56-7B27 ENGINES AT 24,200 LB SLST)

NOTES:

- CFM56-7B27 ENGINES AT 24,200 LB SLST
- NO ENGINE AIR BLEED FOR AIR CONDITIONING
- ZERO WIND, ZERO RUNWAY GRADIENT
- WET SMOOTH RUNWAY
- CONSULT WITH AIRCRAFT USER FOR SPECIFIC OPERATING PROCEDURE PRIOR TO FACILITY DESIGN
- TAKEOFF PERFORMANCE IMPROVEMENTS ARE POSSIBLE USING GROOVED RUNWAY

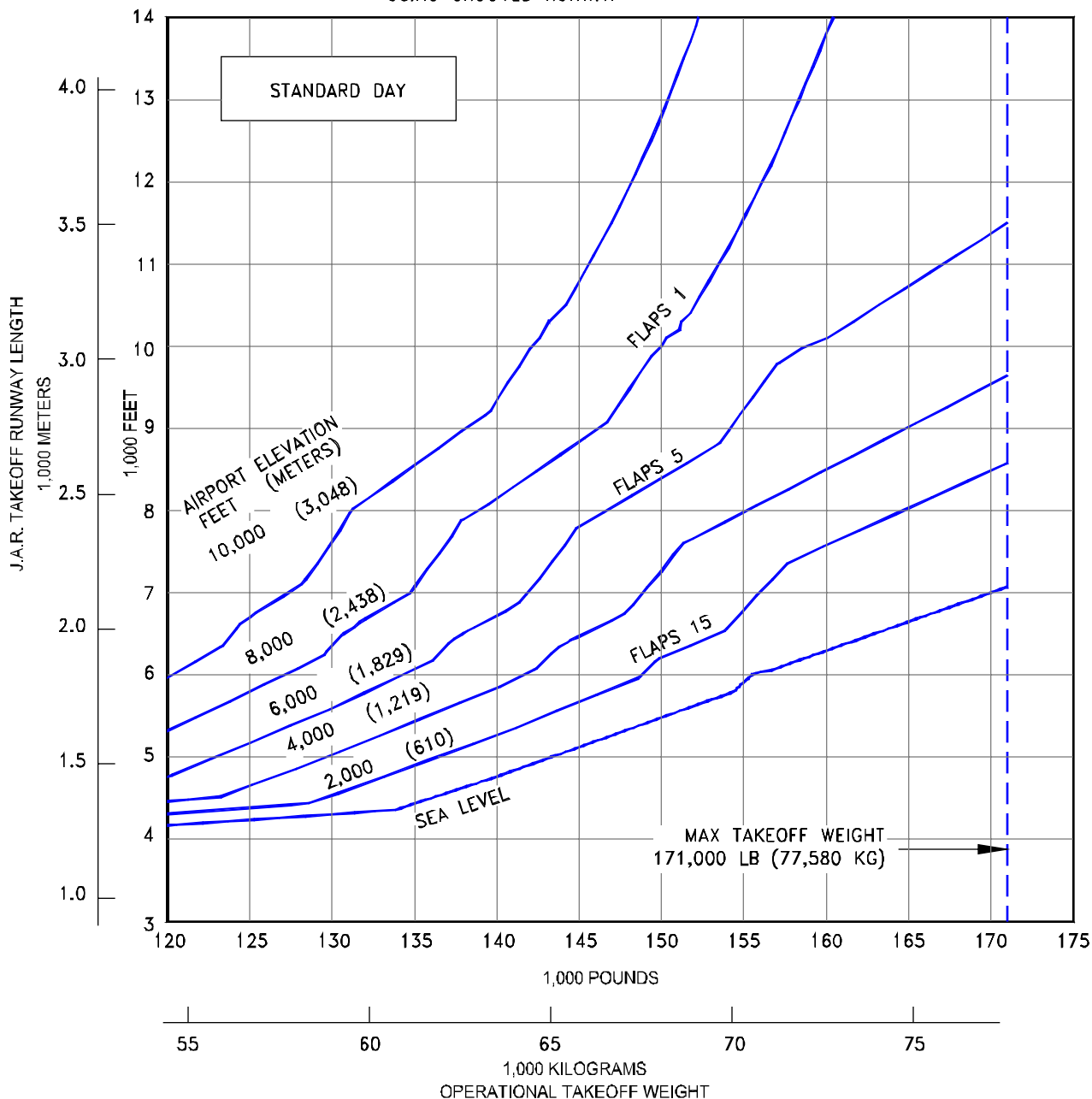

3.3.69 J.A.R TAKEOFF RUNWAY LENGTH REQUIREMENTS - STANDARD DAY WET RUNWAY

MODEL 737 BBJ (CFM56-7B27 ENGINES AT 24,200 LB SLST)

NOTES:

- CFM56-7B27 ENGINES AT 24,200 LB SLST
- NO ENGINE AIR BLEED FOR AIR CONDITIONING
- ZERO WIND, ZERO RUNWAY GRADIENT
- WET SMOOTH RUNWAY
- CONSULT WITH AIRCRAFT USER FOR SPECIFIC OPERATING PROCEDURE PRIOR TO FACILITY DESIGN
- TAKEOFF PERFORMANCE IMPROVEMENTS ARE POSSIBLE USING GROOVED RUNWAY

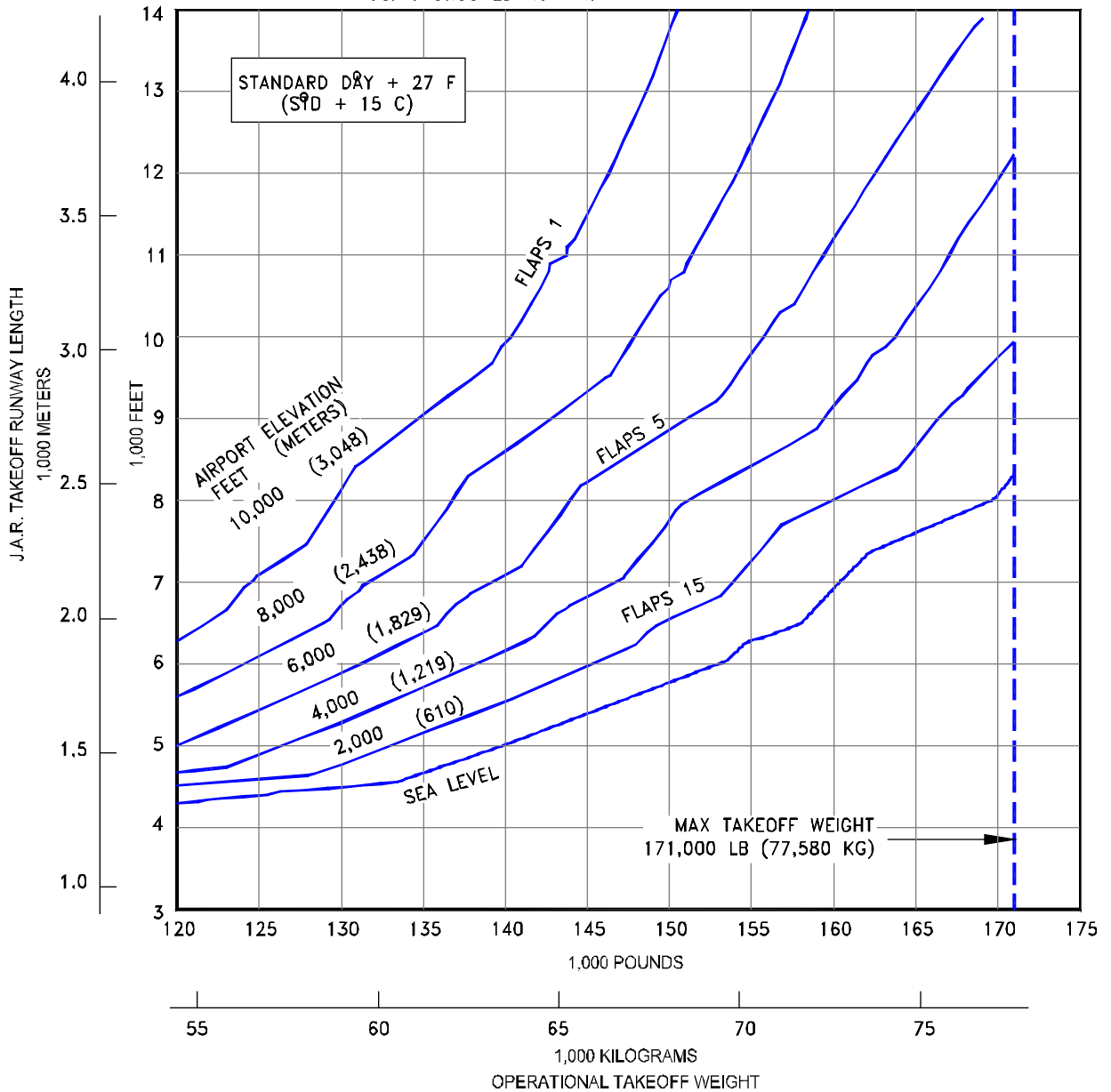

3.3.70 J.A.R TAKEOFF RUNWAY LENGTH REQUIREMENTS

STANDARD DAY +27°F (STD + 15°C), WET RUNWAY

MODEL 737 BBJ (CFM56-7B27 ENGINES AT 24,200 LB SLST)

NOTES:

- CFM56-7B27 ENGINES AT 26,300 LB SLST
- NO ENGINE AIR BLEED FOR AIR CONDITIONING
- ZERO WIND, ZERO RUNWAY GRADIENT
- DRY RUNWAY SURFACE
- CONSULT WITH AIRCRAFT USER FOR SPECIFIC OPERATING PROCEDURE PRIOR TO FACILITY DESIGN

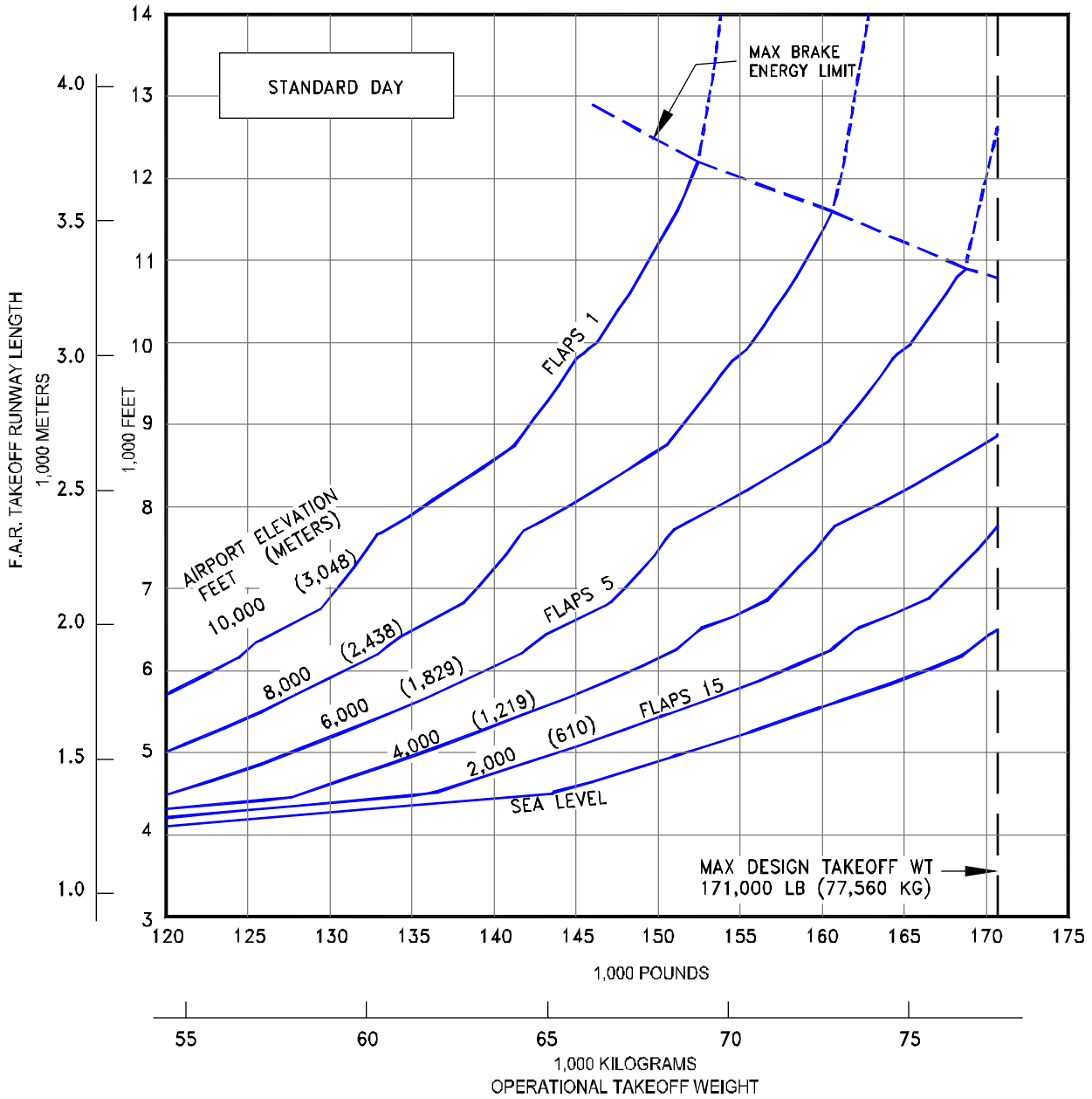

**3.3.71 F.A.R TAKEOFF RUNWAY LENGTH REQUIREMENTS - STANDARD DAY
DRY RUNWAY**

MODEL 737 BBJ (CFM56-7B27 ENGINES AT 26,300 LB SLST)

NOTES:

- CFM56-7B27 ENGINES AT 26,300 LB SLST
- NO ENGINE AIR BLEED FOR AIR CONDITIONING
- ZERO WIND, ZERO RUNWAY GRADIENT
- DRY RUNWAY SURFACE
- CONSULT WITH AIRCRAFT USER FOR SPECIFIC OPERATING PROCEDURE PRIOR TO FACILITY DESIGN

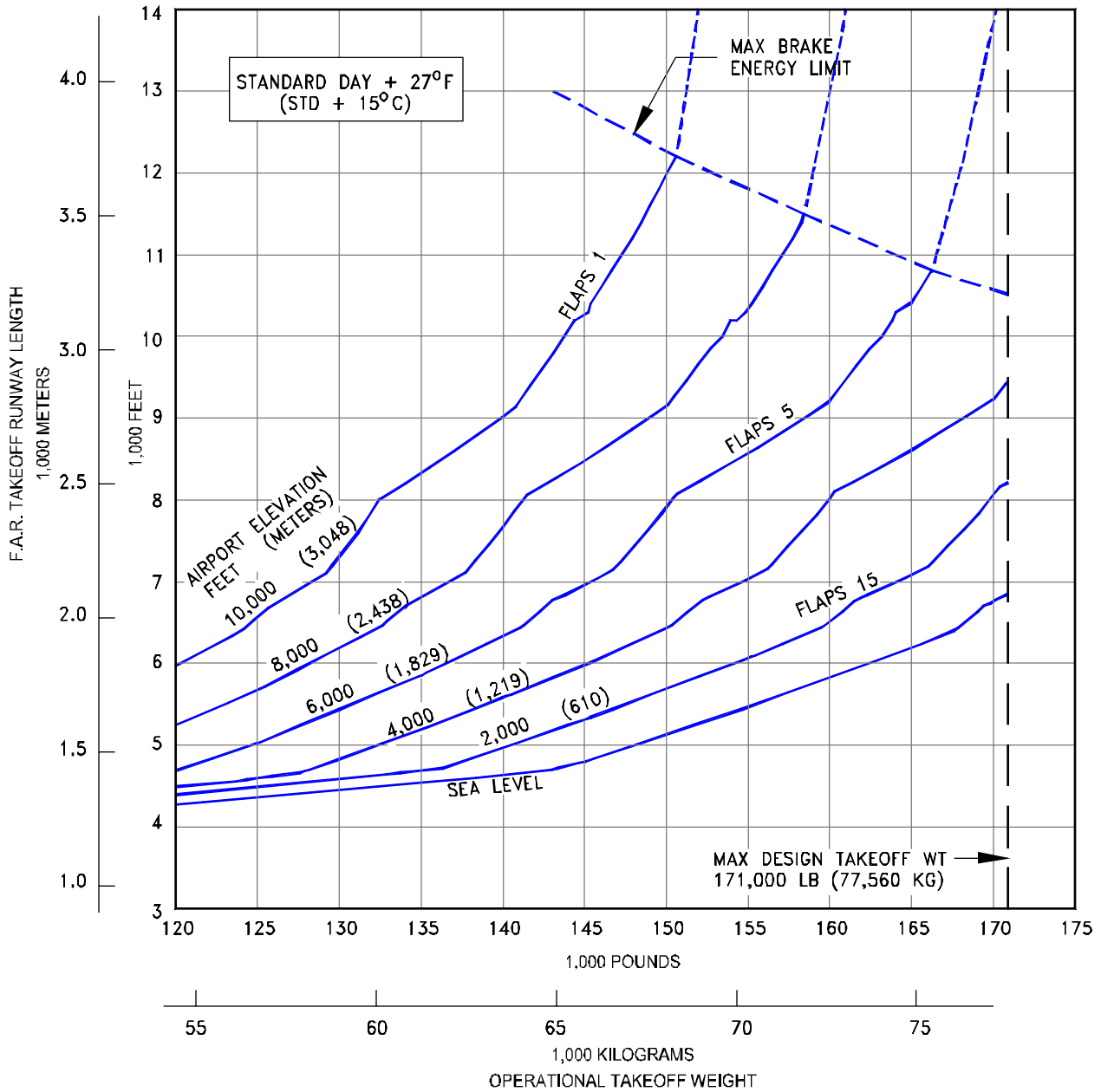

3.3.72 F.A.R TAKEOFF RUNWAY LENGTH REQUIREMENTS

STANDARD DAY +27°F (STD + 15°C), DRY RUNWAY

MODEL 737 BBJ (CFM56-7B27 ENGINES AT 26,300 LB SLST)

NOTES:

- CFM56-7B27 ENGINES AT 26,300 LB SLST
- NO ENGINE AIR BLEED FOR AIR CONDITIONING
- ZERO WIND, ZERO RUNWAY GRADIENT
- WET SMOOTH RUNWAY
- CONSULT WITH AIRCRAFT USER FOR SPECIFIC OPERATING PROCEDURE PRIOR TO FACILITY DESIGN
- TAKEOFF PERFORMANCE IMPROVEMENTS ARE POSSIBLE USING GROOVED RUNWAY

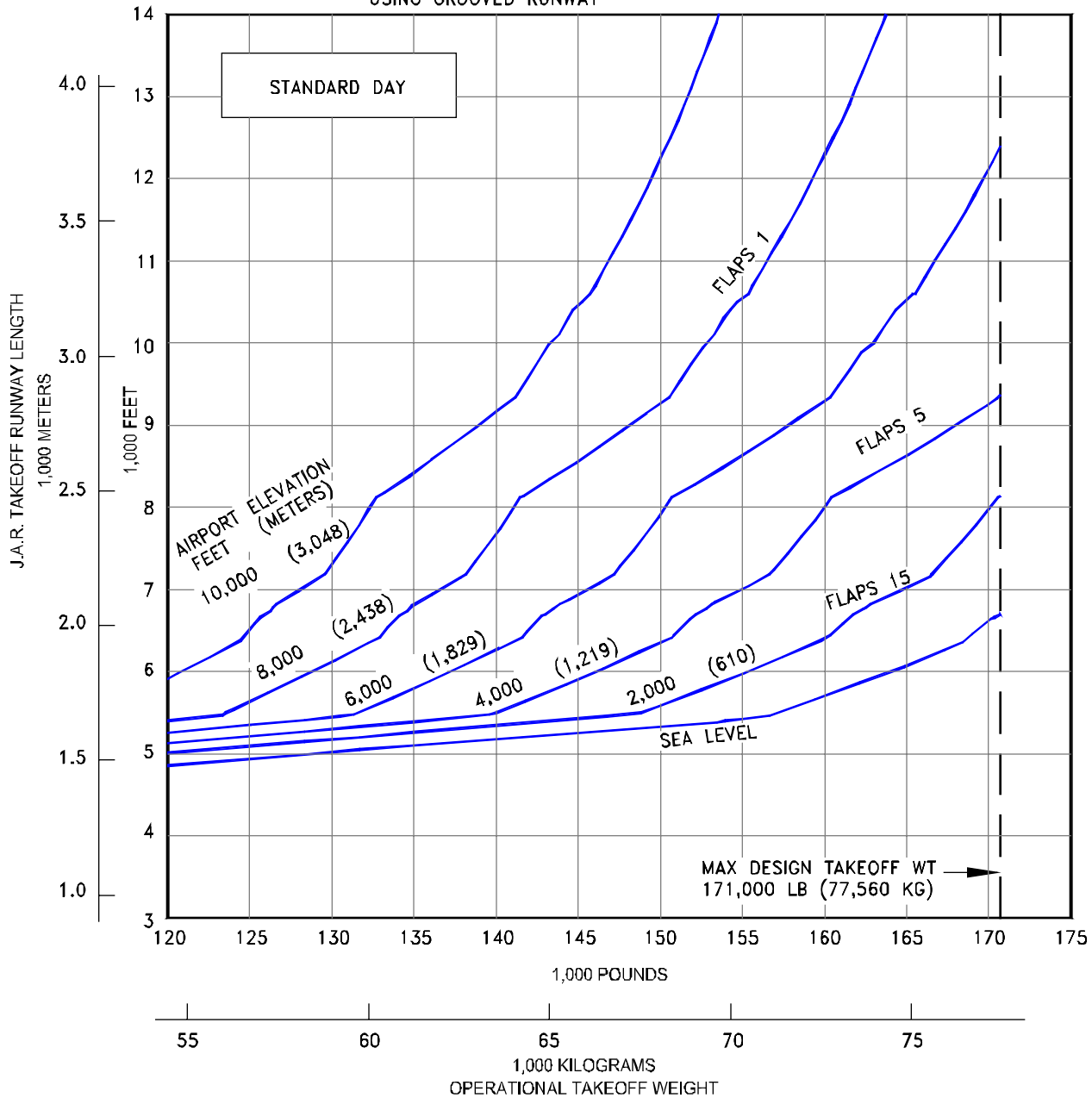

3.3.73 J.A.R TAKEOFF RUNWAY LENGTH REQUIREMENTS - STANDARD DAY WET RUNWAY

MODEL 737 BBJ (CFM56-7B27 ENGINES AT 26,300 LB SLST)

- NOTES:
- CFM56-7B27 ENGINES AT 26,300 LB SLST
 - NO ENGINE AIR BLEED FOR AIR CONDITIONING
 - ZERO WIND, ZERO RUNWAY GRADIENT
 - WET SMOOTH RUNWAY SURFACE
 - CONSULT WITH AIRCRAFT USER FOR SPECIFIC OPERATING PROCEDURE PRIOR TO FACILITY DESIGN
 - TAKEOFF PERFORMANCE IMPROVEMENTS ARE POSSIBLE USING GROOVED RUNWAY

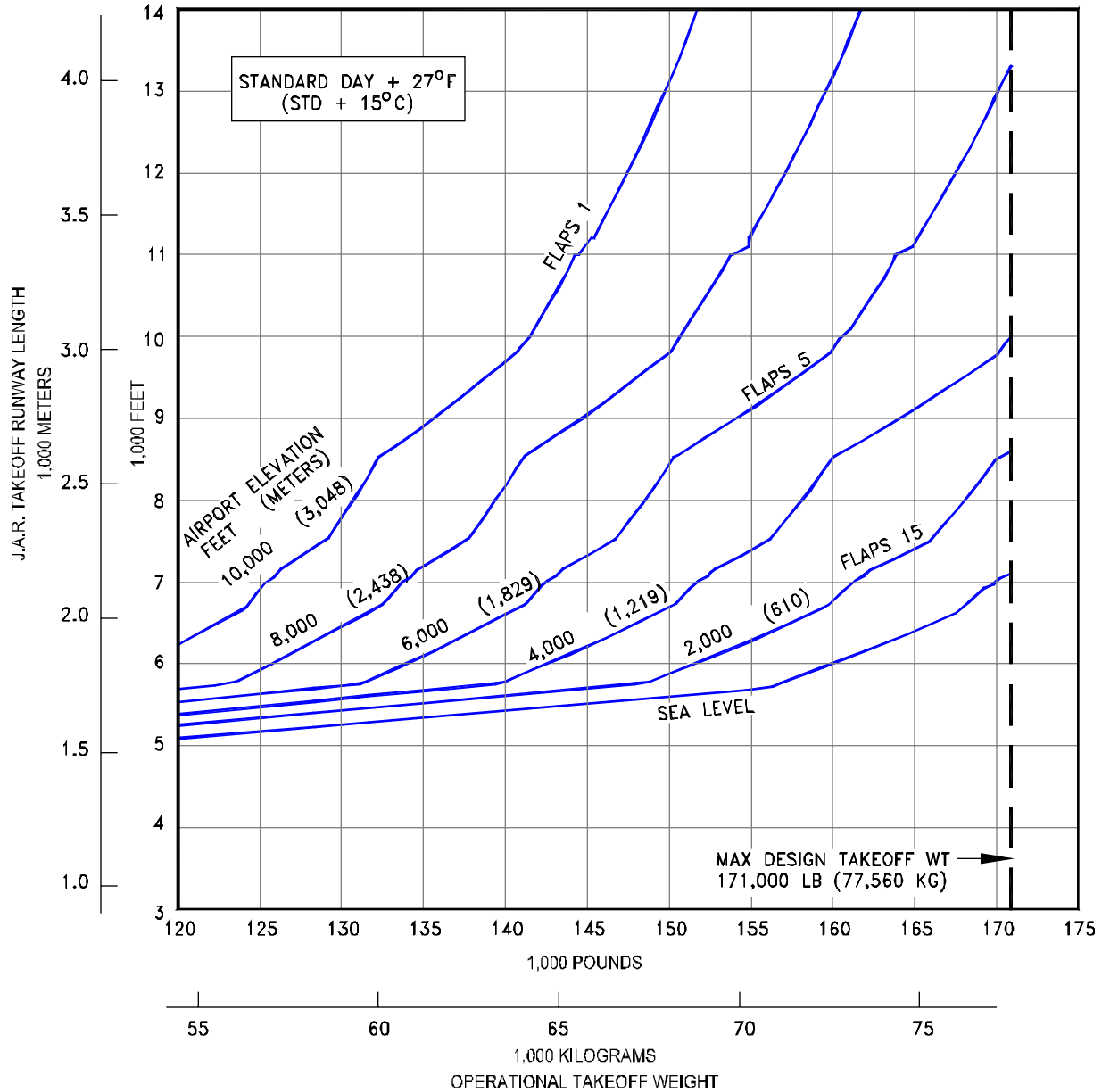

3.3.74 J.A.R TAKEOFF RUNWAY LENGTH REQUIREMENTS

STANDARD DAY +27°F (STD + 15°C), WET RUNWAY

MODEL 737 BBJ (CFM56-7B27 ENGINES AT 26,300 LB SLST)

NOTES:

- CFM56-7B27 ENGINES AT 27,300 LB SLST
- NO ENGINE AIR BLEED FOR AIR CONDITIONING
- ZERO WIND, ZERO RUNWAY GRADIENT
- DRY RUNWAY SURFACE
- CONSULT WITH AIRCRAFT USER FOR SPECIFIC OPERATING PROCEDURE PRIOR TO FACILITY DESIGN

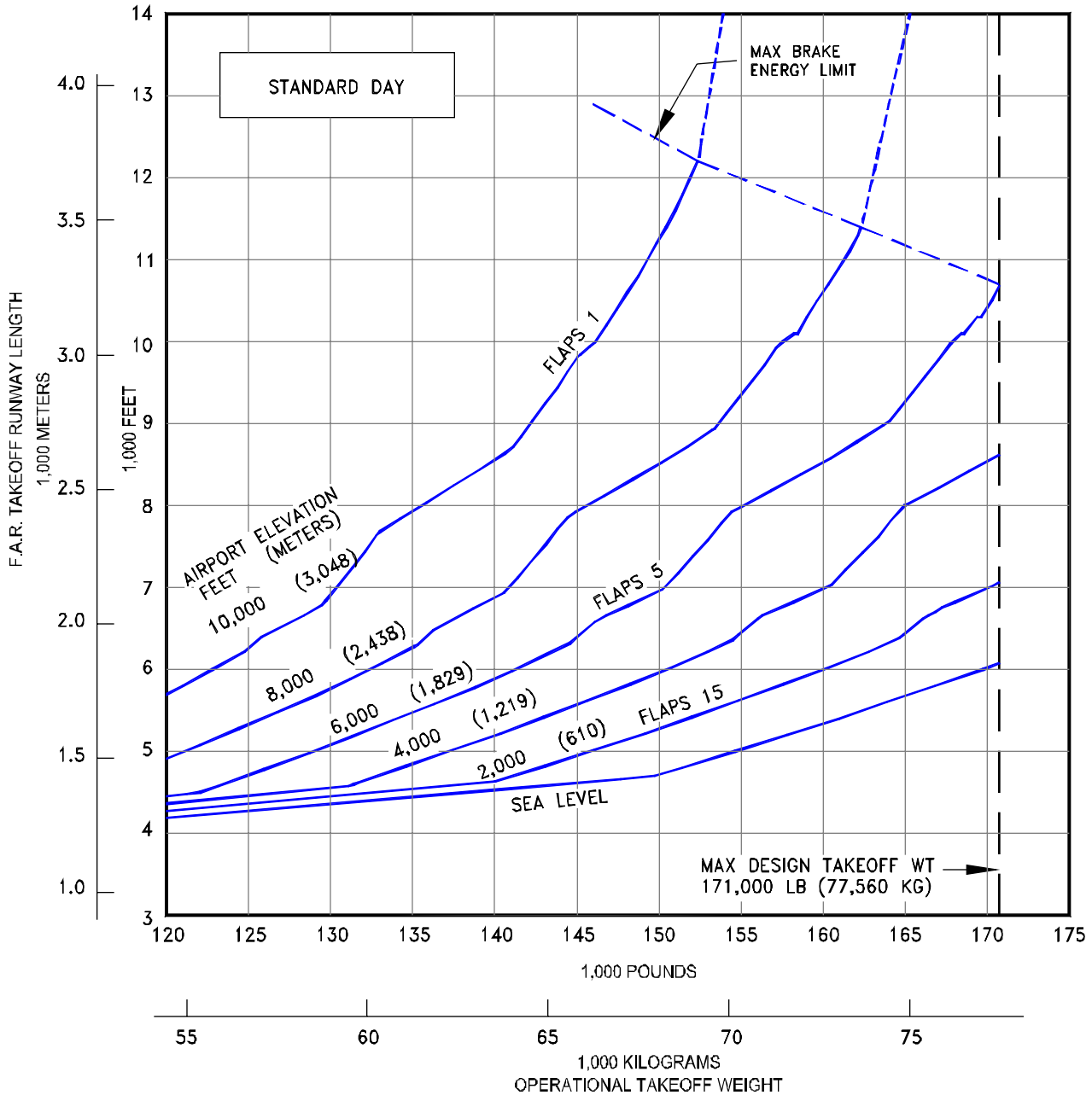

3.3.75 F.A.R TAKEOFF RUNWAY LENGTH REQUIREMENTS - STANDARD DAY DRY RUNWAY

MODEL 737 BBJ (CFM56-7B27 ENGINES AT 27,300 LB SLST)

NOTES:

- CFM56-7B27 ENGINES AT 27,300 LB SLST
- NO ENGINE AIR BLEED FOR AIR CONDITIONING
- ZERO WIND, ZERO RUNWAY GRADIENT
- DRY RUNWAY SURFACE
- CONSULT WITH AIRCRAFT USER FOR SPECIFIC OPERATING PROCEDURE PRIOR TO FACILITY DESIGN

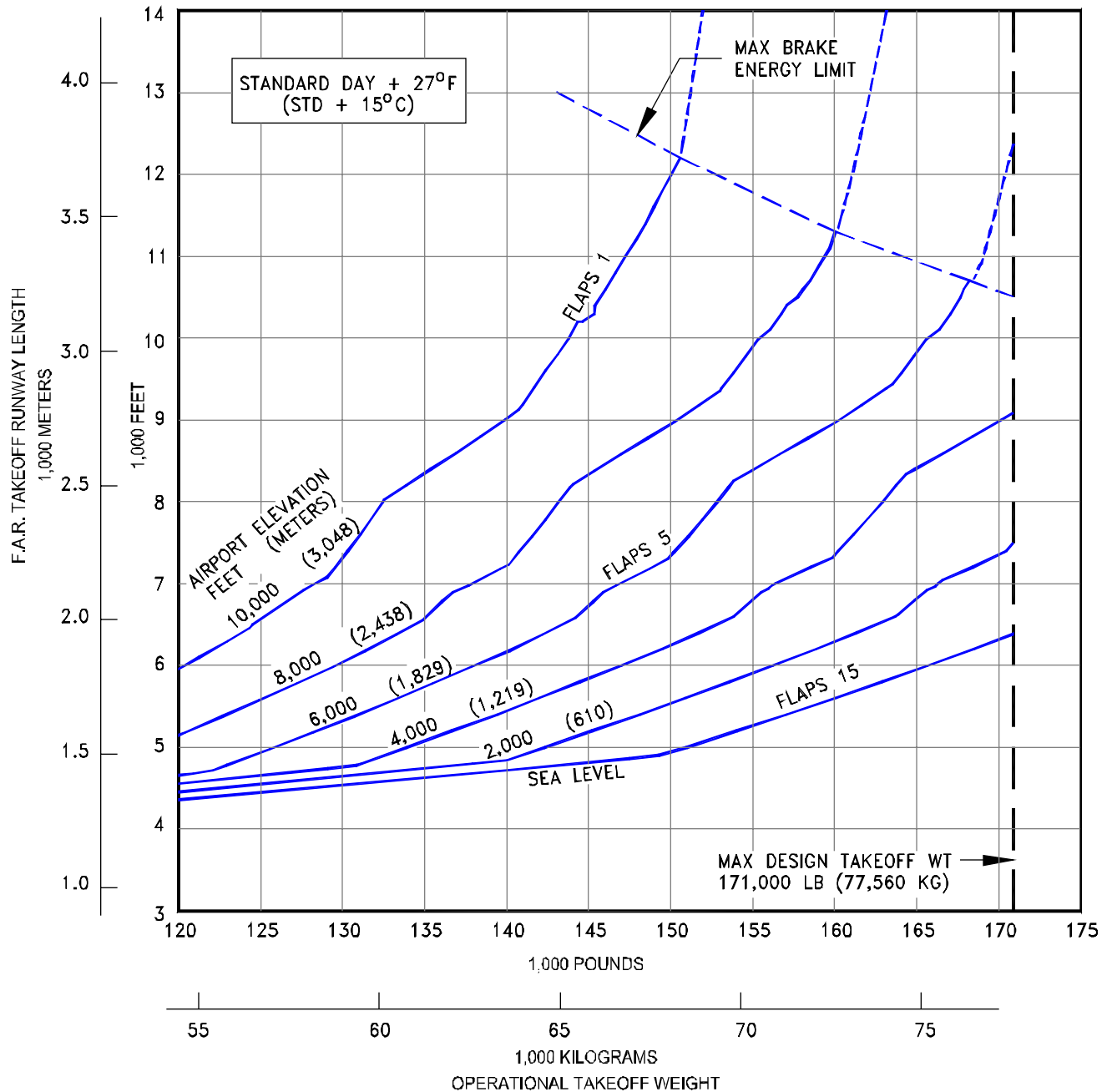

3.3.76 F.A.R TAKEOFF RUNWAY LENGTH REQUIREMENTS

STANDARD DAY +27°F (STD + 15°C), DRY RUNWAY
MODEL 737 BBJ (CFM56-7B27 ENGINES AT 27,300 LB SLST)

NOTES:

- CFM56-7B27 ENGINES AT 27,300 LB SLST
- NO ENGINE AIR BLEED FOR AIR CONDITIONING
- ZERO WIND, ZERO RUNWAY GRADIENT
- WET SMOOTH RUNWAY SURFACE
- CONSULT WITH AIRCRAFT USER FOR SPECIFIC OPERATING PROCEDURE PRIOR TO FACILITY DESIGN
- TAKEOFF PERFORMANCE IMPROVEMENTS ARE POSSIBLE USING GROOVED RUNWAY

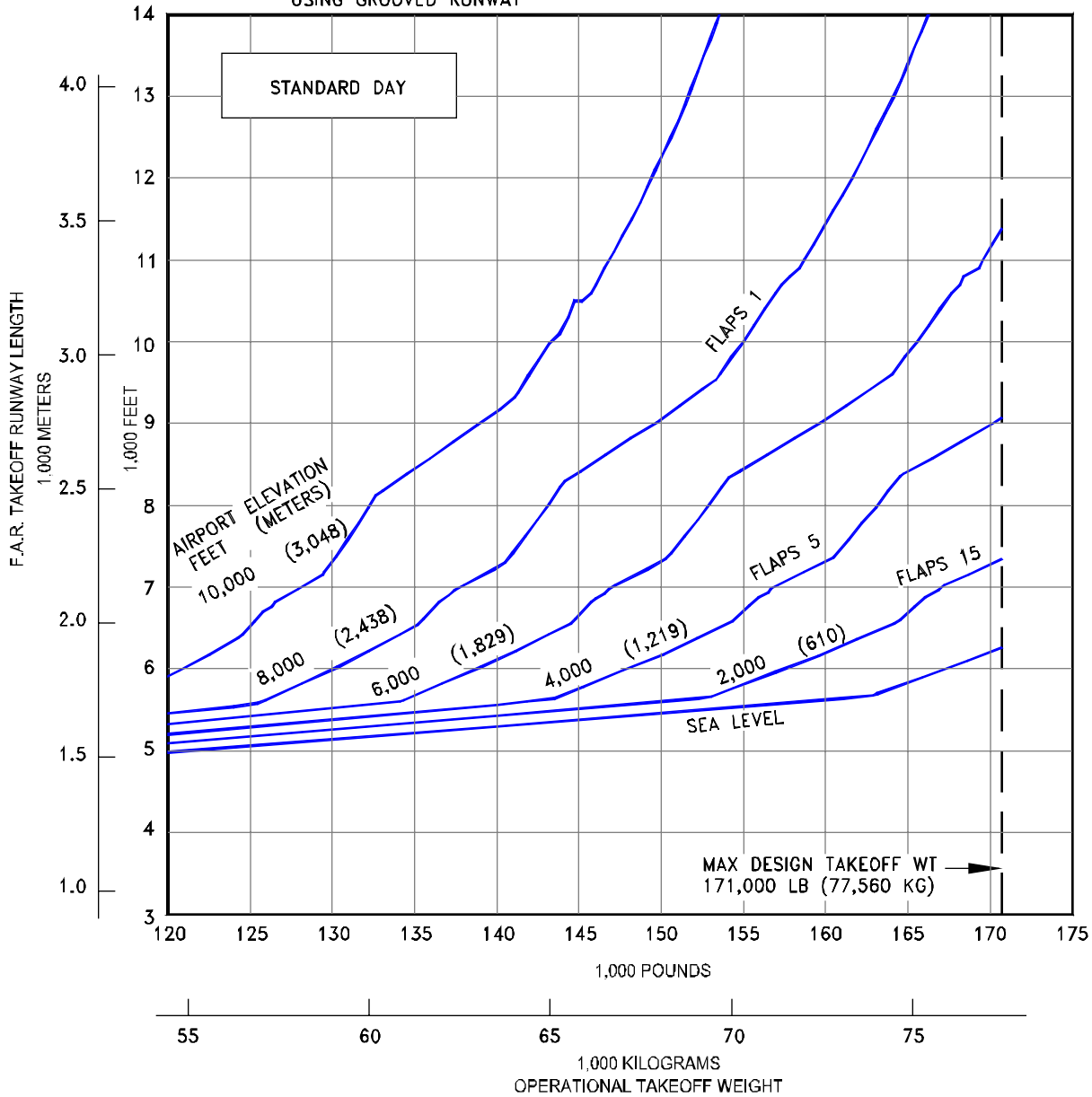

3.3.77 J.A.R TAKEOFF RUNWAY LENGTH REQUIREMENTS - STANDARD DAY WET RUNWAY

MODEL 737 BBJ (CFM56-7B27 ENGINES AT 27,300 LB SLST)

NOTES:

- CFM56-7B27 ENGINES AT 27,300 LB SLST
- NO ENGINE AIR BLEED FOR AIR CONDITIONING
- ZERO WIND, ZERO RUNWAY GRADIENT
- WET SMOOTH RUNWAY SURFACE
- CONSULT WITH AIRCRAFT USER FOR SPECIFIC OPERATING PROCEDURE PRIOR TO FACILITY DESIGN
- TAKEOFF PERFORMANCE IMPROVEMENTS ARE POSSIBLE USING GROOVED RUNWAY

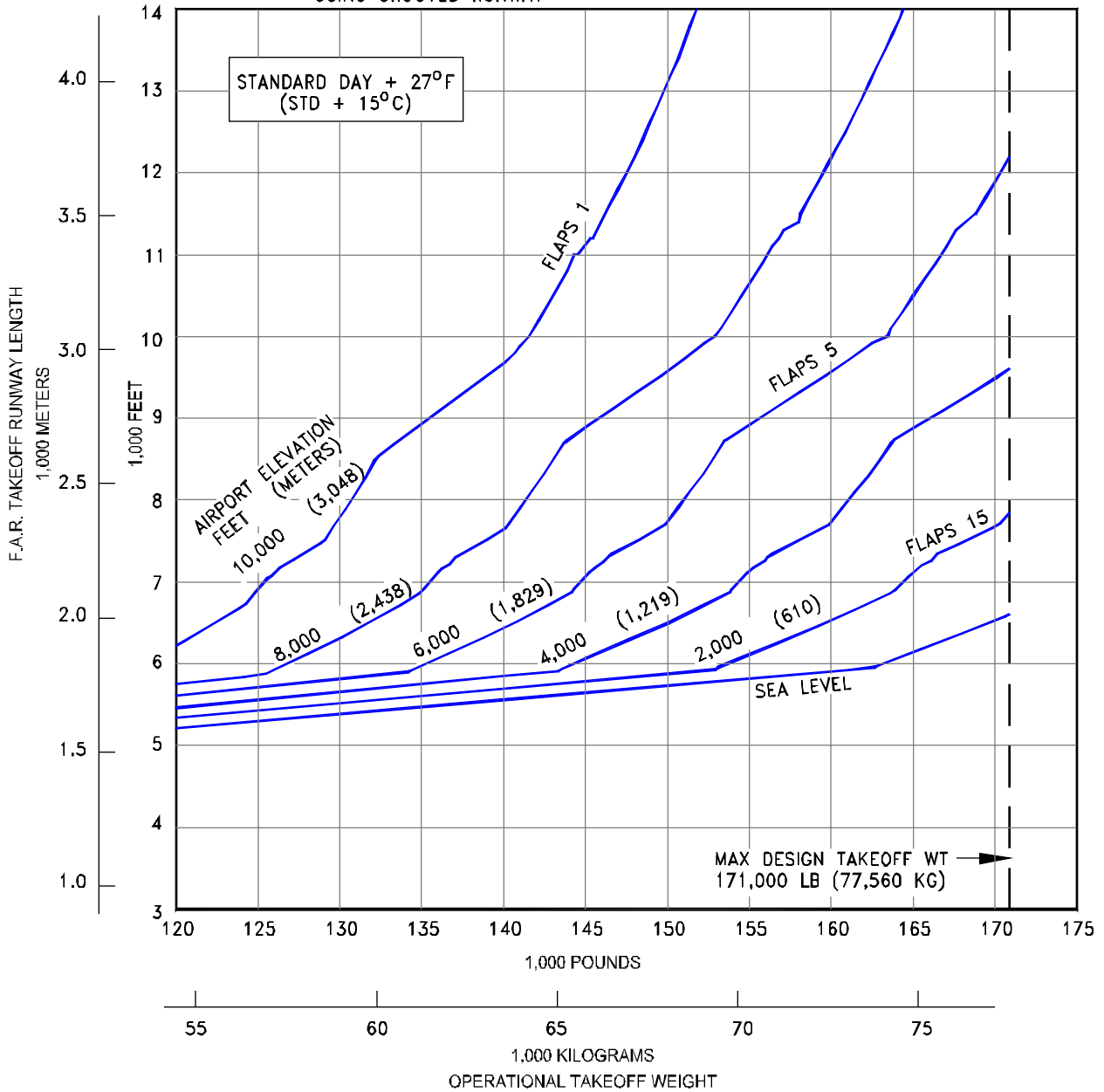

3.3.78 J.A.R TAKEOFF RUNWAY LENGTH REQUIREMENTS

STANDARD DAY +27°F (STD + 15°C), WET RUNWAY

MODEL 737 BBJ (CFM56-7B27 ENGINES AT 27,300 LB SLST)

NOTES:

- CFM56-7B24 ENGINES RATED AT 24,200 LB SLST
- NO ENGINE AIR BLEED FOR AIR CONDITIONING
- ZERO WIND, ZERO RUNWAY GRADIENT
- DRY RUNWAY SURFACE
- CONSULT WITH USING AIRLINE FOR SPECIFIC OPERATING PROCEDURE PRIOR TO FACILITY DESIGN

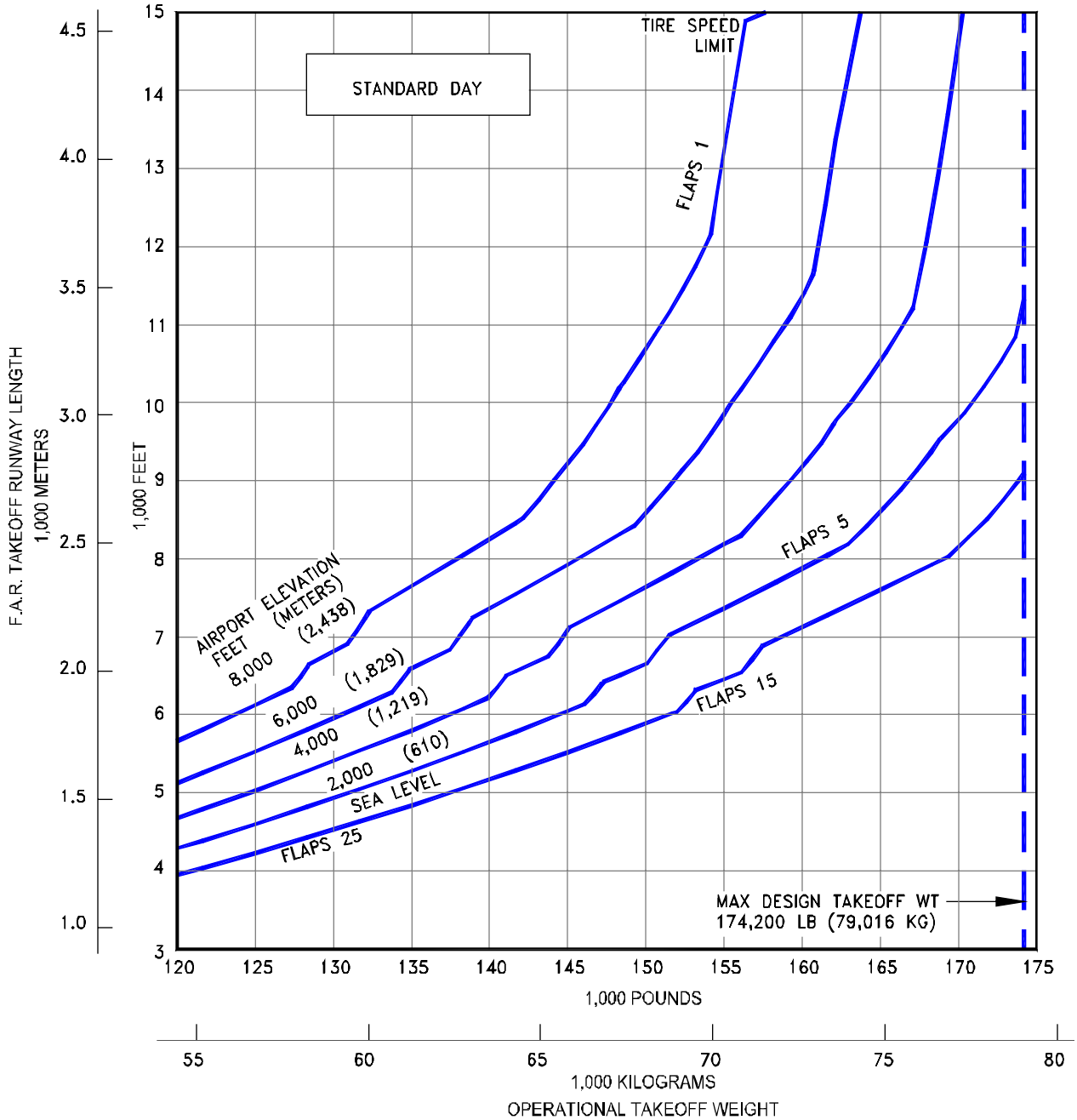

3.3.79 F.A.R. TAKEOFF RUNWAY LENGTH REQUIREMENTS
STANDARD DAY, DRY RUNWAY
MODEL 737-800 (CFM56-7B24 ENGINES AT 24,200 LB SLST)

D6-58325-6

NOTES:

- CFM56-7B24 ENGINES RATED AT 24,200 LB SLST
- NO ENGINE AIR BLEED FOR AIR CONDITIONING
- ZERO WIND, ZERO RUNWAY GRADIENT
- DRY RUNWAY SURFACE
- CONSULT WITH USING AIRLINE FOR SPECIFIC OPERATING PROCEDURE PRIOR TO FACILITY DESIGN

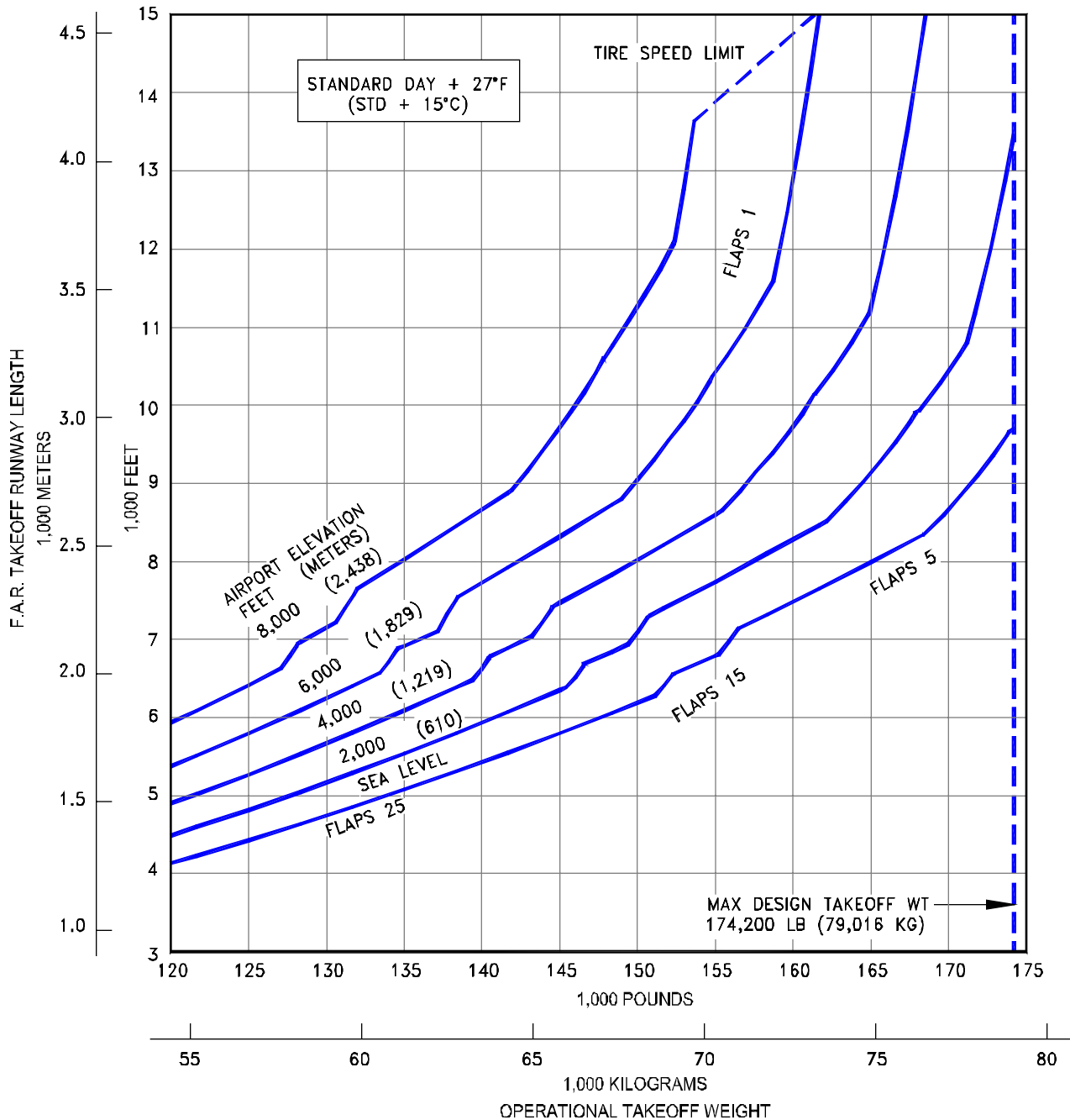

3.3.80 F.A.R. TAKEOFF RUNWAY LENGTH REQUIREMENTS

STANDARD DAY +27°F (STD + 15°C), DRY RUNWAY
MODEL 737-800 (CFM56-7B24 ENGINES AT 24,200 LB SLST)

NOTES:

- CFM56-7B24 ENGINES RATED AT 24,200 LB SLST
- NO ENGINE AIR BLEED FOR AIR CONDITIONING
- ZERO WIND, ZERO RUNWAY GRADIENT
- WET SMOOTH RUNWAY SURFACE
- CONSULT WITH USING AIRLINE FOR SPECIFIC OPERATING PROCEDURE PRIOR TO FACILITY DESIGN
- TAKEOFF PERFORMANCE IMPROVEMENTS ARE POSSIBLE USING GROOVED RUNWAY

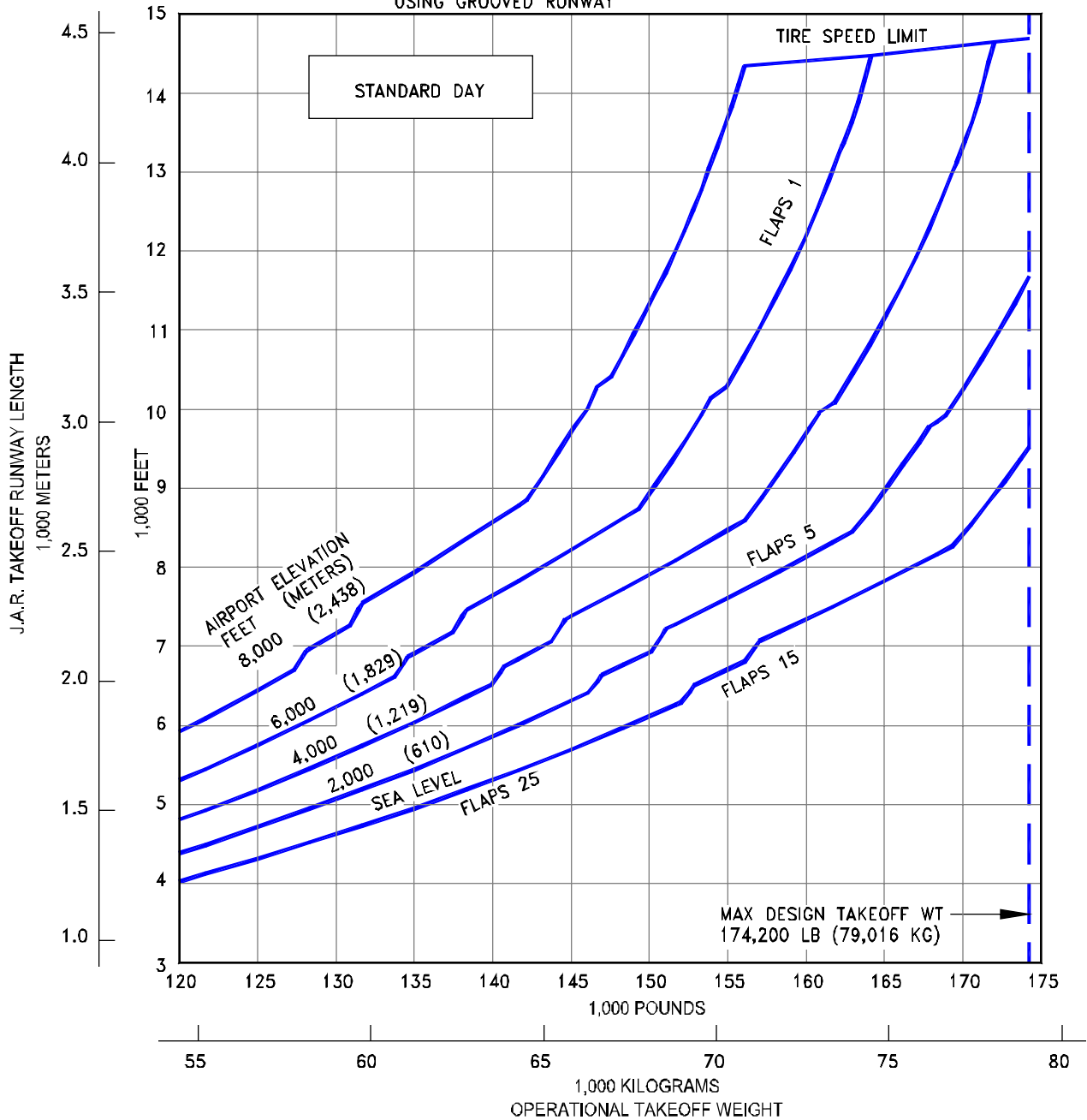

3.3.81 J.A.R. TAKEOFF RUNWAY LENGTH REQUIREMENTS
STANDARD DAY, WET RUNWAY
MODEL 737-800 (CFM56-7B24 ENGINES AT 24,200 LB SLST)

NOTES:

- CFM56-7B24 ENGINES RATED AT 24,200 LB SLST
- NO ENGINE AIR BLEED FOR AIR CONDITIONING
- ZERO WIND, ZERO RUNWAY GRADIENT
- WET SMOOTH RUNWAY SURFACE
- CONSULT WITH USING AIRLINE FOR SPECIFIC OPERATING PROCEDURE PRIOR TO FACILITY DESIGN
- TAKEOFF PERFORMANCE IMPROVEMENTS ARE POSSIBLE USING GROOVED RUNWAY

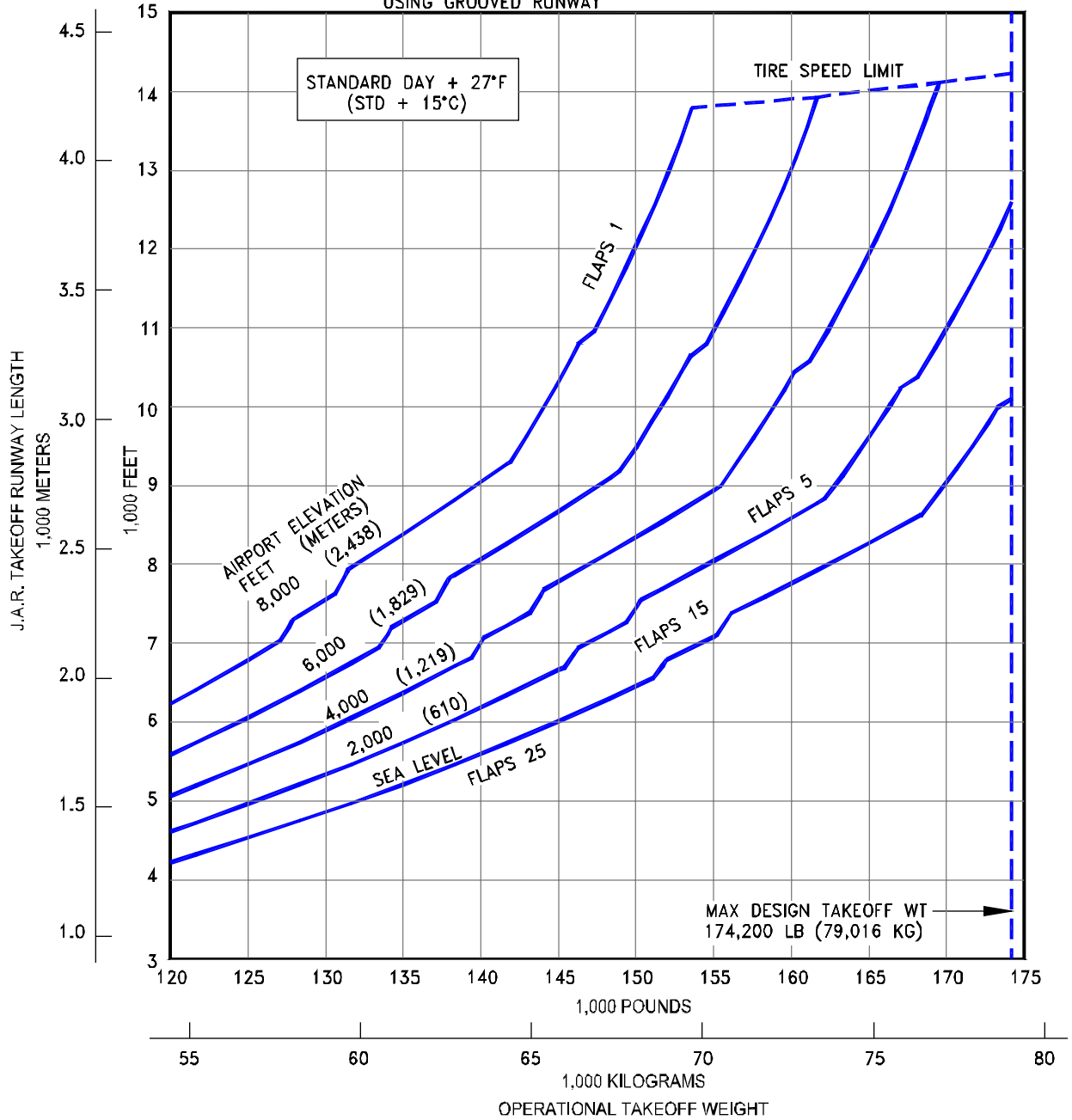

3.3.82 J.A.R. TAKEOFF RUNWAY LENGTH REQUIREMENTS
STANDARD DAY +27°F (STD + 15°C), WET RUNWAY
MODEL 737-800 (CFM56-7B24 ENGINES AT 24,200 LB SLST)

NOTES:

- CFM56-7B24 ENGINES RATED AT 24,200 LB SLST
- NO ENGINE AIR BLEED FOR AIR CONDITIONING
- ZERO WIND, ZERO RUNWAY GRADIENT
- DRY RUNWAY SURFACE
- CONSULT WITH USING AIRLINE FOR SPECIFIC OPERATING PROCEDURE PRIOR TO FACILITY DESIGN

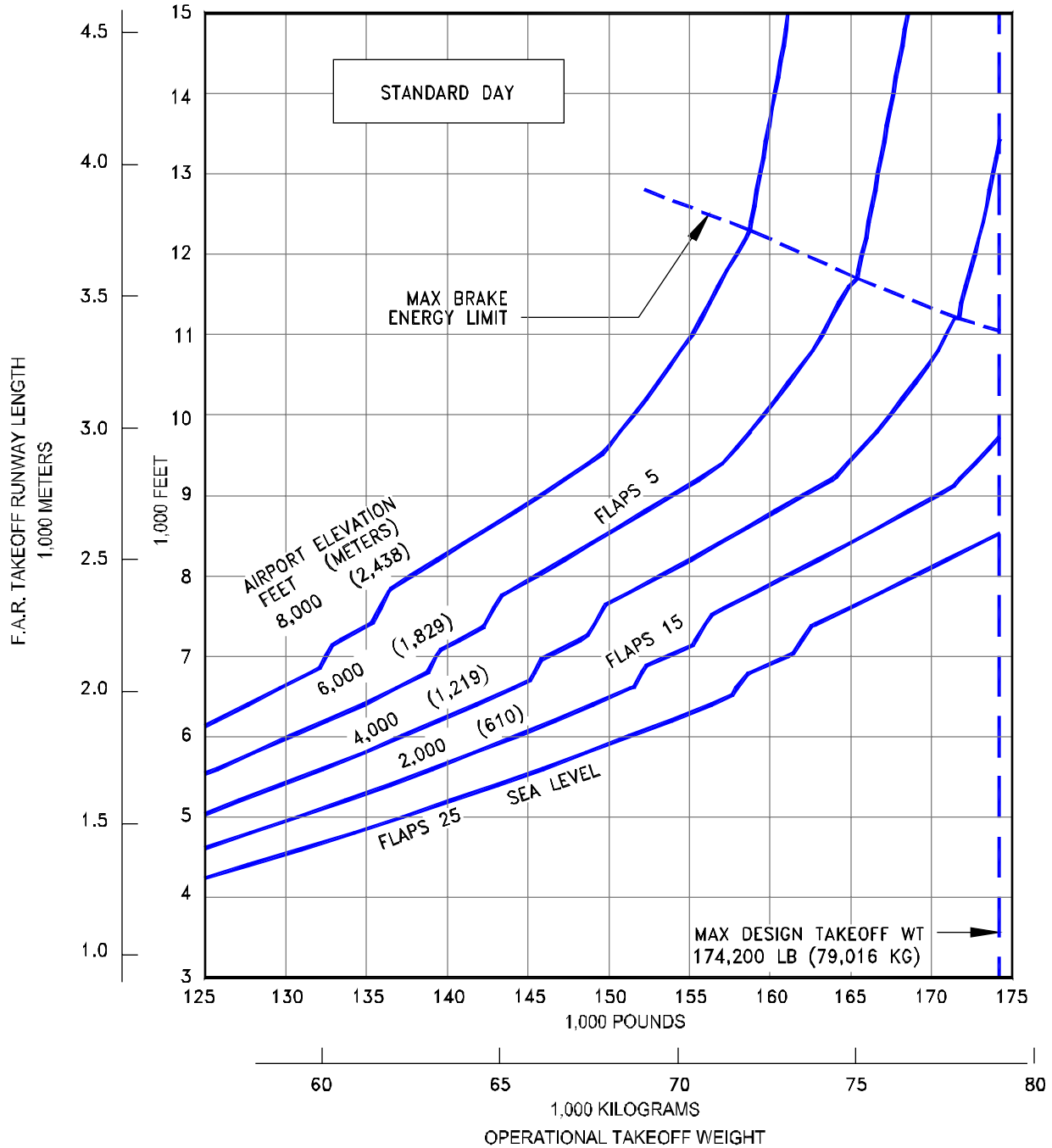

3.3.83 F.A.R. TAKEOFF RUNWAY LENGTH REQUIREMENTS

STANDARD DAY, DRY RUNWAY

MODEL 737-800 WITH WINGLETS (CFM56-7B24 ENGINES AT 24,200 LB SLST)

NOTES:

- CFM56-7B24 ENGINES RATED AT 24,200 LB SLST
- NO ENGINE AIR BLEED FOR AIR CONDITIONING
- ZERO WIND, ZERO RUNWAY GRADIENT
- DRY RUNWAY SURFACE
- CONSULT WITH USING AIRLINE FOR SPECIFIC OPERATING PROCEDURE PRIOR TO FACILITY DESIGN

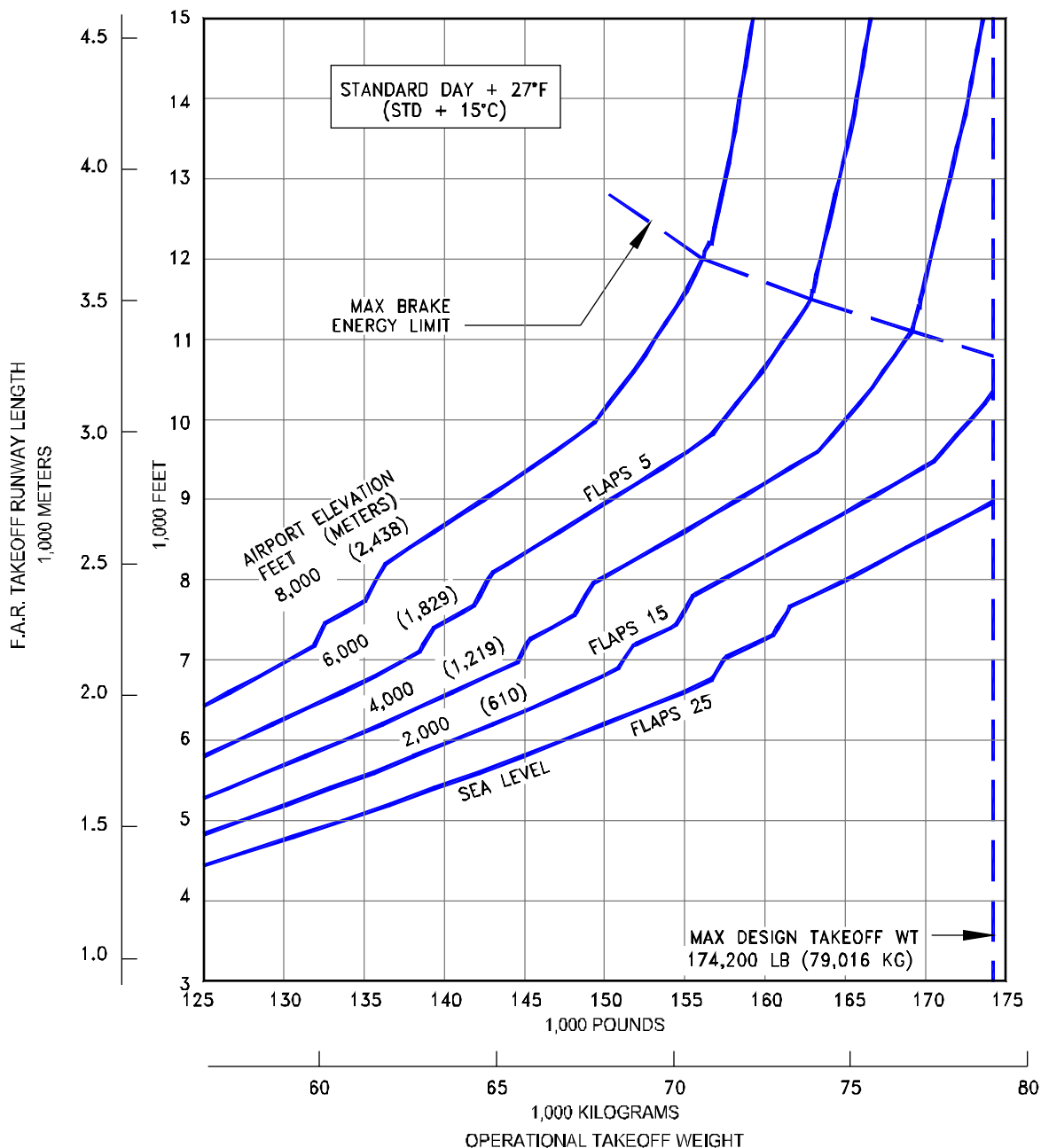

3.3.84 F.A.R. TAKEOFF RUNWAY LENGTH REQUIREMENTS

STANDARD DAY +27°F (STD + 15°C), DRY RUNWAY

MODEL 737-800 WITH WINGLETS CFM56-7B24 ENGINES AT 24,200 LB SLST)

NOTES:

- CFM56-7B24 ENGINES RATED AT 24,200 LB SLST
- NO ENGINE AIR BLEED FOR AIR CONDITIONING
- ZERO WIND, ZERO RUNWAY GRADIENT
- WET SMOOTH RUNWAY SURFACE
- CONSULT WITH USING AIRLINE FOR SPECIFIC OPERATING PROCEDURE PRIOR TO FACILITY DESIGN
- TAKEOFF PERFORMANCE IMPROVEMENTS ARE POSSIBLE USING GROOVED RUNWAY

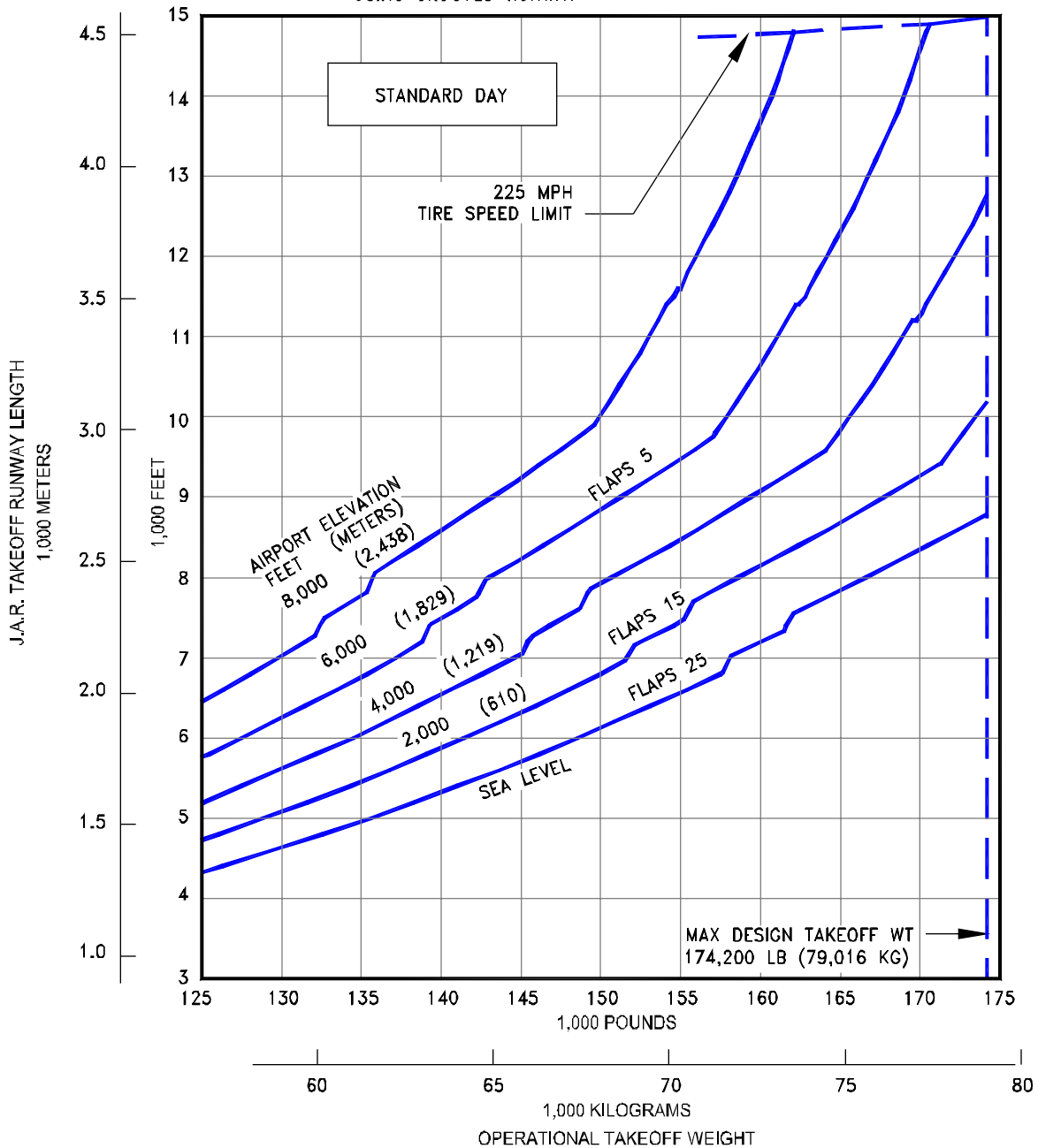

3.3.85 J.A.R. TAKEOFF RUNWAY LENGTH REQUIREMENTS

STANDARD DAY, WET RUNWAY

MODEL 737-800 WITH WINGLETS CFM56-7B24 ENGINES AT 24,200 LB SLST)

NOTES:

- CFM56-7B24 ENGINES RATED AT 24,200 LB SLST
- NO ENGINE AIR BLEED FOR AIR CONDITIONING
- ZERO WIND, ZERO RUNWAY GRADIENT
- WET SMOOTH RUNWAY SURFACE
- CONSULT WITH USING AIRLINE FOR SPECIFIC OPERATING PROCEDURE PRIOR TO FACILITY DESIGN
- TAKEOFF PERFORMANCE IMPROVEMENTS ARE POSSIBLE USING GROOVED RUNWAY

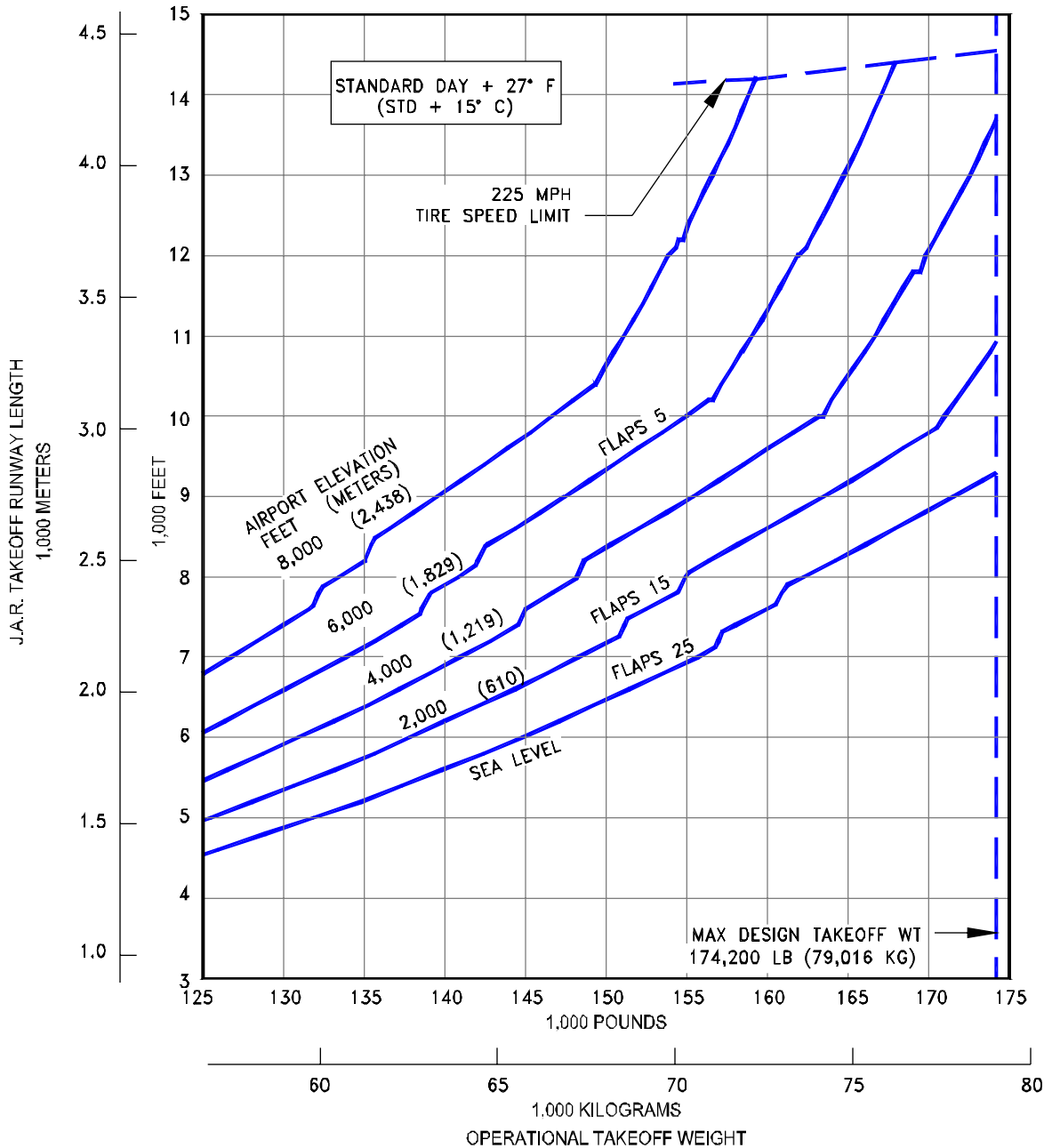

3.3.86 J.A.R. TAKEOFF RUNWAY LENGTH REQUIREMENTS

STANDARD DAY +27°F (STD + 15°C), WET RUNWAY

MODEL 737-800 WITH WINGLETS CFM56-7B24 ENGINES AT 24,200 LB SLST)

NOTES:

- CFM56-7B26 ENGINES RATED AT 26,300 LB SLST
- NO ENGINE AIR BLEED FOR AIR CONDITIONING
- ZERO WIND, ZERO RUNWAY GRADIENT
- DRY RUNWAY SURFACE
- CONSULT WITH USING AIRLINE FOR SPECIFIC OPERATING PROCEDURE PRIOR TO FACILITY DESIGN

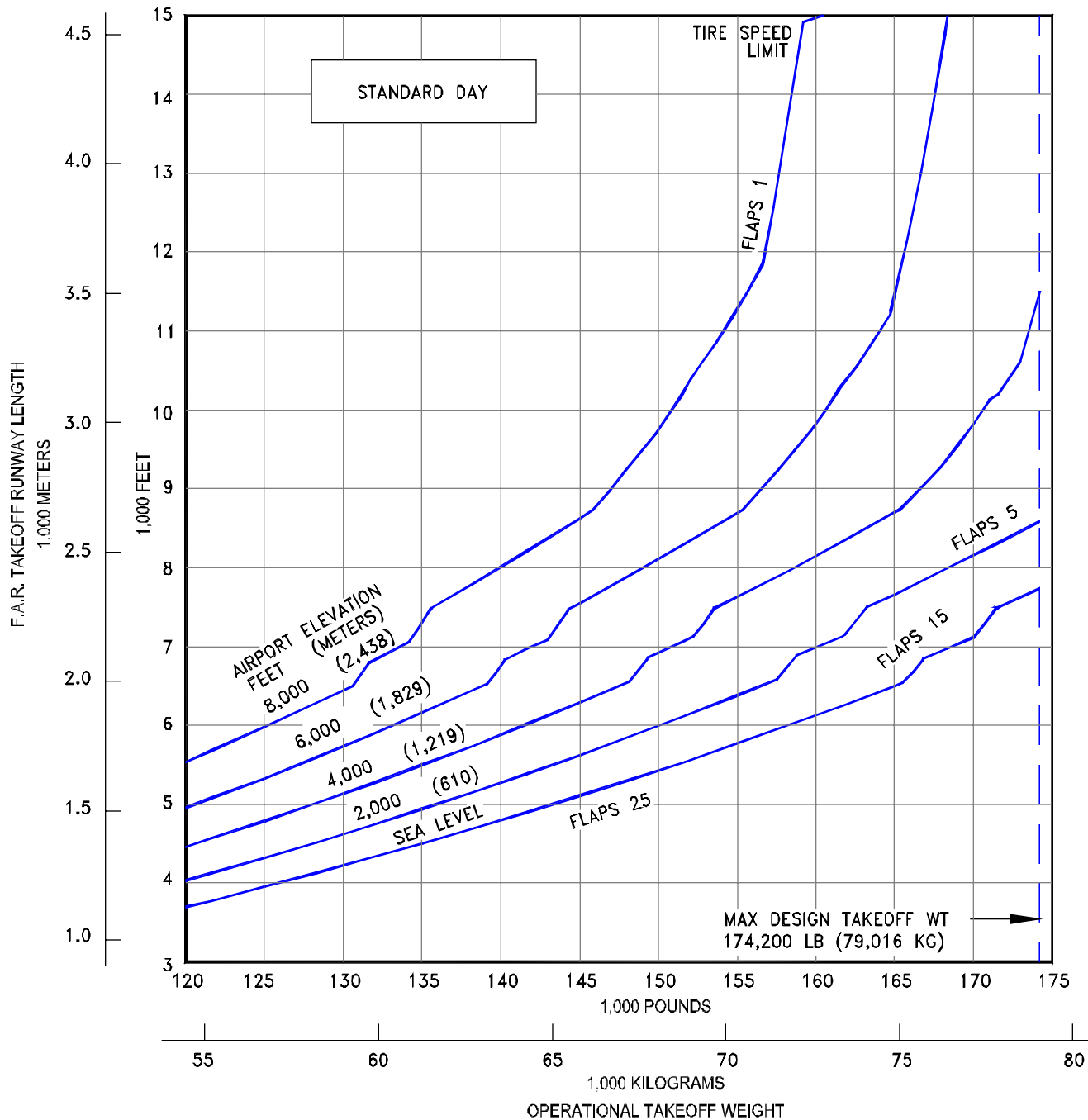

**3.3.87 F.A.R. TAKEOFF RUNWAY LENGTH REQUIREMENTS
STANDARD DAY, DRY RUNWAY**

MODEL 737-800 (CFM56-7B26 ENGINES AT 26,300 LB SLST)

NOTES:

- CFM56-7B26 ENGINES RATED AT 26,300 LB SLST
- NO ENGINE AIR BLEED FOR AIR CONDITIONING
- ZERO WIND, ZERO RUNWAY GRADIENT
- DRY RUNWAY SURFACE
- CONSULT WITH USING AIRLINE FOR SPECIFIC OPERATING PROCEDURE PRIOR TO FACILITY DESIGN

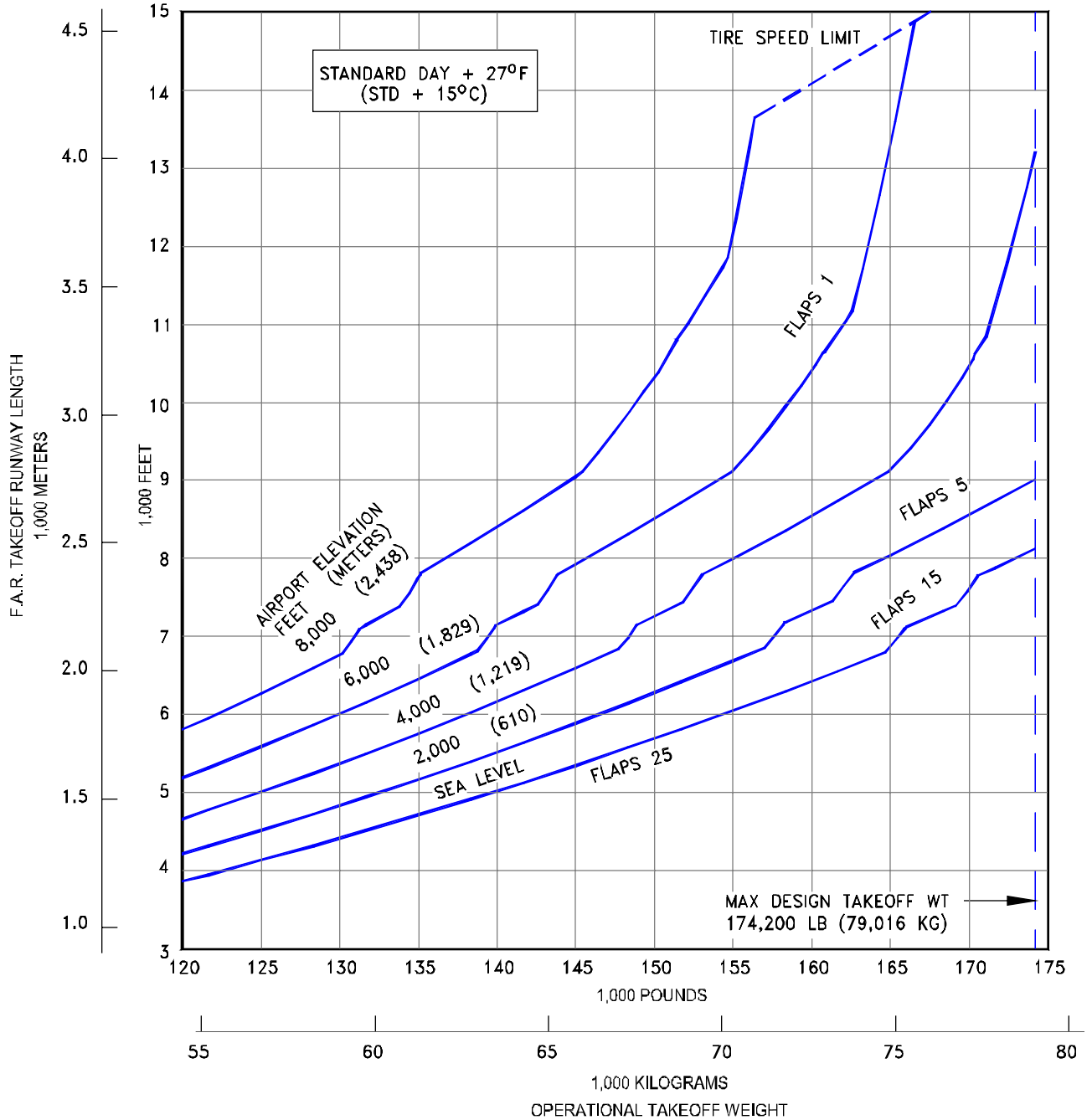

3.3.88 F.A.R. TAKEOFF RUNWAY LENGTH REQUIREMENTS
STANDARD DAY +27°F (STD + 15°C), DRY RUNWAY
MODEL 737-800 (CFM56-7B26 ENGINES AT 26,300 LB SLST)

NOTES:

- CFM56-7B26 ENGINES RATED AT 26,300 LB SLST
- NO ENGINE AIR BLEED FOR AIR CONDITIONING
- ZERO WIND, ZERO RUNWAY GRADIENT
- WET SMOOTH RUNWAY SURFACE
- CONSULT WITH USING AIRLINE FOR SPECIFIC OPERATING PROCEDURE PRIOR TO FACILITY DESIGN
- TAKEOFF PERFORMANCE IMPROVEMENTS ARE POSSIBLE USING GROOVED RUNWAY

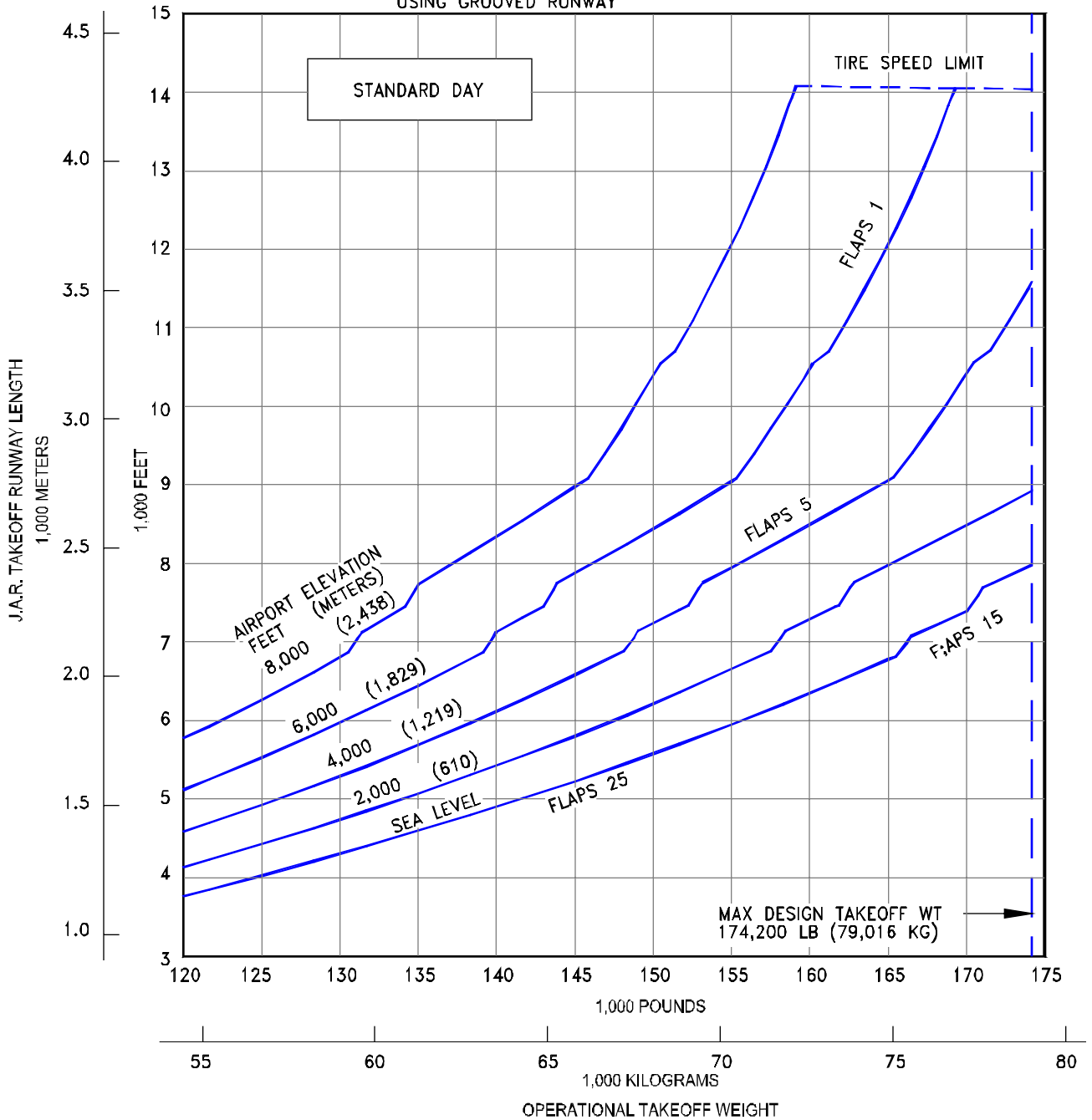

3.3.89 J.A.R. TAKEOFF RUNWAY LENGTH REQUIREMENTS
STANDARD DAY, WET RUNWAY
 MODEL 737-800 (CFM56-7B26 ENGINES AT 26,300 LB SLST)

D6-58325-6

NOTES:

- CFM56-7B26 ENGINES RATED AT 26,300 LB SLST
- NO ENGINE AIR BLEED FOR AIR CONDITIONING
- ZERO WIND, ZERO RUNWAY GRADIENT
- WET SMOOTH RUNWAY SURFACE
- CONSULT WITH USING AIRLINE FOR SPECIFIC OPERATING PROCEDURE PRIOR TO FACILITY DESIGN
- TAKEOFF PERFORMANCE IMPROVEMENTS ARE POSSIBLE USING GROOVED RUNWAY

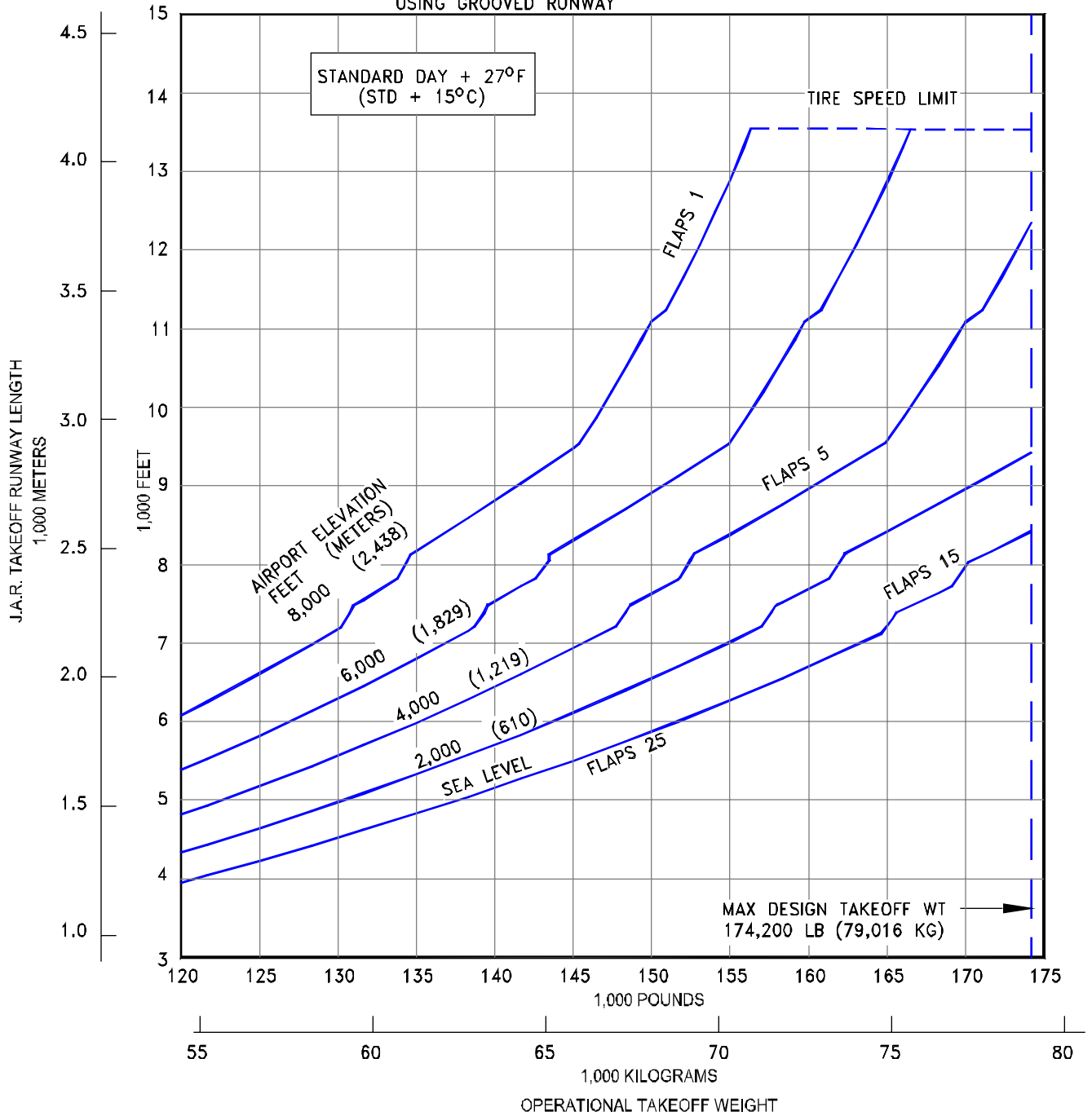

3.3.90 J.A.R. TAKEOFF RUNWAY LENGTH REQUIREMENTS
STANDARD DAY +27°F (STD + 15°C), WET RUNWAY
MODEL 737-800 (CFM56-7B26 ENGINES AT 26,300 LB SLST)

NOTES:

- CFM56-7B26 ENGINES RATED AT 26,300 LB SLST
- NO ENGINE AIR BLEED FOR AIR CONDITIONING
- ZERO WIND, ZERO RUNWAY GRADIENT
- DRY RUNWAY SURFACE
- CONSULT WITH USING AIRLINE FOR SPECIFIC OPERATING PROCEDURE PRIOR TO FACILITY DESIGN

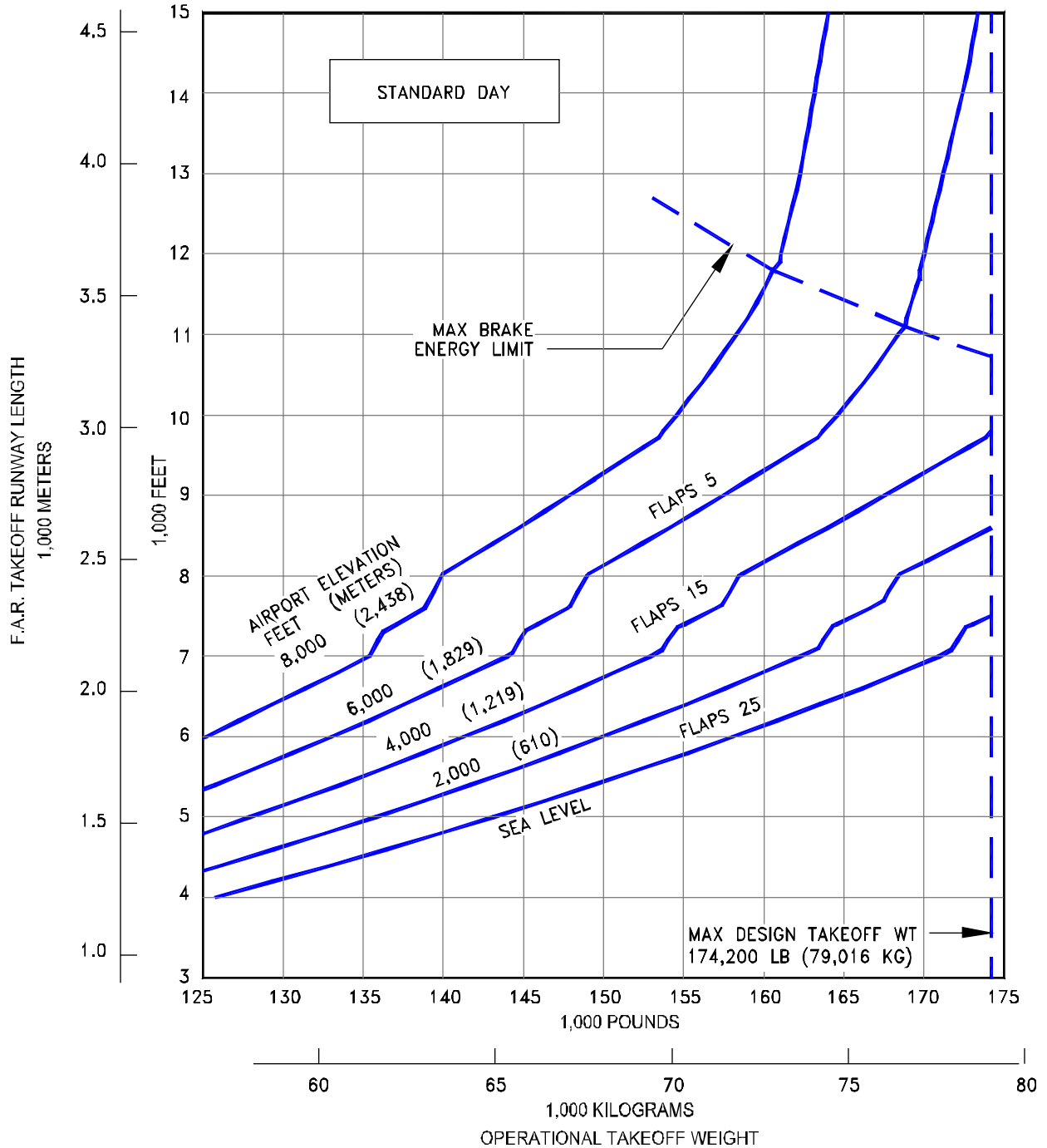

3.3.91 F.A.R. TAKEOFF RUNWAY LENGTH REQUIREMENTS

STANDARD DAY, DRY RUNWAY

MODEL 737-800 WITH WINGLETS (CFM56-7B26 ENGINES AT 26,300 LB SLST)

D6-58325-6

NOTES:

- CFM56-7B26 ENGINES RATED AT 26,300 LB SLST
- NO ENGINE AIR BLEED FOR AIR CONDITIONING
- ZERO WIND, ZERO RUNWAY GRADIENT
- DRY RUNWAY SURFACE
- CONSULT WITH USING AIRLINE FOR SPECIFIC OPERATING PROCEDURE PRIOR TO FACILITY DESIGN

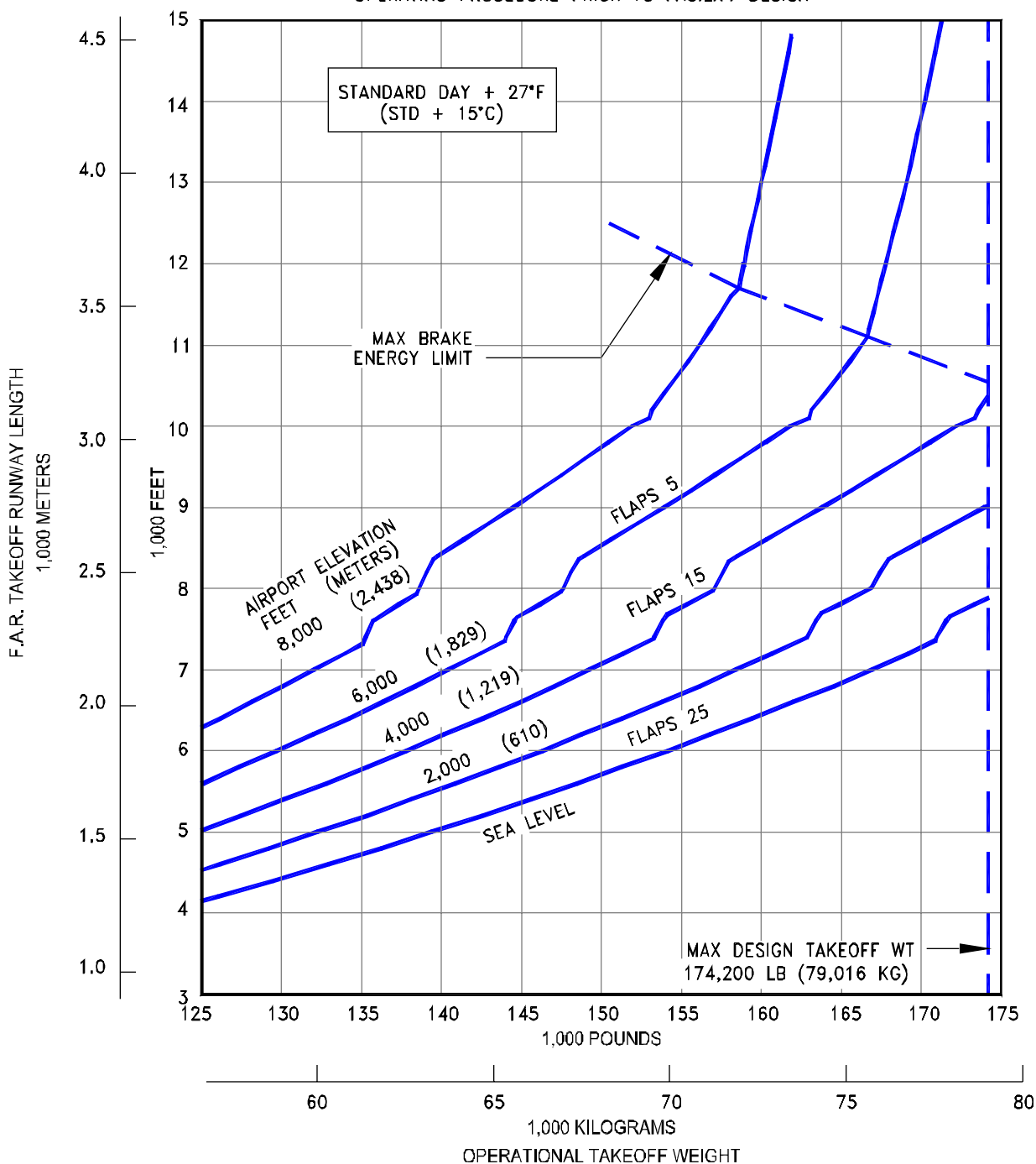

3.3.92 F.A.R. TAKEOFF RUNWAY LENGTH REQUIREMENTS

STANDARD DAY +27°F (STD + 15°C), DRY RUNWAY

MODEL 737-800 WITH WINGLETS (CFM56-7B26 ENGINES AT 26,300 LB SLST)

NOTES:

- ◆ CFM56-7B26 ENGINES RATED AT 26,300 LB SLST
- ◆ NO ENGINE AIR BLEED FOR AIR CONDITIONING
- ◆ ZERO WIND, ZERO RUNWAY GRADIENT
- ◆ WET SMOOTH RUNWAY SURFACE
- ◆ CONSULT WITH USING AIRLINE FOR SPECIFIC OPERATING PROCEDURE PRIOR TO FACILITY DESIGN
- ◆ TAKEOFF PERFORMANCE IMPROVEMENTS ARE POSSIBLE USING GROOVED RUNWAY

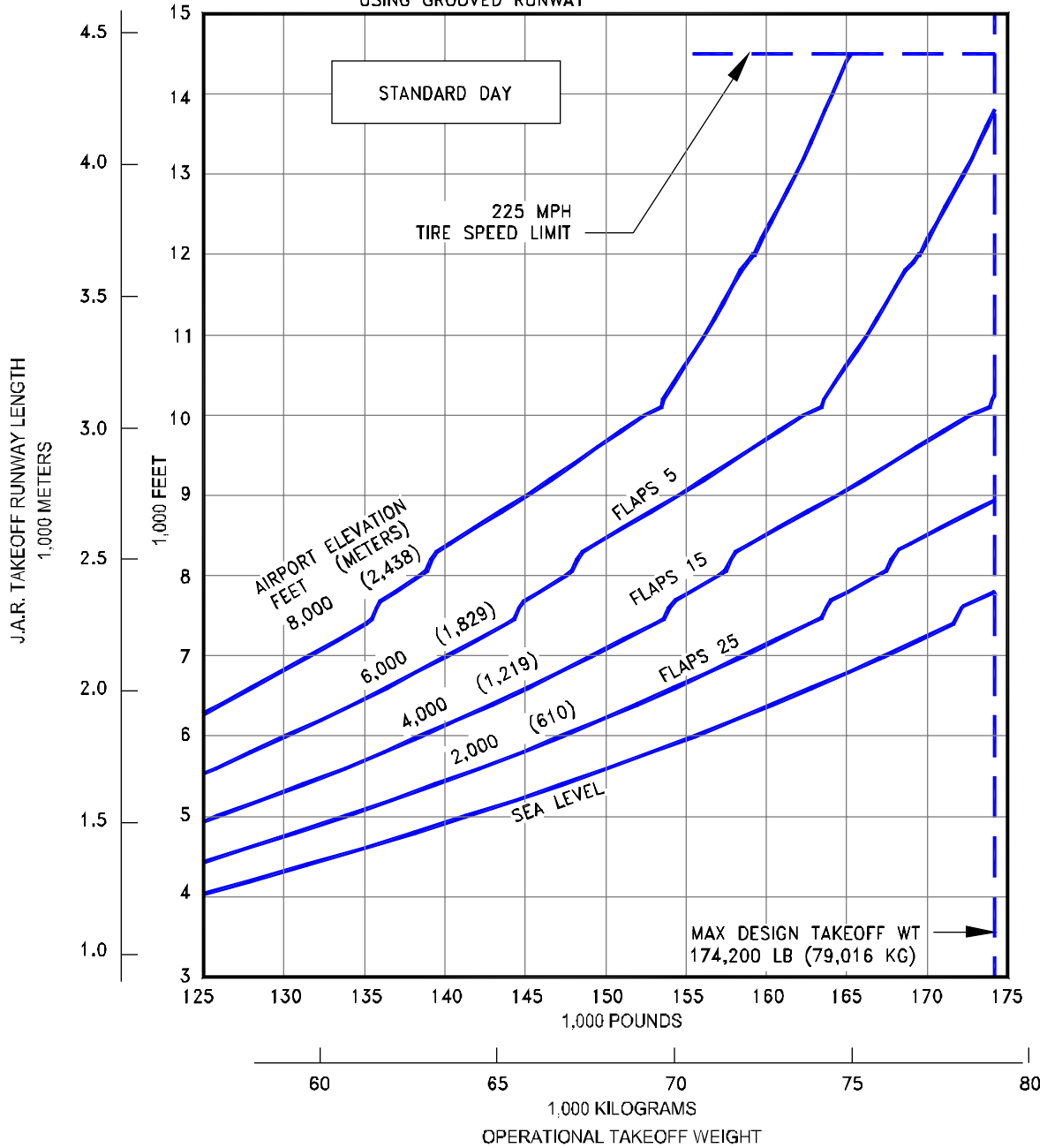

**3.3.93 J.A.R. TAKEOFF RUNWAY LENGTH REQUIREMENTS
STANDARD DAY, WET RUNWAY**

MODEL 737-800 WITH WINGLETS (CFM56-7B26 ENGINES AT 26,300 LB SLST)

NOTES:

- CFM56-7B26 ENGINES RATED AT 26,300 LB SLST
- NO ENGINE AIR BLEED FOR AIR CONDITIONING
- ZERO WIND, ZERO RUNWAY GRADIENT
- WET SMOOTH RUNWAY SURFACE
- CONSULT WITH USING AIRLINE FOR SPECIFIC OPERATING PROCEDURE PRIOR TO FACILITY DESIGN
- TAKEOFF PERFORMANCE IMPROVEMENTS ARE POSSIBLE USING GROOVED RUNWAY

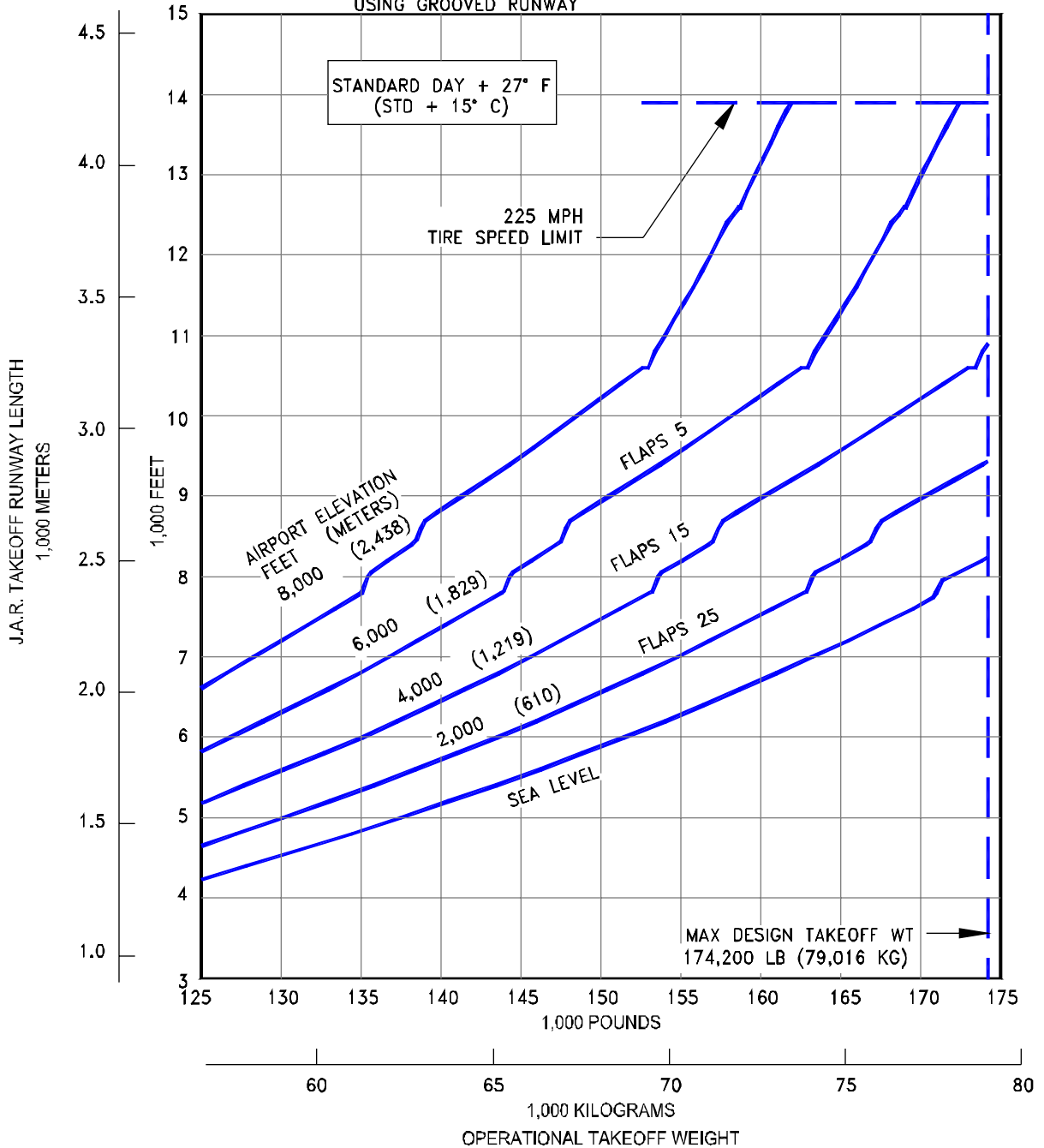

3.3.94 J.A.R. TAKEOFF RUNWAY LENGTH REQUIREMENTS

STANDARD DAY +27°F (STD + 15°C), WET RUNWAY

MODEL 737-800 WITH WINGLETS (CFM56-7B26 ENGINES AT 26,300 LB SLST)

NOTES:

- CFM56-7B27 ENGINES RATED AT 27,300 LB SLST
- NO ENGINE AIR BLEED FOR AIR CONDITIONING
- ZERO WIND, ZERO RUNWAY GRADIENT
- DRY RUNWAY SURFACE
- CONSULT WITH USING AIRLINE FOR SPECIFIC OPERATING PROCEDURE PRIOR TO FACILITY DESIGN

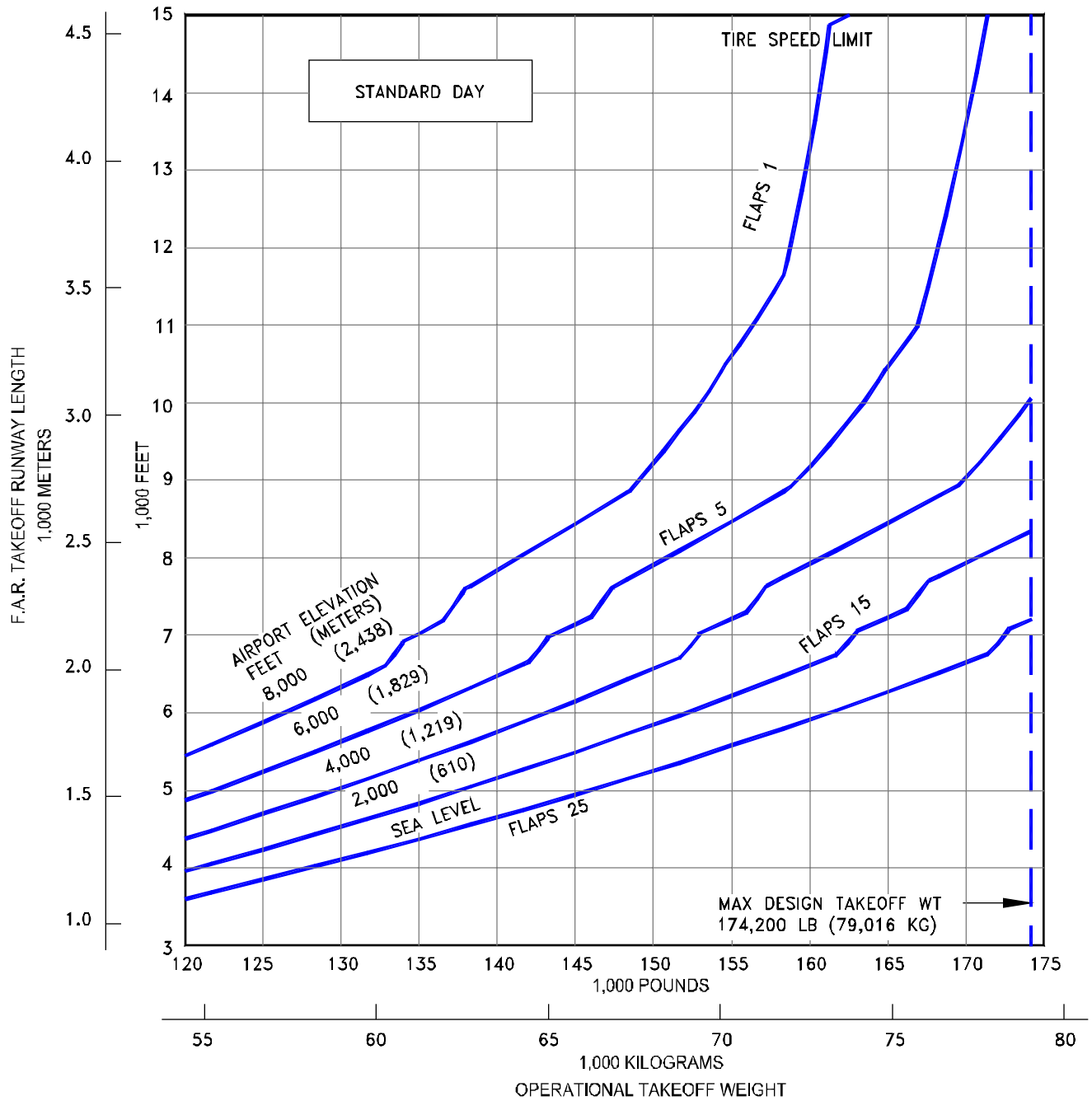

3.3.95 F.A.R. TAKEOFF RUNWAY LENGTH REQUIREMENTS
STANDARD DAY, DRY RUNWAY
MODEL 737-800 (CFM56-7B27 ENGINES AT 27,300 LB SLST)

D6-58325-6

NOTES:

- CFM56-7B27 ENGINES RATED AT 27,300 LB SLST
- NO ENGINE AIR BLEED FOR AIR CONDITIONING
- ZERO WIND, ZERO RUNWAY GRADIENT
- DRY RUNWAY SURFACE
- CONSULT WITH USING AIRLINE FOR SPECIFIC OPERATING PROCEDURE PRIOR TO FACILITY DESIGN

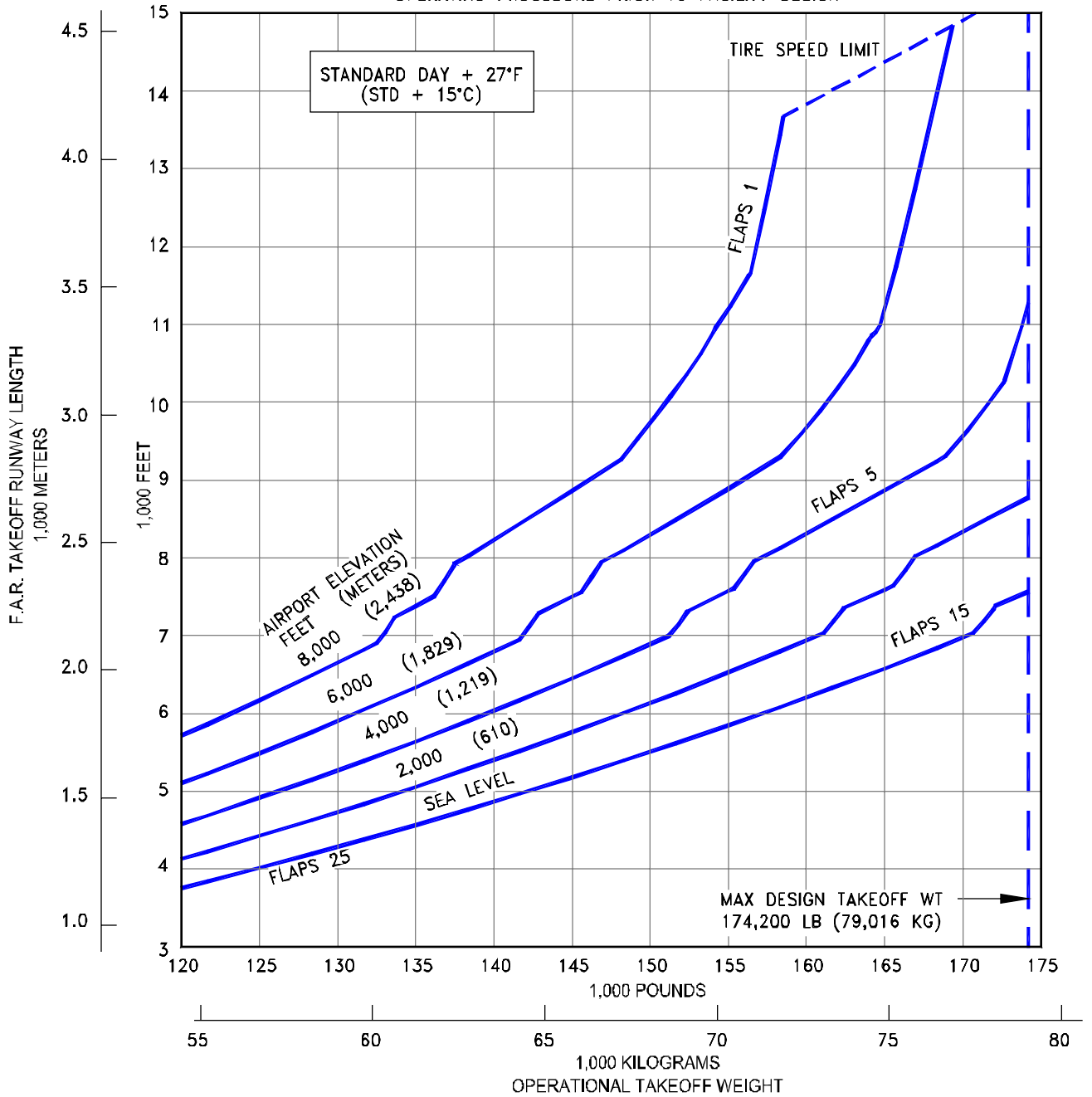

3.3.96 F.A.R. TAKEOFF RUNWAY LENGTH REQUIREMENTS
STANDARD DAY +27°F (STD + 15°C), DRY RUNWAY
MODEL 737-800 (CFM56-7B27 ENGINES AT 27,300 LB SLST)

NOTES:

- CFM56-7B27 ENGINES RATED AT 27,300 LB SLST
- NO ENGINE AIR BLEED FOR AIR CONDITIONING
- ZERO WIND, ZERO RUNWAY GRADIENT
- WET SMOOTH RUNWAY SURFACE
- CONSULT WITH USING AIRLINE FOR SPECIFIC OPERATING PROCEDURE PRIOR TO FACILITY DESIGN
- ◆ TAKEOFF PERFORMANCE IMPROVEMENTS ARE POSSIBLE USING GROOVED RUNWAY

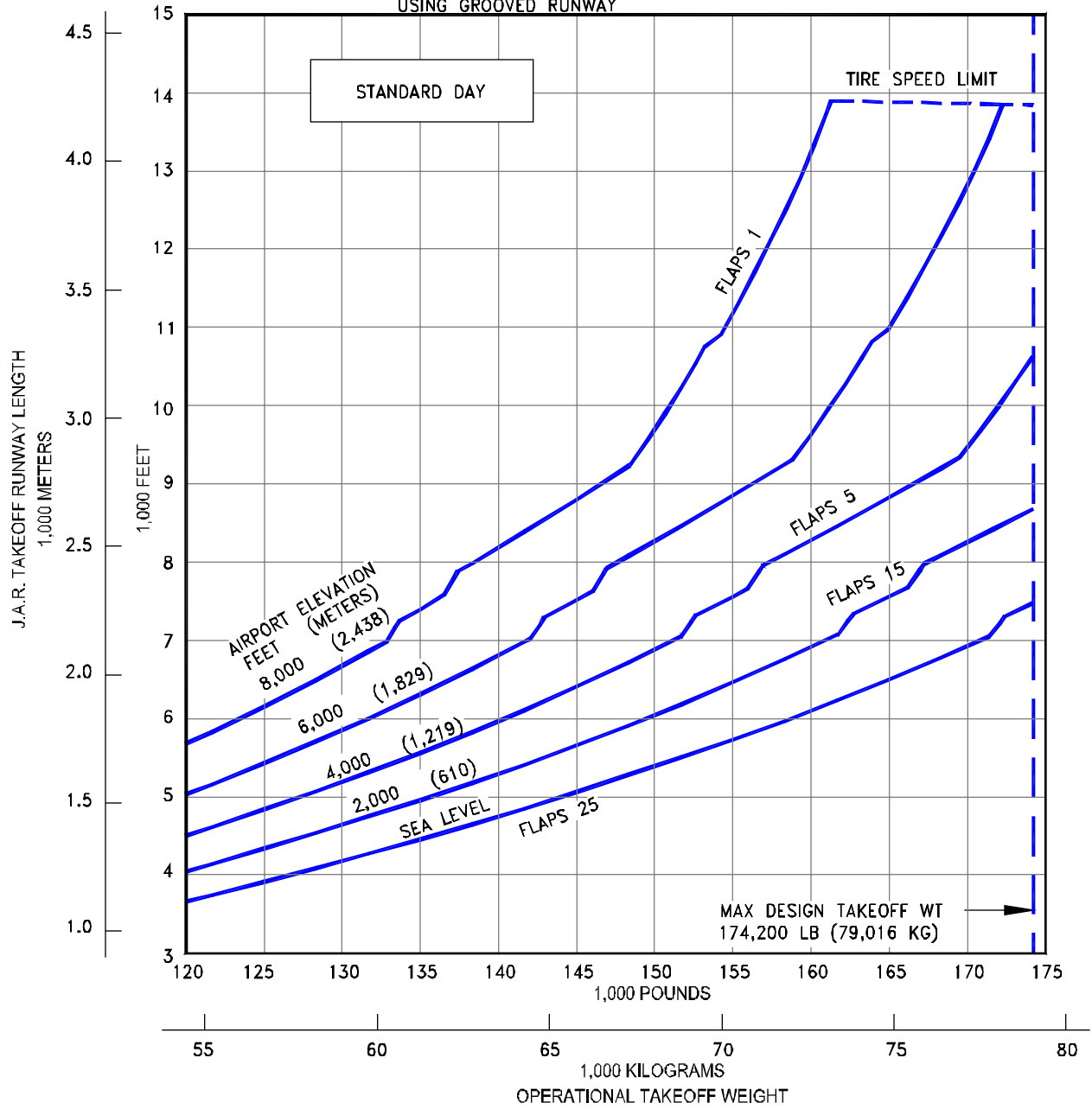

3.3.97 J.A.R. TAKEOFF RUNWAY LENGTH REQUIREMENTS
STANDARD DAY, WET RUNWAY
 MODEL 737-800 (CFM56-7B27 ENGINES AT 27,300 LB SLST)

NOTES:

- CFM56-7B27 ENGINES RATED AT 27,300 LB SLST
- NO ENGINE AIR BLEED FOR AIR CONDITIONING
- ZERO WIND, ZERO RUNWAY GRADIENT
- WET SMOOTH RUNWAY SURFACE
- CONSULT WITH USING AIRLINE FOR SPECIFIC OPERATING PROCEDURE PRIOR TO FACILITY DESIGN
- TAKEOFF PERFORMANCE IMPROVEMENTS ARE POSSIBLE USING GROOVED RUNWAY

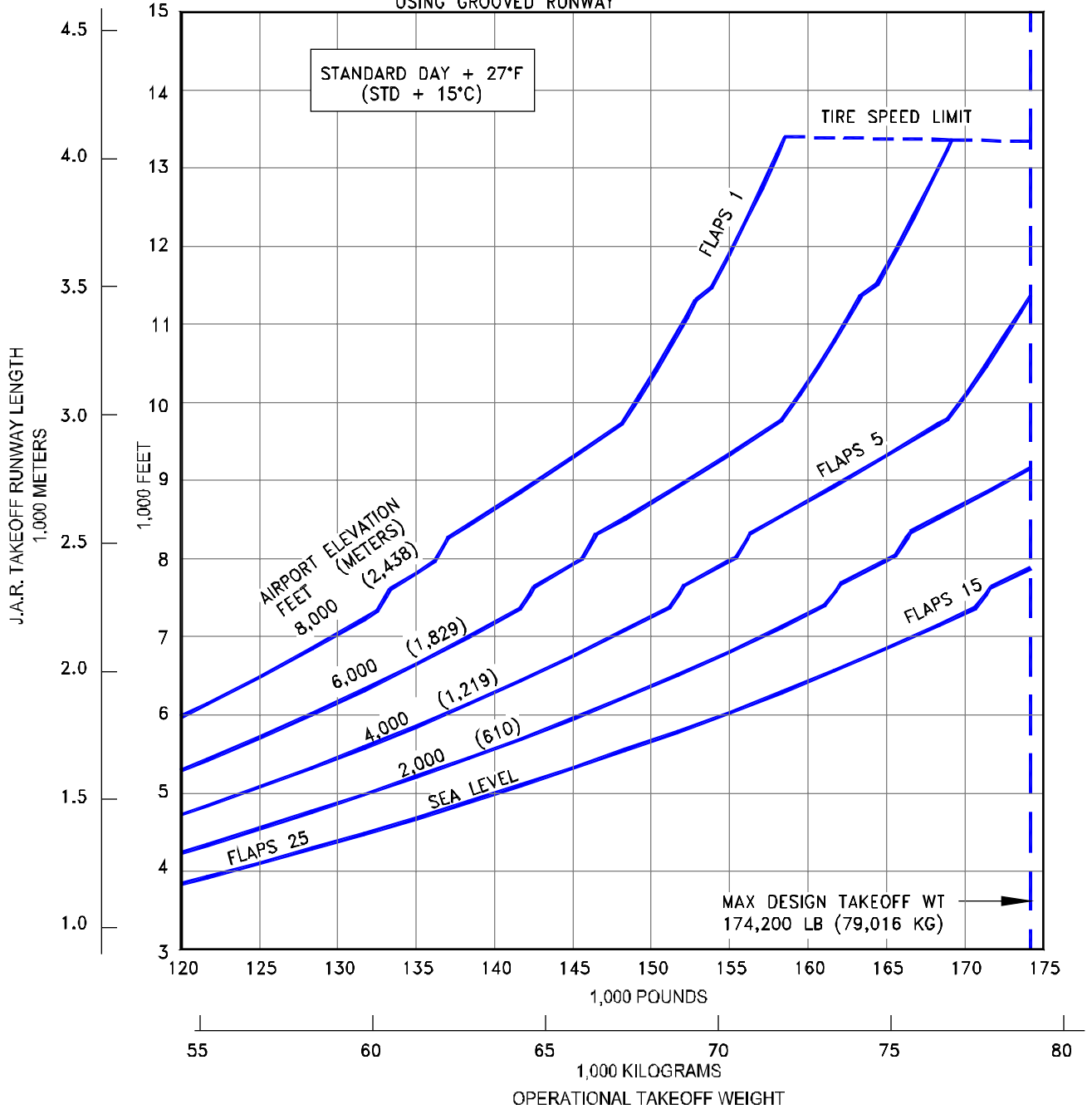

3.3.98 J.A.R. TAKEOFF RUNWAY LENGTH REQUIREMENTS
STANDARD DAY +27°F (STD + 15°C), WET RUNWAY
MODEL 737-800 (CFM56-7B27 ENGINES AT 27,300 LB SLST)

NOTES:

- CFM56-7B27 ENGINES RATED AT 27,300 LB SLST
- NO ENGINE AIR BLEED FOR AIR CONDITIONING
- ZERO WIND, ZERO RUNWAY GRADIENT
- DRY RUNWAY SURFACE
- CONSULT WITH USING AIRLINE FOR SPECIFIC OPERATING PROCEDURE PRIOR TO FACILITY DESIGN

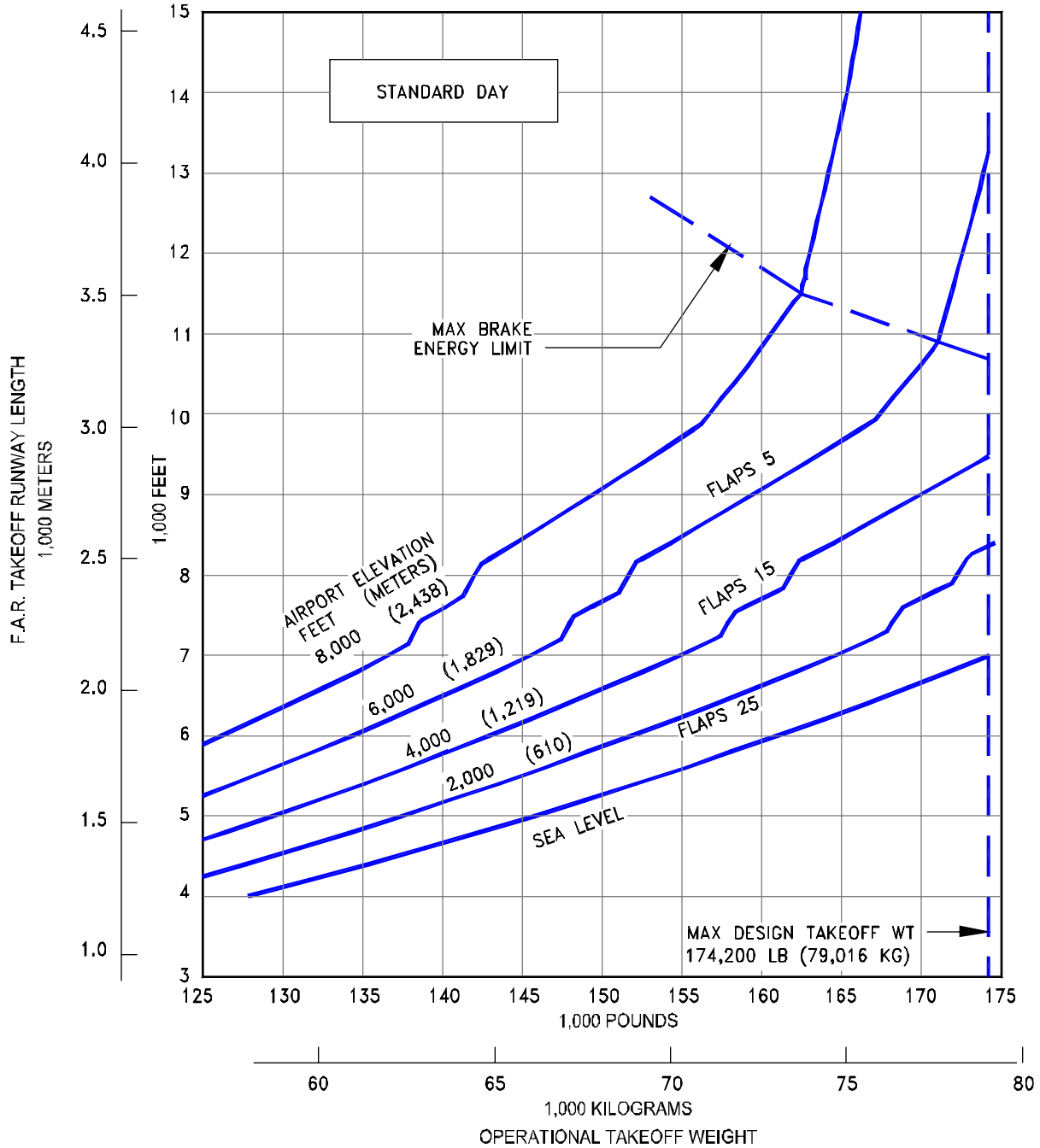

**3.3.99 F.A.R. TAKEOFF RUNWAY LENGTH REQUIREMENTS
STANDARD DAY, DRY RUNWAY**

MODEL 737-800 WITH WINGLETS (CFM56-7B27 ENGINES AT 27,300 LB SLST)

NOTES:

- CFM56-7B27 ENGINES RATED AT 27,300 LB SLST
- NO ENGINE AIR BLEED FOR AIR CONDITIONING
- ZERO WIND, ZERO RUNWAY GRADIENT
- DRY RUNWAY SURFACE
- CONSULT WITH USING AIRLINE FOR SPECIFIC OPERATING PROCEDURE PRIOR TO FACILITY DESIGN

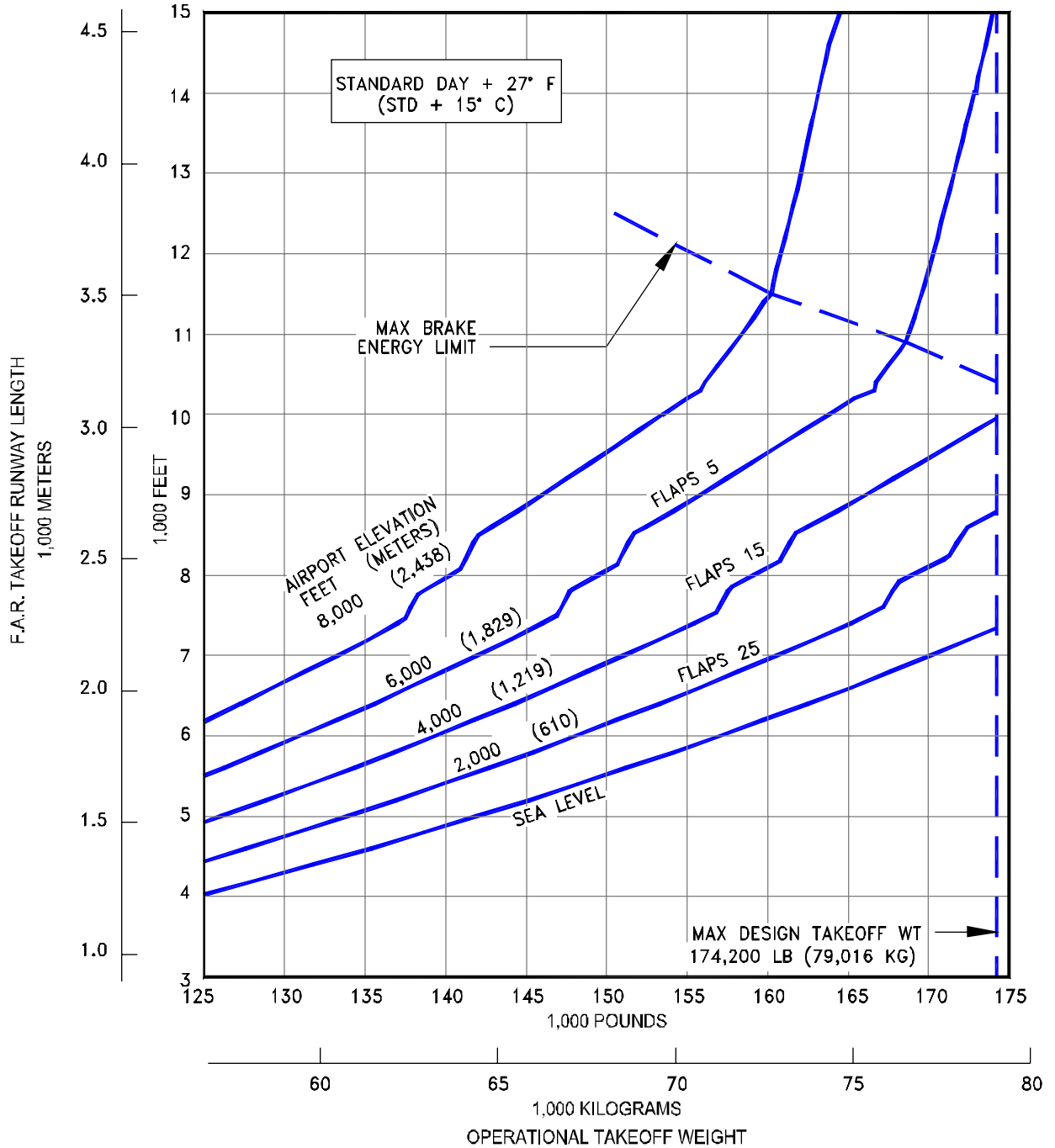

3.3.100 F.A.R. TAKEOFF RUNWAY LENGTH REQUIREMENTS

STANDARD DAY +27°F (STD + 15°C), DRY RUNWAY

MODEL 737-800 WITH WINGLETS (CFM56-7B27 ENGINES AT 27,300 LB SLST)

NOTES:

- CFM56-7B27 ENGINES RATED AT 27,300 LB SLST
- NO ENGINE AIR BLEED FOR AIR CONDITIONING
- ZERO WIND, ZERO RUNWAY GRADIENT
- WET SMOOTH RUNWAY SURFACE
- CONSULT WITH USING AIRLINE FOR SPECIFIC OPERATING PROCEDURE PRIOR TO FACILITY DESIGN
- TAKEOFF PERFORMANCE IMPROVEMENTS ARE POSSIBLE USING GROOVED RUNWAY

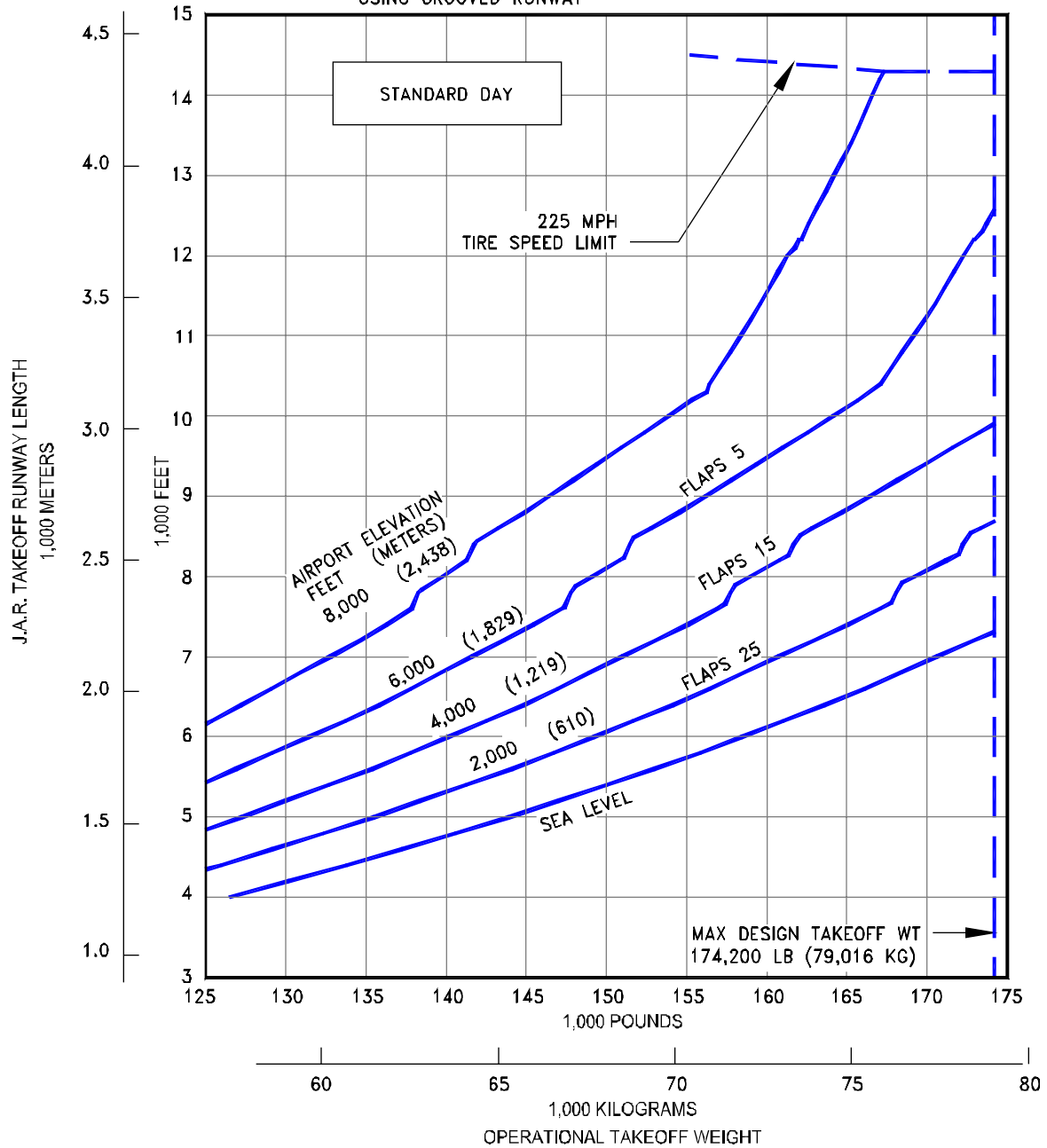

**3.3.101 J.A.R. TAKEOFF RUNWAY LENGTH REQUIREMENTS
STANDARD DAY, WET RUNWAY**

MODEL 737-800 WITH WINGLETS (CFM56-7B27 ENGINES AT 27,300 LB SLST)

D6-58325-6

NOTES:

- CFM56-7B27 ENGINES RATED AT 27,300 LB SLST
- NO ENGINE AIR BLEED FOR AIR CONDITIONING
- ZERO WIND, ZERO RUNWAY GRADIENT
- WET SMOOTH RUNWAY SURFACE
- CONSULT WITH USING AIRLINE FOR SPECIFIC OPERATING PROCEDURE PRIOR TO FACILITY DESIGN
- TAKEOFF PERFORMANCE IMPROVEMENTS ARE POSSIBLE USING GROOVED RUNWAY

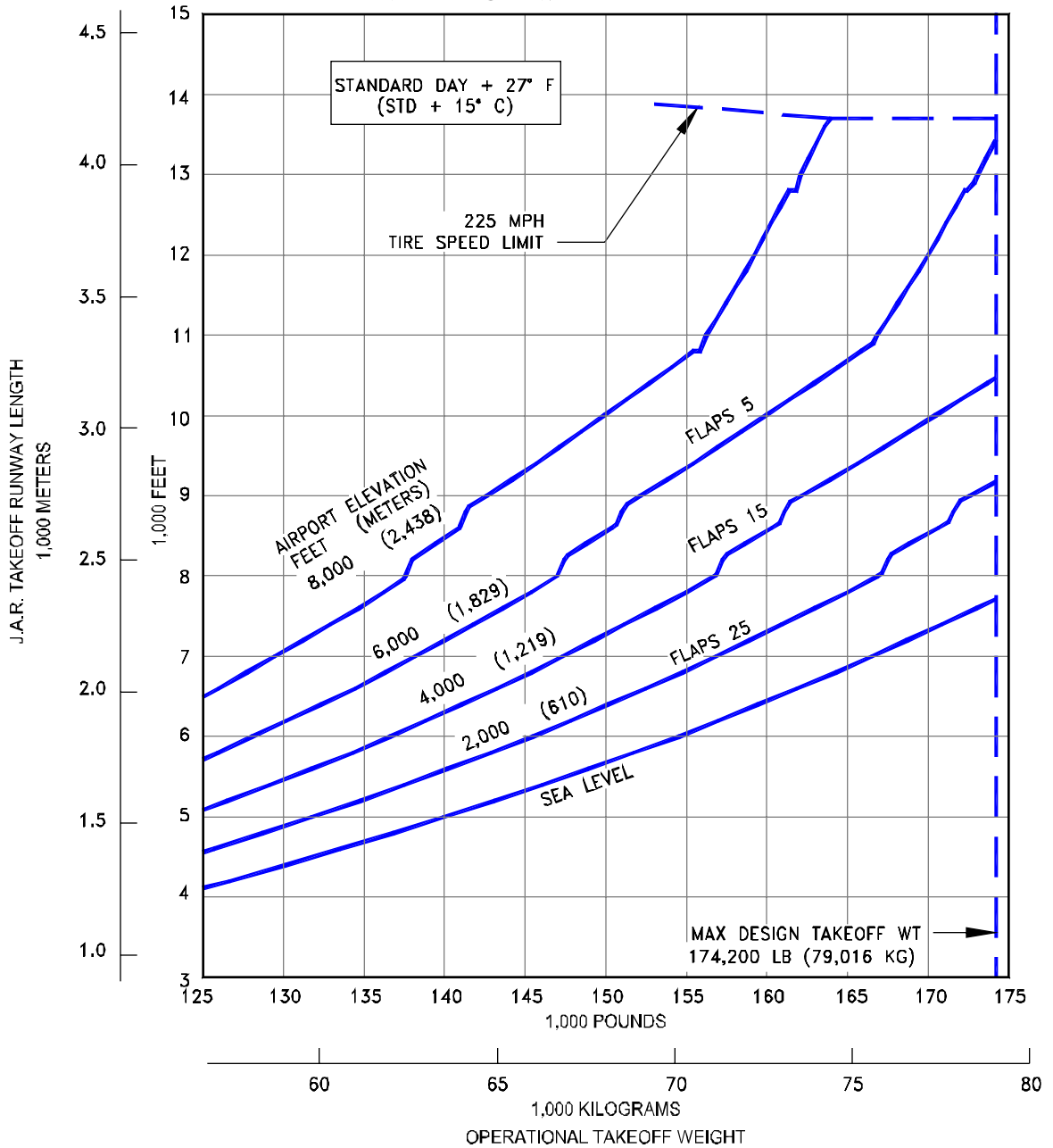

3.3.102 J.A.R. TAKEOFF RUNWAY LENGTH REQUIREMENTS

STANDARD DAY +27°F (STD + 15°C), WET RUNWAY

MODEL 737-800 WITH WINGLETS (CFM56-7B27 ENGINES AT 27,300 LB SLST)

NOTES:

- CFM56-7B27B1 ENGINES RATED AT 27,300 LB SLST
- NO ENGINE AIR BLEED FOR AIR CONDITIONING
- ZERO WIND, ZERO RUNWAY GRADIENT
- DRY RUNWAY SURFACE
- CONSULT WITH USING AIRLINE FOR SPECIFIC OPERATING PROCEDURE PRIOR TO FACILITY DESIGN

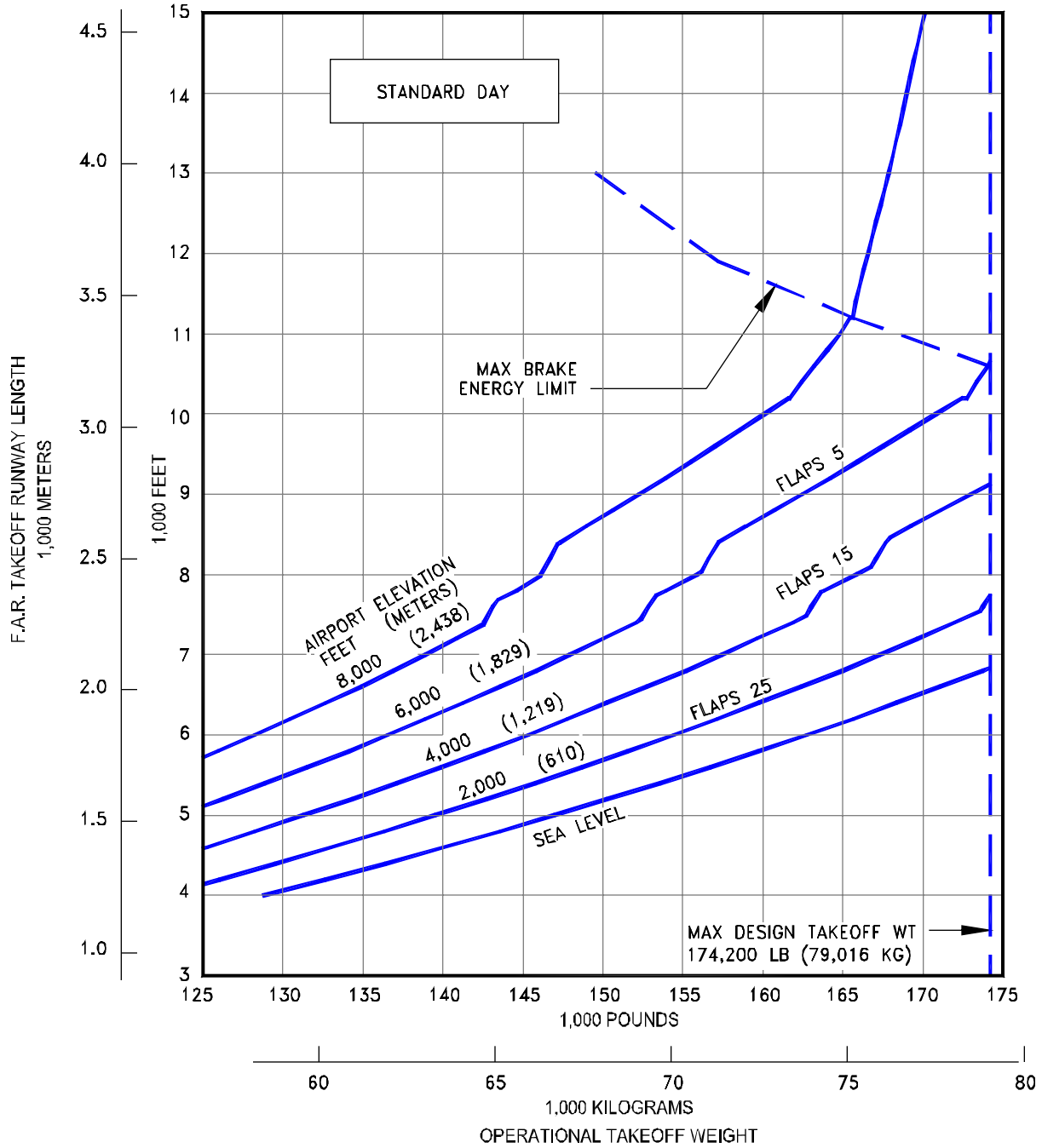

**3.3.103 F.A.R. TAKEOFF RUNWAY LENGTH REQUIREMENTS
STANDARD DAY, DRY RUNWAY**

MODEL 737-800 WITH WINGLETS, (CFM56-7B27 ENGINES AT 27,300 LB SLST)

NOTES:

- CFM56-7B27B1 ENGINES RATED AT 27,300 LB SLST
- NO ENGINE AIR BLEED FOR AIR CONDITIONING
- ZERO WIND, ZERO RUNWAY GRADIENT
- DRY RUNWAY SURFACE
- CONSULT WITH USING AIRLINE FOR SPECIFIC OPERATING PROCEDURE PRIOR TO FACILITY DESIGN

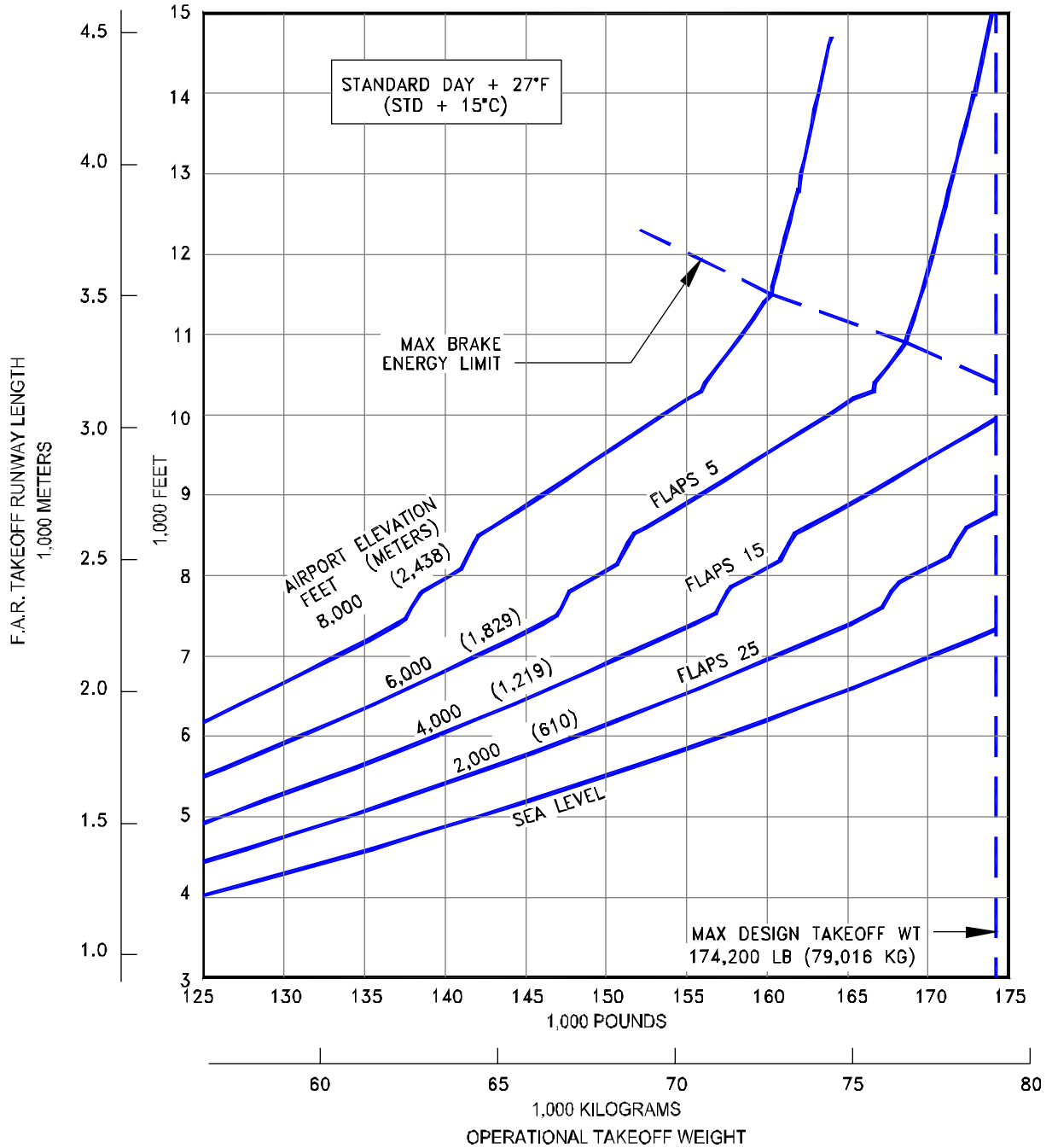

3.3.104 F.A.R. TAKEOFF RUNWAY LENGTH REQUIREMENTS

STANDARD DAY +27°F (STD + 15°C), DRY RUNWAY

MODEL 737-800 WITH WINGLETS, (CFM56-7B27 ENGINES AT 27,300 LB SLST)

NOTES:

- CFM56-7B27B1 ENGINES RATED AT 27,300 LB SLST
- NO ENGINE AIR BLEED FOR AIR CONDITIONING
- ZERO WIND, ZERO RUNWAY GRADIENT
- WET SMOOTH RUNWAY SURFACE
- CONSULT WITH USING AIRLINE FOR SPECIFIC OPERATING PROCEDURE PRIOR TO FACILITY DESIGN
- ◆ TAKEOFF PERFORMANCE IMPROVEMENTS ARE POSSIBLE USING GROOVED RUNWAY

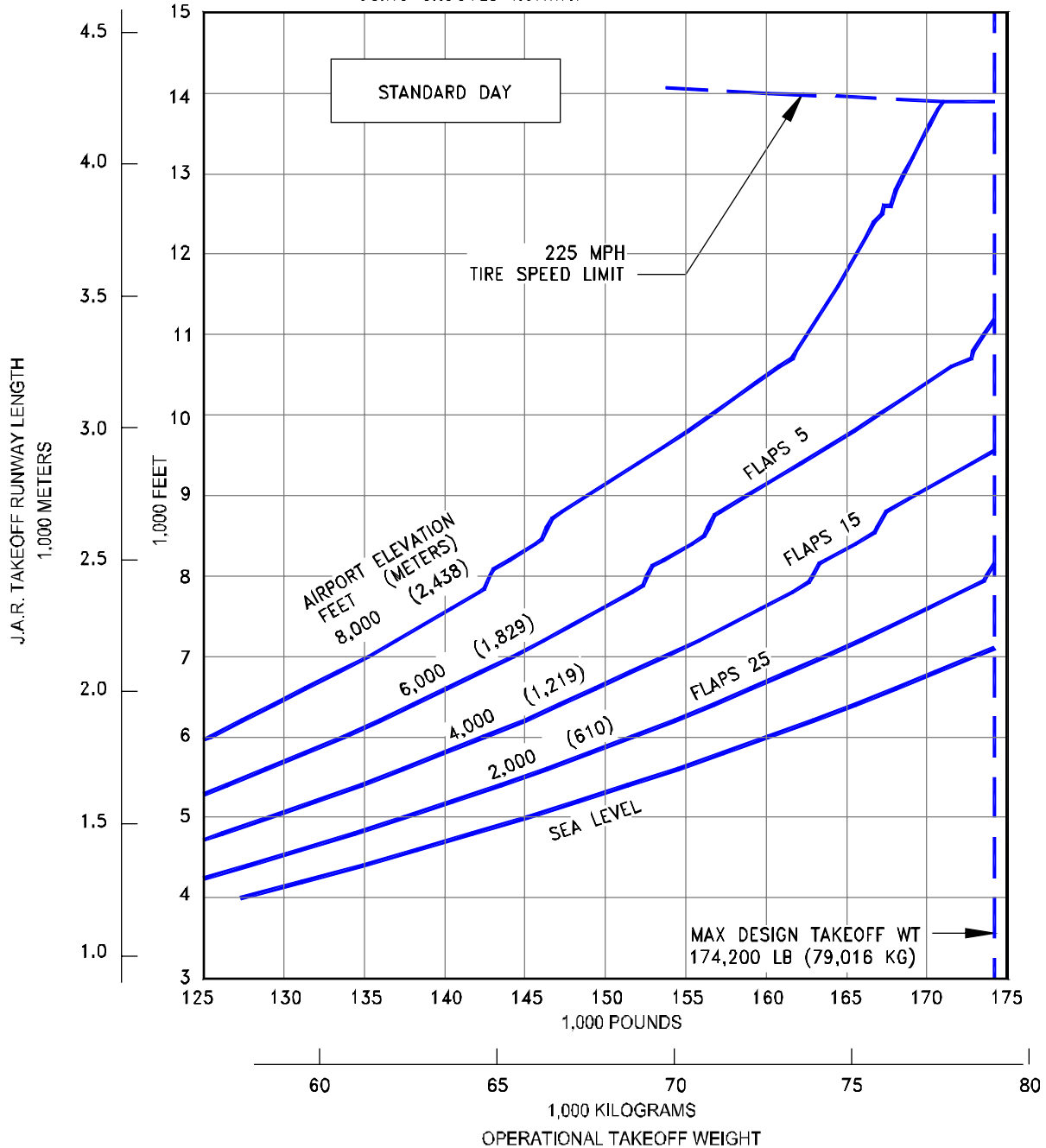

3.3.105 J.A.R. TAKEOFF RUNWAY LENGTH REQUIREMENTS

STANDARD DAY, WET RUNWAY

MODEL 737-800 WITH WINGLETS, (CFM56-7B27 ENGINES AT 27,300 LB SLST)

D6-58325-6

NOTES:

- CFM56-7B27B1 ENGINES RATED AT 27,300 LB SLST
- NO ENGINE AIR BLEED FOR AIR CONDITIONING
- ZERO WIND, ZERO RUNWAY GRADIENT
- WET SMOOTH RUNWAY SURFACE
- CONSULT WITH USING AIRLINE FOR SPECIFIC OPERATING PROCEDURE PRIOR TO FACILITY DESIGN
- TAKEOFF PERFORMANCE IMPROVEMENTS ARE POSSIBLE USING GROOVED RUNWAY

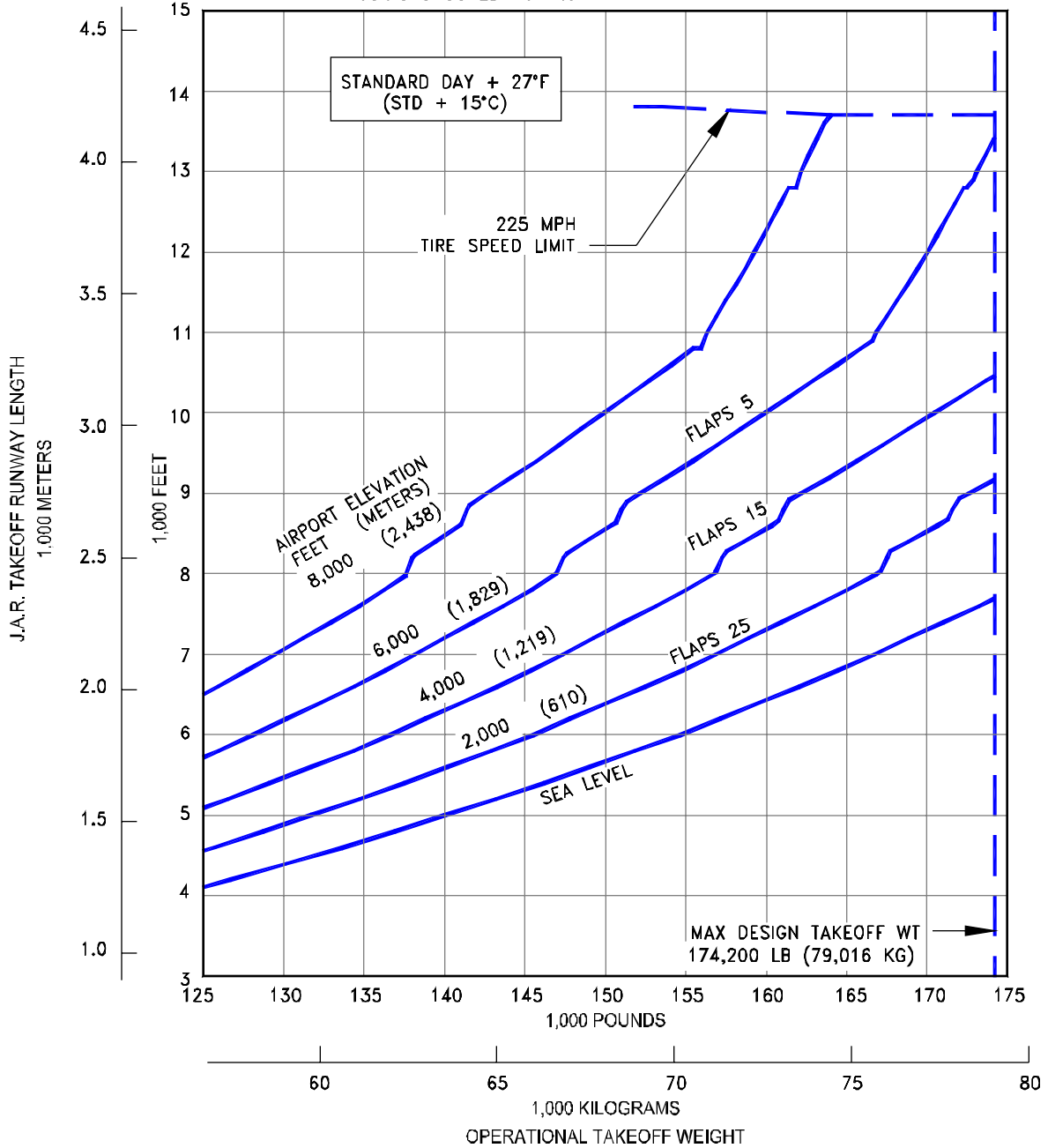

3.3.106 J.A.R. TAKEOFF RUNWAY LENGTH REQUIREMENTS

STANDARD DAY +27°F (STD + 15°C), WET RUNWAY

MODEL 737-800 WITH WINGLETS, (CFM56-7B27 ENGINES AT 27,300 LB SLST)

NOTES:

- CFM56-7B27 ENGINES AT 27,300 LB SLST
- NO ENGINE AIR BLEED FOR AIR CONDITIONING
- ZERO WIND, ZERO RUNWAY GRADIENT
- DRY RUNWAY SURFACE
- CONSULT WITH AIRCRAFT USER FOR SPECIFIC OPERATING PROCEDURE PRIOR TO FACILITY DESIGN

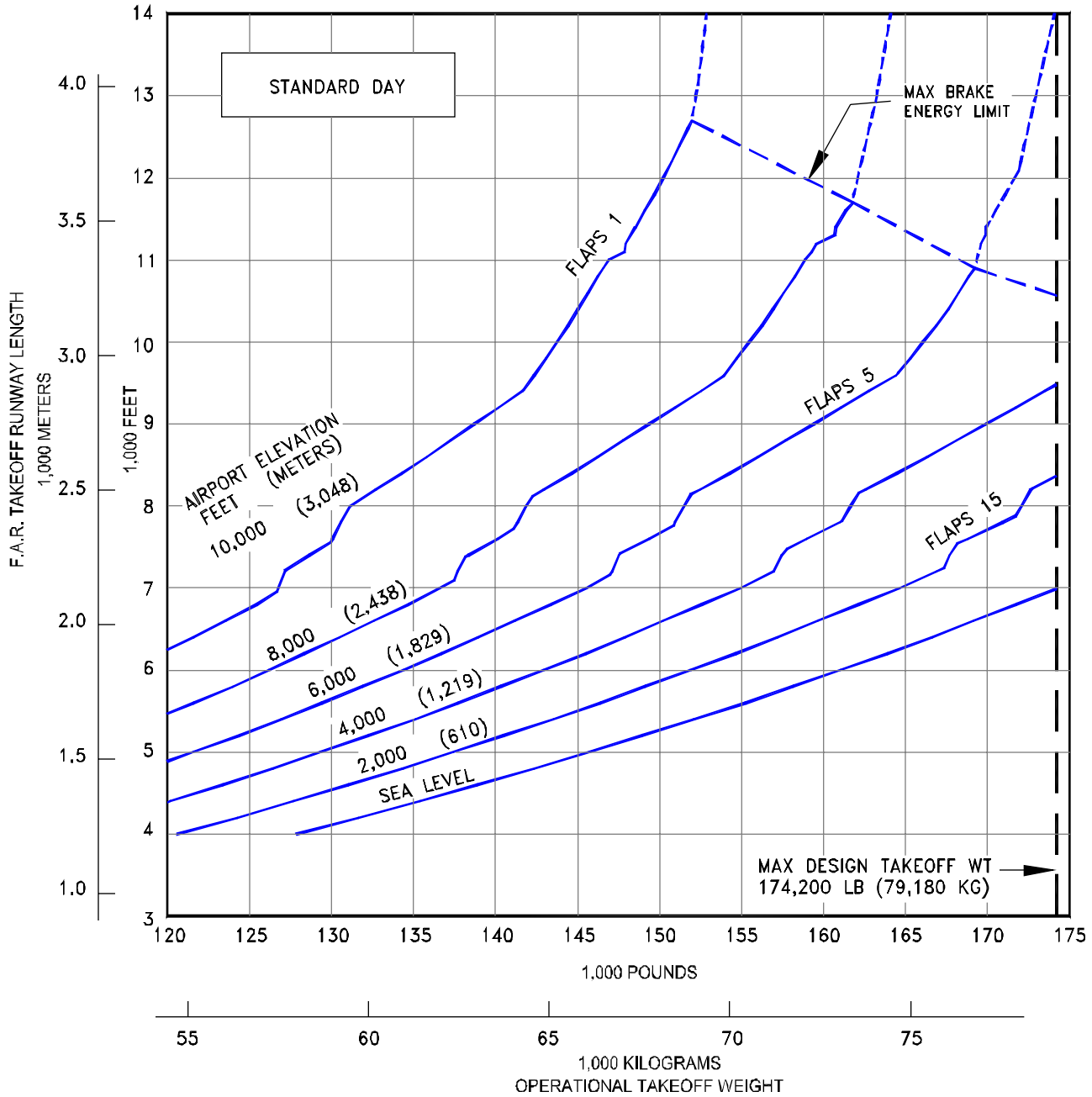

3.3.107 F.A.R TAKEOFF RUNWAY LENGTH REQUIREMENTS - STANDARD DAY

DRY RUNWAY

MODEL 737 BBJ2 (CFM56-7B27 ENGINES AT 27,300 LB SLST)

D6-58325-6

NOTES:

- CFM56-7B27 ENGINES AT 27,300 LB SLST
- NO ENGINE AIR BLEED FOR AIR CONDITIONING
- ZERO WIND, ZERO RUNWAY GRADIENT
- DRY RUNWAY SURFACE
- CONSULT WITH AIRCRAFT USER FOR SPECIFIC OPERATING PROCEDURE PRIOR TO FACILITY DESIGN

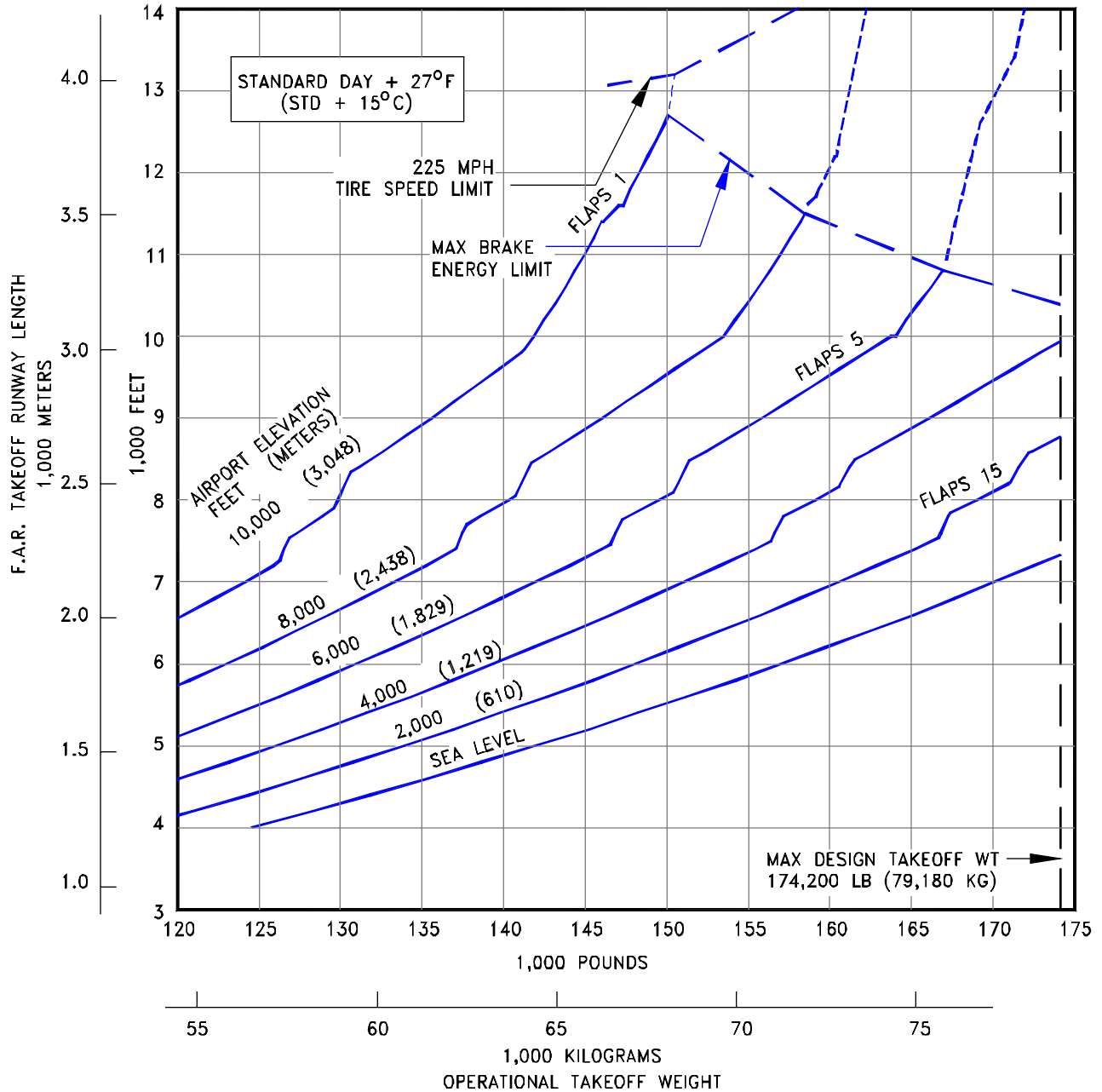

3.3.108 F.A.R TAKEOFF RUNWAY LENGTH REQUIREMENTS

STANDARD DAY +27°F (STD + 15°C), DRY RUNWAY

MODEL 737 BBJ2 (CFM56-7B27 ENGINES AT 27,300 LB SLST)

NOTES:

- CFM56-7B27 ENGINES AT 27,300 LB SLST
- NO ENGINE AIR BLEED FOR AIR CONDITIONING
- ZERO WIND, ZERO RUNWAY GRADIENT
- WET SMOOTH RUNWAY SURFACE
- CONSULT WITH AIRCRAFT USER FOR SPECIFIC OPERATING PROCEDURE PRIOR TO FACILITY DESIGN
- TAKEOFF PERFORMANCE IMPROVEMENTS ARE POSSIBLE USING GROOVED RUNWAY

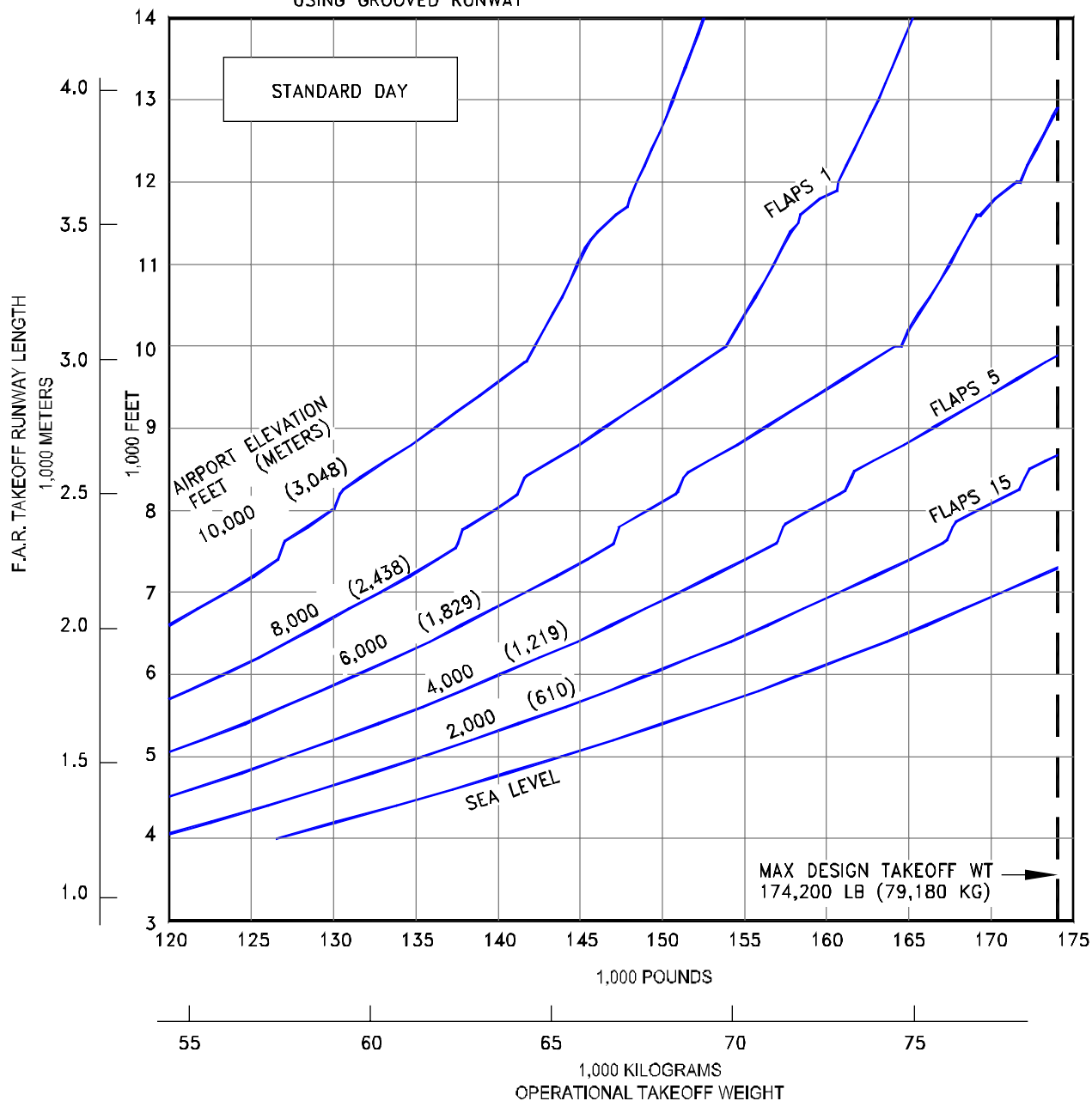

**3.3.109 J.A.R TAKEOFF RUNWAY LENGTH REQUIREMENTS - STANDARD DAY
WET RUNWAY**

MODEL 737 BBJ2 (CFM56-7B27 ENGINES AT 27,300 LB SLST)

NOTES:

- CFM56-7B27 ENGINES AT 27,300 LB SLST
- NO ENGINE AIR BLEED FOR AIR CONDITIONING
- ZERO WIND, ZERO RUNWAY GRADIENT
- WET SMOOTH RUNWAY SURFACE
- CONSULT WITH AIRCRAFT USER FOR SPECIFIC OPERATING PROCEDURE PRIOR TO FACILITY DESIGN
- TAKEOFF PERFORMANCE IMPROVEMENTS ARE POSSIBLE USING GROOVED RUNWAY

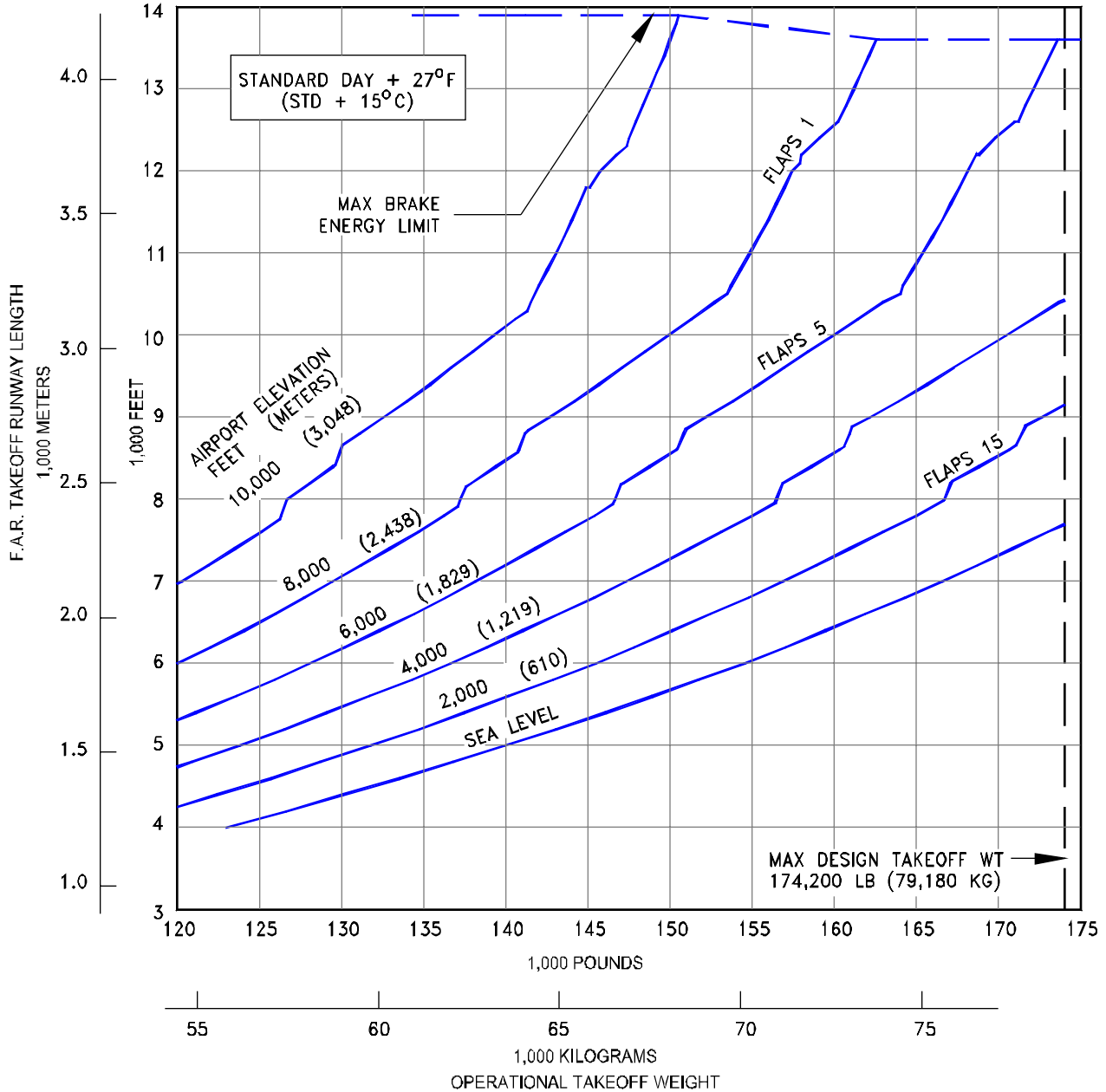

3.3.110 F.A.R TAKEOFF RUNWAY LENGTH REQUIREMENTS
STANDARD DAY +27°F (STD + 15°C), WET RUNWAY
MODEL 737 BBJ2 (CFM56-7B27 ENGINES AT 27,300 LB SLST)

NOTES:

- CFM56-7B24 ENGINES RATED AT 24,200 LB SLST
- NO ENGINE AIR BLEED FOR AIR CONDITIONING
- ZERO WIND, ZERO RUNWAY GRADIENT
- DRY RUNWAY SURFACE
- CONSULT WITH USING AIRLINE FOR SPECIFIC OPERATING PROCEDURE PRIOR TO FACILITY DESIGN

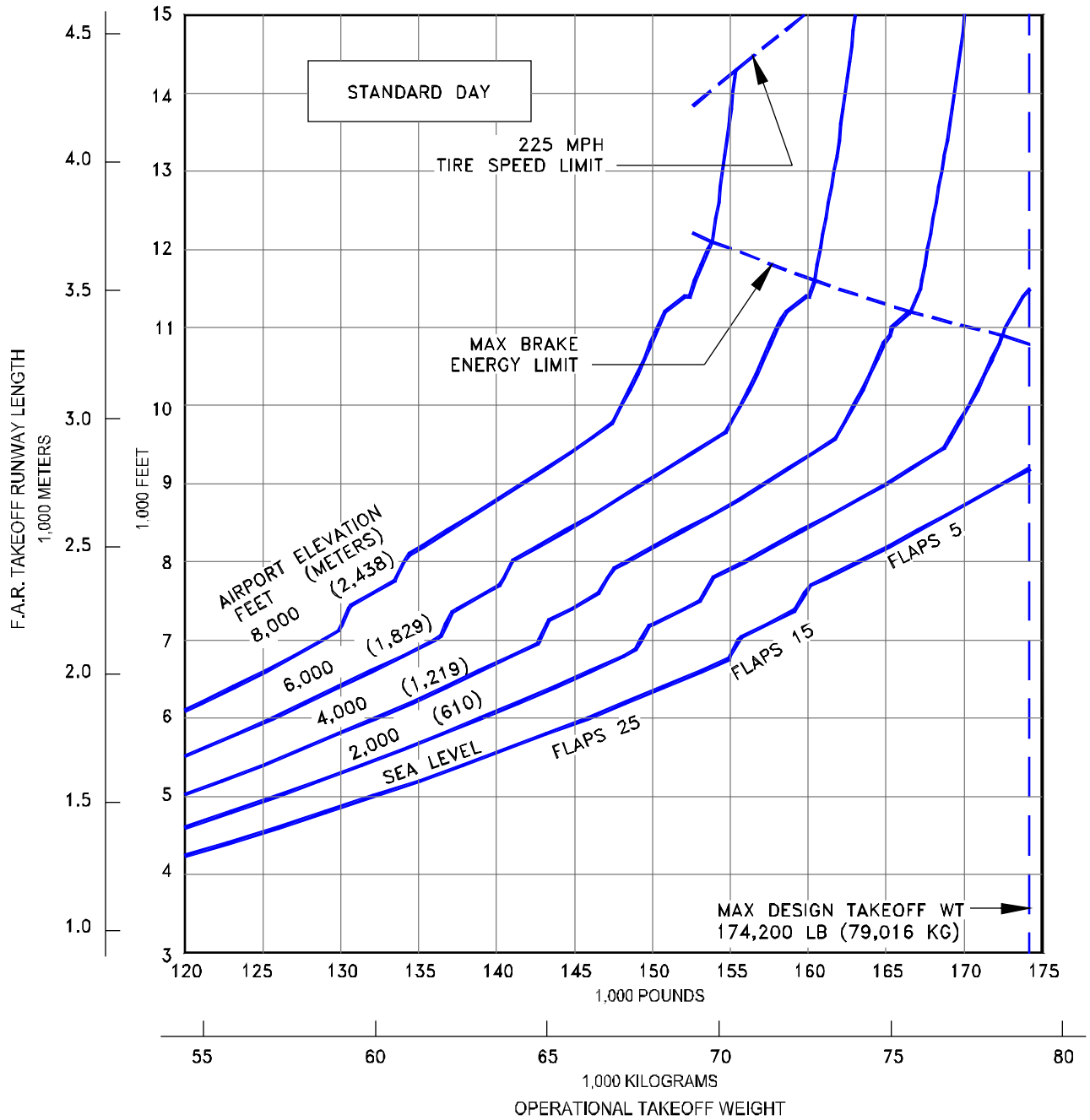

3.3.111 F.A.R. TAKEOFF RUNWAY LENGTH REQUIREMENTS
STANDARD DAY, DRY RUNWAY
MODEL 737-900 (CFM56-7B24 ENGINES AT 24,200 LB SLST)

D6-58325-6

NOTES:

- CFM56-7B24 ENGINES RATED AT 24,200 LB SLST
- NO ENGINE AIR BLEED FOR AIR CONDITIONING
- ZERO WIND, ZERO RUNWAY GRADIENT
- DRY RUNWAY SURFACE
- CONSULT WITH USING AIRLINE FOR SPECIFIC OPERATING PROCEDURE PRIOR TO FACILITY DESIGN

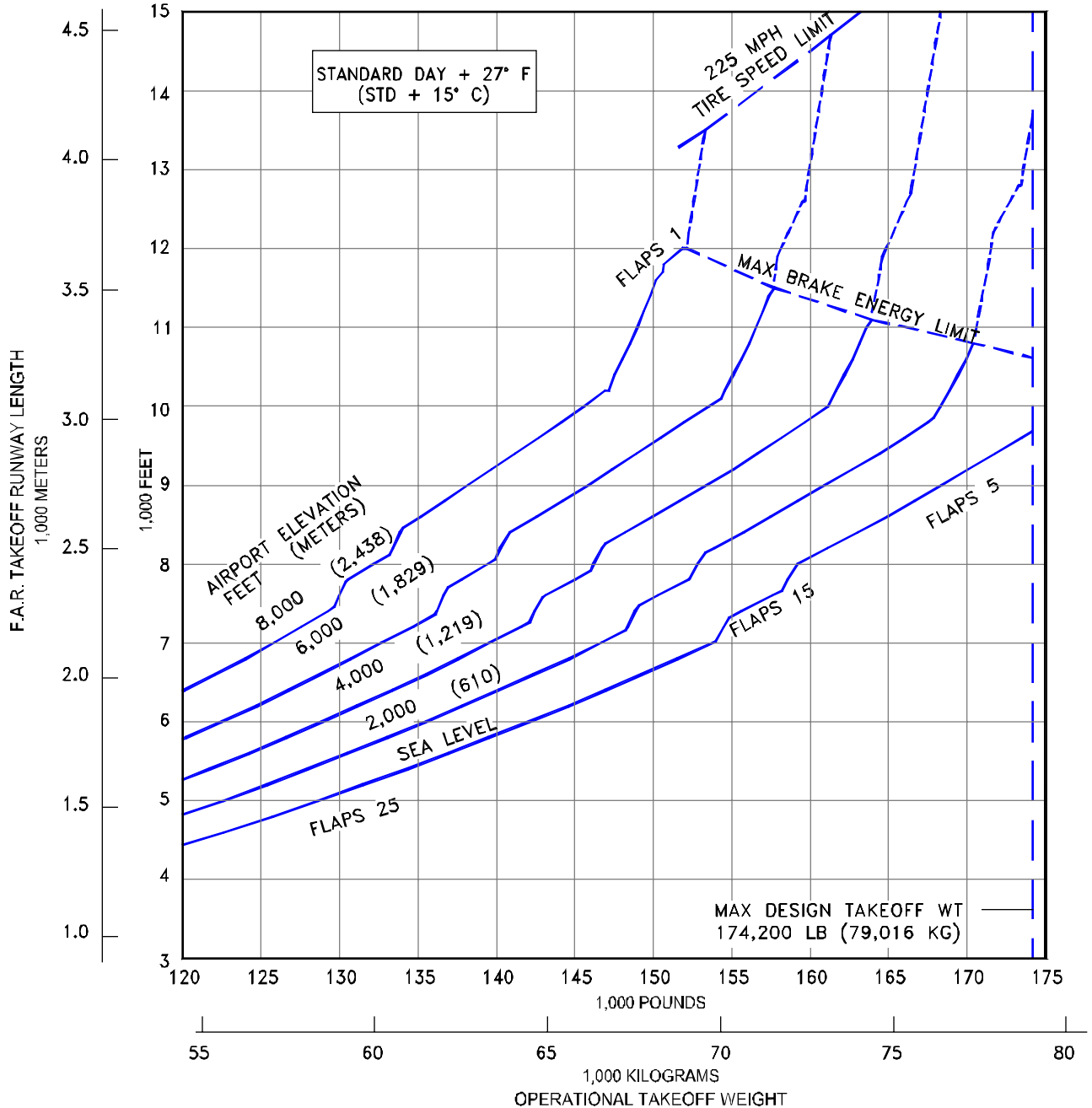

3.3.112 F.A.R. TAKEOFF RUNWAY LENGTH REQUIREMENTS

STANDARD DAY +27°F (STD + 15°C), DRY RUNWAY

MODEL 737-900 (CFM56-7B24 ENGINES AT 24,200 LB SLST)

NOTES:

- CFM56-7B24 ENGINES RATED AT 24,200 LB SLST
- NO ENGINE AIR BLEED FOR AIR CONDITIONING
- ZERO WIND, ZERO RUNWAY GRADIENT
- WET SMOOTH RUNWAY SURFACE
- CONSULT WITH USING AIRLINE FOR SPECIFIC OPERATING PROCEDURE PRIOR TO FACILITY DESIGN
- TAKEOFF PERFORMANCE IMPROVEMENTS ARE POSSIBLE USING GROOVED RUNWAY

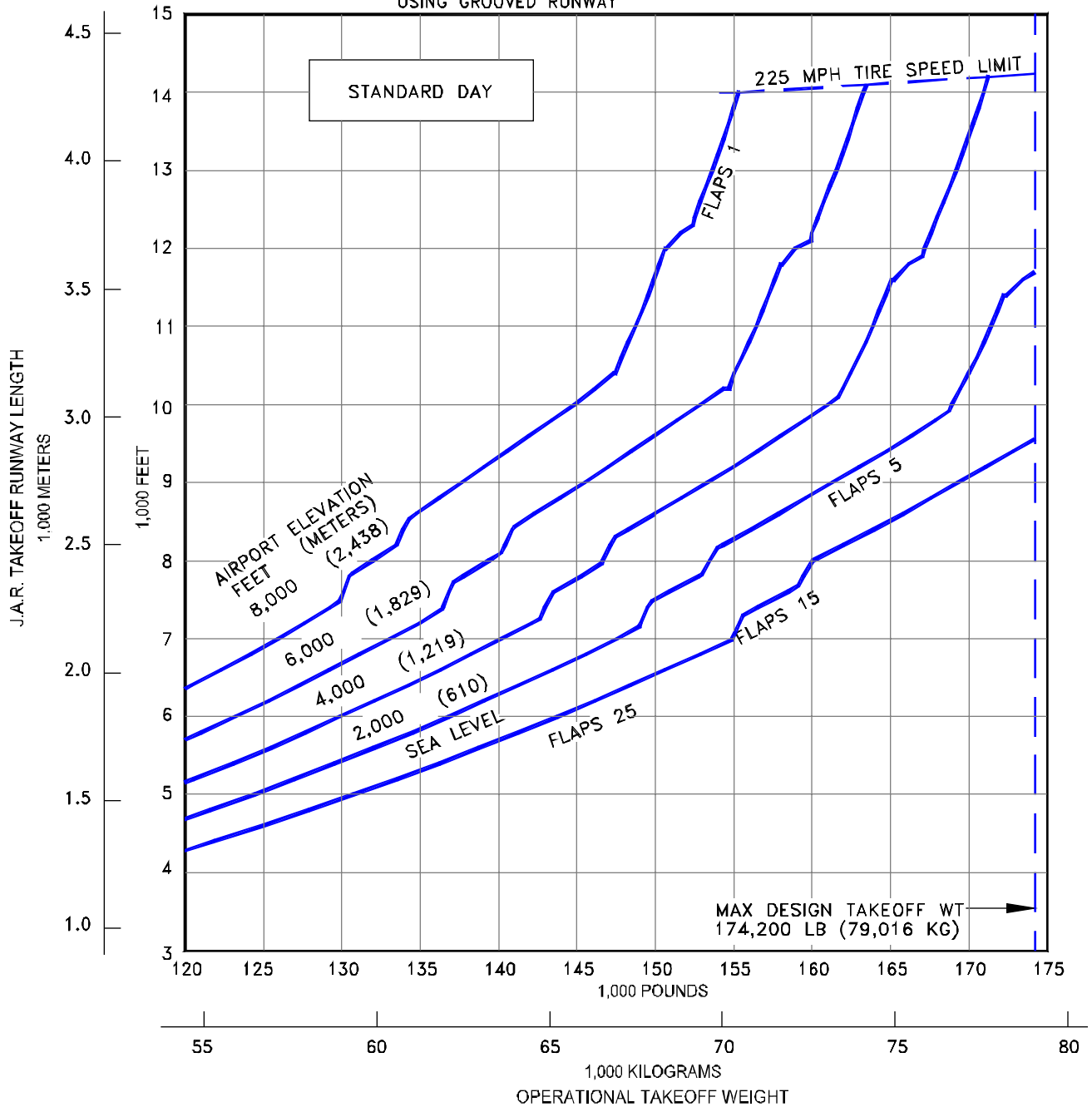

**3.3.113 J.A.R. TAKEOFF RUNWAY LENGTH REQUIREMENTS
STANDARD DAY, WET RUNWAY
MODEL 737-900 (CFM56-7B24 ENGINES AT 24,200 LB SLST)**

D6-58325-6

NOTES:

- CFM56-7B24 ENGINES RATED AT 24,200 LB SLST
- NO ENGINE AIR BLEED FOR AIR CONDITIONING
- ZERO WIND, ZERO RUNWAY GRADIENT
- WET SMOOTH RUNWAY SURFACE
- CONSULT WITH USING AIRLINE FOR SPECIFIC OPERATING PROCEDURE PRIOR TO FACILITY DESIGN
- TAKEOFF PERFORMANCE IMPROVEMENTS ARE POSSIBLE USING GROOVED RUNWAY

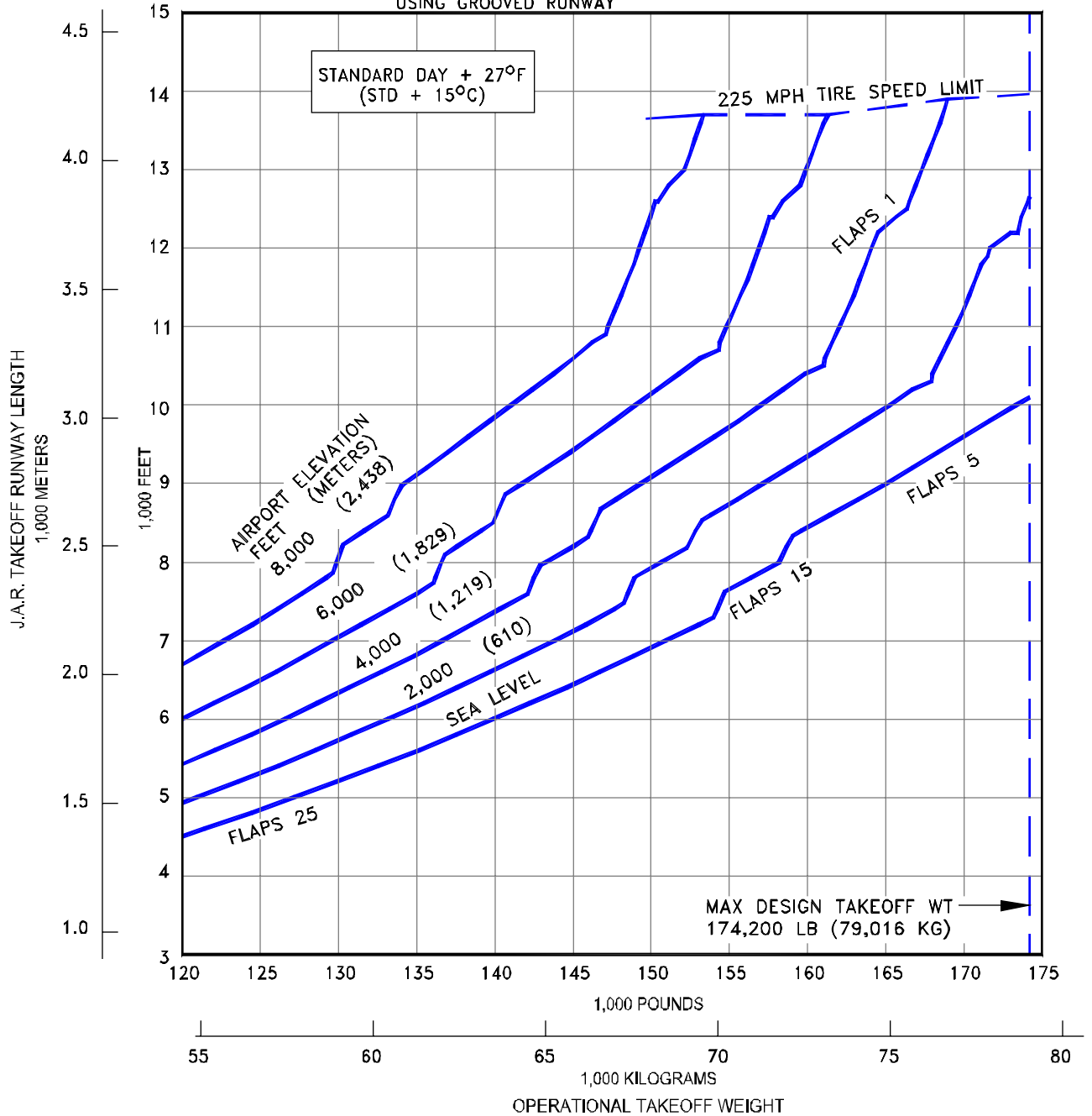

3.3.114 J.A.R. TAKEOFF RUNWAY LENGTH REQUIREMENTS

STANDARD DAY +27°F (STD + 15°C), WET RUNWAY
MODEL 737-900 (CFM56-7B24 ENGINES AT 24,200 LB SLST)

NOTES:

- CFM56-7B24 ENGINES RATED AT 24,200 LB SLST
- NO ENGINE AIR BLEED FOR AIR CONDITIONING
- ZERO WIND, ZERO RUNWAY GRADIENT
- DRY RUNWAY SURFACE
- CONSULT WITH USING AIRLINE FOR SPECIFIC OPERATING PROCEDURE PRIOR TO FACILITY DESIGN

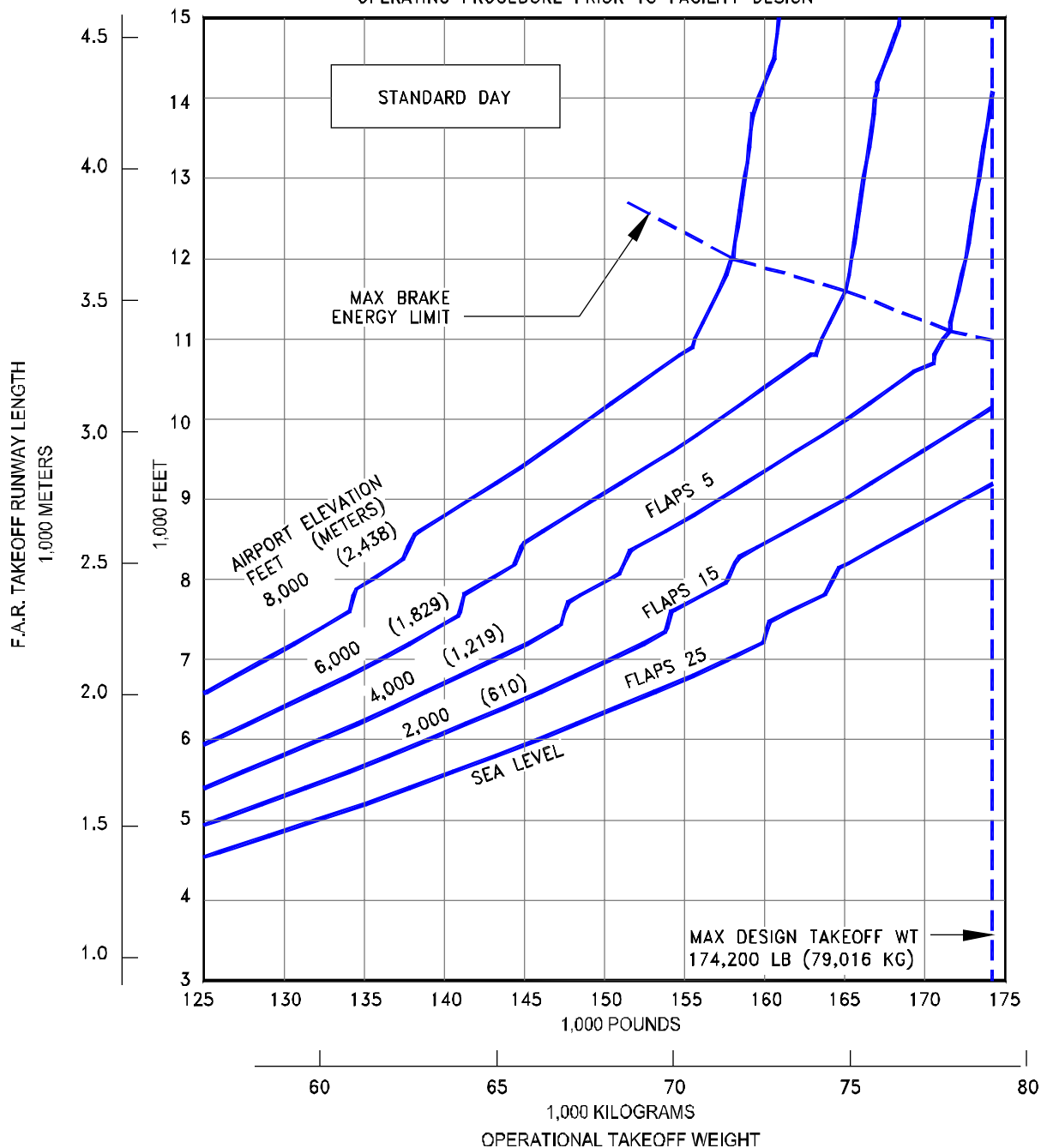

**3.3.115 F.A.R. TAKEOFF RUNWAY LENGTH REQUIREMENTS
STANDARD DAY, DRY RUNWAY**

MODEL 737-900 WITH WINGLETS (CFM56-7B24 ENGINES AT 24,200 LB SLST)

NOTES:

- CFM56-7B24 ENGINES RATED AT 24,200 LB SLST
- NO ENGINE AIR BLEED FOR AIR CONDITIONING
- ZERO WIND, ZERO RUNWAY GRADIENT
- DRY RUNWAY SURFACE
- CONSULT WITH USING AIRLINE FOR SPECIFIC OPERATING PROCEDURE PRIOR TO FACILITY DESIGN

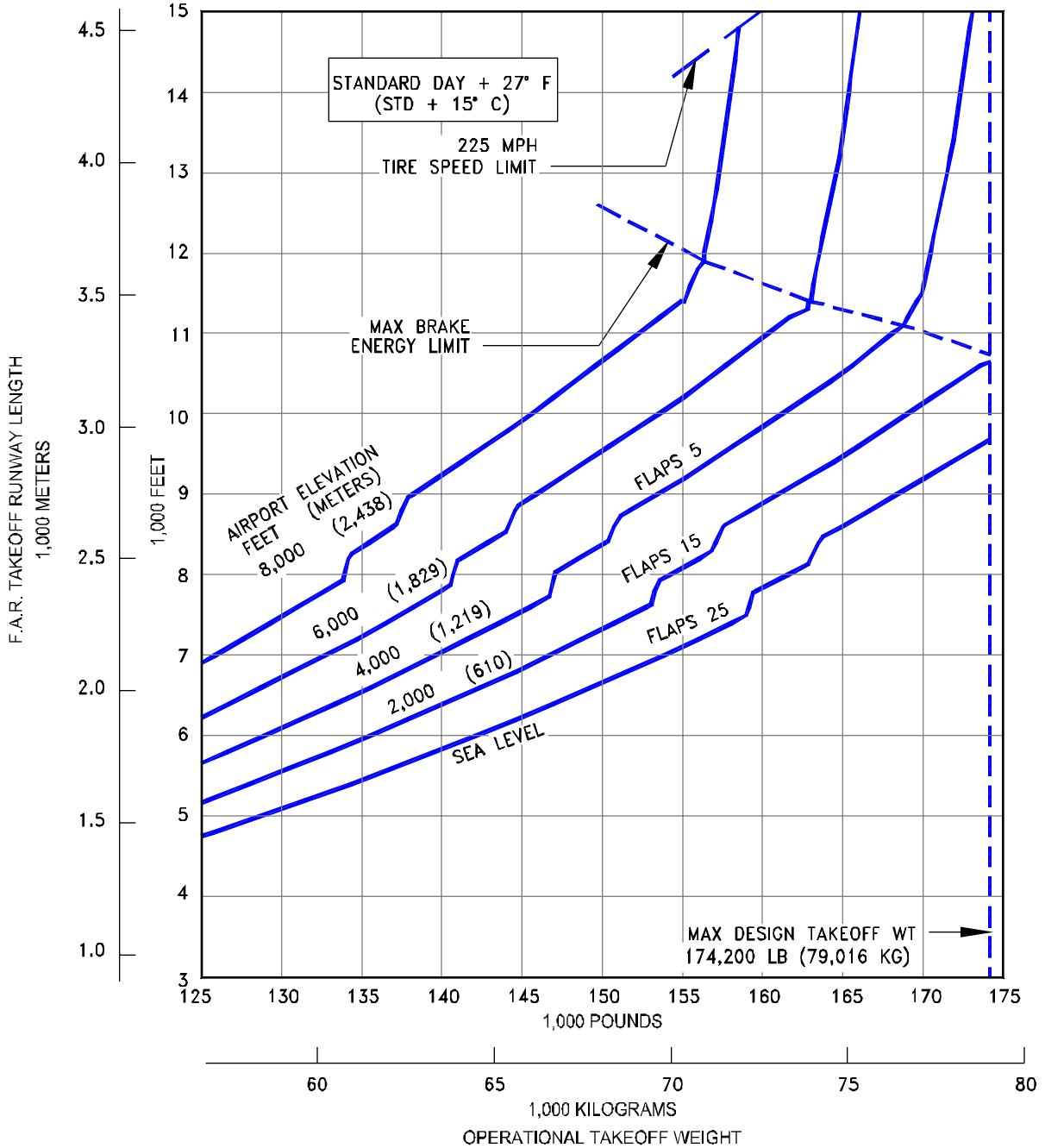

3.3.116 F.A.R. TAKEOFF RUNWAY LENGTH REQUIREMENTS

STANDARD DAY +27°F (STD + 15°C), DRY RUNWAY

MODEL 737-900 WITH WINGLETS (CFM56-7B24 ENGINES AT 24,200 LB SLST)

NOTES:

- CFM56-7B24 ENGINES RATED AT 24,200 LB SLST
- NO ENGINE AIR BLEED FOR AIR CONDITIONING
- ZERO WIND, ZERO RUNWAY GRADIENT
- WET SMOOTH RUNWAY SURFACE
- CONSULT WITH USING AIRLINE FOR SPECIFIC OPERATING PROCEDURE PRIOR TO FACILITY DESIGN
- TAKEOFF PERFORMANCE IMPROVEMENTS ARE POSSIBLE USING GROOVED RUNWAY

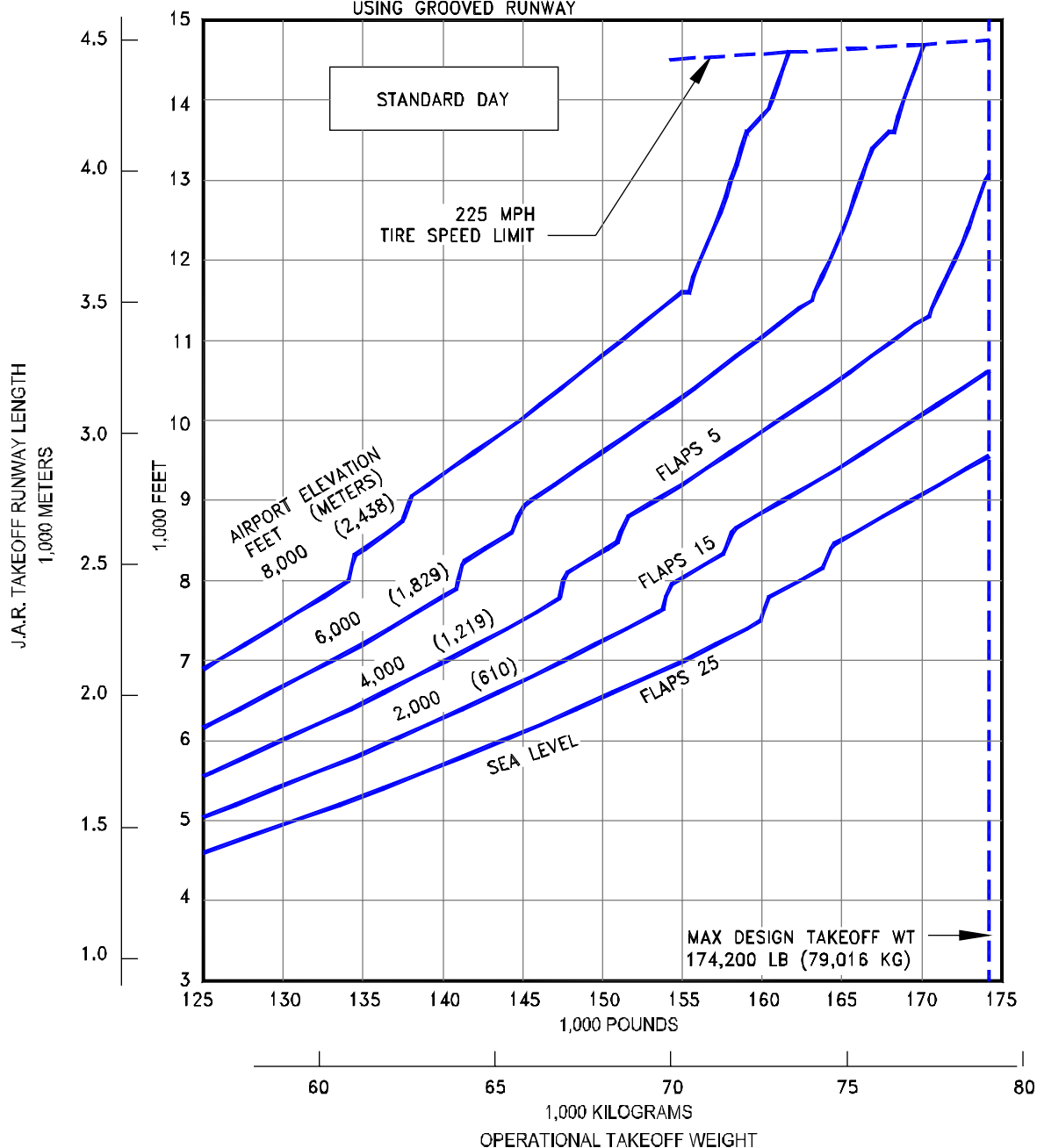

3.3.117 J.A.R. TAKEOFF RUNWAY LENGTH REQUIREMENTS

STANDARD DAY, WET RUNWAY

MODEL 737-900 WITH WINGLETS (CFM56-7B24 ENGINES AT 24,200 LB SLST)

D6-58325-6

NOTES:

- CFM56-7B24 ENGINES RATED AT 24,200 LB SLST
- NO ENGINE AIR BLEED FOR AIR CONDITIONING
- ZERO WIND, ZERO RUNWAY GRADIENT
- WET SMOOTH RUNWAY SURFACE
- CONSULT WITH USING AIRLINE FOR SPECIFIC OPERATING PROCEDURE PRIOR TO FACILITY DESIGN
- TAKEOFF PERFORMANCE IMPROVEMENTS ARE POSSIBLE USING GROOVED RUNWAY

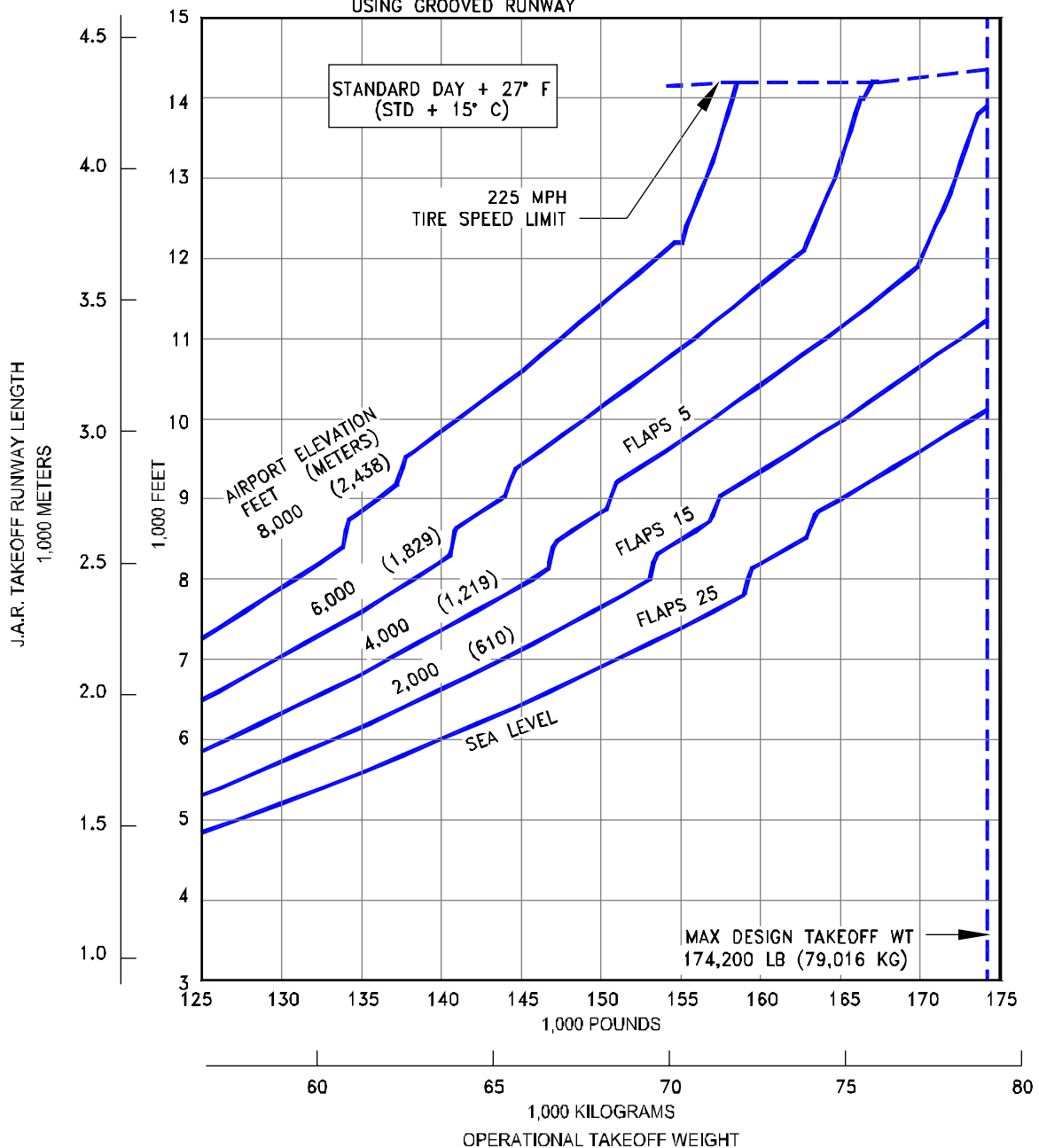

3.3.118 J.A.R. TAKEOFF RUNWAY LENGTH REQUIREMENTS

STANDARD DAY +27°F (STD + 15°C), WET RUNWAY

MODEL 737-900 WITH WINGLETS (CFM56-7B24 ENGINES AT 24,200 LB SLST)

NOTES:

- CFM56-7B26 ENGINES RATED AT 26,300 LB SLST
- NO ENGINE AIR BLEED FOR AIR CONDITIONING
- ZERO WIND, ZERO RUNWAY GRADIENT
- DRY RUNWAY SURFACE
- CONSULT WITH USING AIRLINE FOR SPECIFIC OPERATING PROCEDURE PRIOR TO FACILITY DESIGN
- TAKEOFF PERFORMANCE IMPROVEMENTS ARE POSSIBLE USING GROOVED RUNWAY

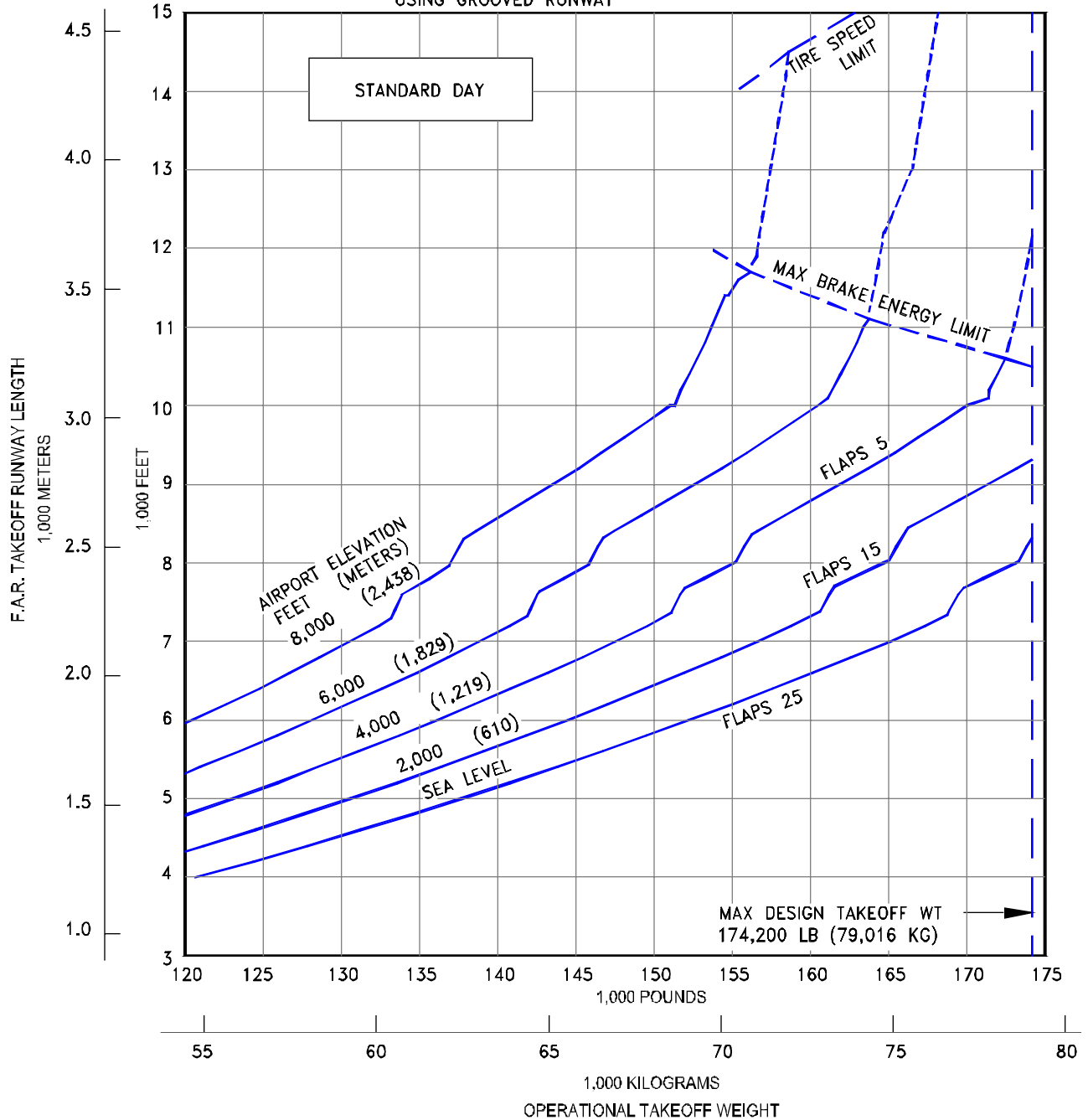

3.3.119 F.A.R. TAKEOFF RUNWAY LENGTH REQUIREMENTS
STANDARD DAY, DRY RUNWAY
MODEL 737-900 (CFM56-7B26 ENGINES AT 26,300 LB SLST)

D6-58325-6

NOTES:

- CFM56-7B26 ENGINES RATED AT 26,300 LB SLST
- NO ENGINE AIR BLEED FOR AIR CONDITIONING
- ZERO WIND, ZERO RUNWAY GRADIENT
- DRY RUNWAY SURFACE
- CONSULT WITH USING AIRLINE FOR SPECIFIC OPERATING PROCEDURE PRIOR TO FACILITY DESIGN
- TAKEOFF PERFORMANCE IMPROVEMENTS ARE POSSIBLE USING GROOVED RUNWAY

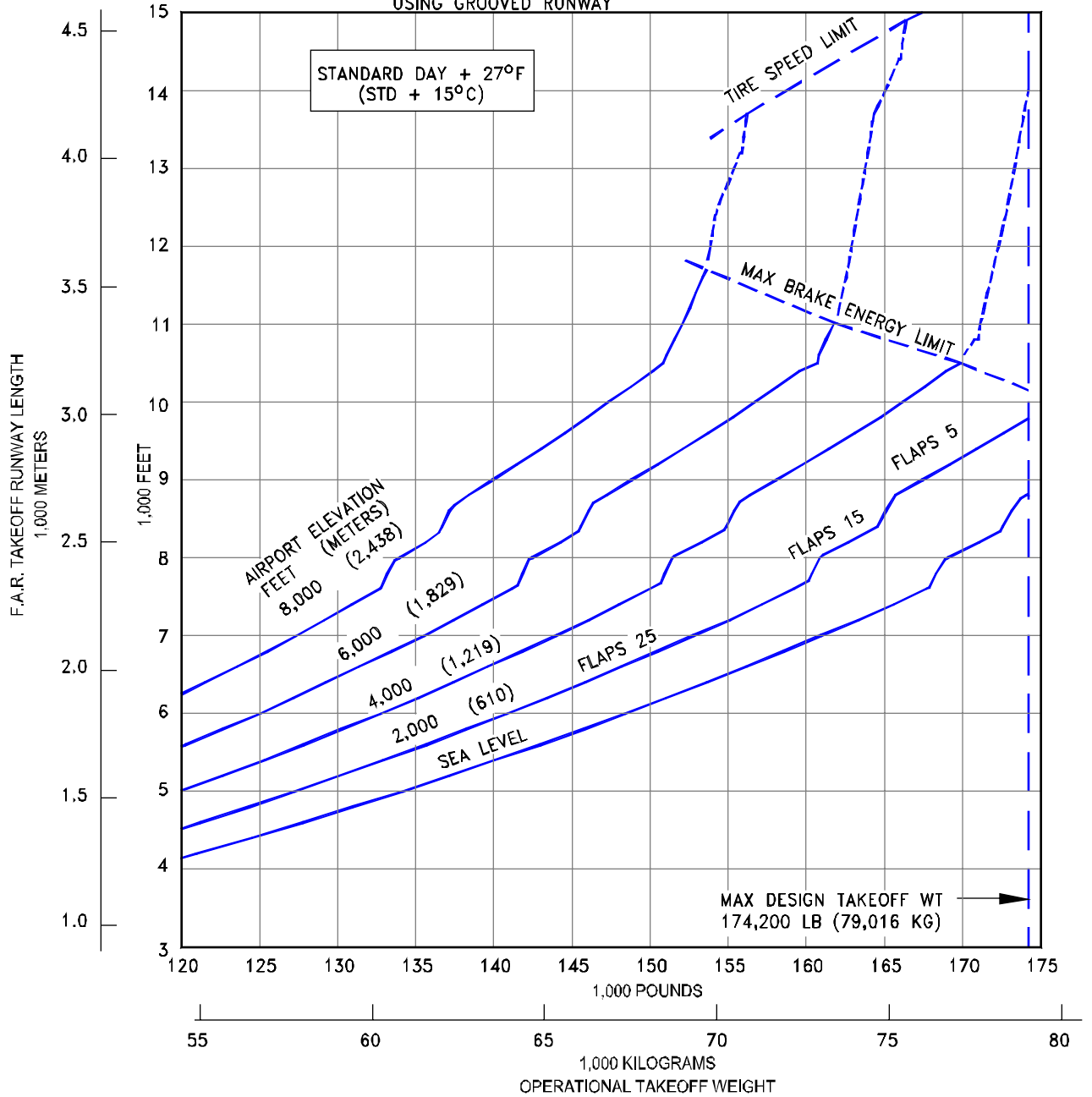

3.3.120 F.A.R. TAKEOFF RUNWAY LENGTH REQUIREMENTS

STANDARD DAY +27°F (STD + 15°C), DRY RUNWAY
 MODEL 737-900 (CFM56-7B26 ENGINES AT 26,300 LB SLST)

NOTES:

- CFM56-7B26 ENGINES RATED AT 26,300 LB SLST
- NO ENGINE AIR BLEED FOR AIR CONDITIONING
- ZERO WIND, ZERO RUNWAY GRADIENT
- WET SMOOTH RUNWAY SURFACE
- CONSULT WITH USING AIRLINE FOR SPECIFIC OPERATING PROCEDURE PRIOR TO FACILITY DESIGN
- TAKEOFF PERFORMANCE IMPROVEMENTS ARE POSSIBLE USING GROOVED RUNWAY

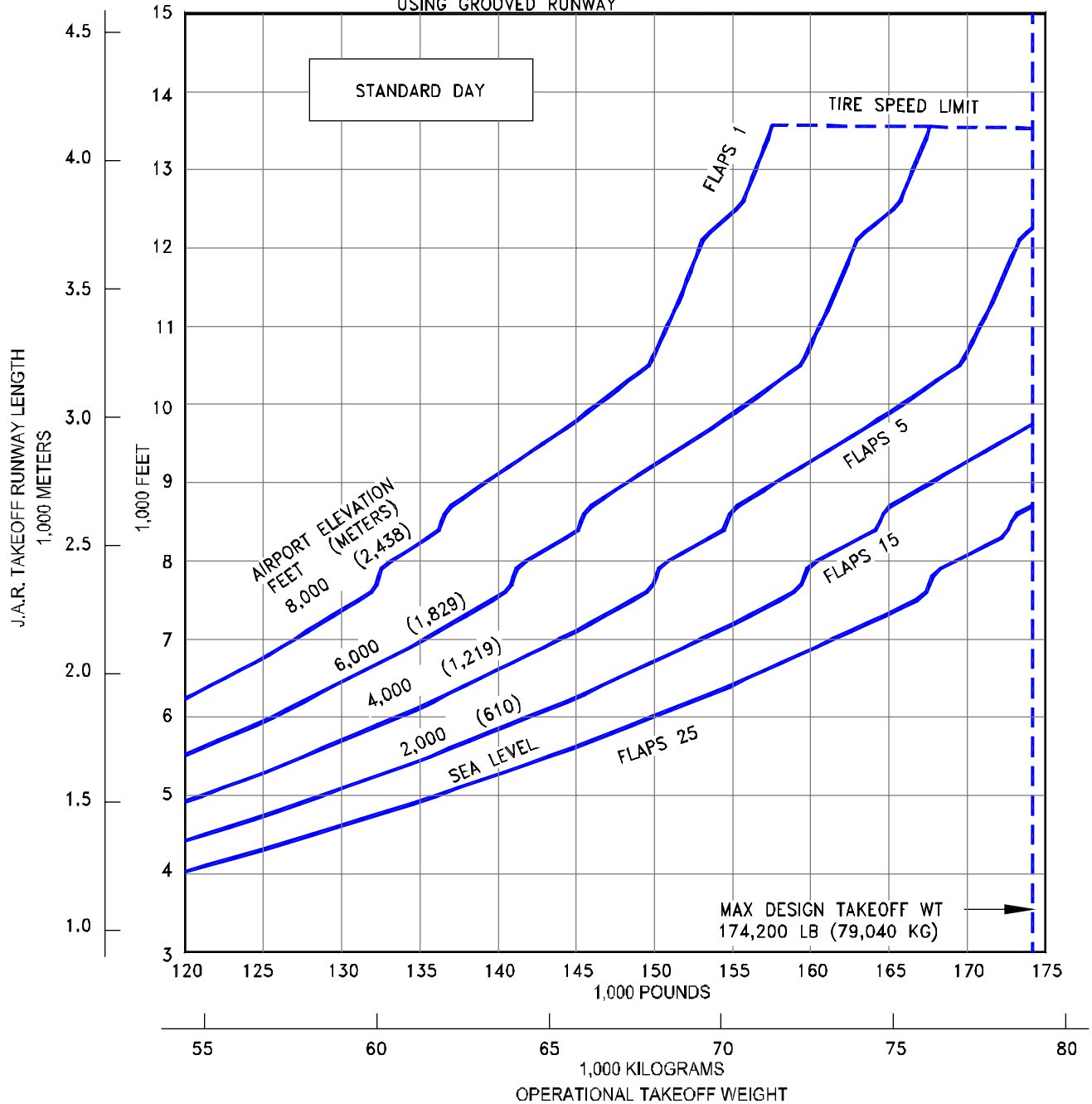

3.3.121 J.A.R. TAKEOFF RUNWAY LENGTH REQUIREMENTS
STANDARD DAY, WET RUNWAY
MODEL 737-900 (CFM56-7B26 ENGINES AT 26,300 LB SLST)

D6-58325-6

NOTES:

- CFM56-7B26 ENGINES RATED AT 26,300 LB SLST
- NO ENGINE AIR BLEED FOR AIR CONDITIONING
- ZERO WIND, ZERO RUNWAY GRADIENT
- WET SMOOTH RUNWAY SURFACE
- CONSULT WITH USING AIRLINE FOR SPECIFIC OPERATING PROCEDURE PRIOR TO FACILITY DESIGN
- TAKEOFF PERFORMANCE IMPROVEMENTS ARE POSSIBLE USING GROOVED RUNWAY

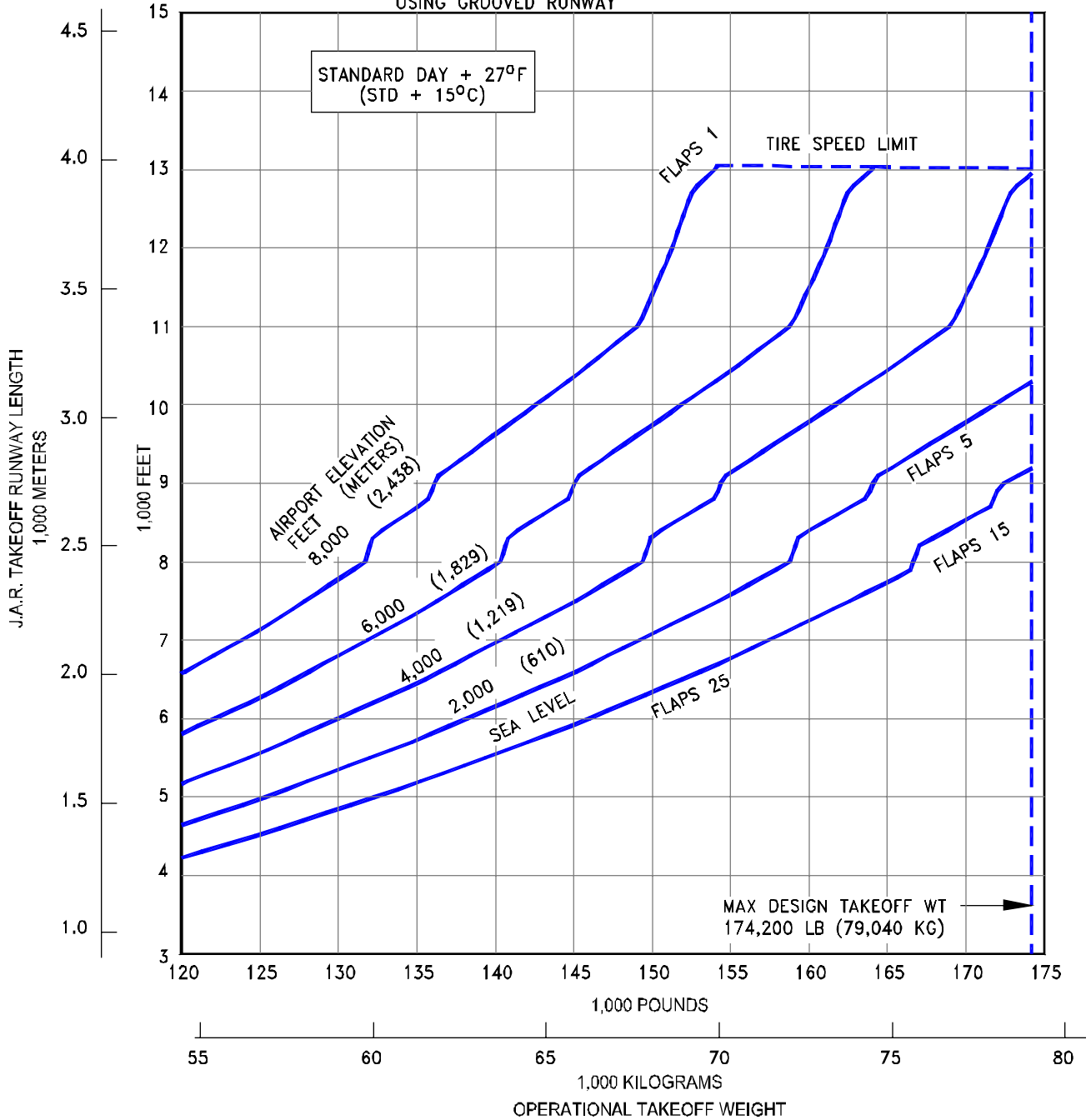

3.3.122 J.A.R. TAKEOFF RUNWAY LENGTH REQUIREMENTS

STANDARD DAY +27°F (STD + 15°C), WET RUNWAY

MODEL 737-900 (CFM56-7B26 ENGINES AT 26,300 LB SLST)

NOTES:

- CFM56-7B26 ENGINES RATED AT 26,300 LB SLST
- NO ENGINE AIR BLEED FOR AIR CONDITIONING
- ZERO WIND, ZERO RUNWAY GRADIENT
- DRY RUNWAY SURFACE
- CONSULT WITH USING AIRLINE FOR SPECIFIC OPERATING PROCEDURE PRIOR TO FACILITY DESIGN

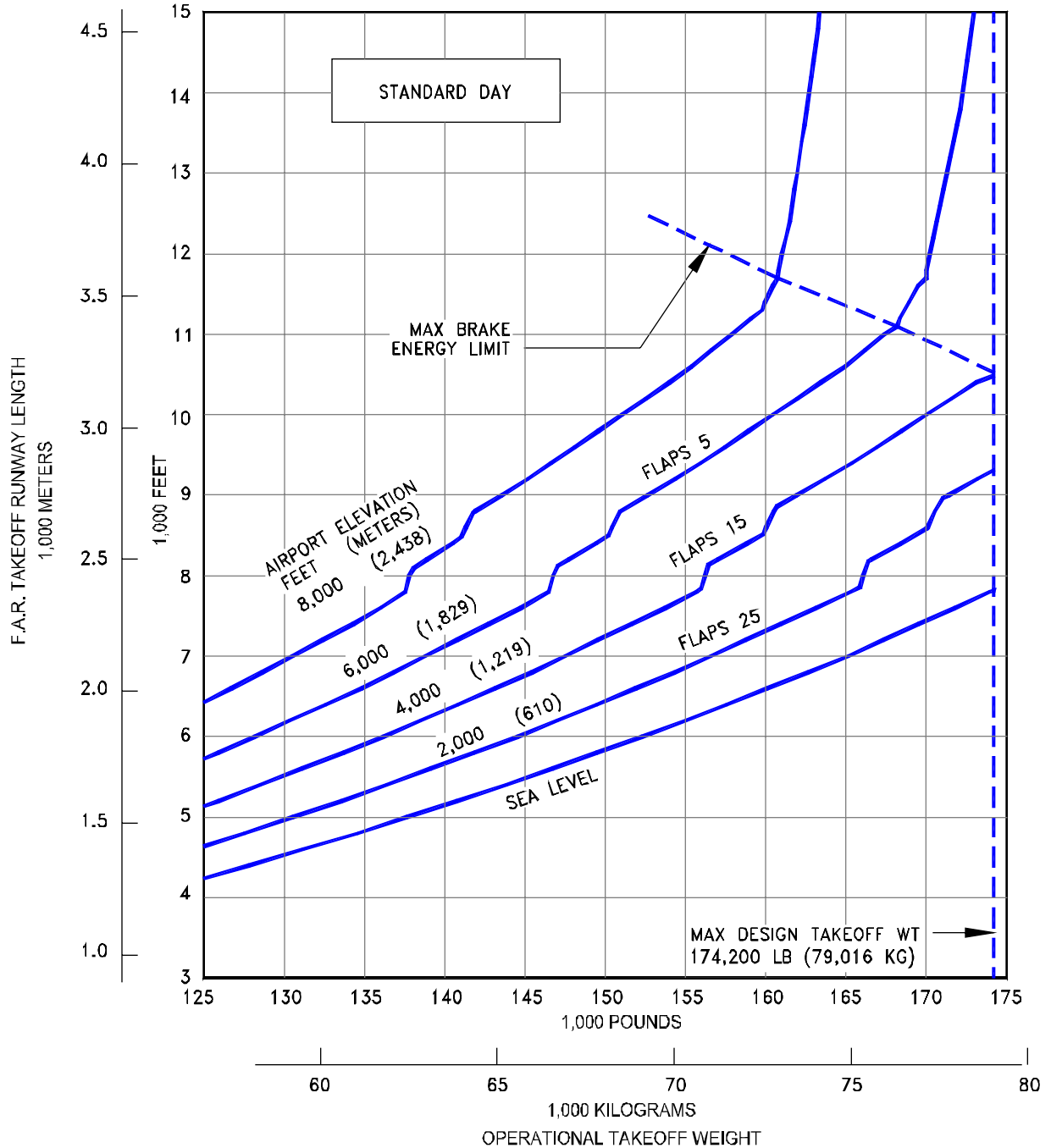

3.3.123 F.A.R. TAKEOFF RUNWAY LENGTH REQUIREMENTS

STANDARD DAY, DRY RUNWAY

MODEL 737-900 WITH WINGLETS (CFM56-7B26 ENGINES AT 26,300 LB SLST)

D6-58325-6

NOTES:

- CFM56-7B26 ENGINES RATED AT 26,300 LB SLST
- NO ENGINE AIR BLEED FOR AIR CONDITIONING
- ZERO WIND, ZERO RUNWAY GRADIENT
- DRY RUNWAY SURFACE
- CONSULT WITH USING AIRLINE FOR SPECIFIC OPERATING PROCEDURE PRIOR TO FACILITY DESIGN

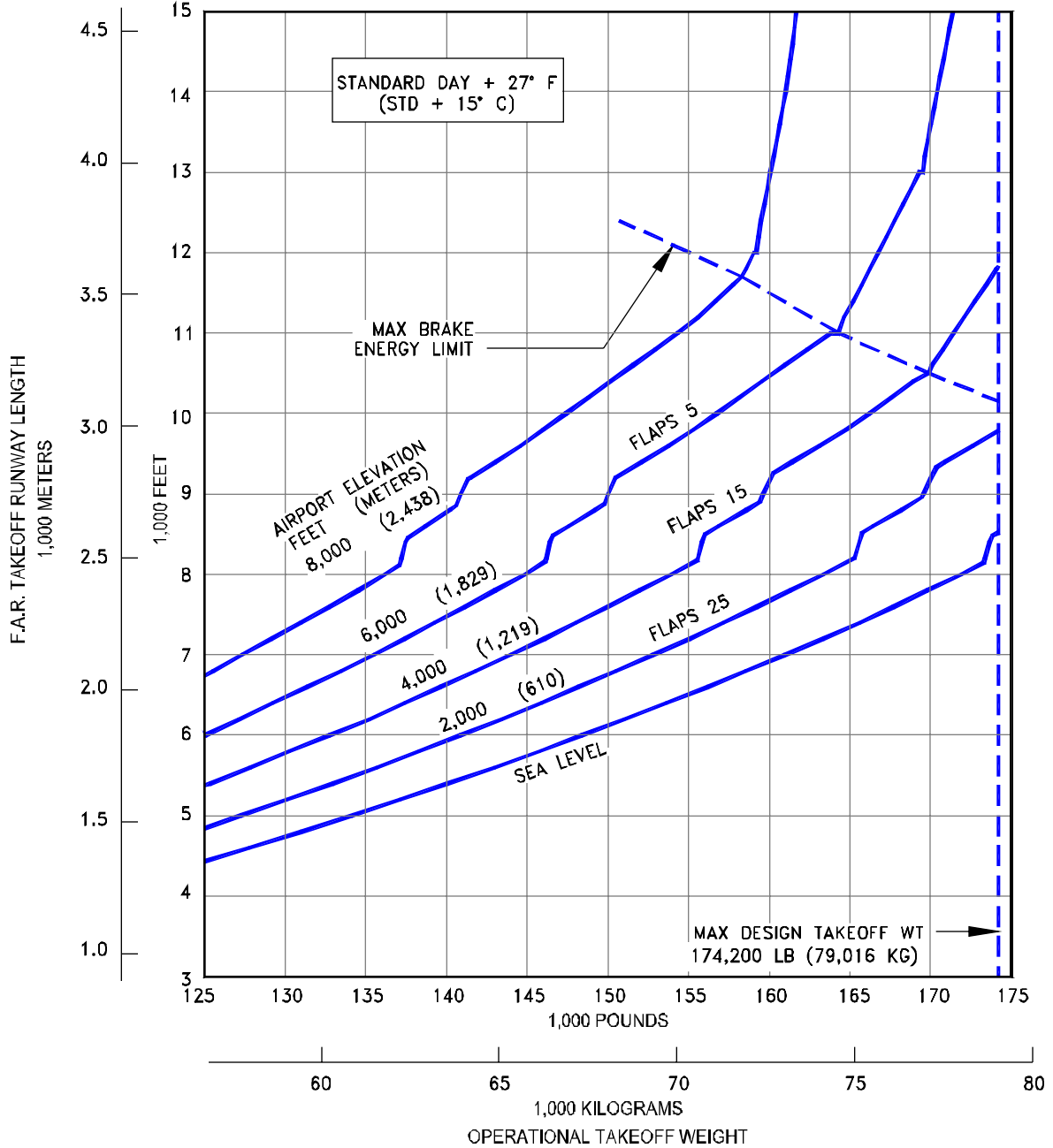

3.3.124 F.A.R. TAKEOFF RUNWAY LENGTH REQUIREMENTS

STANDARD DAY +27°F (STD + 15°C), DRY RUNWAY

MODEL 737-900 WITH WINGLETS (CFM56-7B26 ENGINES AT 26,300 LB SLST)

NOTES:

- ◆ CFM56-7B26 ENGINES RATED AT 26,300 LB SLST
- ◆ NO ENGINE AIR BLEED FOR AIR CONDITIONING
- ◆ ZERO WIND, ZERO RUNWAY GRADIENT
- ◆ WET SMOOTH RUNWAY SURFACE
- ◆ CONSULT WITH USING AIRLINE FOR SPECIFIC OPERATING PROCEDURE PRIOR TO FACILITY DESIGN
- ◆ TAKEOFF PERFORMANCE IMPROVEMENTS ARE POSSIBLE USING GROOVED RUNWAY

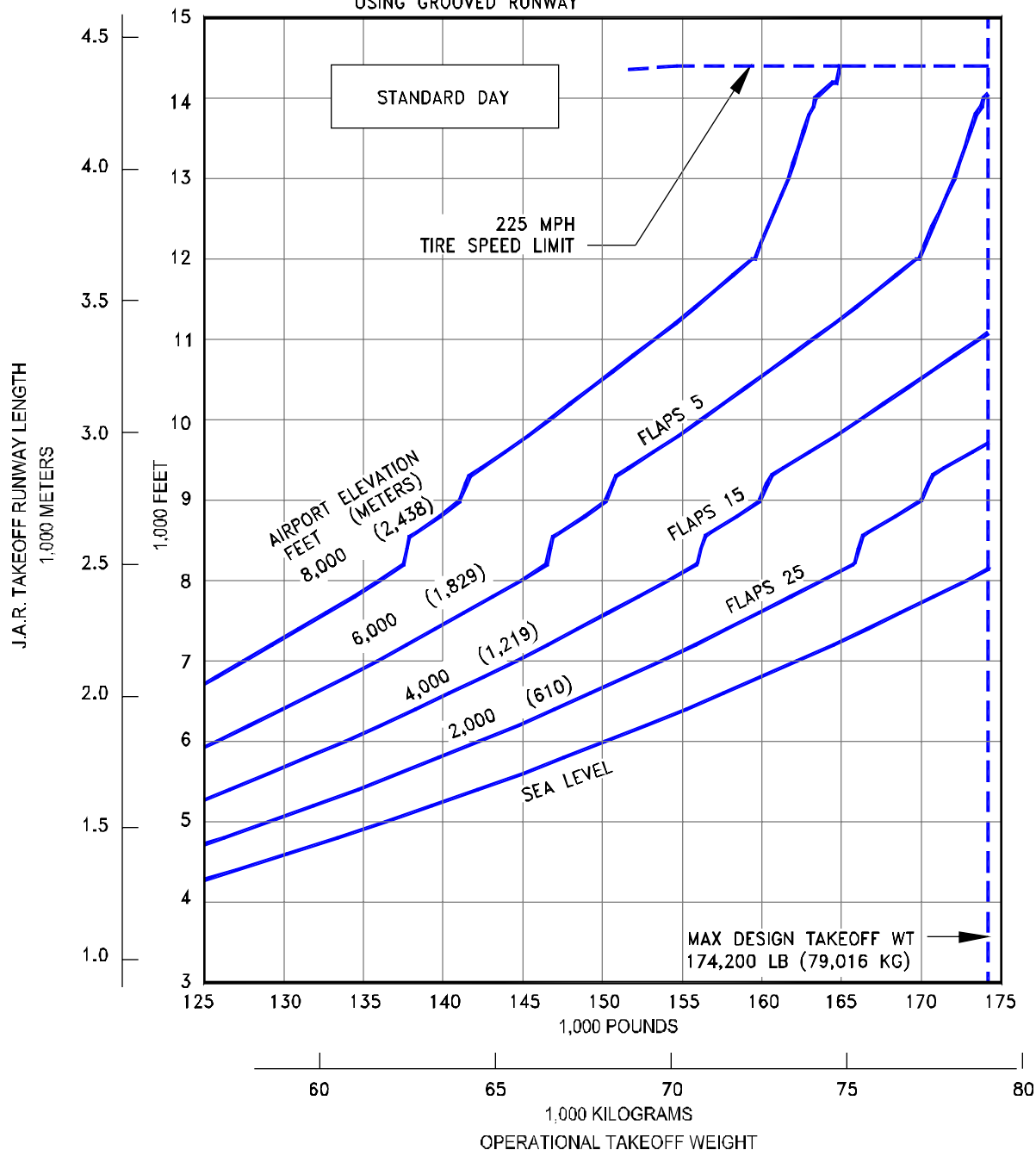

3.3.125 J.A.A. TAKEOFF RUNWAY LENGTH REQUIREMENTS

STANDARD DAY, WET RUNWAY

MODEL 737-900 WITH WINGLETS (CFM56-7B26 ENGINES AT 26,300 LB SLST)

NOTES:

- CFM56-7B26 ENGINES RATED AT 26,300 LB SLST
- NO ENGINE AIR BLEED FOR AIR CONDITIONING
- ZERO WIND, ZERO RUNWAY GRADIENT
- WET SMOOTH RUNWAY SURFACE
- CONSULT WITH USING AIRLINE FOR SPECIFIC OPERATING PROCEDURE PRIOR TO FACILITY DESIGN
- TAKEOFF PERFORMANCE IMPROVEMENTS ARE POSSIBLE USING GROOVED RUNWAY

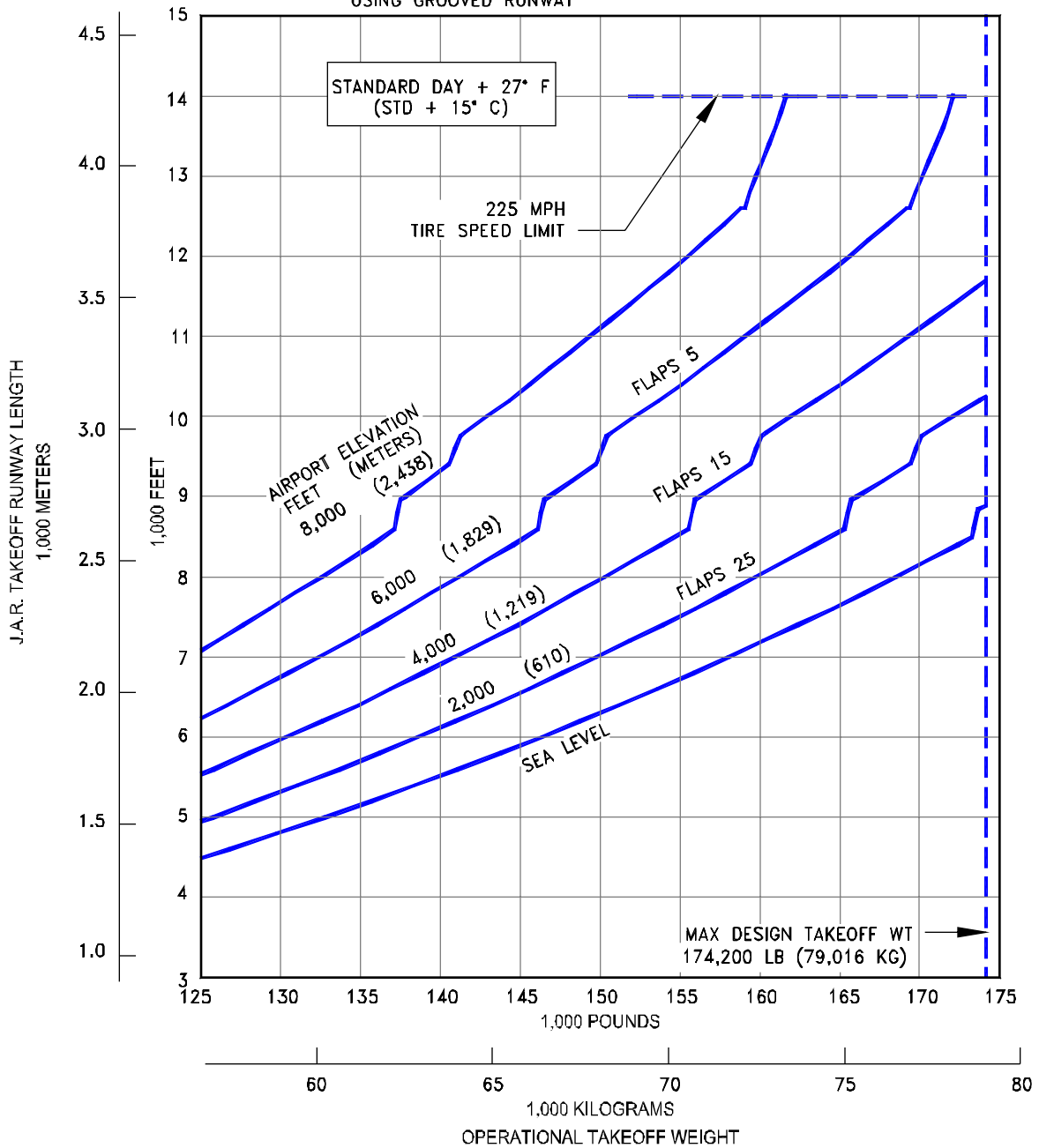

3.3.126 J.A.A. TAKEOFF RUNWAY LENGTH REQUIREMENTS

STANDARD DAY +27°F (STD + 15°C), WET RUNWAY

MODEL 737-900 WITH WINGLETS (CFM56-7B26 ENGINES AT 26,300 LB SLST)

NOTES:

- CFM56-7B27 ENGINES RATED AT 27,300 LB SLST
- NO ENGINE AIR BLEED FOR AIR CONDITIONING
- ZERO WIND, ZERO RUNWAY GRADIENT
- DRY RUNWAY SURFACE
- CONSULT WITH USING AIRLINE FOR SPECIFIC OPERATING PROCEDURE PRIOR TO FACILITY DESIGN

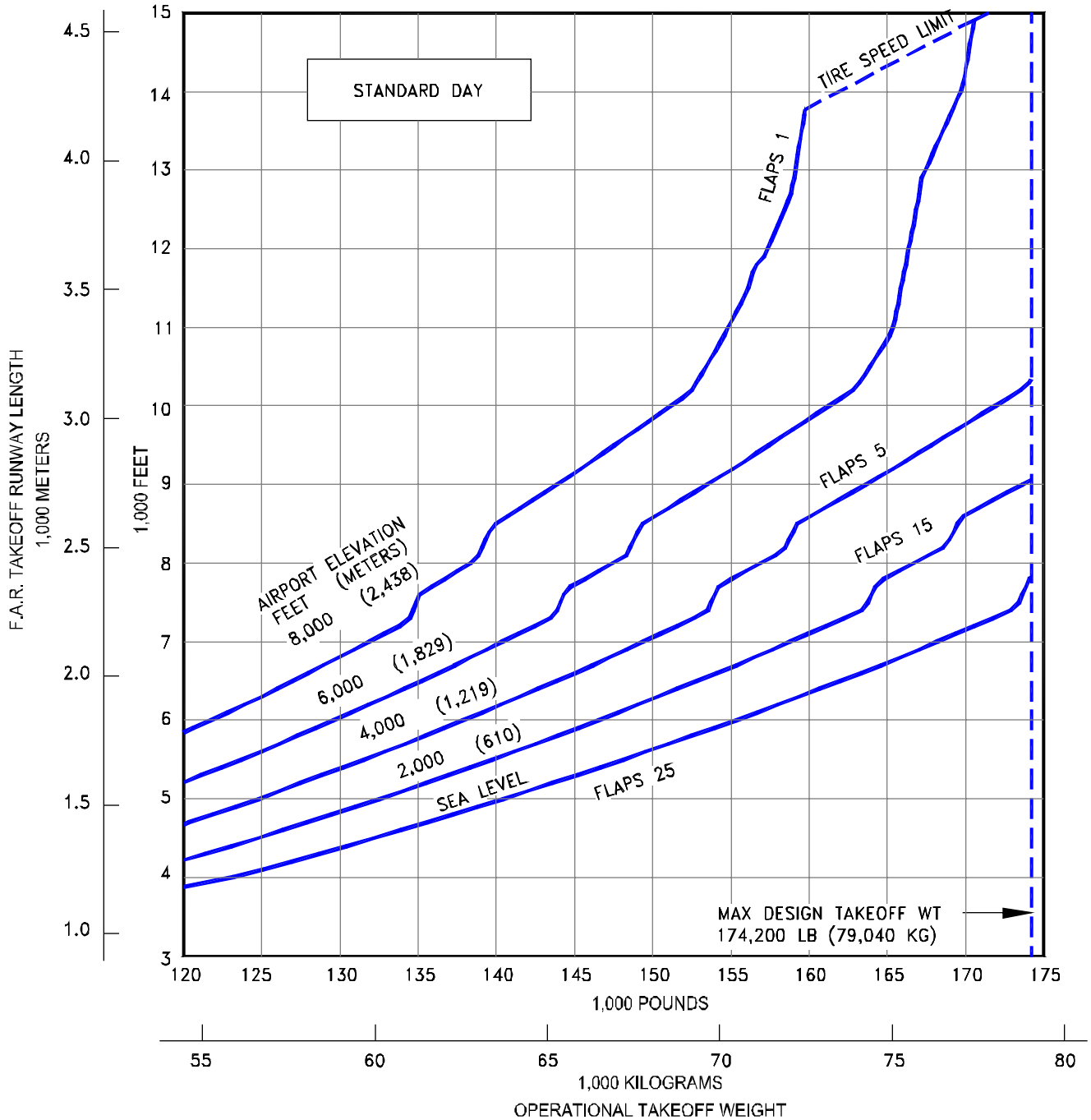

3.3.127 F.A.R. TAKEOFF RUNWAY LENGTH REQUIREMENTS
STANDARD DAY, DRY RUNWAY
MODEL 737-900 (CFM56-7B27 ENGINES AT 27,300 LB SLST)

D6-58325-6

NOTES:

- CFM56-7B27 ENGINES RATED AT 27,300 LB SLST
- NO ENGINE AIR BLEED FOR AIR CONDITIONING
- ZERO WIND, ZERO RUNWAY GRADIENT
- DRY RUNWAY SURFACE
- CONSULT WITH USING AIRLINE FOR SPECIFIC OPERATING PROCEDURE PRIOR TO FACILITY DESIGN

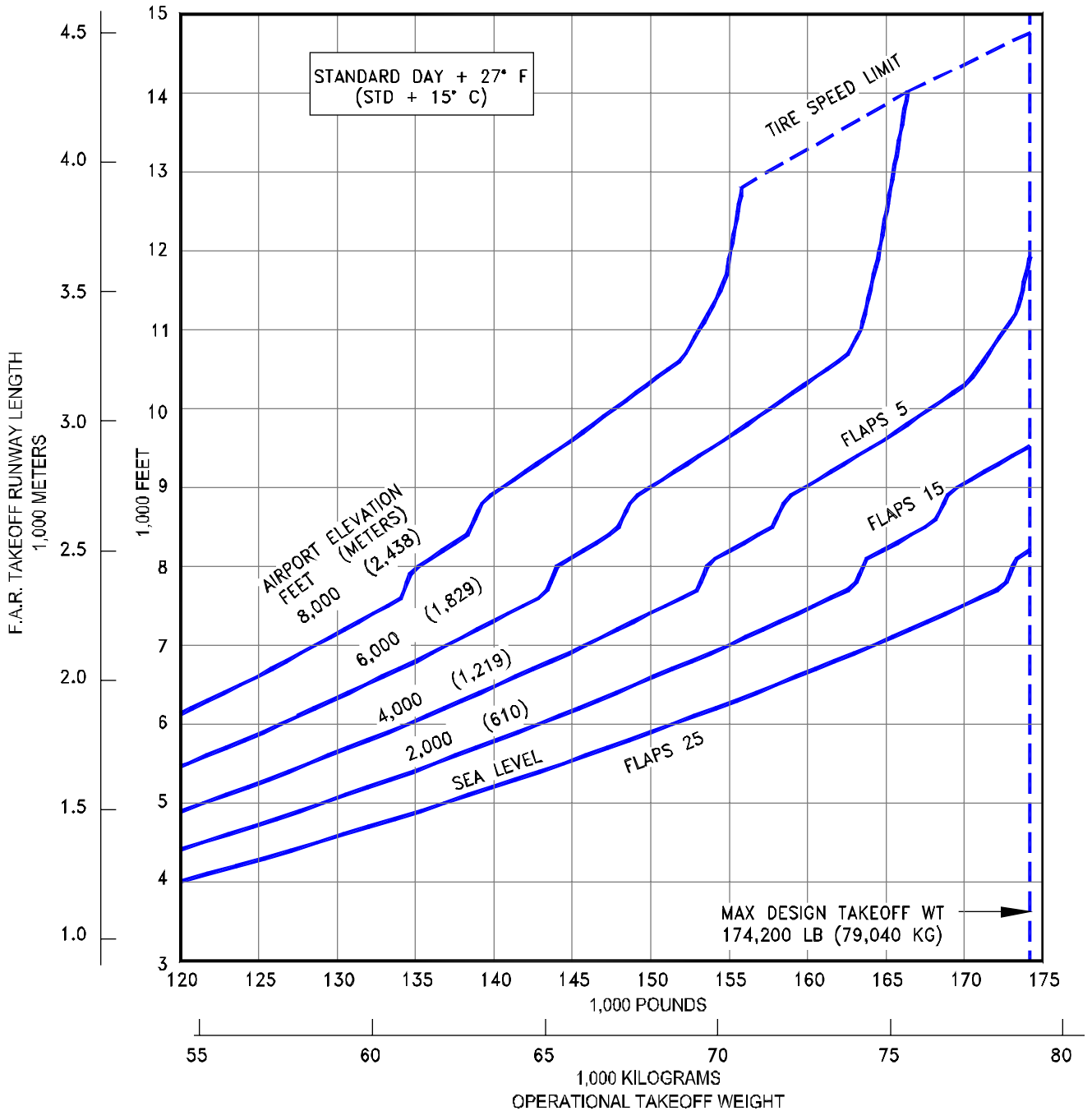

3.3.128 F.A.R. TAKEOFF RUNWAY LENGTH REQUIREMENTS

STANDARD DAY +27°F (STD + 15°C), DRY RUNWAY
MODEL 737-900 (CFM56-7B27 ENGINES AT 27,300 LB SLST)

NOTES:

- CFM56-7B27 ENGINES RATED AT 27,300 LB SLST
- NO ENGINE AIR BLEED FOR AIR CONDITIONING
- ZERO WIND, ZERO RUNWAY GRADIENT
- WET SMOOTH RUNWAY SURFACE
- CONSULT WITH USING AIRLINE FOR SPECIFIC OPERATING PROCEDURE PRIOR TO FACILITY DESIGN
- TAKEOFF PERFORMANCE IMPROVEMENTS ARE POSSIBLE USING GROOVED RUNWAY

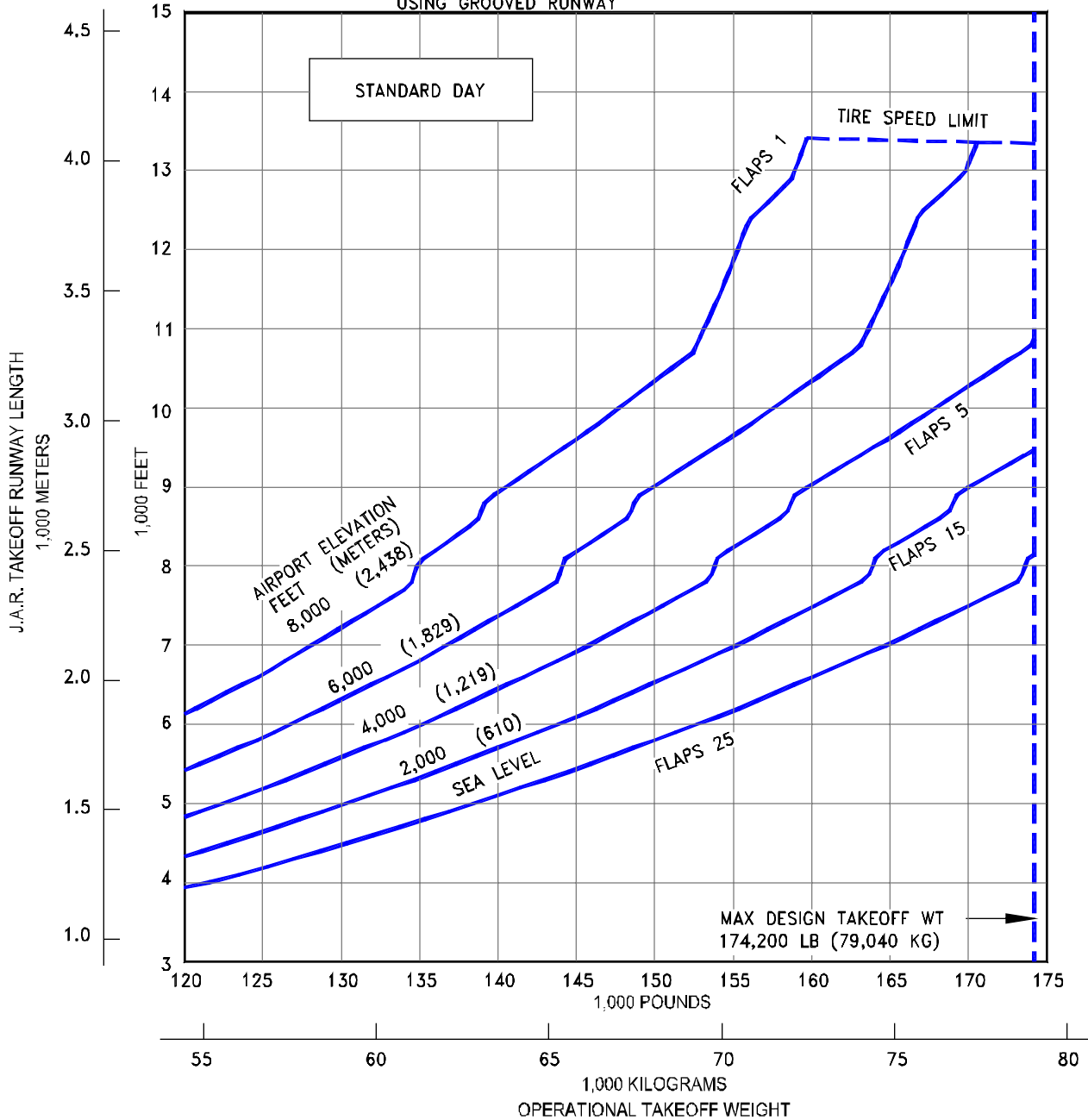

3.3.129 J.A.R. TAKEOFF RUNWAY LENGTH REQUIREMENTS
STANDARD DAY, WET RUNWAY
MODEL 737-900 (CFM56-7B27 ENGINES AT 27,300 LB SLST)

NOTES:

- CFM56-7B27 ENGINES RATED AT 27,300 LB SLST
- NO ENGINE AIR BLEED FOR AIR CONDITIONING
- ZERO WIND, ZERO RUNWAY GRADIENT
- WET SMOOTH RUNWAY SURFACE
- CONSULT WITH USING AIRLINE FOR SPECIFIC OPERATING PROCEDURE PRIOR TO FACILITY DESIGN
- TAKEOFF PERFORMANCE IMPROVEMENTS ARE POSSIBLE USING GROOVED RUNWAY

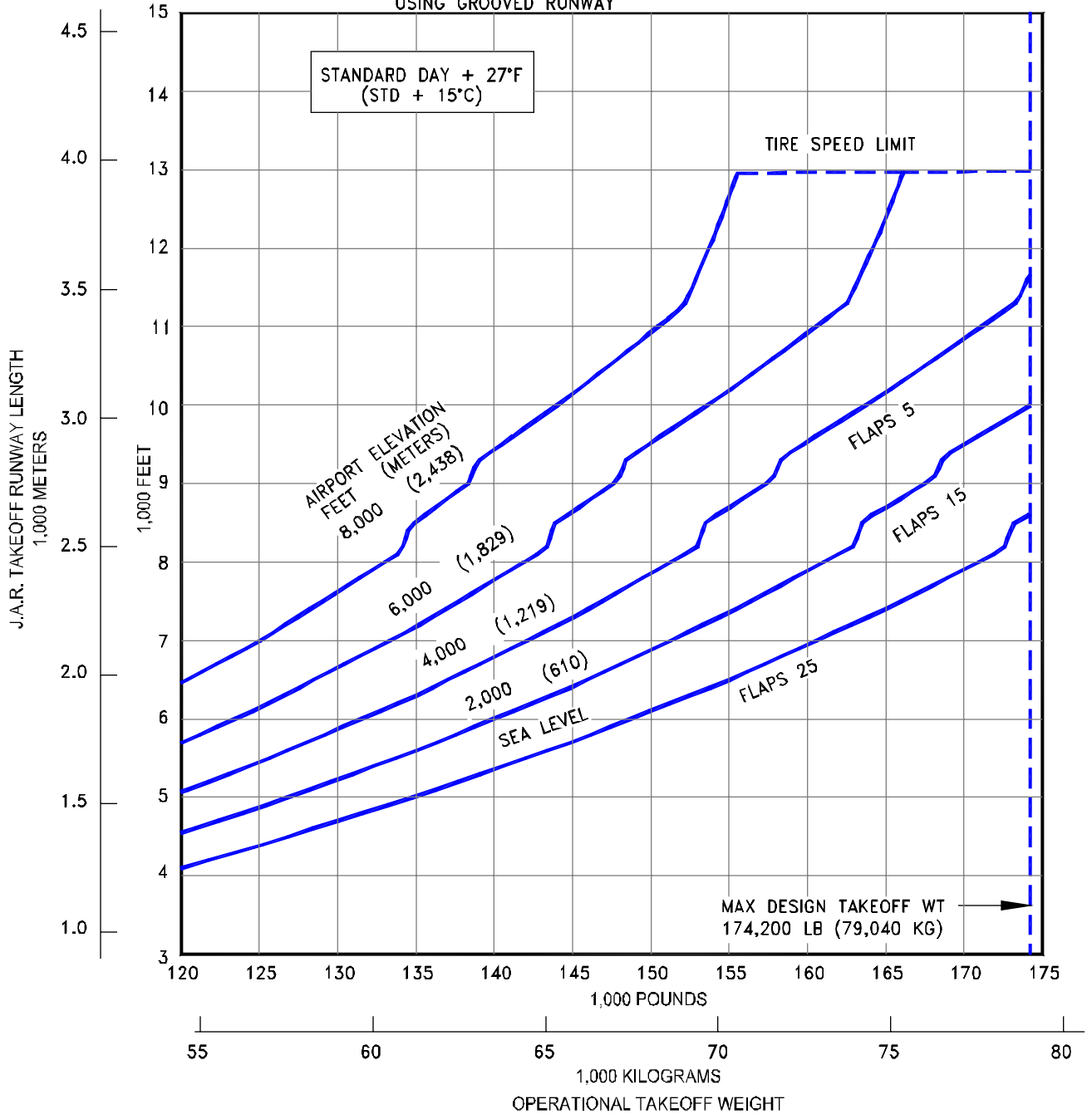

3.3.130 J.A.R. TAKEOFF RUNWAY LENGTH REQUIREMENTS

STANDARD DAY +27°F (STD + 15°C), WET RUNWAY

MODEL 737-900 (CFM56-7B27 ENGINES AT 27,300 LB SLST)

NOTES:

- CFM56-7B27 ENGINES RATED AT 27,300 LB SLST
- NO ENGINE AIR BLEED FOR AIR CONDITIONING
- ZERO WIND, ZERO RUNWAY GRADIENT
- DRY RUNWAY SURFACE
- CONSULT WITH USING AIRLINE FOR SPECIFIC OPERATING PROCEDURE PRIOR TO FACILITY DESIGN

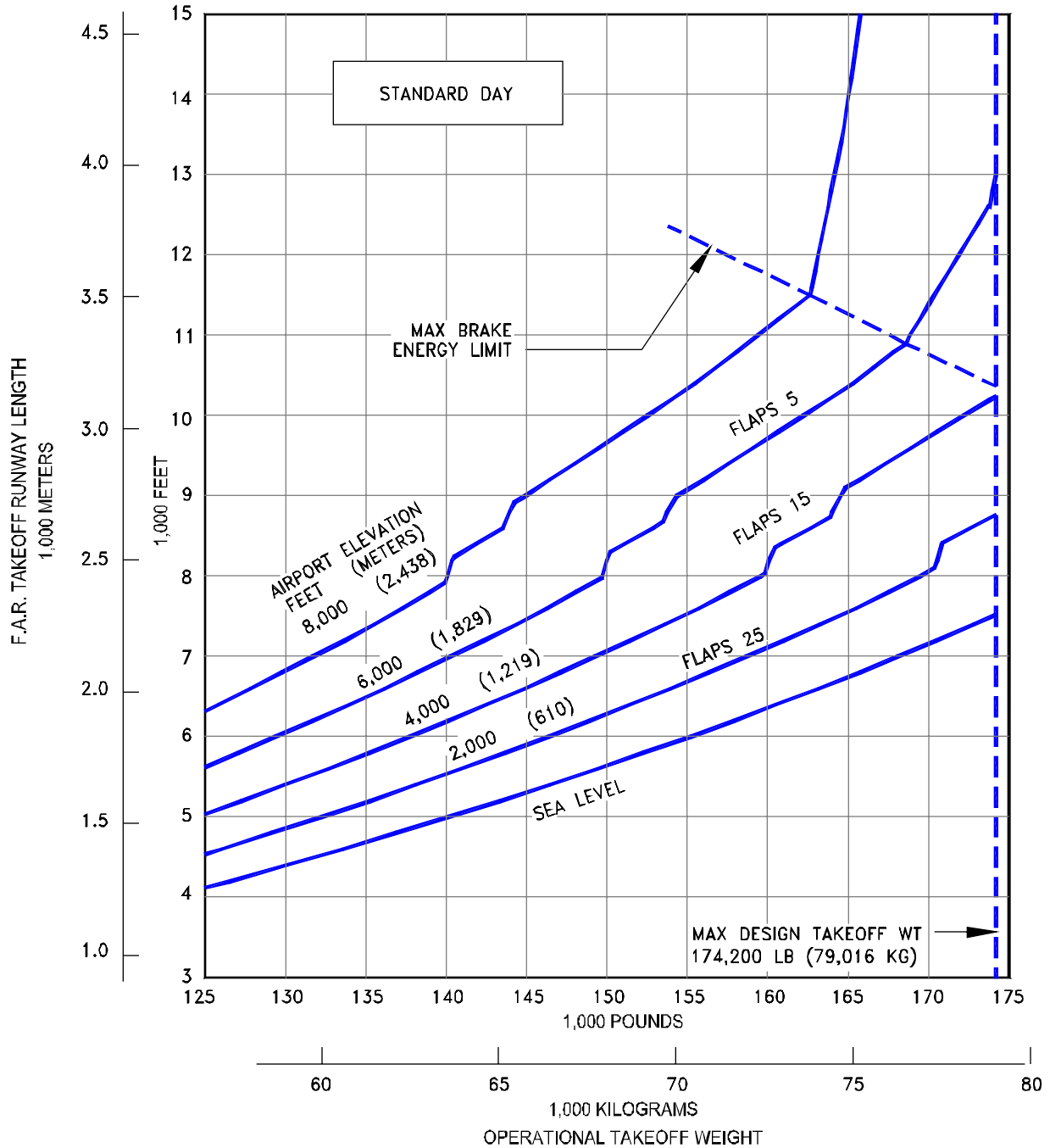

3.3.131 F.A.R. TAKEOFF RUNWAY LENGTH REQUIREMENTS

STANDARD DAY, DRY RUNWAY

MODEL 737-900 WITH WINGLETS (CFM56-7B27 ENGINES AT 27,300 LB SLST)

D6-58325-6

NOTES:

- CFM56-7B27 ENGINES RATED AT 27,300 LB SLST
- NO ENGINE AIR BLEED FOR AIR CONDITIONING
- ZERO WIND, ZERO RUNWAY GRADIENT
- DRY RUNWAY SURFACE
- CONSULT WITH USING AIRLINE FOR SPECIFIC OPERATING PROCEDURE PRIOR TO FACILITY DESIGN

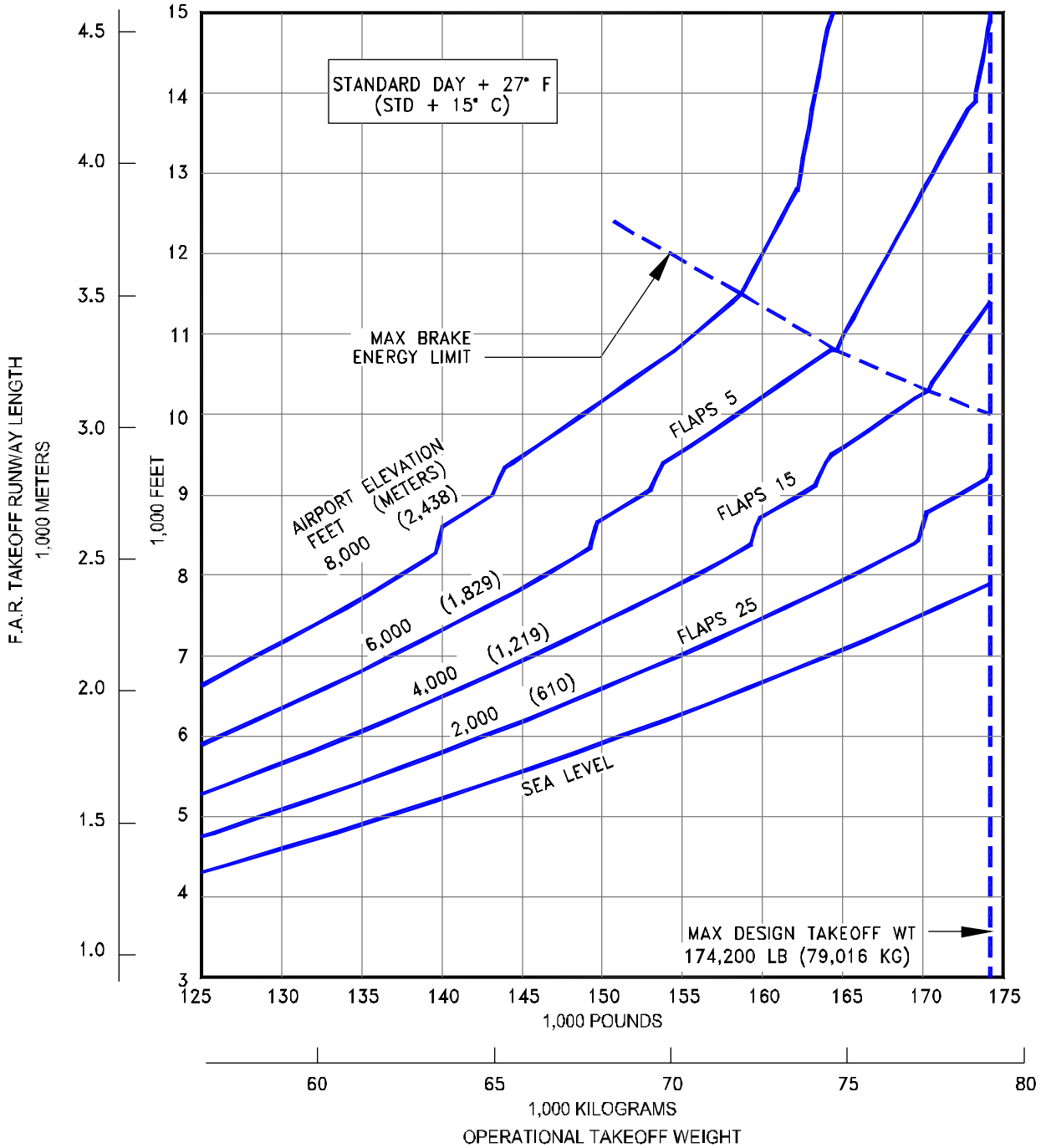

3.3.132 F.A.R. TAKEOFF RUNWAY LENGTH REQUIREMENTS

STANDARD DAY +27°F (STD + 15°C), DRY RUNWAY

MODEL 737-900 WITH WINGLETS (CFM56-7B27 ENGINES AT 27,300 LB SLST)

NOTES:

- CFM56-7B27 ENGINES RATED AT 27,300 LB SLST
- NO ENGINE AIR BLEED FOR AIR CONDITIONING
- ZERO WIND, ZERO RUNWAY GRADIENT
- WET SMOOTH RUNWAY SURFACE
- CONSULT WITH USING AIRLINE FOR SPECIFIC OPERATING PROCEDURE PRIOR TO FACILITY DESIGN
- TAKEOFF PERFORMANCE IMPROVEMENTS ARE POSSIBLE USING GROOVED RUNWAY

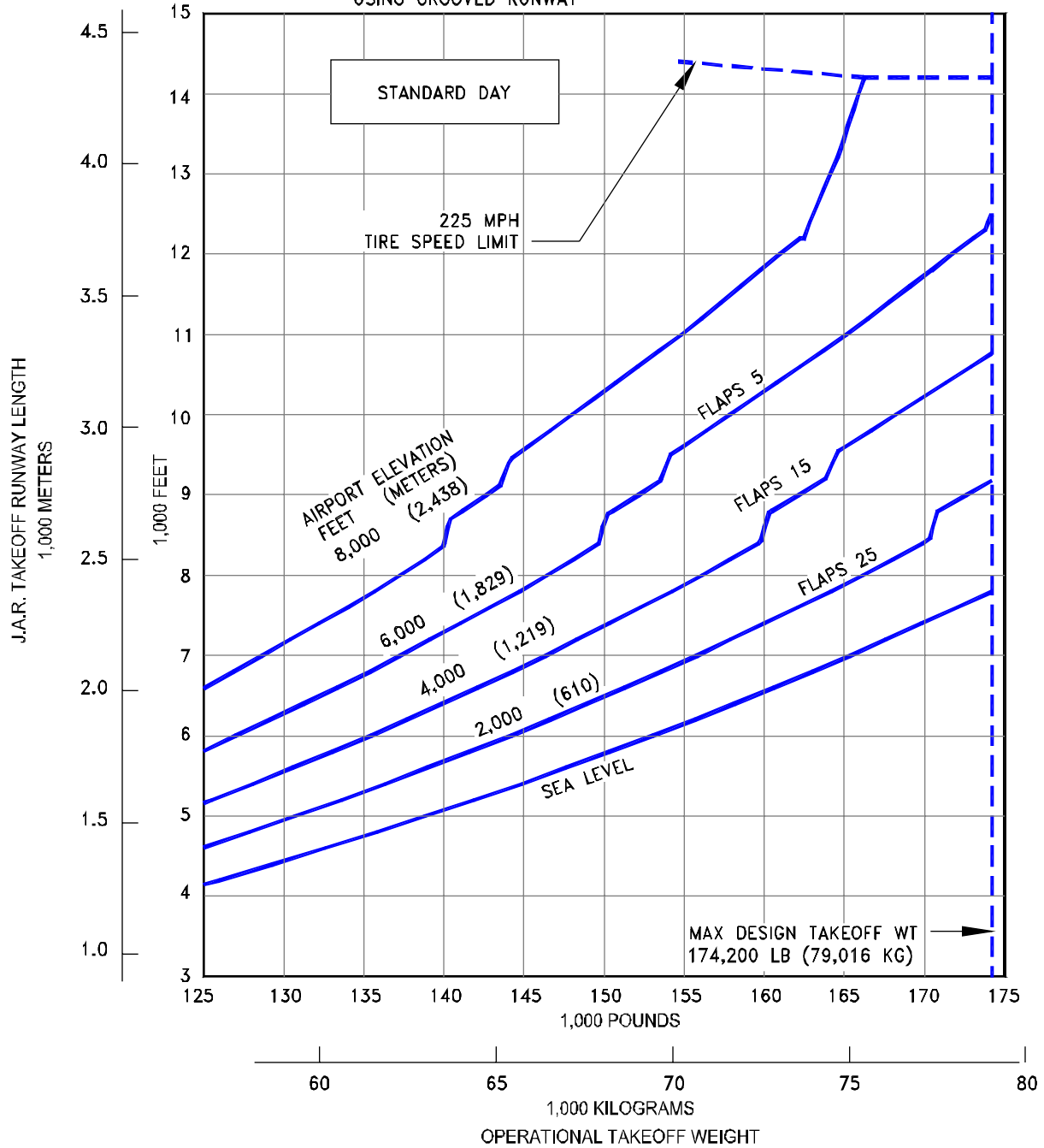

3.3.133 J.A.R. TAKEOFF RUNWAY LENGTH REQUIREMENTS
STANDARD DAY, WET RUNWAY
 MODEL 737-900 (CFM56-7B27 ENGINES AT 27,300 LB SLST)

D6-58325-6

NOTES:

- CFM56-7B27 ENGINES RATED AT 27,300 LB SLST
- NO ENGINE AIR BLEED FOR AIR CONDITIONING
- ZERO WIND, ZERO RUNWAY GRADIENT
- WET SMOOTH RUNWAY SURFACE
- CONSULT WITH USING AIRLINE FOR SPECIFIC OPERATING PROCEDURE PRIOR TO FACILITY DESIGN
- TAKEOFF PERFORMANCE IMPROVEMENTS ARE POSSIBLE USING GROOVED RUNWAY

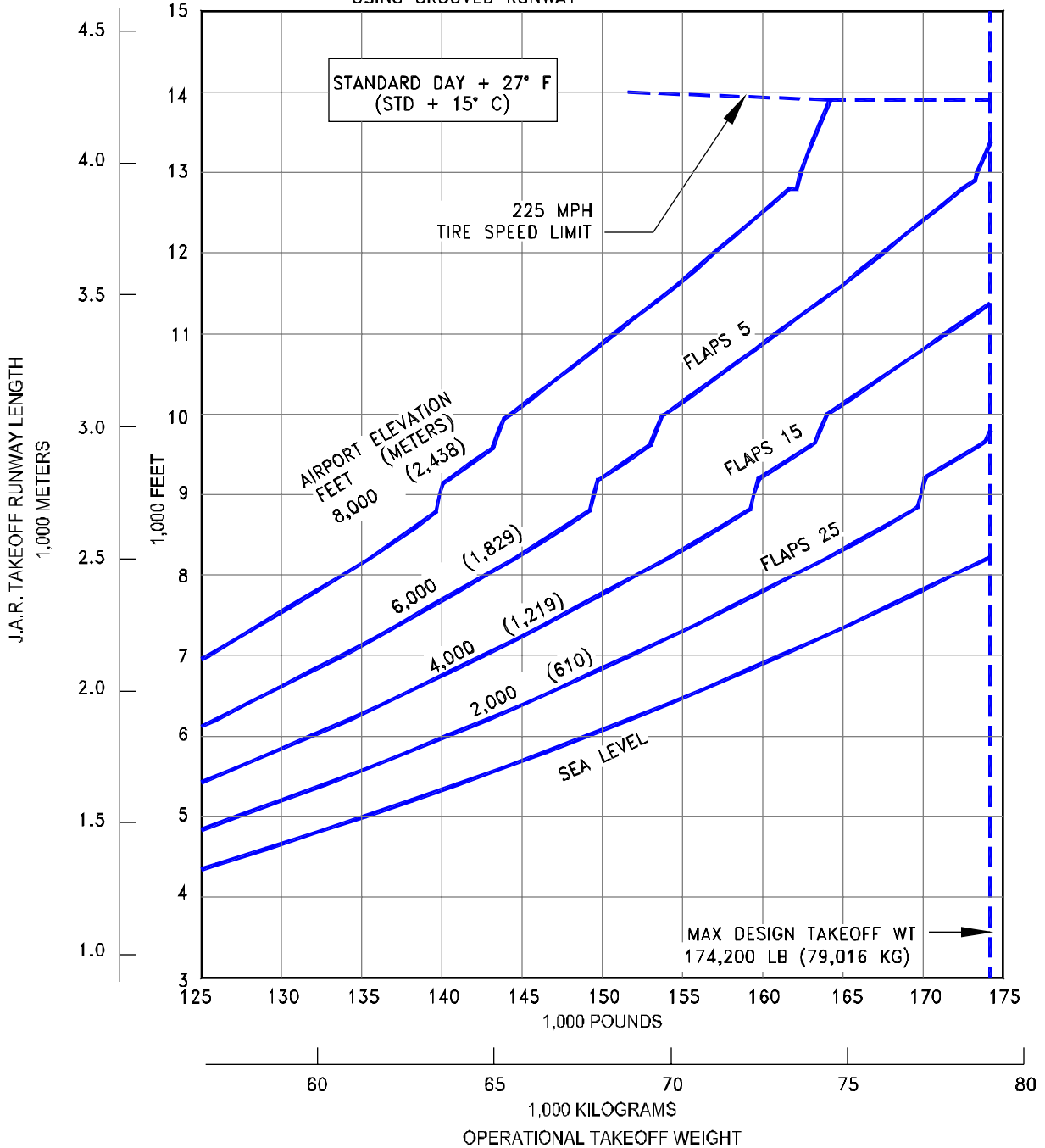

3.3.134 J.A.R. TAKEOFF RUNWAY LENGTH REQUIREMENTS
STANDARD DAY +27°F (STD + 15°C), WET RUNWAY
MODEL 737-900 (CFM56-7B27 ENGINES AT 27,300 LB SLST)

NOTES:

- CFM56-7B-27B1 ENGINES RATED AT 27,300 LB SLST
- NO ENGINE AIR BLEED FOR AIR CONDITIONING
- ZERO WIND, ZERO RUNWAY GRADIENT
- DRY RUNWAY SURFACE
- CONSULT WITH USING AIRLINE FOR SPECIFIC OPERATING PROCEDURE PRIOR TO FACILITY DESIGN

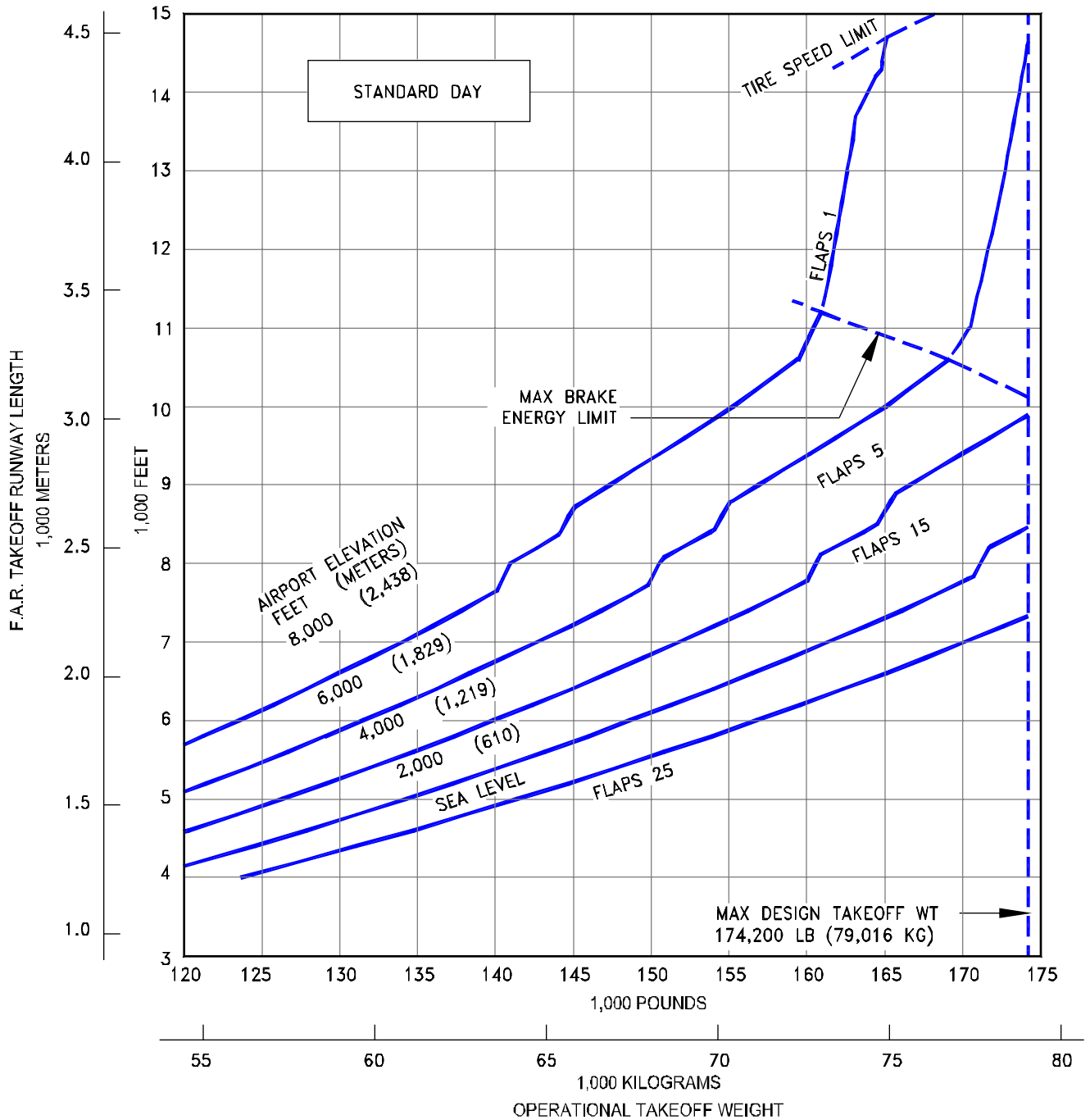

3.3.135 F.A.R. TAKEOFF RUNWAY LENGTH REQUIREMENTS
STANDARD DAY, DRY RUNWAY
MODEL 737-900 (CFM56-7B27B1 ENGINES AT 27,300 LB SLST)

D6-58325-6

NOTES:

- CFM56-7B-27B1 ENGINES RATED AT 27,300 LB SLST
- NO ENGINE AIR BLEED FOR AIR CONDITIONING
- ZERO WIND, ZERO RUNWAY GRADIENT
- DRY RUNWAY SURFACE
- CONSULT WITH USING AIRLINE FOR SPECIFIC OPERATING PROCEDURE PRIOR TO FACILITY DESIGN

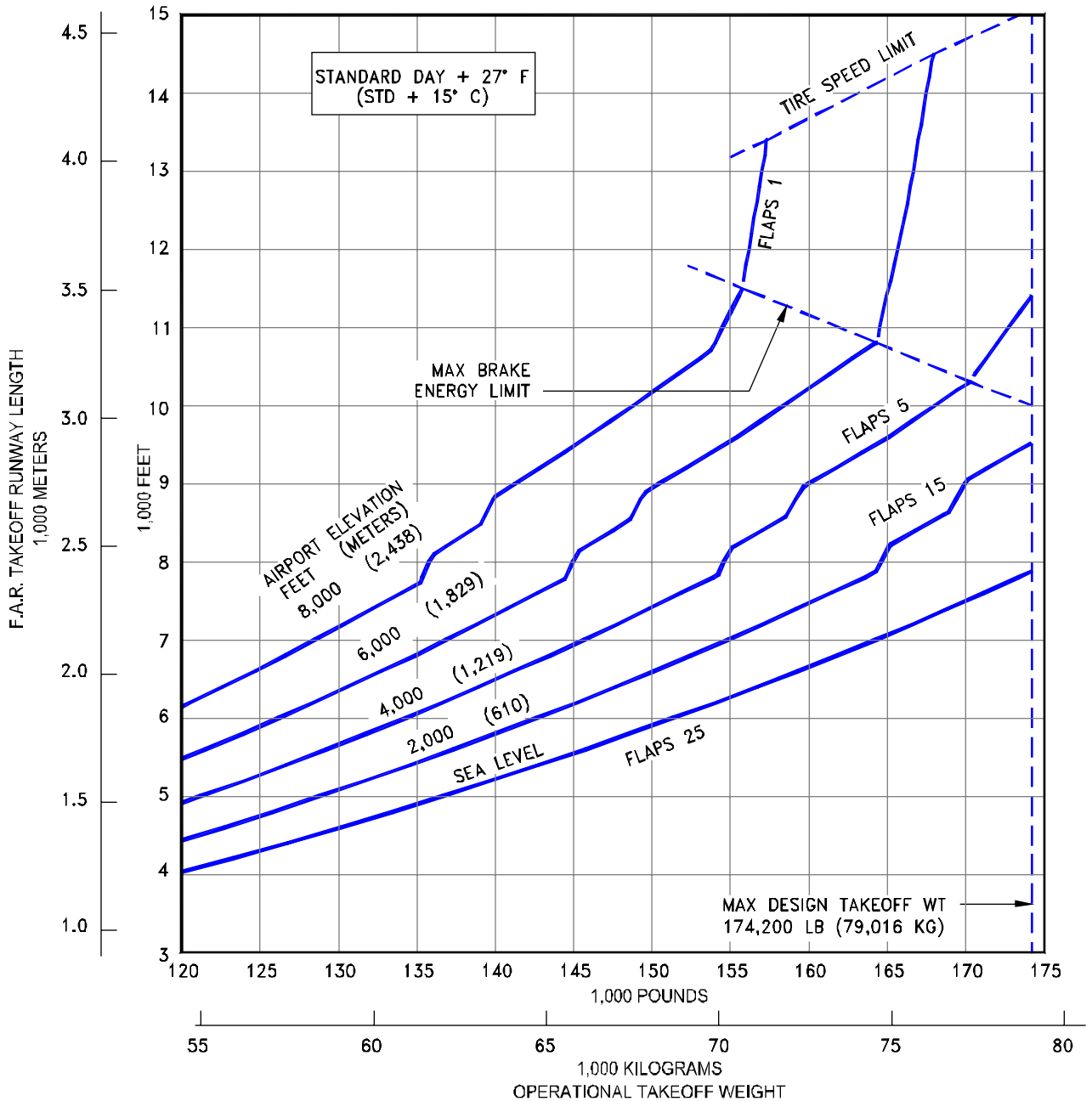

3.3.136 F.A.R. TAKEOFF RUNWAY LENGTH REQUIREMENTS

STANDARD DAY +27°F (STD + 15°C), DRY RUNWAY

MODEL 737-900 (CFM56-7B27B1 ENGINES AT 27,300 LB SLST)

NOTES:

- CFM56-7B-27B1 ENGINES RATED AT 27,300 LB SLST
- NO ENGINE AIR BLEED FOR AIR CONDITIONING
- ZERO WIND, ZERO RUNWAY GRADIENT
- WET SMOOTH RUNWAY SURFACE
- CONSULT WITH USING AIRLINE FOR SPECIFIC OPERATING PROCEDURE PRIOR TO FACILITY DESIGN
- TAKEOFF PERFORMANCE IMPROVEMENTS ARE POSSIBLE USING GROOVED RUNWAY

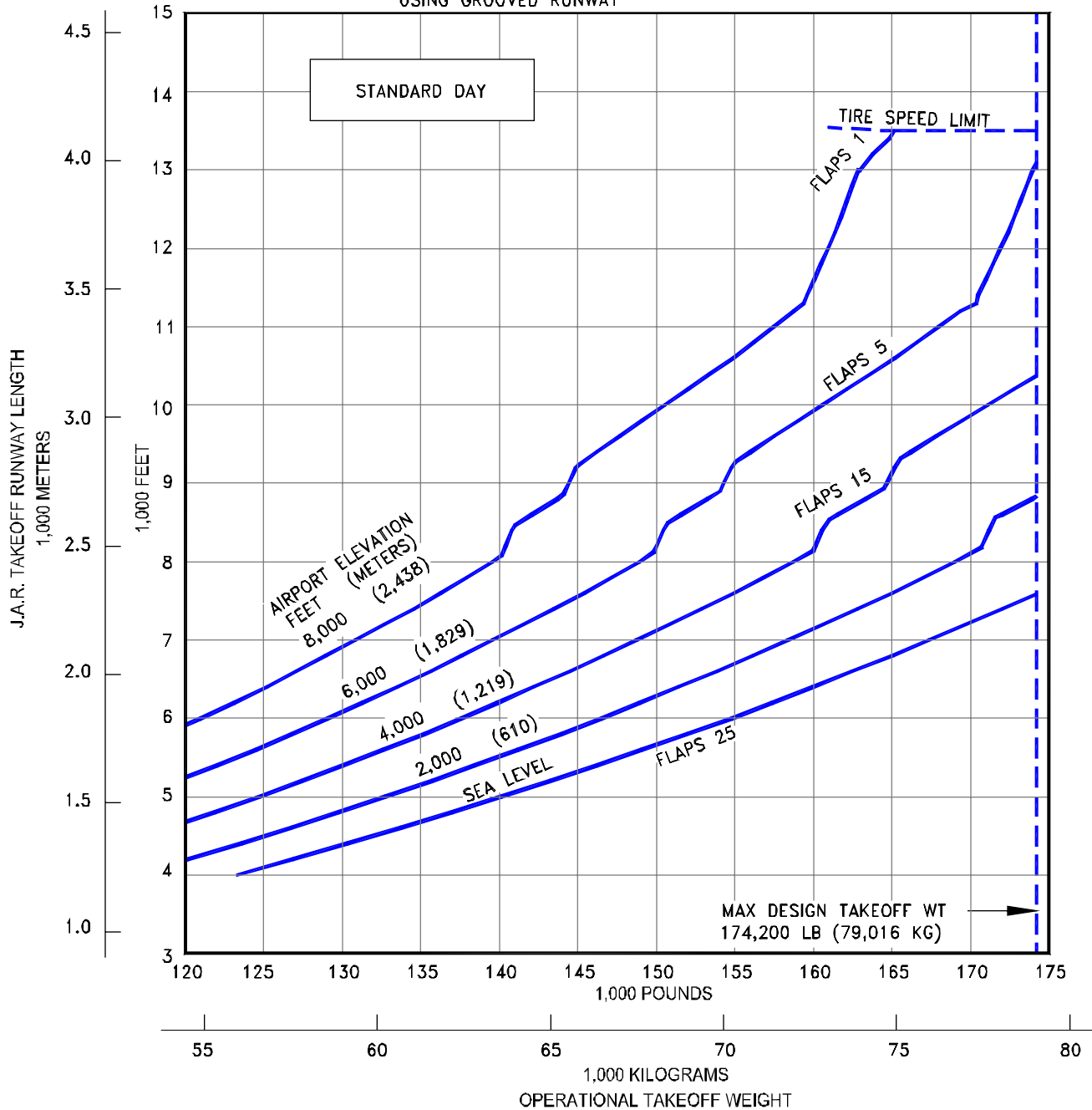

**3.3.137 J.A.R. TAKEOFF RUNWAY LENGTH REQUIREMENTS|
STANDARD DAY, WET RUNWAY**
MODEL 737-900 (CFM56-7B27B1 ENGINES AT 27,300 LB SLST)

D6-58325-6

NOTES:

- CFM56-7B-27B1 ENGINES RATED AT 27,300 LB SLST
- NO ENGINE AIR BLEED FOR AIR CONDITIONING
- ZERO WIND, ZERO RUNWAY GRADIENT
- WET SMOOTH RUNWAY SURFACE
- CONSULT WITH USING AIRLINE FOR SPECIFIC OPERATING PROCEDURE PRIOR TO FACILITY DESIGN
- ◆ TAKEOFF PERFORMANCE IMPROVEMENTS ARE POSSIBLE USING GROOVED RUNWAY

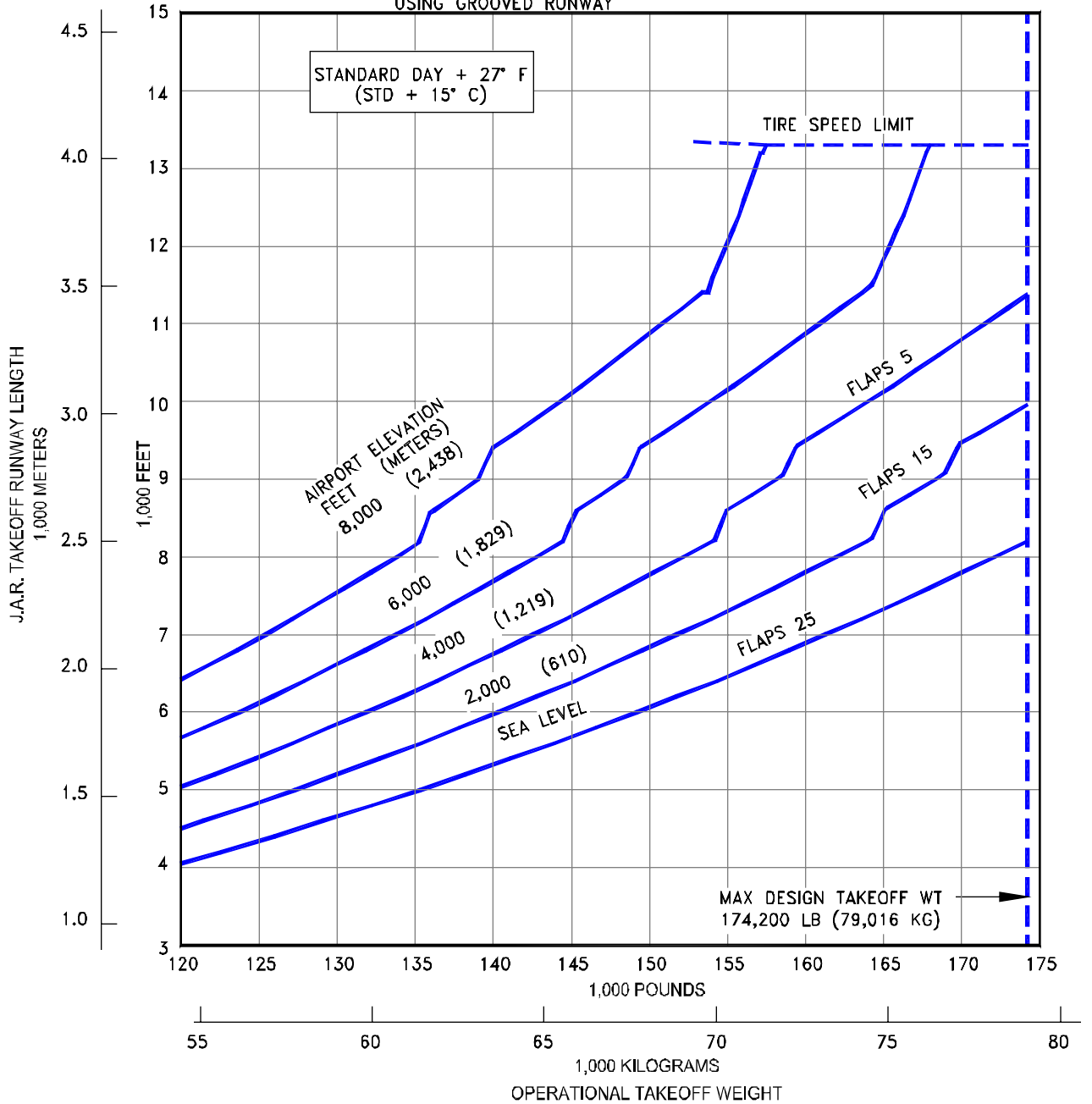

3.3.138 J.A.R. TAKEOFF RUNWAY LENGTH REQUIREMENTS
STANDARD DAY +27°F (STD + 15°C), WET RUNWAY
MODEL 737-900 (CFM56-7B27B1 ENGINES AT 27,300 LB SLST)

NOTES:

- CFM56-7B27B1 ENGINES RATED AT 27,300 LB SLST
- NO ENGINE AIR BLEED FOR AIR CONDITIONING
- ZERO WIND, ZERO RUNWAY GRADIENT
- DRY RUNWAY SURFACE
- CONSULT WITH USING AIRLINE FOR SPECIFIC OPERATING PROCEDURE PRIOR TO FACILITY DESIGN

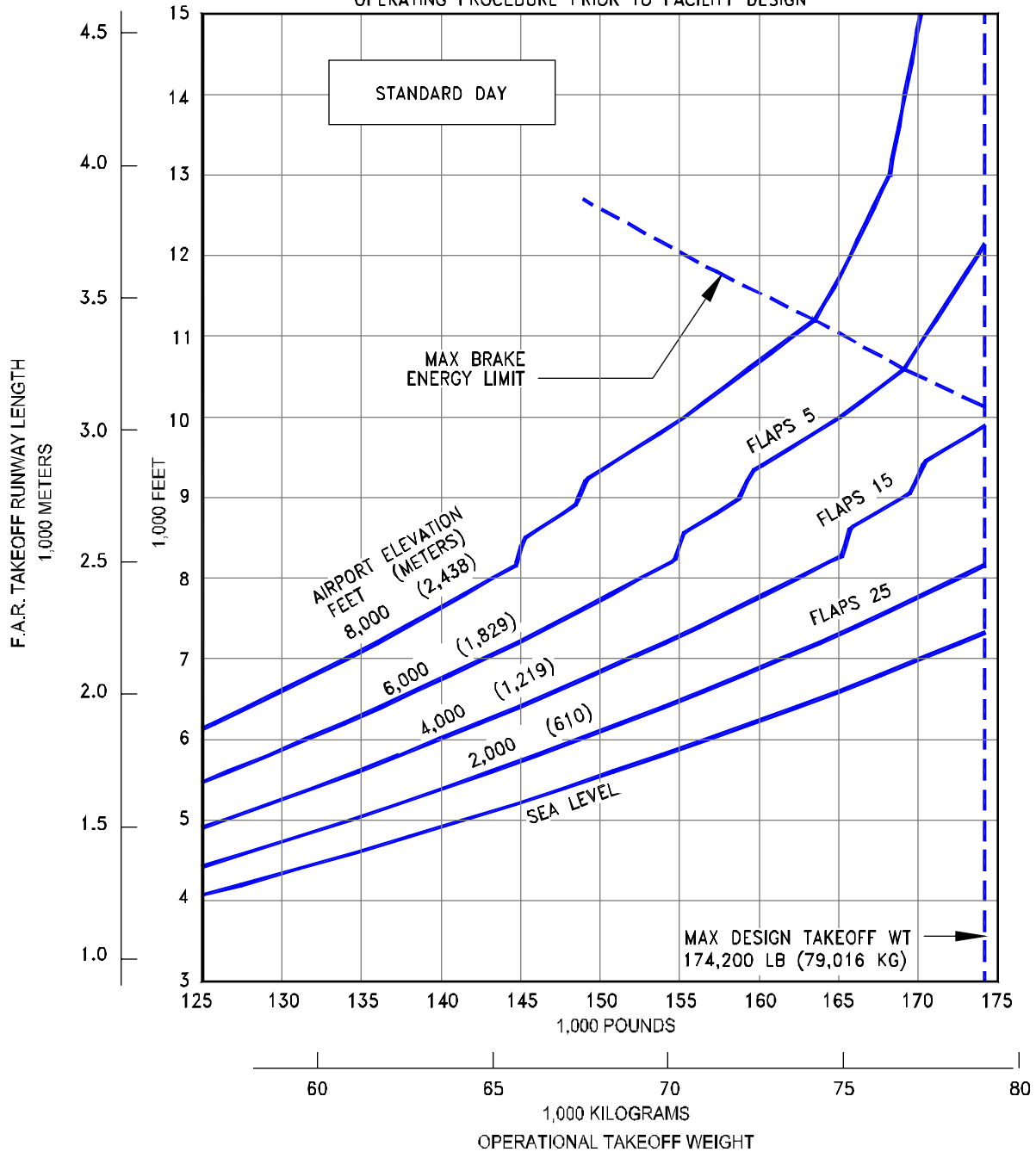

3.3.139 F.A.R. TAKEOFF RUNWAY LENGTH REQUIREMENTS
STANDARD DAY, DRY RUNWAY
MODEL 737-900 (CFM56-7B27B1 ENGINES AT 27,300 LB SLST)

NOTES:

- CFM56-7B27B1 ENGINES RATED AT 27,300 LB SLST
- NO ENGINE AIR BLEED FOR AIR CONDITIONING
- ZERO WIND, ZERO RUNWAY GRADIENT
- DRY RUNWAY SURFACE
- CONSULT WITH USING AIRLINE FOR SPECIFIC OPERATING PROCEDURE PRIOR TO FACILITY DESIGN

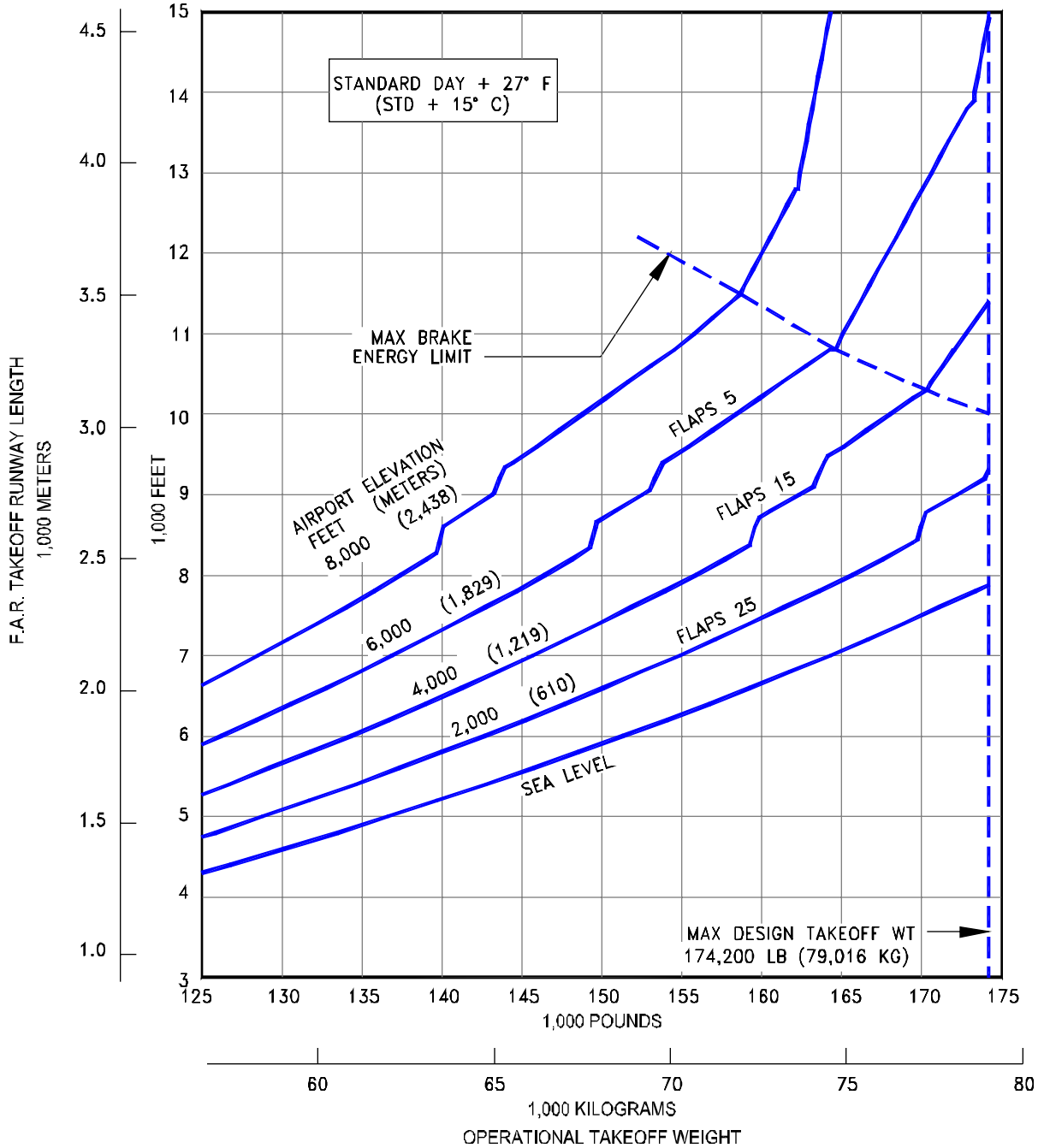

3.3.140 F.A.R. TAKEOFF RUNWAY LENGTH REQUIREMENTS
STANDARD DAY +27°F (STD + 15°C), DRY RUNWAY
MODEL 737-900 (CFM56-7B27B1 ENGINES AT 27,300 LB SLST)

NOTES:

- CFM56-7B27B1 ENGINES RATED AT 27,300 LB SLST
- NO ENGINE AIR BLEED FOR AIR CONDITIONING
- ZERO WIND, ZERO RUNWAY GRADIENT
- WET SMOOTH RUNWAY SURFACE
- CONSULT WITH USING AIRLINE FOR SPECIFIC OPERATING PROCEDURE PRIOR TO FACILITY DESIGN
- TAKEOFF PERFORMANCE IMPROVEMENTS ARE POSSIBLE USING GROOVED RUNWAY

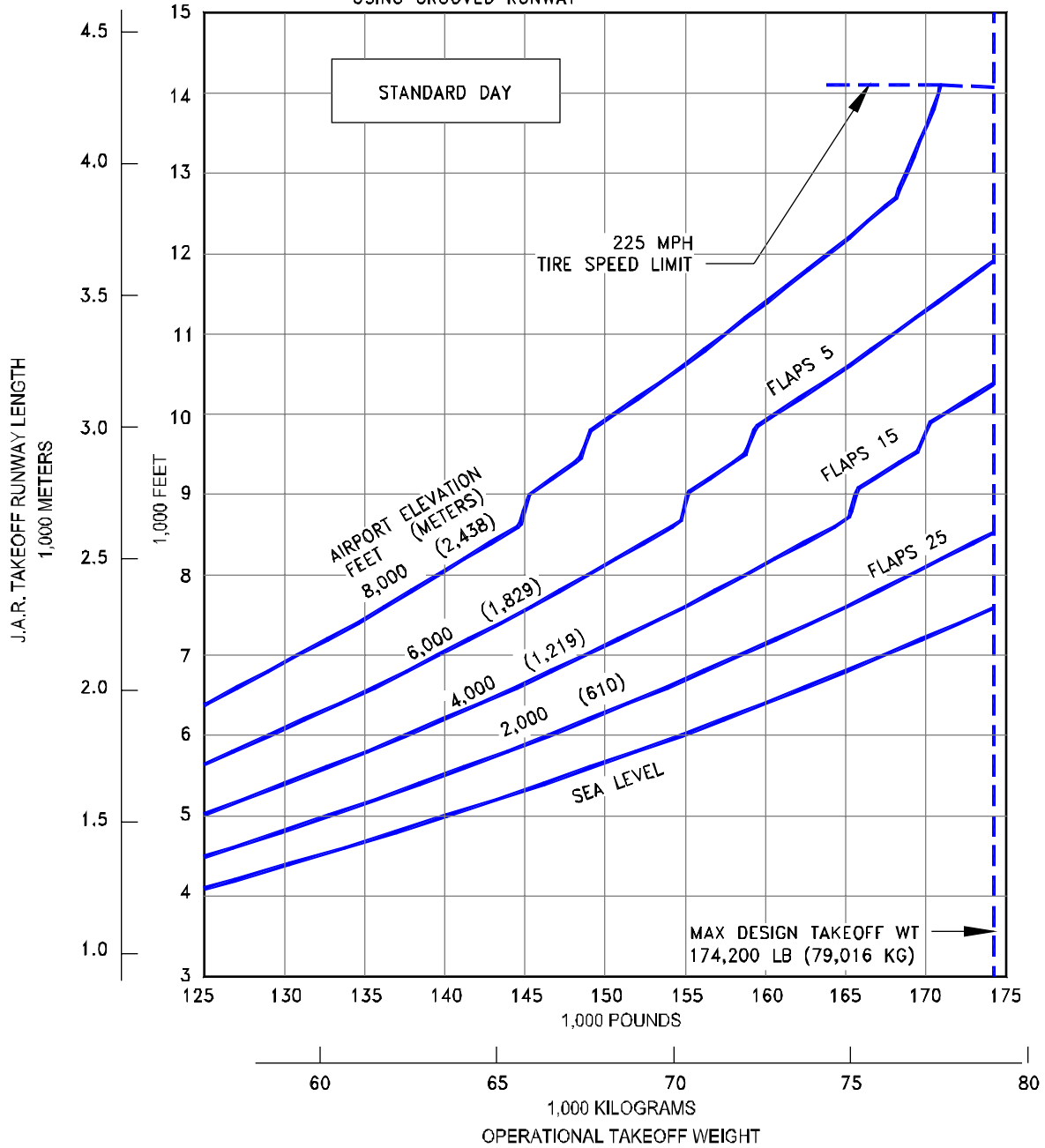

**3.3.141 J.A.R. TAKEOFF RUNWAY LENGTH REQUIREMENTS
STANDARD DAY, WET RUNWAY**
MODEL 737-900 (CFM56-7B27B1 ENGINES AT 27,300 LB SLST)

NOTES:

- CFM56-7B27B1 ENGINES RATED AT 27,300 LB SLST
- ◆ NO ENGINE AIR BLEED FOR AIR CONDITIONING
- ZERO WIND, ZERO RUNWAY GRADIENT
- WET SMOOTH RUNWAY SURFACE
- ◆ CONSULT WITH USING AIRLINE FOR SPECIFIC OPERATING PROCEDURE PRIOR TO FACILITY DESIGN
- TAKEOFF PERFORMANCE IMPROVEMENTS ARE POSSIBLE USING GROOVED RUNWAY

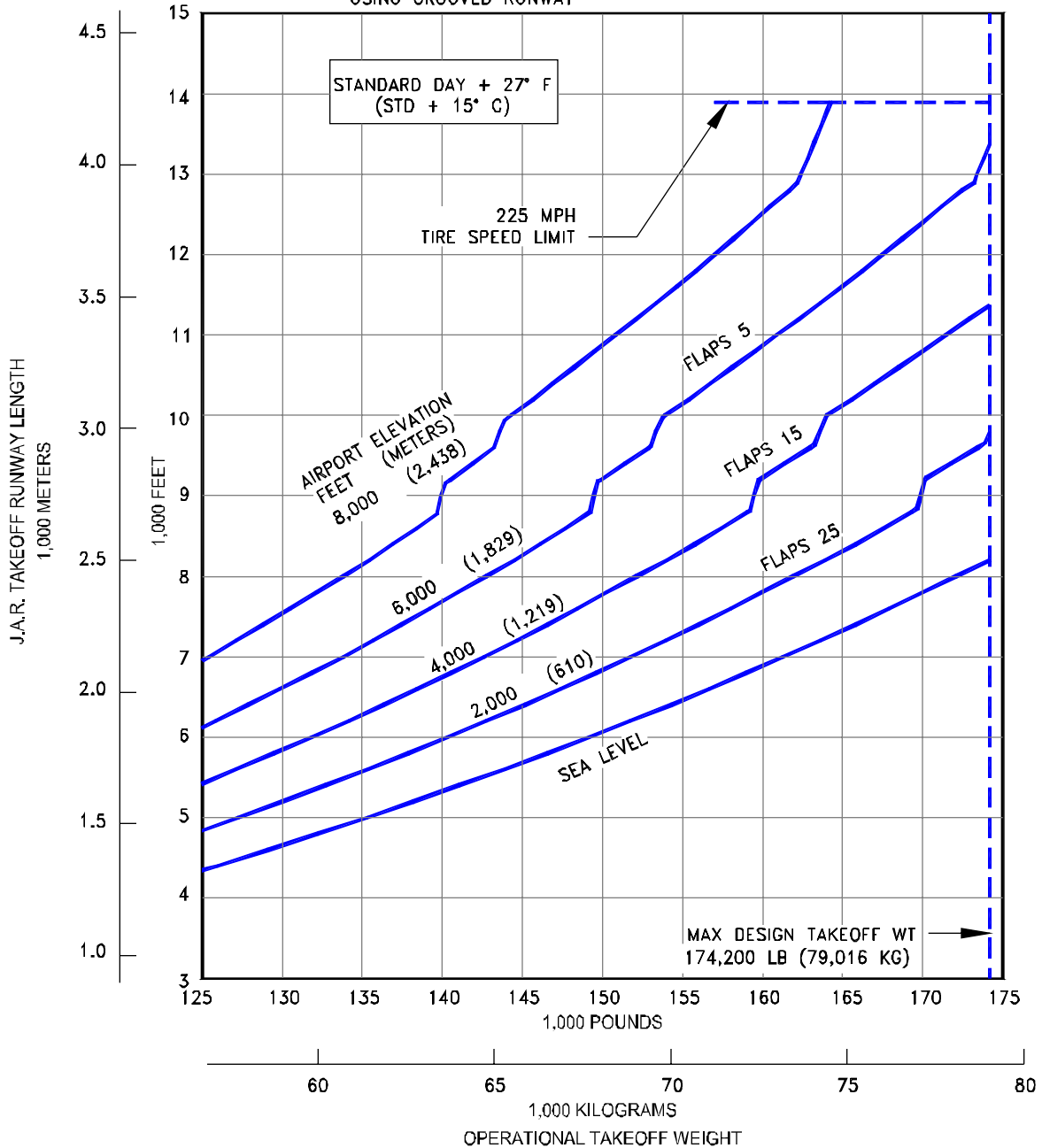

3.3.142 J.A.R. TAKEOFF RUNWAY LENGTH REQUIREMENTS

STANDARD DAY +27°F (STD + 15°C), WET RUNWAY
MODEL 737-900 (CFM56-7B27B1 ENGINES AT 27,300 LB SLST)

PRELIMINARY INFORMATION

NOTES:

- CFM56-7B26/3 ENGINES RATED AT 26,300 LB SLST
- NO ENGINE AIR BLEED FOR AIR CONDITIONING
- ZERO WIND, ZERO RUNWAY GRADIENT
- DRY RUNWAY SURFACE
- CONSULT WITH USING AIRLINE FOR SPECIFIC OPERATING PROCEDURE PRIOR TO FACILITY DESIGN

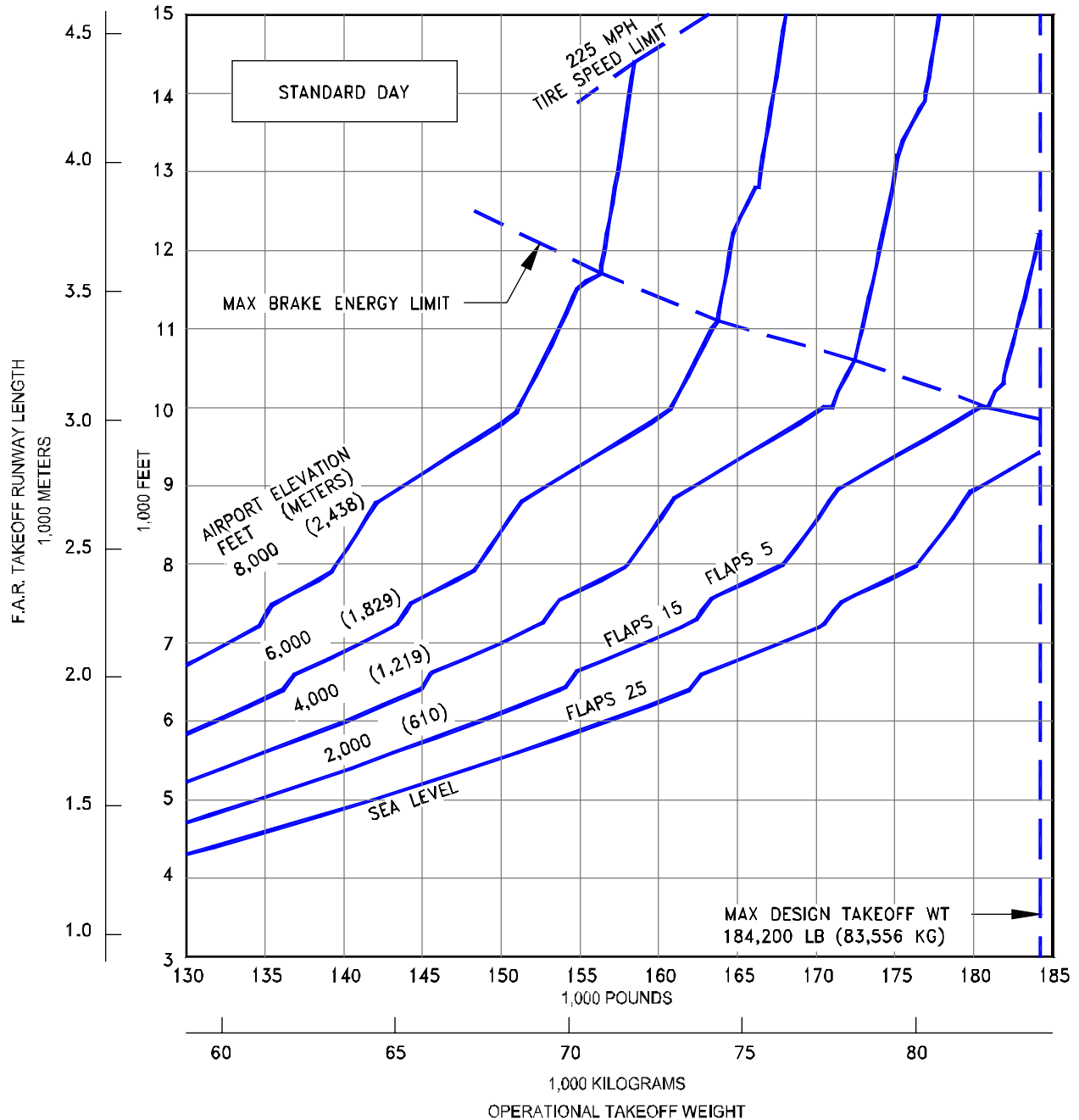

3.3.143 F.A.R. TAKEOFF RUNWAY LENGTH REQUIREMENTS
STANDARD DAY, DRY RUNWAY
MODEL 737-900ER (CFM56-7B26/3 ENGINES AT 26,300 LB SLST)

D6-58325-6

PRELIMINARY INFORMATION

NOTES:

- CFM56-7B26/3 ENGINES RATED AT 26,300 LB SLST
- NO ENGINE AIR BLEED FOR AIR CONDITIONING
- ZERO WIND, ZERO RUNWAY GRADIENT
- DRY RUNWAY SURFACE
- CONSULT WITH USING AIRLINE FOR SPECIFIC OPERATING PROCEDURE PRIOR TO FACILITY DESIGN

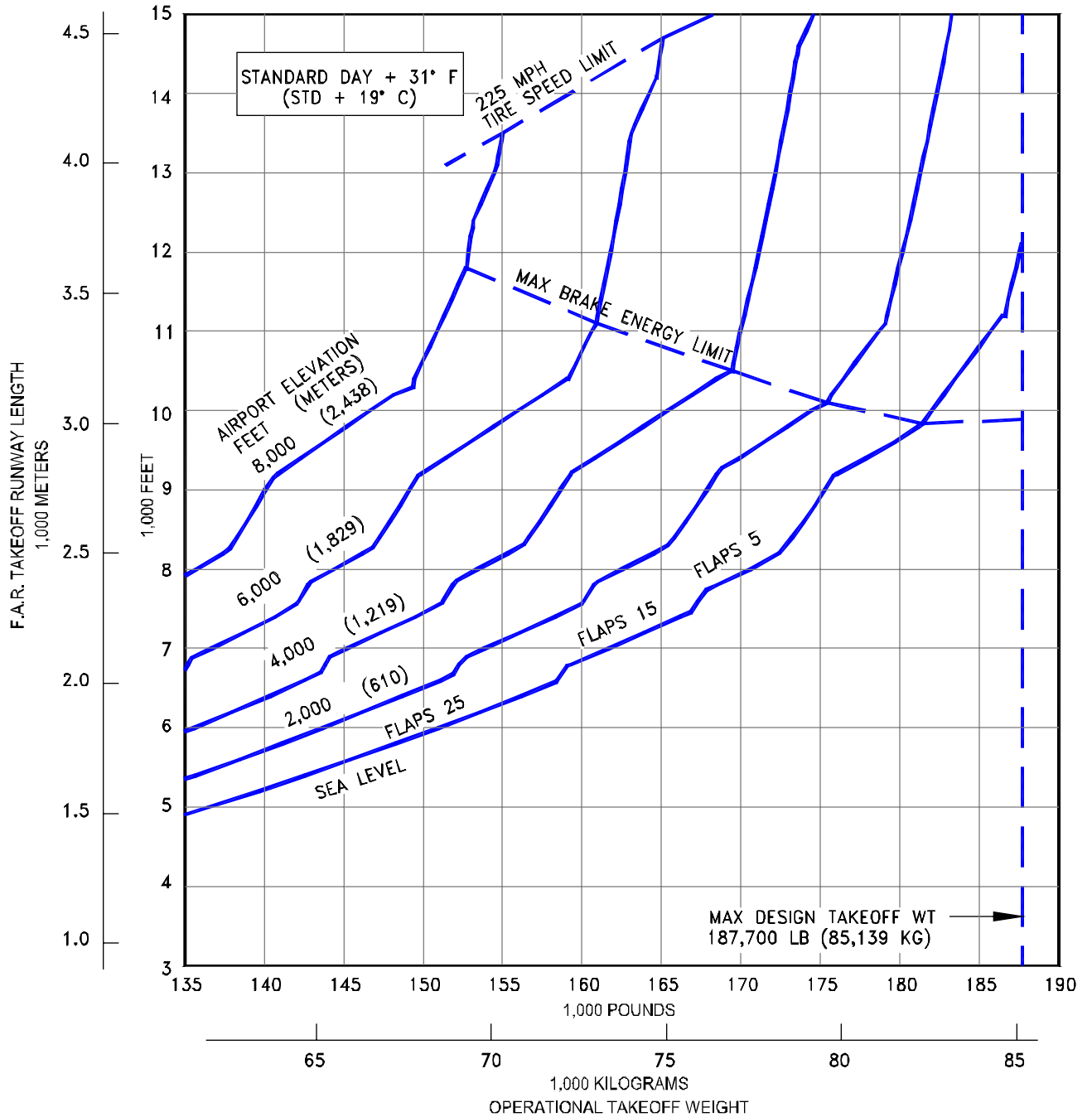

3.3.144 F.A.R. TAKEOFF RUNWAY LENGTH REQUIREMENTS

STANDARD DAY +31°F (STD + 19°C), DRY RUNWAY
 MODEL 737-900ER (CFM56-7B26/3 ENGINES AT 26,300 LB SLST)

PRELIMINARY INFORMATION

NOTES:

- CFM56-7B26/3 ENGINES RATED AT 26,300 LB SLST
- NO ENGINE AIR BLEED FOR AIR CONDITIONING
- ZERO WIND, ZERO RUNWAY GRADIENT
- WET SMOOTH RUNWAY SURFACE
- CONSULT WITH USING AIRLINE FOR SPECIFIC OPERATING PROCEDURE PRIOR TO FACILITY DESIGN
- TAKEOFF PERFORMANCE IMPROVEMENTS ARE POSSIBLE USING GROOVED RUNWAY

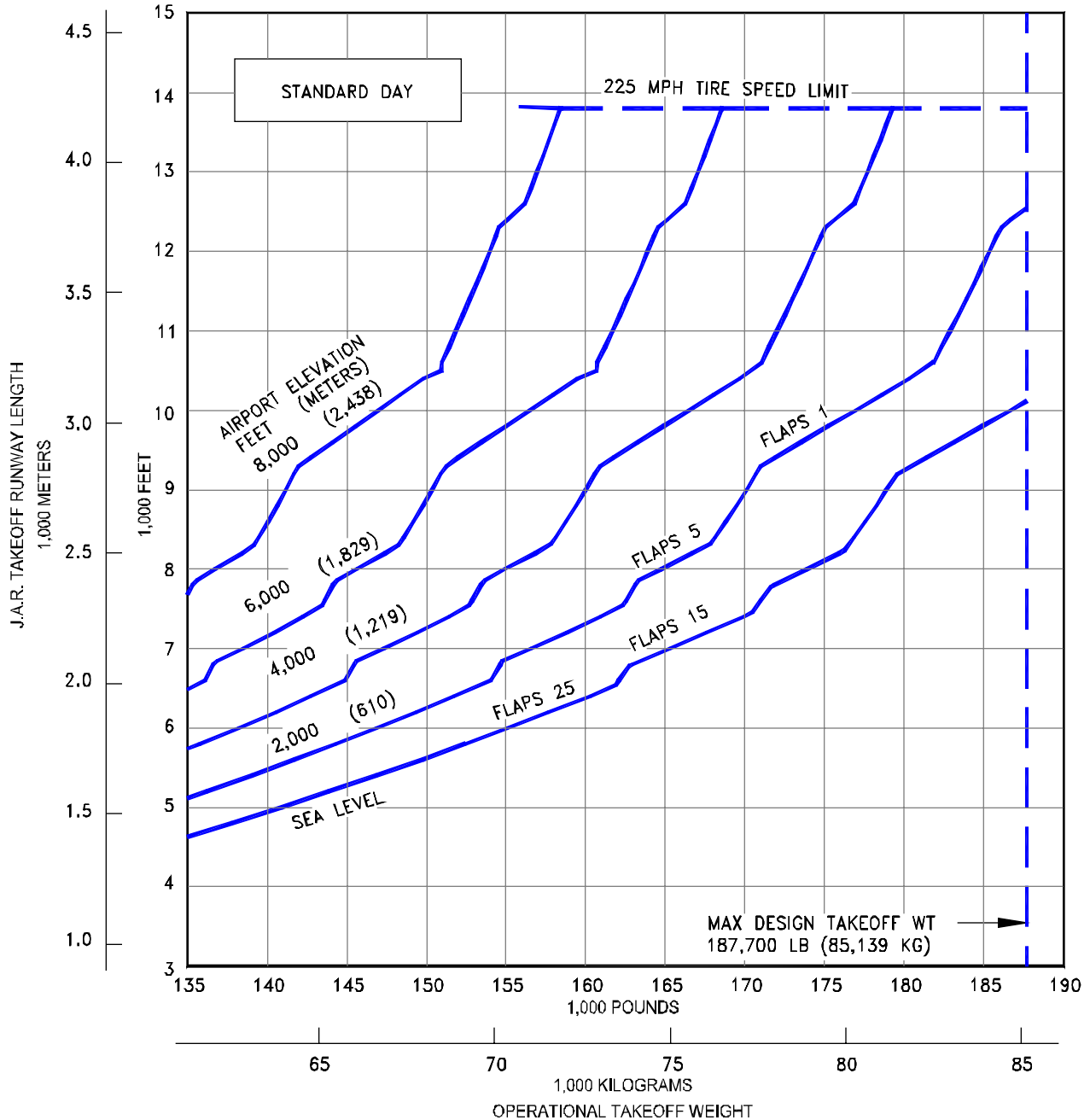

**3.3.145 J.A.R. TAKEOFF RUNWAY LENGTH REQUIREMENTS
STANDARD DAY, WET RUNWAY
MODEL 737-900ER (CFM56-7B26/3 ENGINES AT 26,300 LB SLST)**

PRELIMINARY INFORMATION

NOTES:

- CFM56-7B26/3 ENGINES RATED AT 26,300 LB SLST
- NO ENGINE AIR BLEED FOR AIR CONDITIONING
- ZERO WIND, ZERO RUNWAY GRADIENT
- WET SMOOTH RUNWAY SURFACE
- CONSULT WITH USING AIRLINE FOR SPECIFIC OPERATING PROCEDURE PRIOR TO FACILITY DESIGN
- TAKEOFF PERFORMANCE IMPROVEMENTS ARE POSSIBLE USING GROOVED RUNWAY

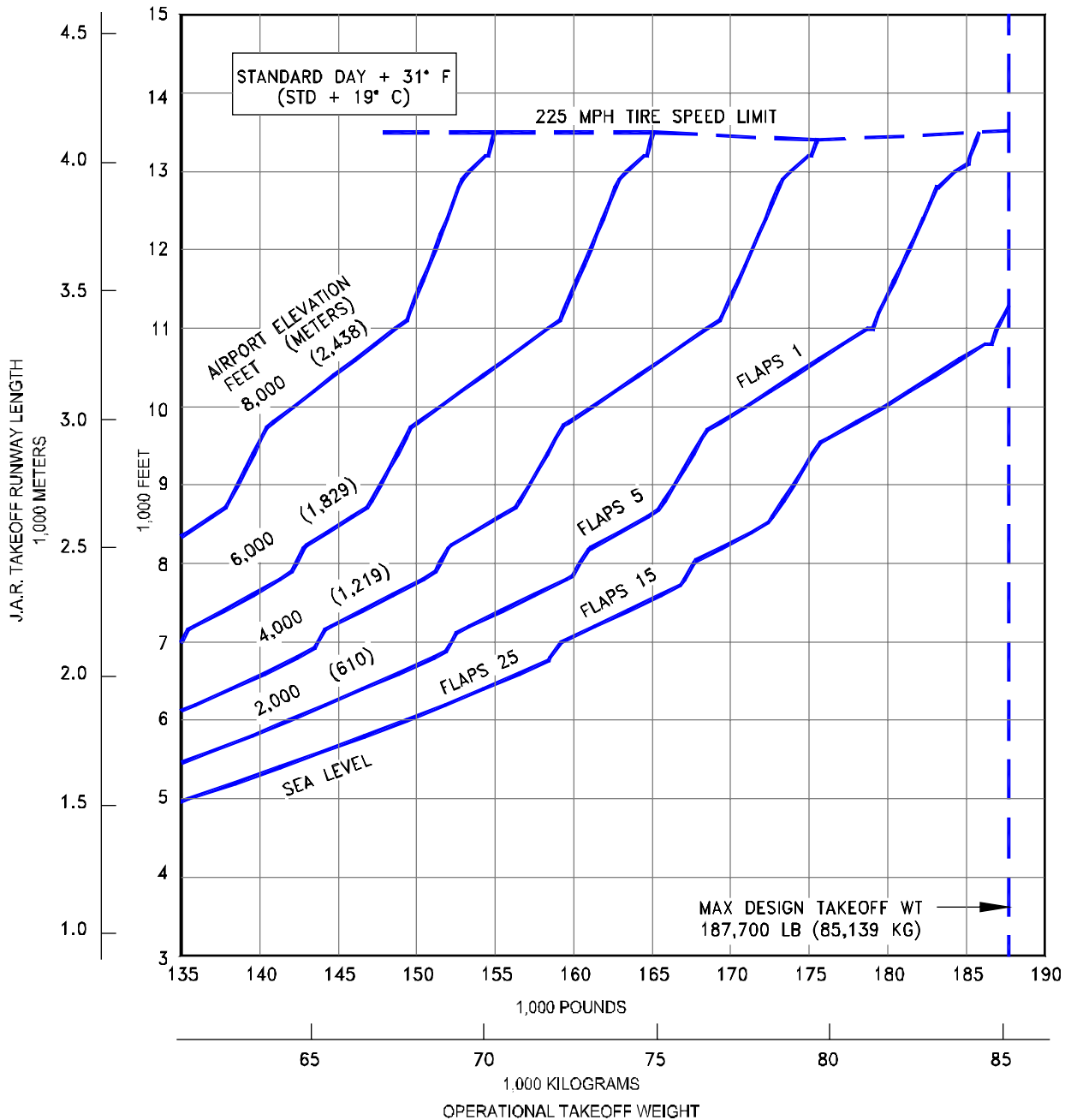

3.3.146 J.A.R. TAKEOFF RUNWAY LENGTH REQUIREMENTS

STANDARD DAY +31°F (STD + 19°C), WET RUNWAY

MODEL 737-900ER (CFM56-7B26/3 ENGINES AT 26,300 LB SLST)

PRELIMINARY INFORMATION

NOTES:

- CFM56-7B27/3F ENGINES RATED AT 27,300 LB SLST
- NO ENGINE AIR BLEED FOR AIR CONDITIONING
- ZERO WIND, ZERO RUNWAY GRADIENT
- DRY RUNWAY SURFACE
- CONSULT WITH USING AIRLINE FOR SPECIFIC OPERATING PROCEDURE PRIOR TO FACILITY DESIGN

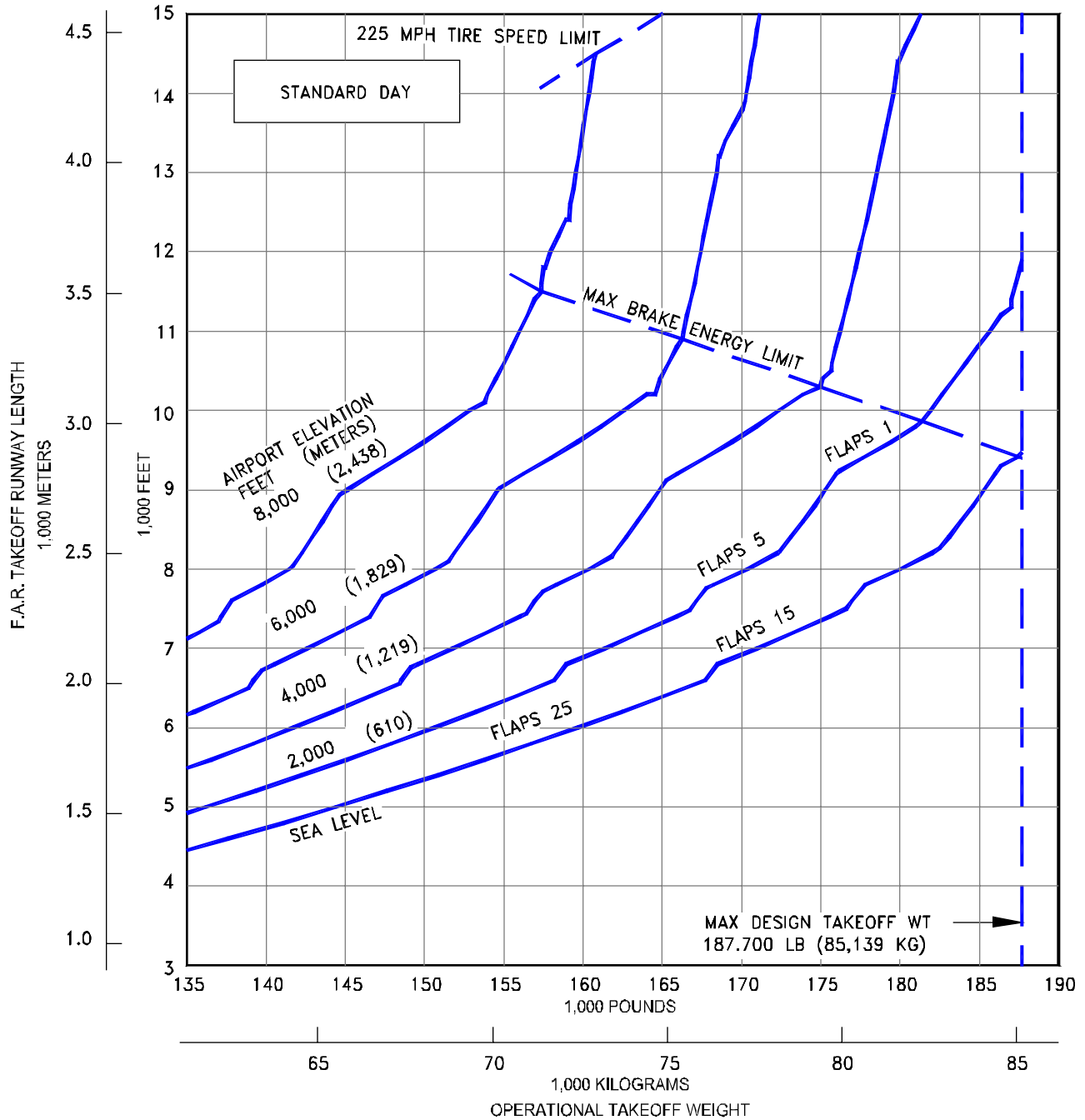

3.3.147 F.A.R. TAKEOFF RUNWAY LENGTH REQUIREMENTS
STANDARD DAY, DRY RUNWAY
MODEL 737-900ER (CFM56-7B27/3F ENGINES AT 27,300 LB SLST)

D6-58325-6

PRELIMINARY INFORMATION

NOTES:

- CFM56-7B27/3F ENGINES RATED AT 27,300 LB SLST
- NO ENGINE AIR BLEED FOR AIR CONDITIONING
- ZERO WIND, ZERO RUNWAY GRADIENT
- DRY RUNWAY SURFACE
- CONSULT WITH USING AIRLINE FOR SPECIFIC OPERATING PROCEDURE PRIOR TO FACILITY DESIGN

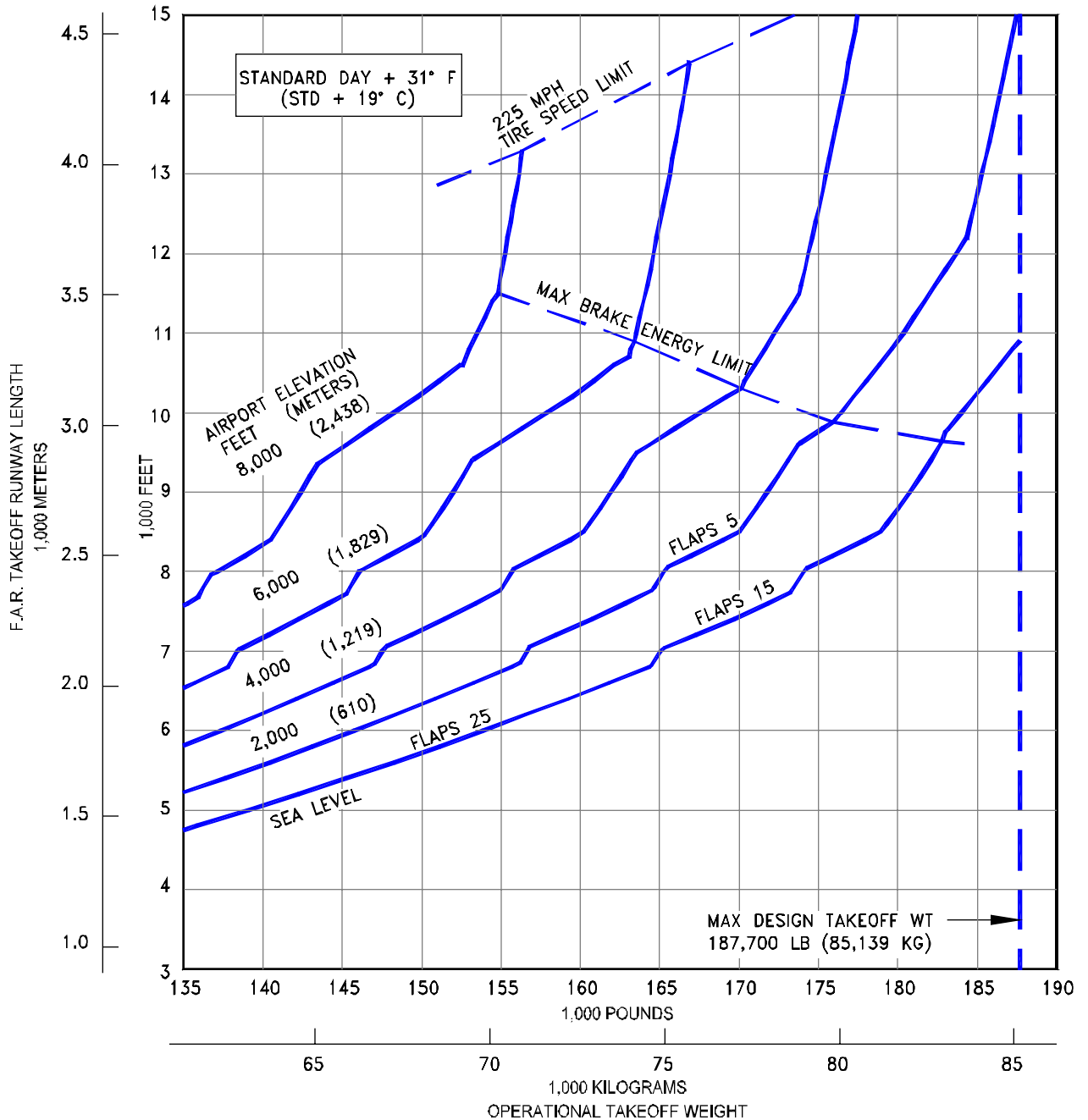

3.3.148 F.A.R. TAKEOFF RUNWAY LENGTH REQUIREMENTS
STANDARD DAY +31°F (STD + 19°C), DRY RUNWAY
MODEL 737-900ER (CFM56-7B27/3F ENGINES AT 27,300 LB SLST)

PRELIMINARY INFORMATION

NOTES:

- ◆ CFM56-7B27/3F ENGINES RATED AT 27,300 LB SLST
- ◆ NO ENGINE AIR BLEED FOR AIR CONDITIONING
- ◆ ZERO WIND, ZERO RUNWAY GRADIENT
- ◆ WET SMOOTH RUNWAY SURFACE
- ◆ CONSULT WITH USING AIRLINE FOR SPECIFIC OPERATING PROCEDURE PRIOR TO FACILITY DESIGN
- ◆ TAKEOFF PERFORMANCE IMPROVEMENTS ARE POSSIBLE USING GROOVED RUNWAY

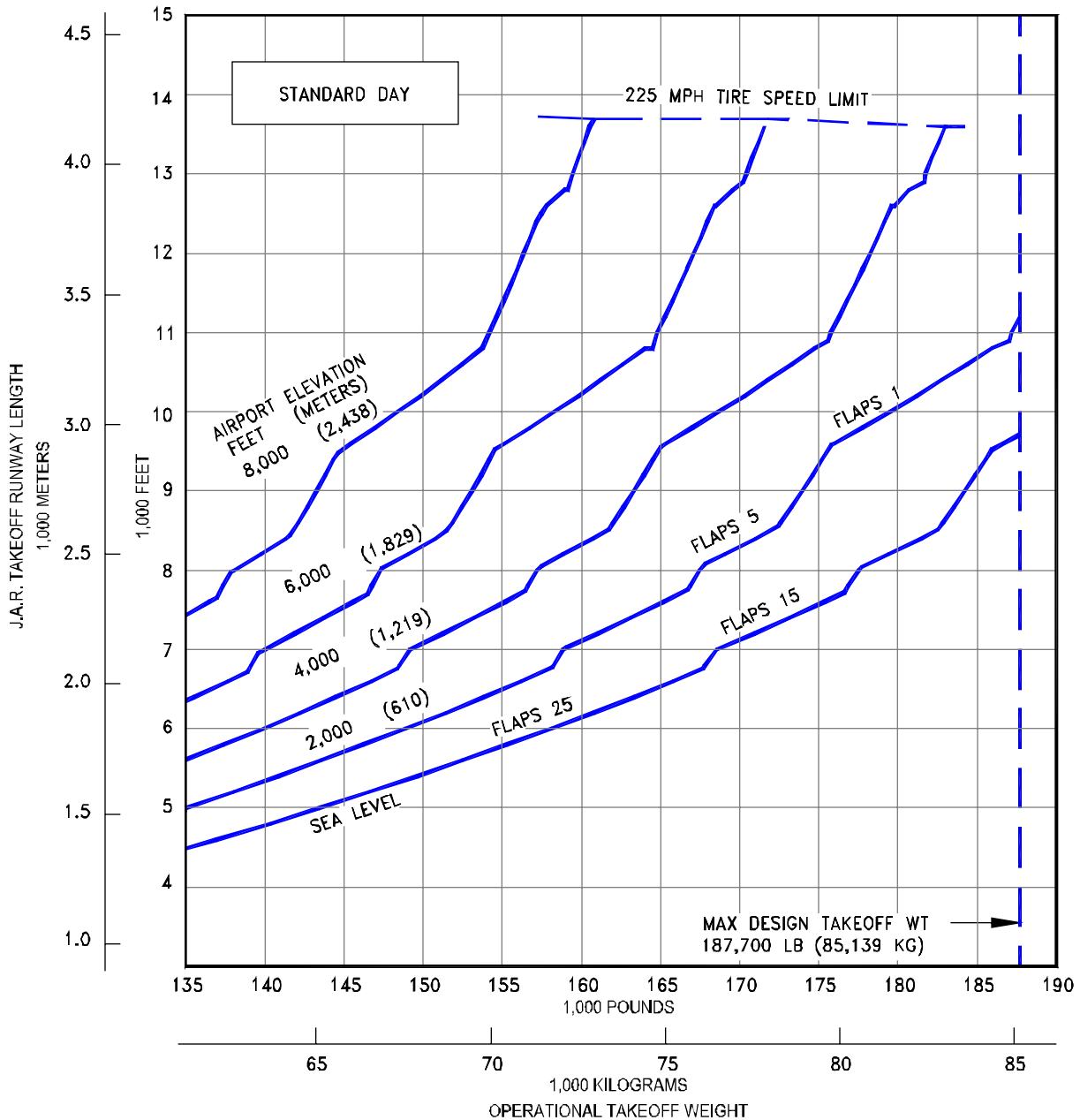

**3.3.149 J.A.R. TAKEOFF RUNWAY LENGTH REQUIREMENTS
STANDARD DAY, WET RUNWAY
MODEL 737-900ER (CFM56-7B27/3F ENGINES AT 27,300 LB SLST)**

PRELIMINARY INFORMATION

NOTES:

- CFM56-7B27/3F ENGINES RATED AT 27,300 LB SLST
- NO ENGINE AIR BLEED FOR AIR CONDITIONING
- ZERO WIND, ZERO RUNWAY GRADIENT
- WET SMOOTH RUNWAY SURFACE
- CONSULT WITH USING AIRLINE FOR SPECIFIC OPERATING PROCEDURE PRIOR TO FACILITY DESIGN
- TAKEOFF PERFORMANCE IMPROVEMENTS ARE POSSIBLE USING GROOVED RUNWAY

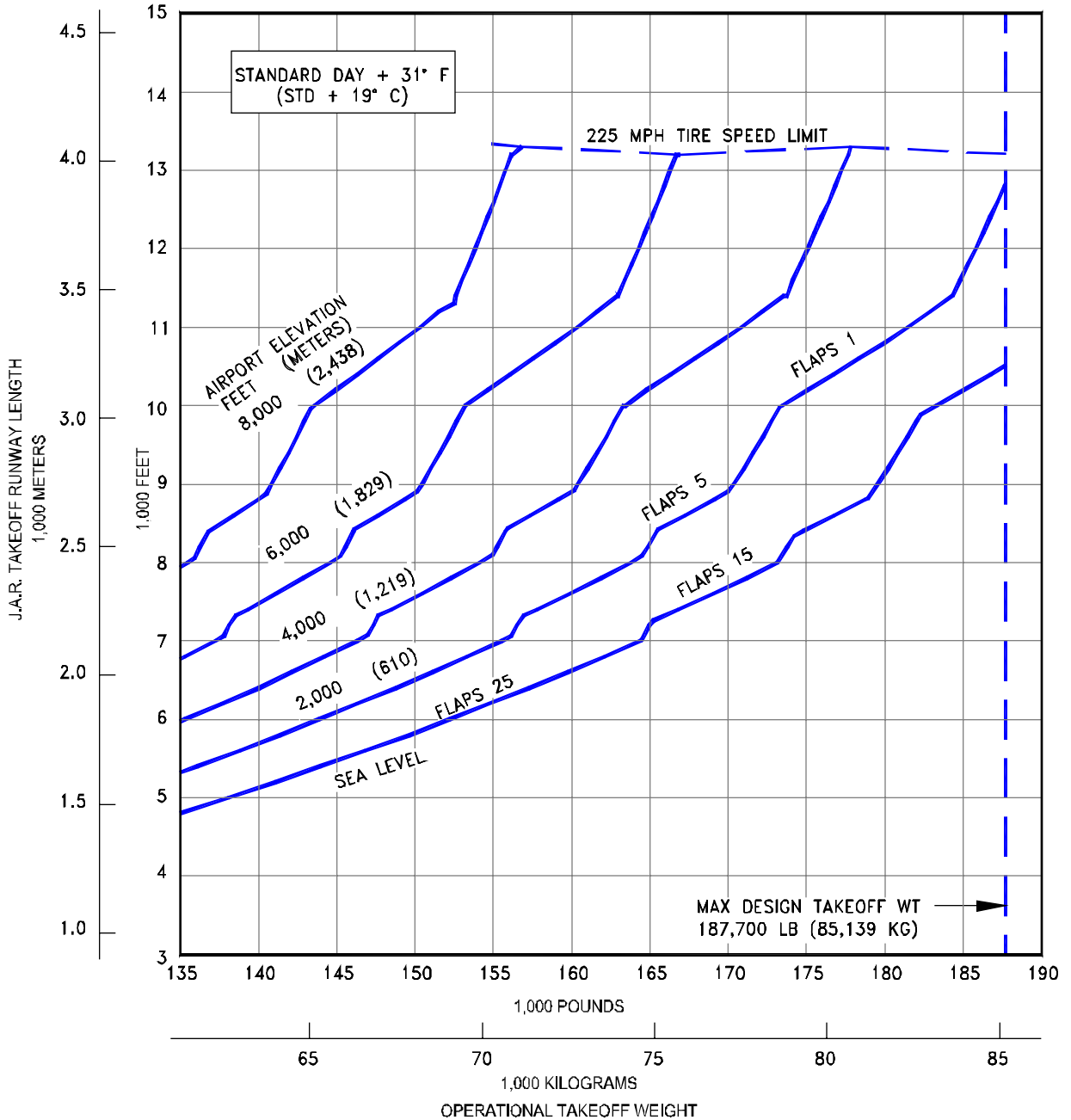

3.3.150 J.A.R. TAKEOFF RUNWAY LENGTH REQUIREMENTS

STANDARD DAY +31°F (STD + 19°C), WET RUNWAY
MODEL 737-900ER (CFM56-7B27/3F ENGINES AT 27,300 LB SLST)

PRELIMINARY INFORMATION

NOTES:

- CFM56-7B27/3B1F ENGINES RATED AT 27,300 LB SLST
- NO ENGINE AIR BLEED FOR AIR CONDITIONING
- ZERO WIND, ZERO RUNWAY GRADIENT
- DRY RUNWAY SURFACE
- CONSULT WITH USING AIRLINE FOR SPECIFIC OPERATING PROCEDURE PRIOR TO FACILITY DESIGN

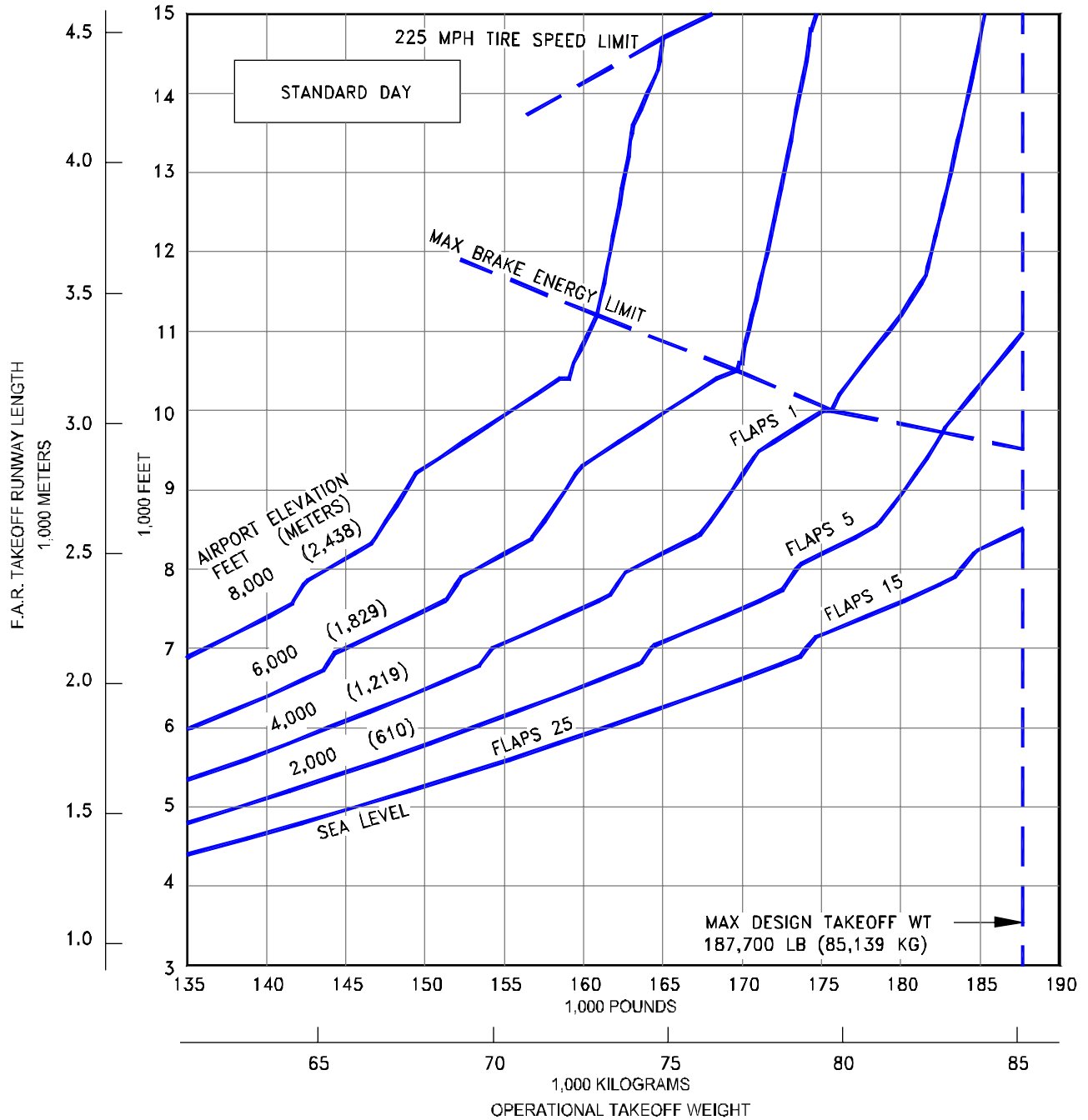

3.3.151 F.A.R. TAKEOFF RUNWAY LENGTH REQUIREMENTS
STANDARD DAY, DRY RUNWAY
MODEL 737-900ER (CFM56-7B27/3B1F ENGINES AT 27,300 LB SLST)

PRELIMINARY INFORMATION

NOTES:

- CFM56-7B27/3B1F ENGINES RATED AT 27,300 LB SLST
- NO ENGINE AIR BLEED FOR AIR CONDITIONING
- ZERO WIND, ZERO RUNWAY GRADIENT
- DRY RUNWAY SURFACE
- CONSULT WITH USING AIRLINE FOR SPECIFIC OPERATING PROCEDURE PRIOR TO FACILITY DESIGN

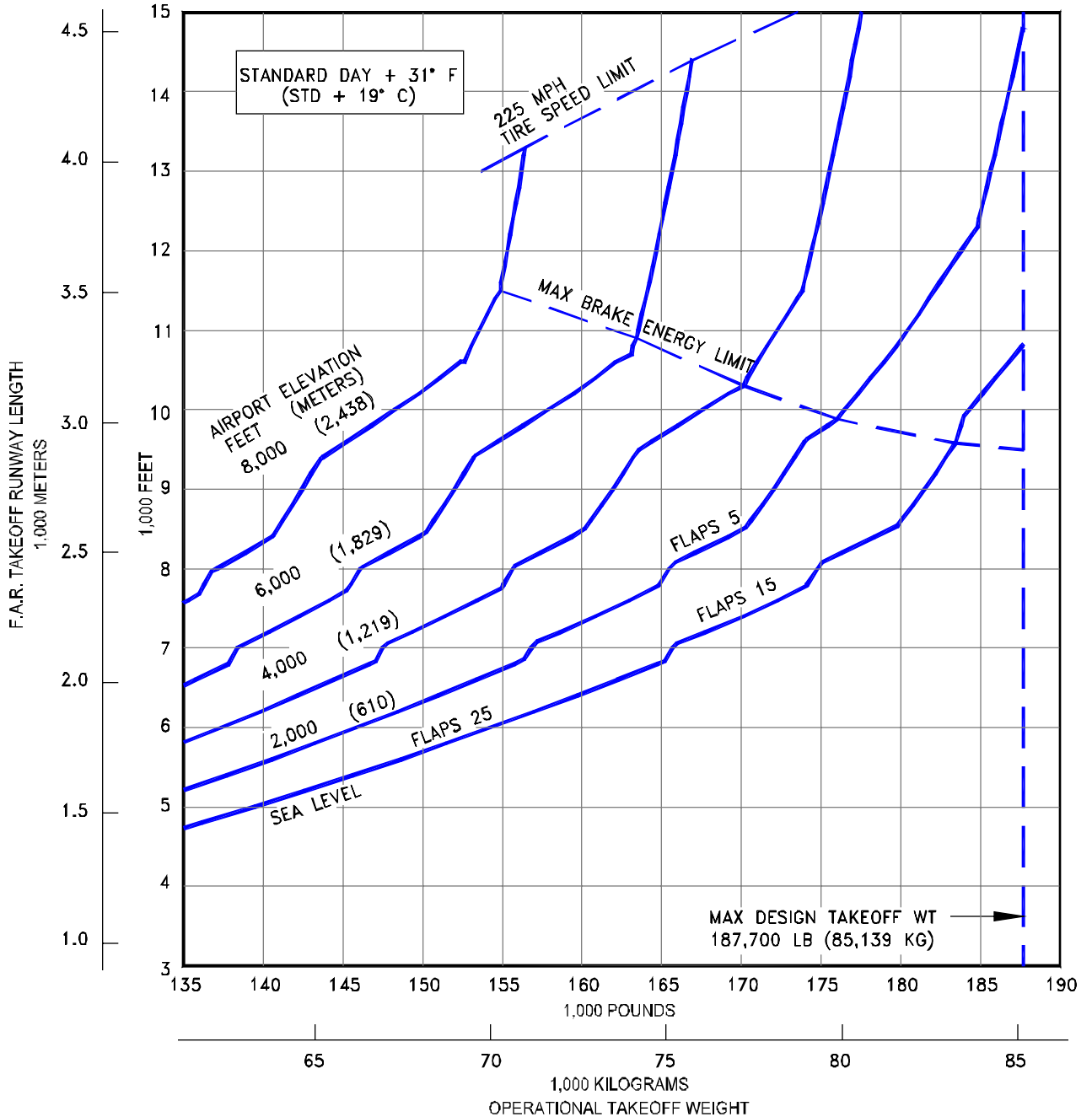

3.3.152 F.A.R. TAKEOFF RUNWAY LENGTH REQUIREMENTS

STANDARD DAY +31°F (STD + 19°C), DRY RUNWAY
MODEL 737-900ER (CFM56-7B27/3B1F ENGINES AT 27,300 LB SLST)

PRELIMINARY INFORMATION

NOTES:

- CFM56-7B273B1F ENGINES RATED AT 27,300 LB SLST
- NO ENGINE AIR BLEED FOR AIR CONDITIONING
- ZERO WIND, ZERO RUNWAY GRADIENT
- WET SMOOTH RUNWAY SURFACE
- CONSULT WITH USING AIRLINE FOR SPECIFIC OPERATING PROCEDURE PRIOR TO FACILITY DESIGN
- TAKEOFF PERFORMANCE IMPROVEMENTS ARE POSSIBLE USING GROOVED RUNWAY

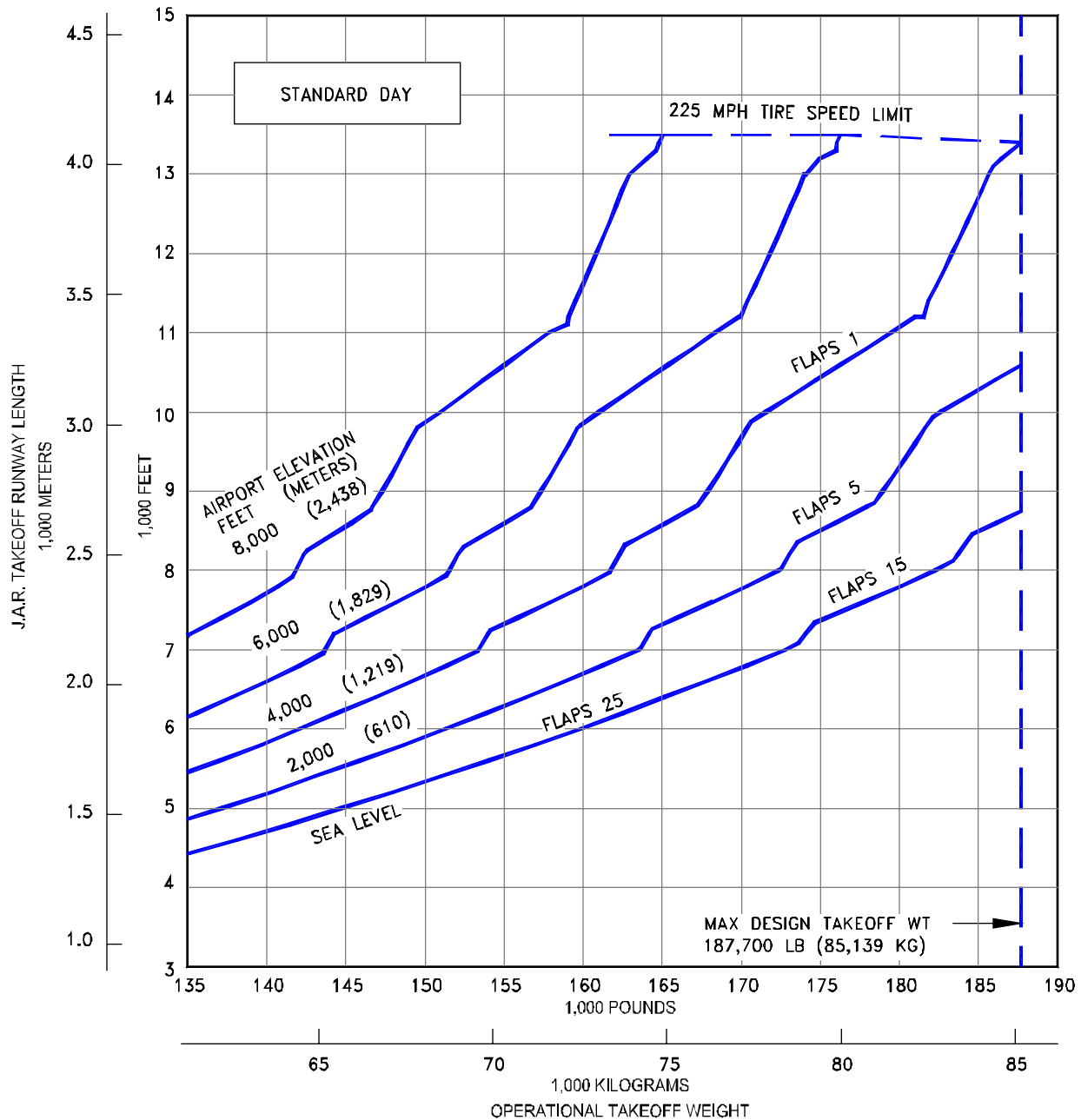

**3.3.153 J.A.R. TAKEOFF RUNWAY LENGTH REQUIREMENTS
STANDARD DAY, WET RUNWAY
MODEL 737-900ER (CFM56-7B27 ENGINES AT 27,300 LB SLST)**

PRELIMINARY INFORMATION

NOTES:

- CFM56-7B27/3B1F ENGINES RATED AT 27,300 LB SLST
- NO ENGINE AIR BLEED FOR AIR CONDITIONING
- ZERO WIND, ZERO RUNWAY GRADIENT
- WET SMOOTH RUNWAY SURFACE
- CONSULT WITH USING AIRLINE FOR SPECIFIC OPERATING PROCEDURE PRIOR TO FACILITY DESIGN
- TAKEOFF PERFORMANCE IMPROVEMENTS ARE POSSIBLE USING GROOVED RUNWAY

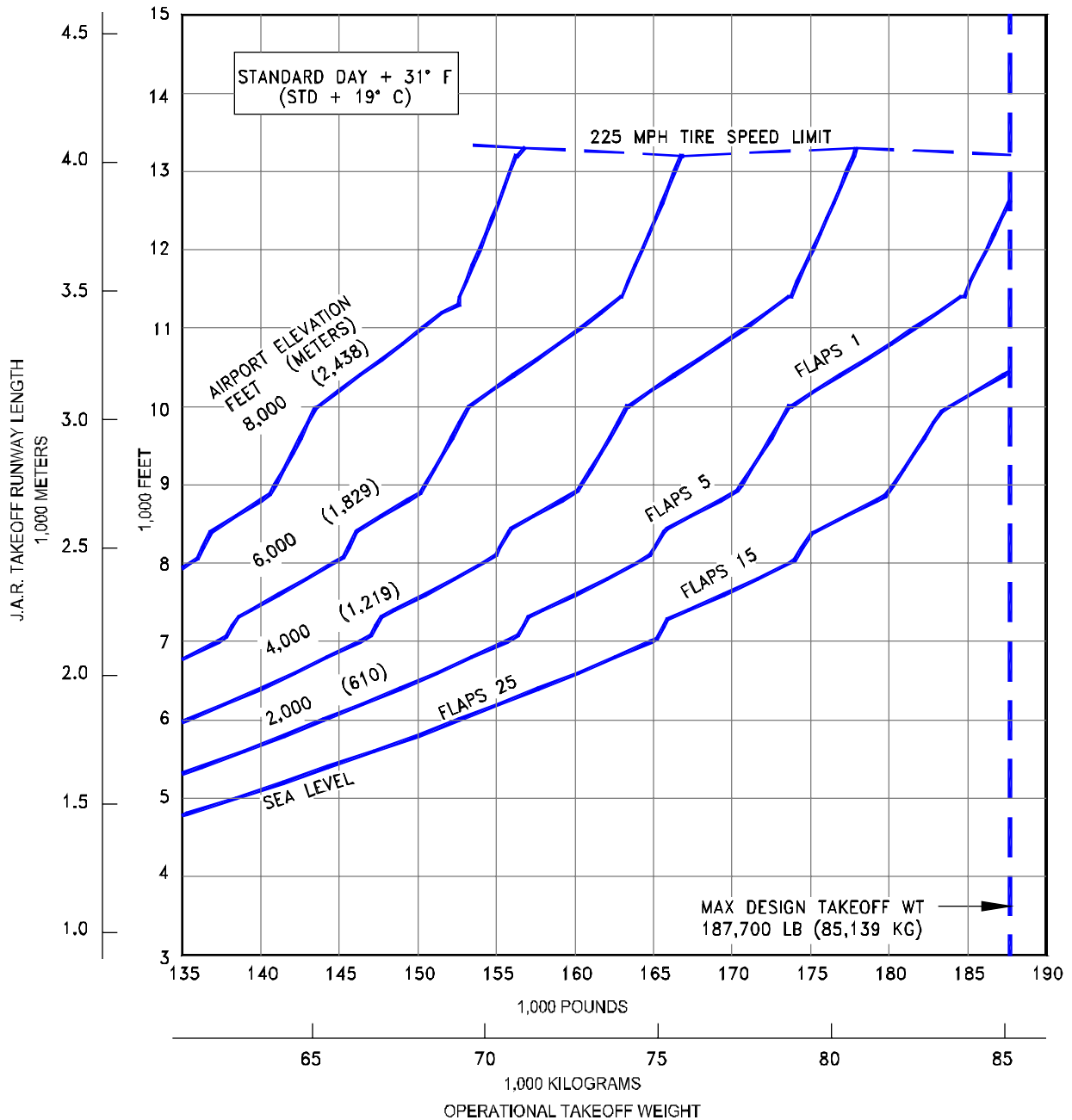

3.3.154 J.A.R. TAKEOFF RUNWAY LENGTH REQUIREMENTS

STANDARD DAY +31°F (STD + 19°C), WET RUNWAY

MODEL 737-900ER (CFM56-7B27/3B1F ENGINES AT 27,300 LB SLST)

PRELIMINARY INFORMATION

NOTES:

- CFM56-7B26/3 ENGINES RATED AT 26,300 LB SLST
- NO ENGINE AIR BLEED FOR AIR CONDITIONING
- ZERO WIND, ZERO RUNWAY GRADIENT
- DRY RUNWAY SURFACE
- CONSULT WITH USING AIRLINE FOR SPECIFIC OPERATING PROCEDURE PRIOR TO FACILITY DESIGN

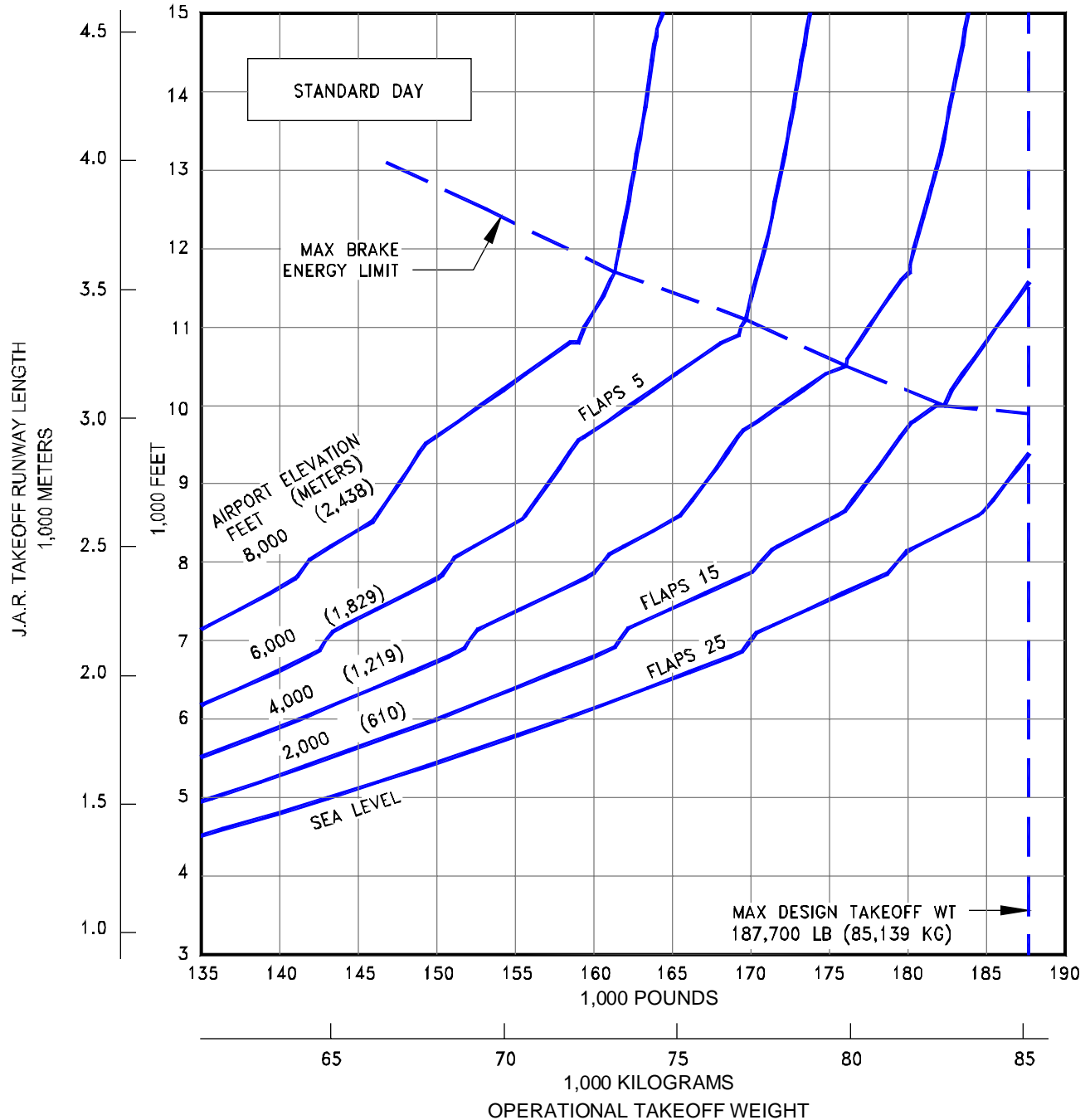

3.3.155 F.A.R. TAKEOFF RUNWAY LENGTH REQUIREMENTS

STANDARD DAY, DRY RUNWAY

MODEL 737-900ER WITH WINGLETS (CFM56-7B26/3 ENGINES AT 26,300 LB SLST)

PRELIMINARY INFORMATION

NOTES:

- CFM56-7B26/3 ENGINES RATED AT 26,300 LB SLST
- NO ENGINE AIR BLEED FOR AIR CONDITIONING
- ZERO WIND, ZERO RUNWAY GRADIENT
- DRY RUNWAY SURFACE
- CONSULT WITH USING AIRLINE FOR SPECIFIC OPERATING PROCEDURE PRIOR TO FACILITY DESIGN

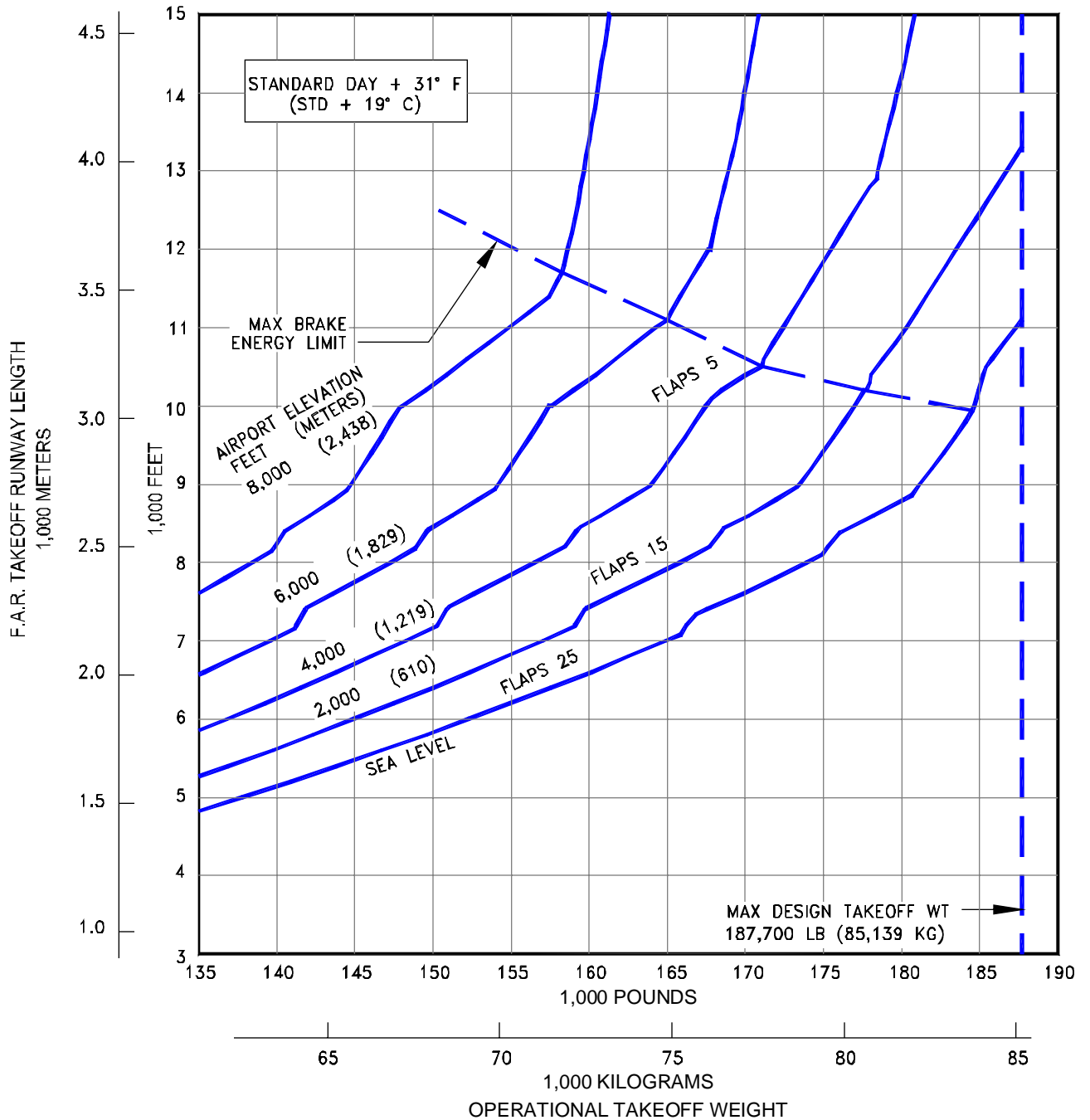

3.3.156 F.A.R. TAKEOFF RUNWAY LENGTH REQUIREMENTS

STANDARD DAY +31°F (STD + 19°C), DRY RUNWAY

MODEL 737-900ER WITH WINGLETS (CFM56-7B26/3 ENGINES AT 26,300 LB SLST)

PRELIMINARY INFORMATION

NOTES:

- CFM56-7B26/3 ENGINES RATED AT 26,300 LB SLST
- NO ENGINE AIR BLEED FOR AIR CONDITIONING
- ZERO WIND, ZERO RUNWAY GRADIENT
- WET SMOOTH RUNWAY SURFACE
- CONSULT WITH USING AIRLINE FOR SPECIFIC OPERATING PROCEDURE PRIOR TO FACILITY DESIGN

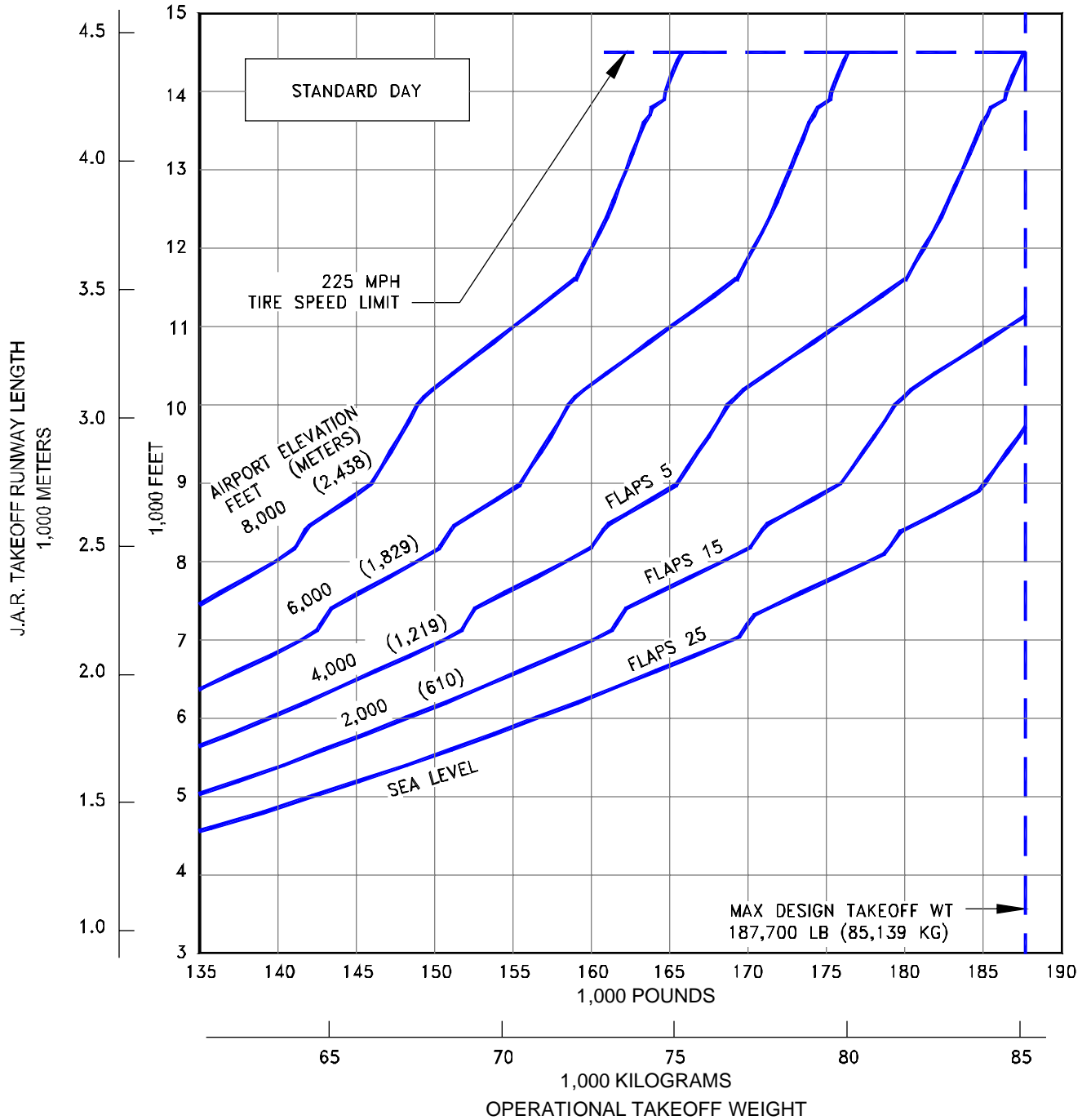

3.3.157 J.A.R. TAKEOFF RUNWAY LENGTH REQUIREMENTS

STANDARD DAY, WET RUNWAY

MODEL 737-900ER WITH WINGLETS (CFM56-7B26/3 ENGINES AT 26,300 LB SLST)

D6-58325-6

PRELIMINARY INFORMATION

NOTES:

- CFM56-7B26/3 ENGINES RATED AT 26,300 LB SLST
- NO ENGINE AIR BLEED FOR AIR CONDITIONING
- ZERO WIND, ZERO RUNWAY GRADIENT
- WET SMOOTH RUNWAY SURFACE
- CONSULT WITH USING AIRLINE FOR SPECIFIC OPERATING PROCEDURE PRIOR TO FACILITY DESIGN

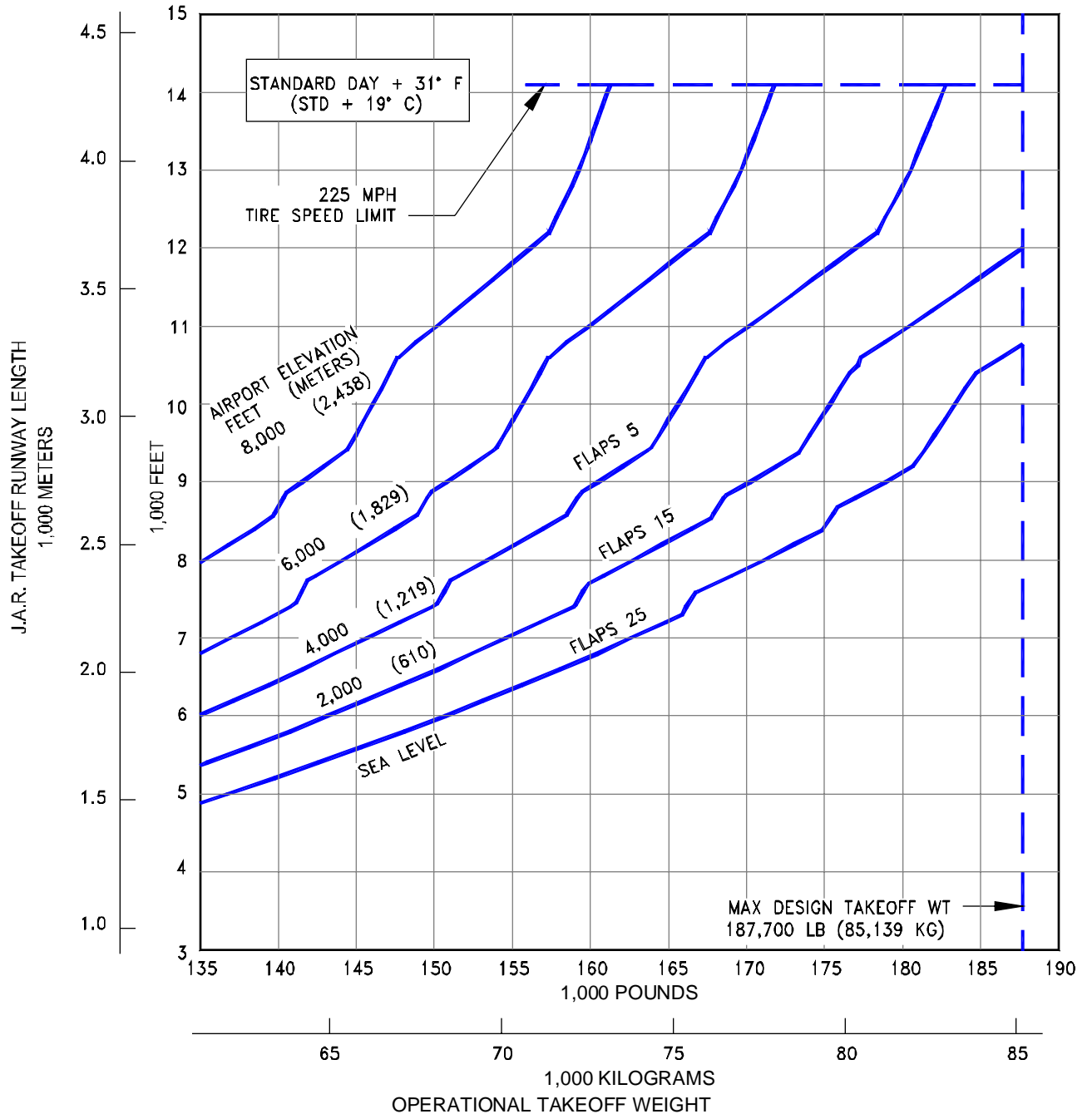

3.3.158 J.A.R. TAKEOFF RUNWAY LENGTH REQUIREMENTS

STANDARD DAY +31°F (STD + 19°C), WET RUNWAY

MODEL 737-900ER WITH WINGLETS (CFM56-7B26/3 ENGINES AT 26,300 LB SLST)

PRELIMINARY INFORMATION

NOTES:

- CFM56-7B27/3F ENGINES RATED AT 27,300 LB SLST
- NO ENGINE AIR BLEED FOR AIR CONDITIONING
- ZERO WIND, ZERO RUNWAY GRADIENT
- DRY RUNWAY SURFACE
- CONSULT WITH USING AIRLINE FOR SPECIFIC OPERATING PROCEDURE PRIOR TO FACILITY DESIGN

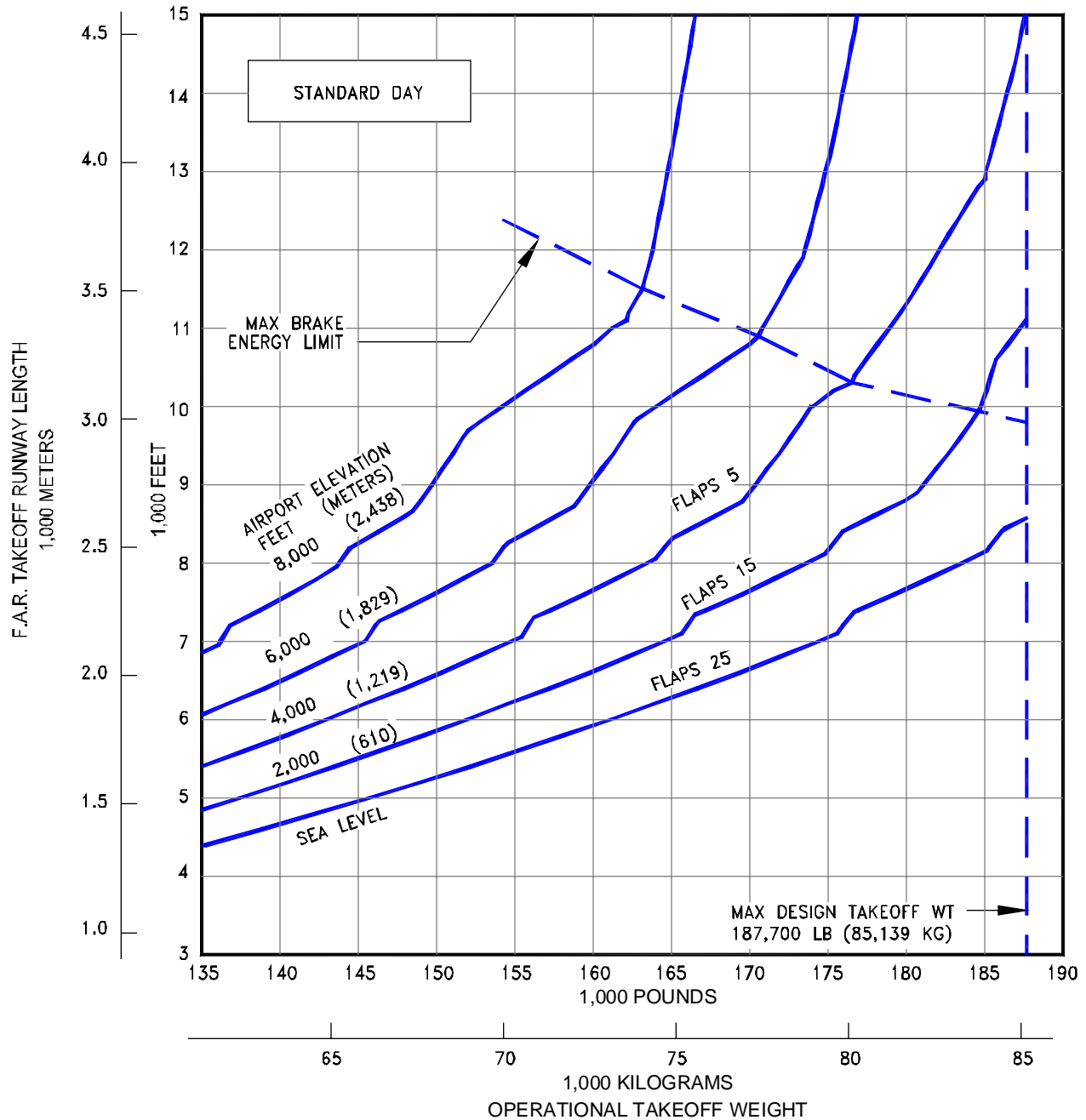

3.3.159 F.A.R. TAKEOFF RUNWAY LENGTH REQUIREMENTS

STANDARD DAY, DRY RUNWAY

MODEL 737-900ER WITH WINGLETS (CFM56-7B27/3F ENGINES AT 27,300 LB SLST)

PRELIMINARY INFORMATION

NOTES:

- CFM56-7B27/3F ENGINES RATED AT 27,300 LB SLST
- NO ENGINE AIR BLEED FOR AIR CONDITIONING
- ZERO WIND, ZERO RUNWAY GRADIENT
- DRY RUNWAY SURFACE
- CONSULT WITH USING AIRLINE FOR SPECIFIC OPERATING PROCEDURE PRIOR TO FACILITY DESIGN

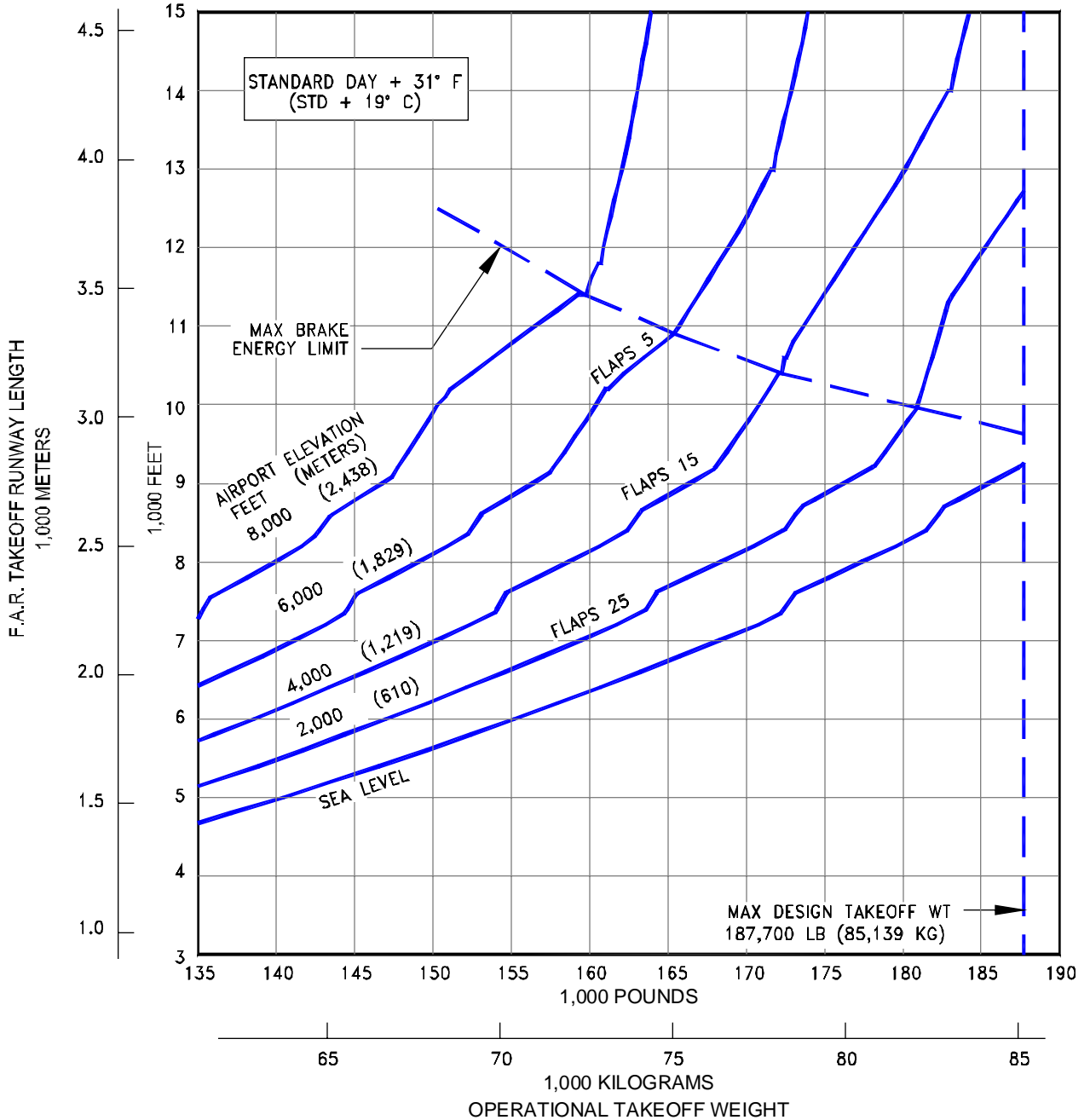

3.3.160 F.A.R. TAKEOFF RUNWAY LENGTH REQUIREMENTS

STANDARD DAY +31°F (STD + 19°C), DRY RUNWAY

MODEL 737-900ER WITH WINGLETS (CFM56-7B27/3F ENGINES AT 27,300 LB SLST)

PRELIMINARY INFORMATION

NOTES:

- CFM56-7B273F ENGINES RATED AT 27,300 LB SLST
- NO ENGINE AIR BLEED FOR AIR CONDITIONING
- ZERO WIND, ZERO RUNWAY GRADIENT
- WET SMOOTH RUNWAY SURFACE
- ◆ CONSULT WITH USING AIRLINE FOR SPECIFIC OPERATING PROCEDURE PRIOR TO FACILITY DESIGN

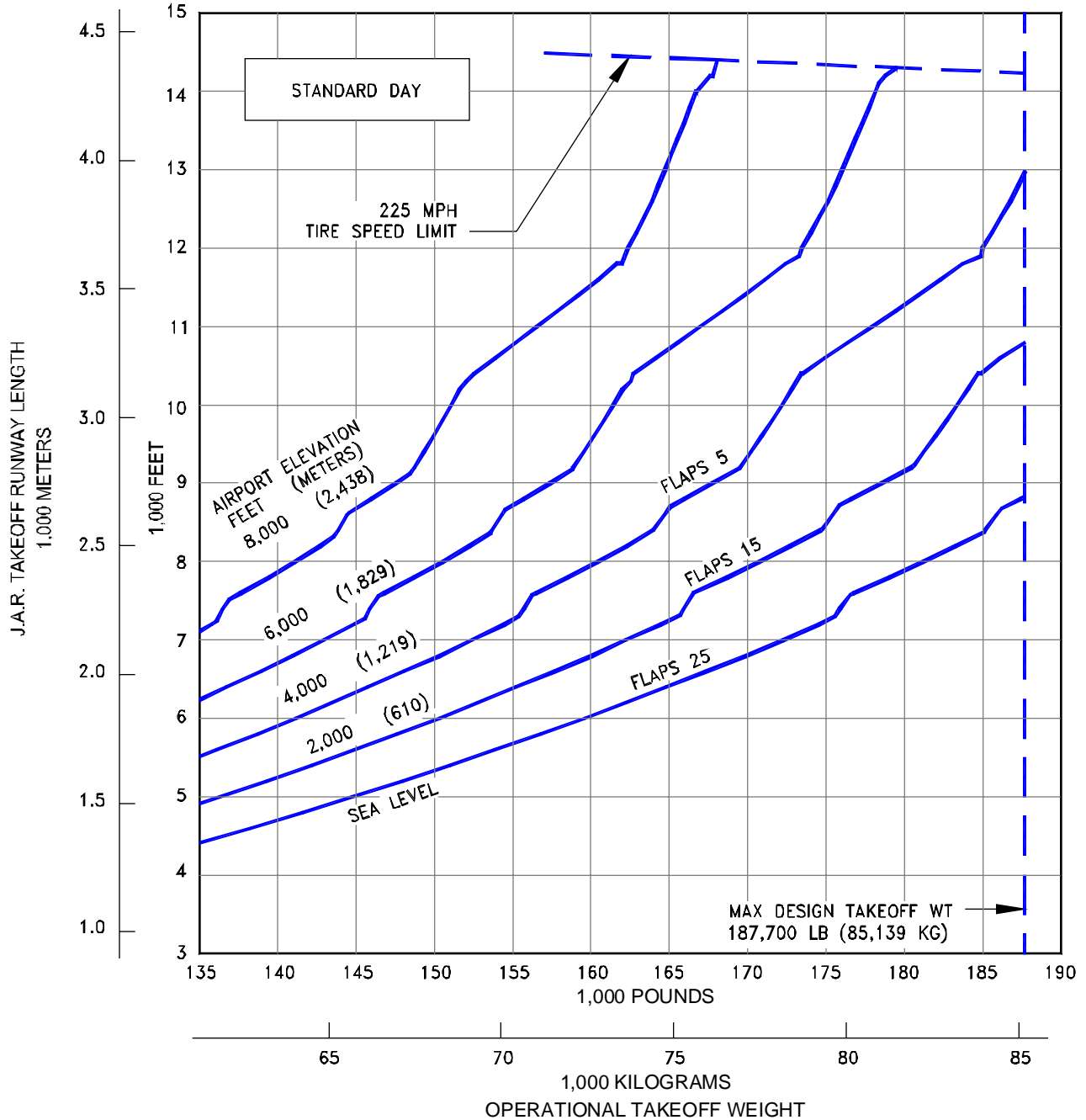

3.3.161 J.A.R. TAKEOFF RUNWAY LENGTH REQUIREMENTS

STANDARD DAY, WET RUNWAY

MODEL 737-900ER WITH WINGLETS (CFM56-7B273F ENGINES AT 27,300 LB SLST)

PRELIMINARY INFORMATION

NOTES:

- CFM56-7B27/3F ENGINES RATED AT 27,300 LB SLST
- NO ENGINE AIR BLEED FOR AIR CONDITIONING
- ZERO WIND, ZERO RUNWAY GRADIENT
- WET SMOOTH RUNWAY SURFACE
- CONSULT WITH USING AIRLINE FOR SPECIFIC OPERATING PROCEDURE PRIOR TO FACILITY DESIGN

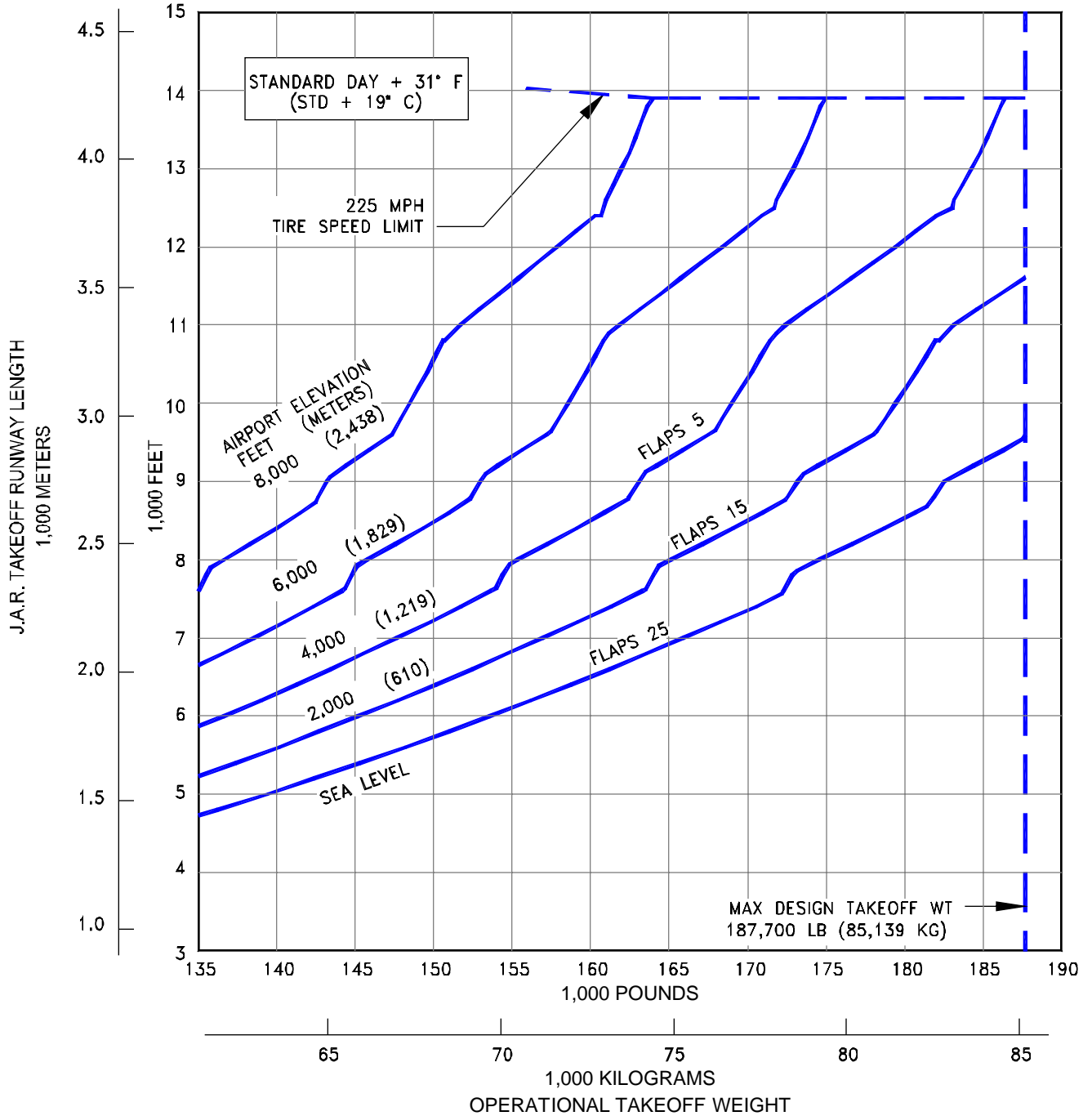

3.3.162 J.A.R. TAKEOFF RUNWAY LENGTH REQUIREMENTS

STANDARD DAY +31°F (STD + 19°C), WET RUNWAY

MODEL 737-900ER WITH WINGLETS (CFM56-7B27/3F ENGINES AT 27,300 LB SLST)

PRELIMINARY INFORMATION

NOTES:

- CFM56-7B27/3B1F ENGINES RATED AT 27,300 LB SLST
- NO ENGINE AIR BLEED FOR AIR CONDITIONING
- ZERO WIND, ZERO RUNWAY GRADIENT
- DRY RUNWAY SURFACE
- CONSULT WITH USING AIRLINE FOR SPECIFIC OPERATING PROCEDURE PRIOR TO FACILITY DESIGN

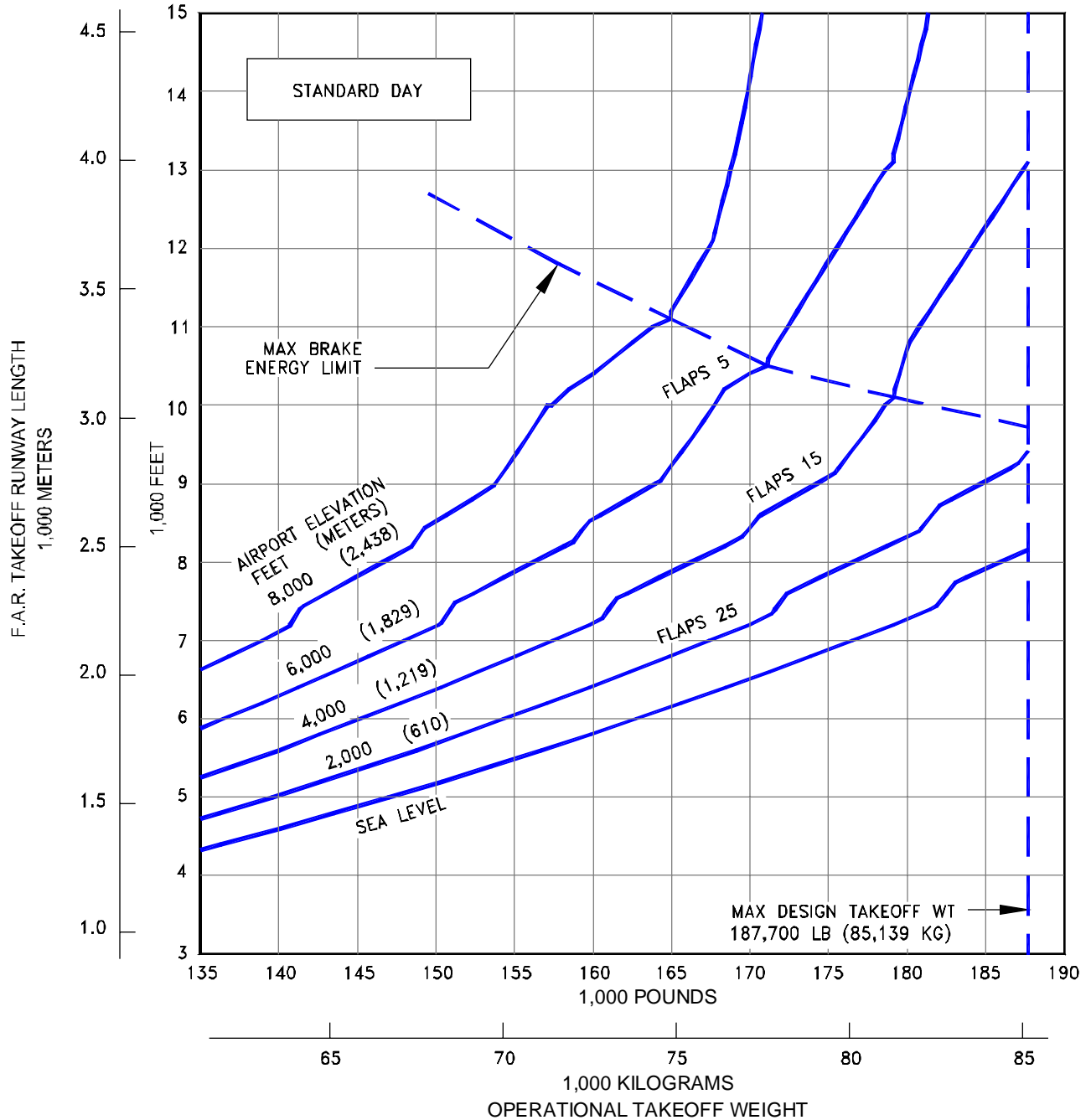

3.3.163 F.A.R. TAKEOFF RUNWAY LENGTH REQUIREMENTS

STANDARD DAY, DRY RUNWAY

MODEL 737-900ER WITH WINGLETS (CFM56-7B27/3B1F ENGINES AT 27,300 LB SLST)

PRELIMINARY INFORMATION

NOTES:

- CFM56-7B27/3B1F ENGINES RATED AT 27,300 LB SLST
- NO ENGINE AIR BLEED FOR AIR CONDITIONING
- ZERO WIND, ZERO RUNWAY GRADIENT
- DRY RUNWAY SURFACE
- CONSULT WITH USING AIRLINE FOR SPECIFIC OPERATING PROCEDURE PRIOR TO FACILITY DESIGN

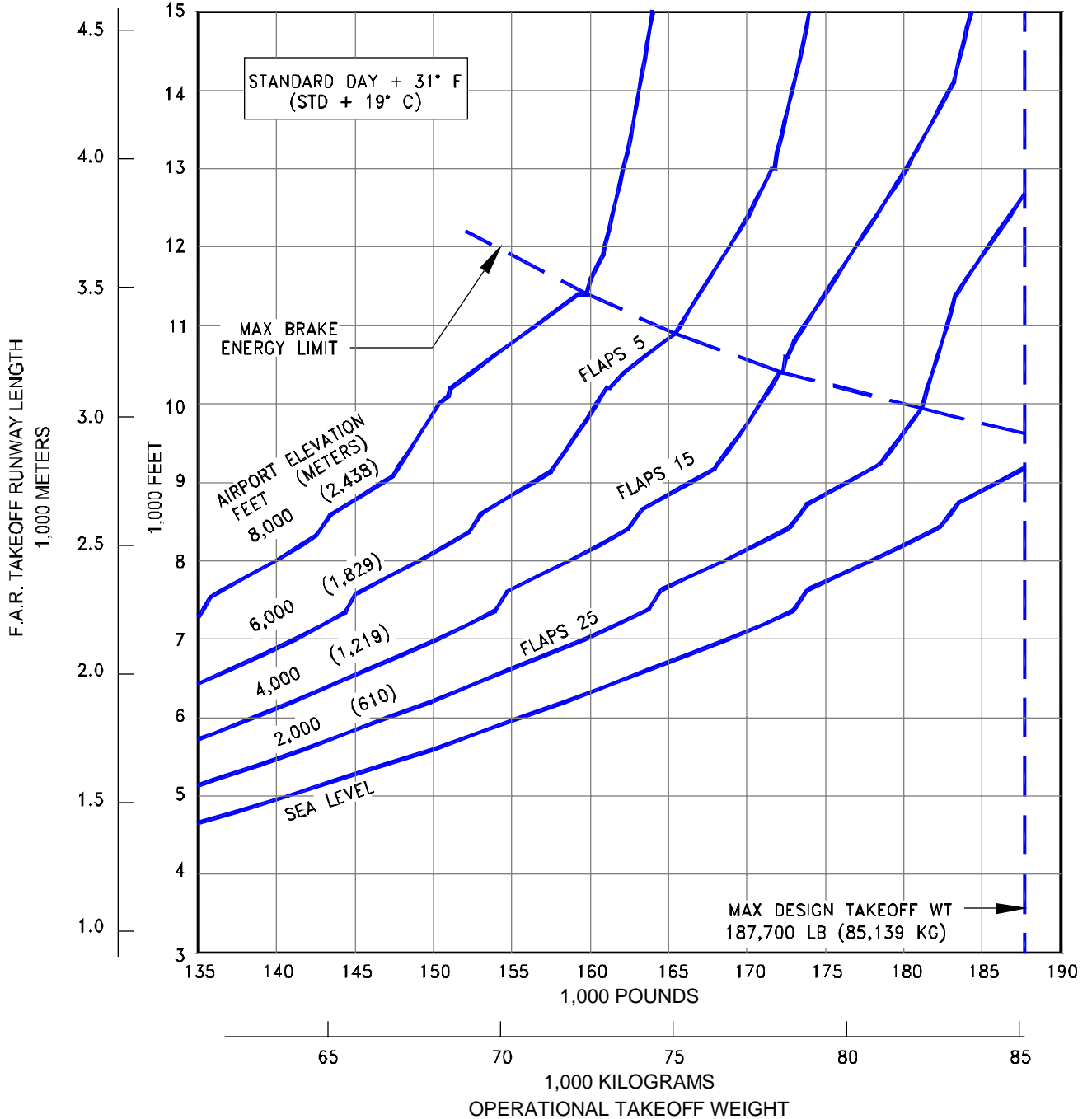

3.3.164 F.A.R. TAKEOFF RUNWAY LENGTH REQUIREMENTS

STANDARD DAY +31°F (STD + 19°C), DRY RUNWAY

MODEL 737-900ER WITH WINGLETS (CFM56-7B27/3B1F ENGINES AT 27,300 LB SLST)

PRELIMINARY INFORMATION

NOTES:

- CFM56-7B27/3B1F ENGINES RATED AT 27,300 LB SLST
- NO ENGINE AIR BLEED FOR AIR CONDITIONING
- ZERO WIND, ZERO RUNWAY GRADIENT
- WET SMOOTH RUNWAY SURFACE
- CONSULT WITH USING AIRLINE FOR SPECIFIC OPERATING PROCEDURE PRIOR TO FACILITY DESIGN

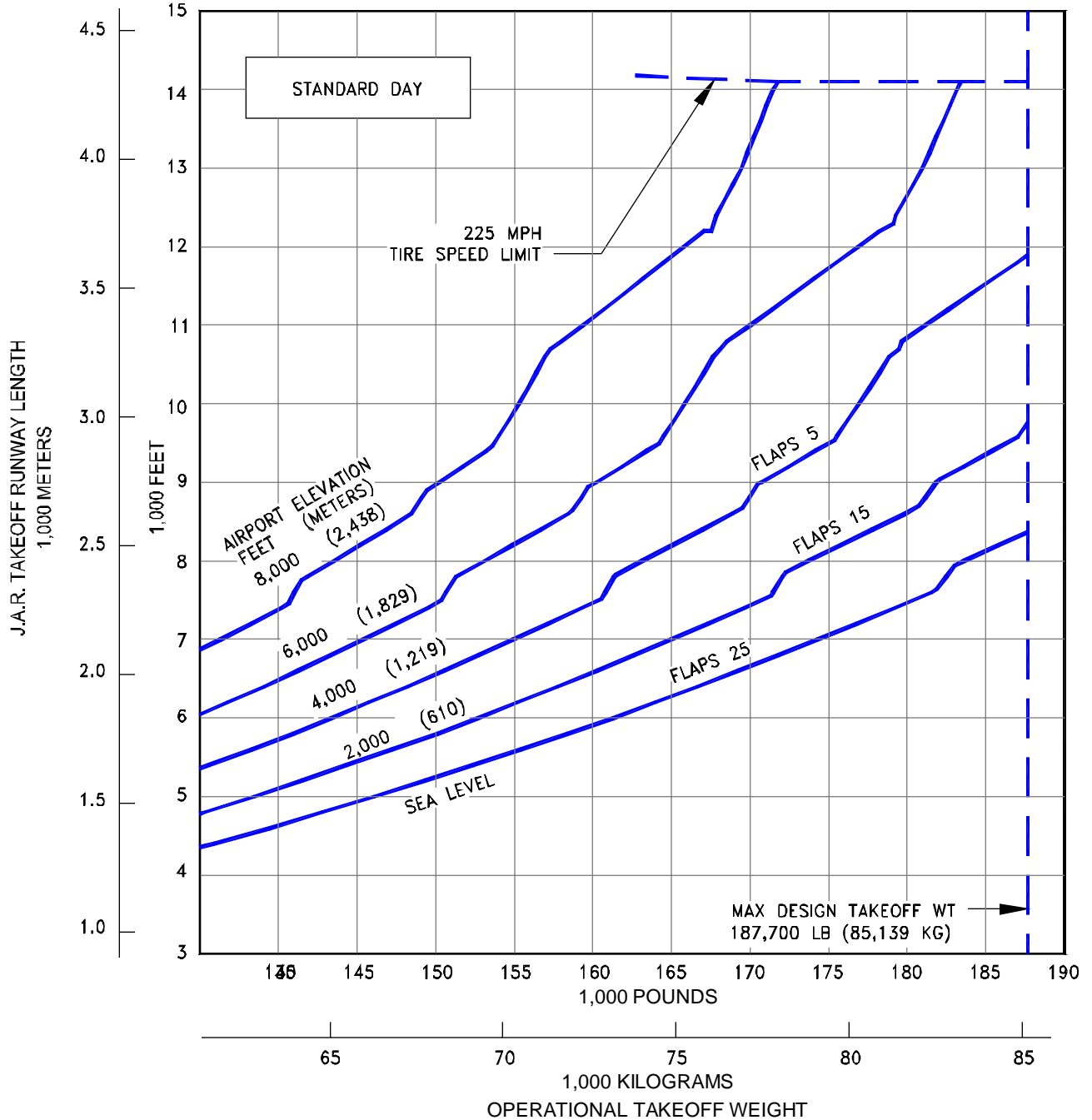

**3.3.165 J.A.R. TAKEOFF RUNWAY LENGTH REQUIREMENTS
STANDARD DAY, WET RUNWAY**

MODEL 737-900ER WITH WINGLETS (CFM56-7B27/3B1F ENGINES AT 27,300 LB SLST)

PRELIMINARY INFORMATION

NOTES:

- CFM56-7B27/3B1F ENGINES RATED AT 27,300 LB SLST
- NO ENGINE AIR BLEED FOR AIR CONDITIONING
- ZERO WIND, ZERO RUNWAY GRADIENT
- WET SMOOTH RUNWAY SURFACE
- CONSULT WITH USING AIRLINE FOR SPECIFIC OPERATING PROCEDURE PRIOR TO FACILITY DESIGN

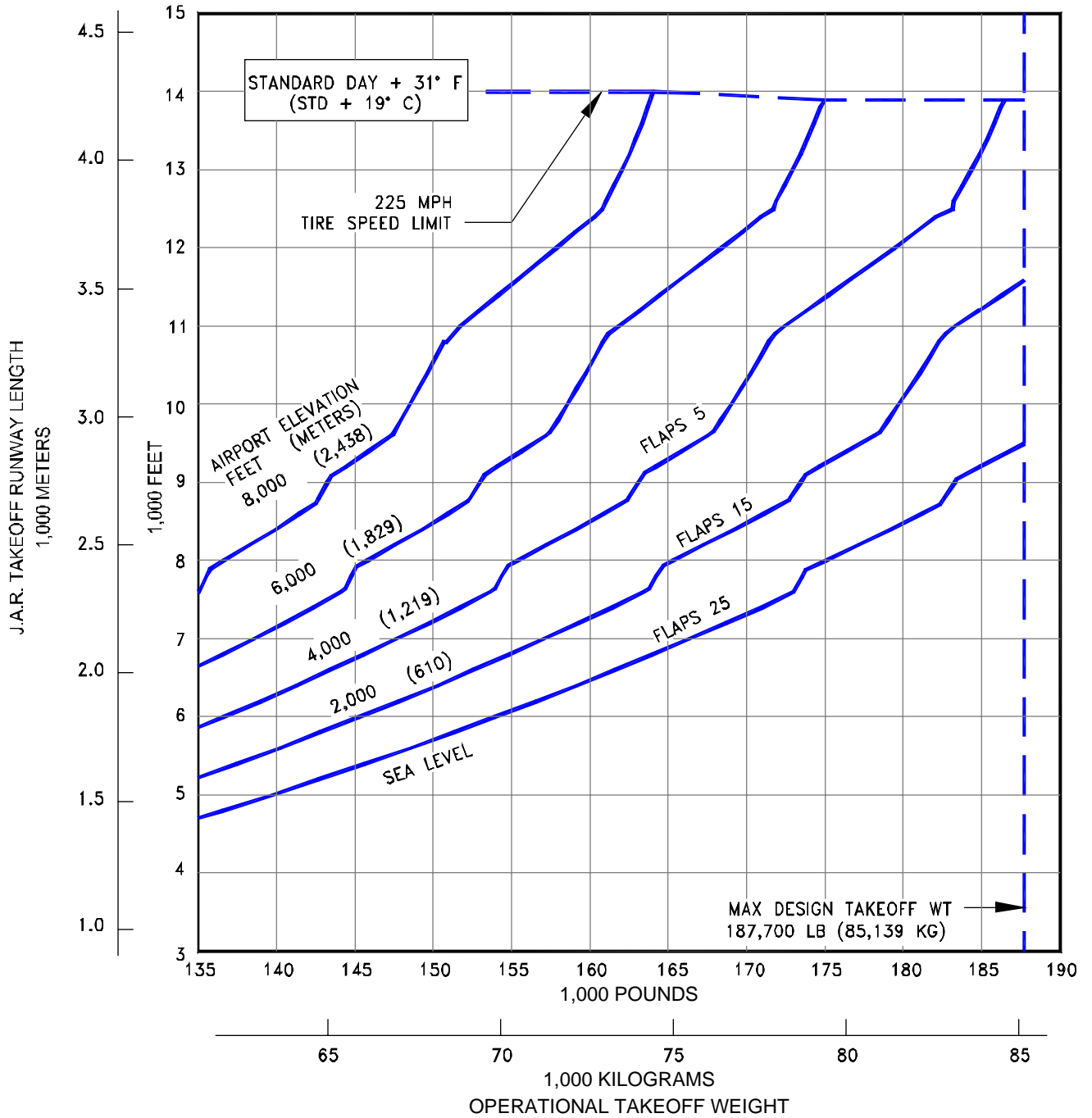

3.3.166 J.A.R. TAKEOFF RUNWAY LENGTH REQUIREMENTS

STANDARD DAY +31°F (STD + 19°C), WET RUNWAY

MODEL 737-900ER WITH WINGLETS (CFM56-7B27/3B1F ENGINES AT 27,300 LB SLST)

NOTES:

- * $V_{APP} = 1.3V_s$
- * ZERO WIND
- * FLAP POSITION 40
- * AUTOMATIC SPEED BRAKES
- * CONSULT WITH USING AIRLINE FOR SPECIFIC PROCEDURE PRIOR TO FACILITY DESIGN

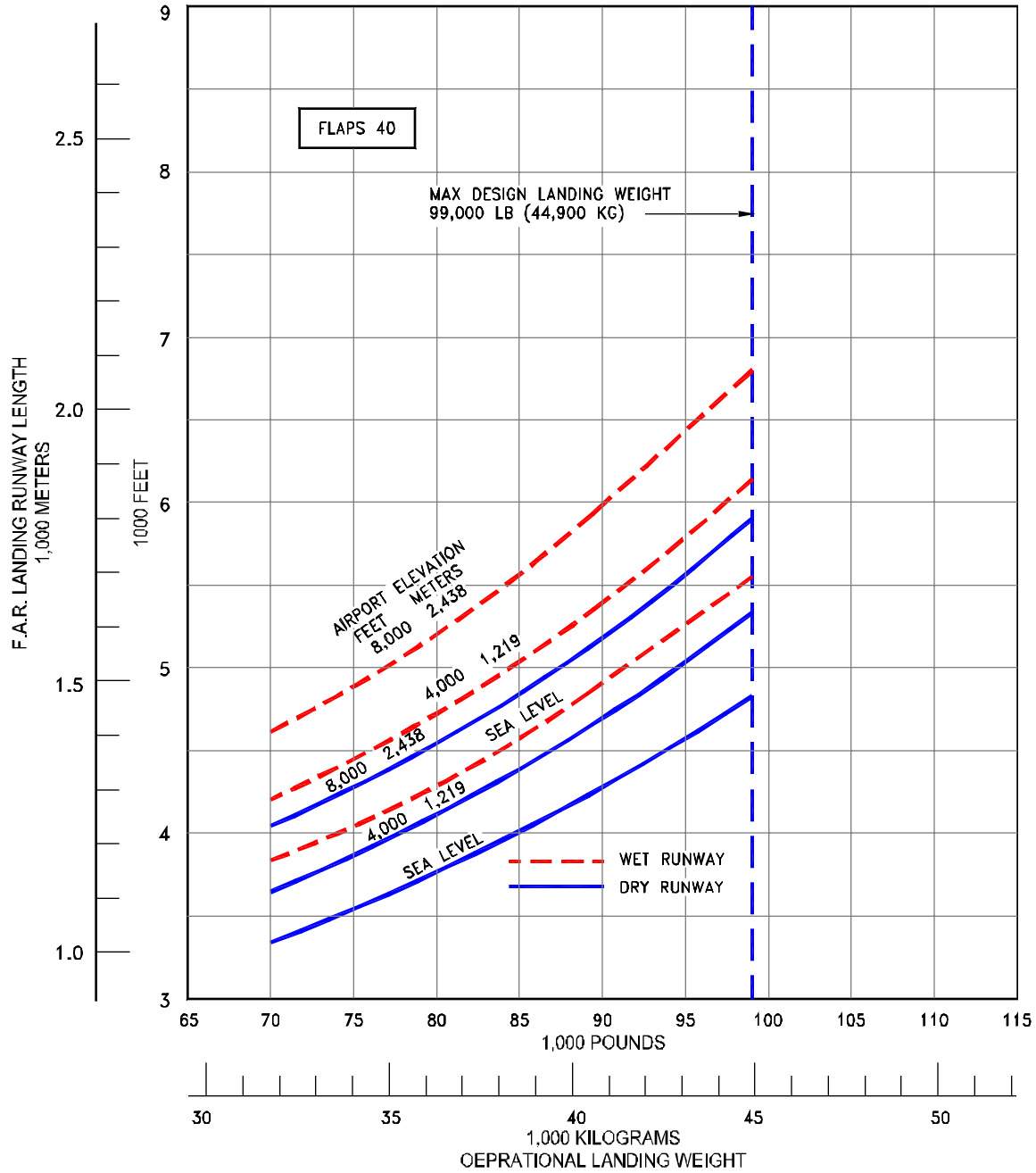

3.4.1 F.A.R. LANDING RUNWAY LENGTH REQUIREMENTS - FLAPS 40
 MODEL 737-100

NOTES:

- * $V_{APP} = 1.3V_s$
- * ZERO WIND
- * FLAP POSITION 30
- * AUTOMATIC SPEED BRAKES
- * CONSULT WITH USING AIRLINE FOR SPECIFIC PROCEDURE PRIOR TO FACILITY DESIGN

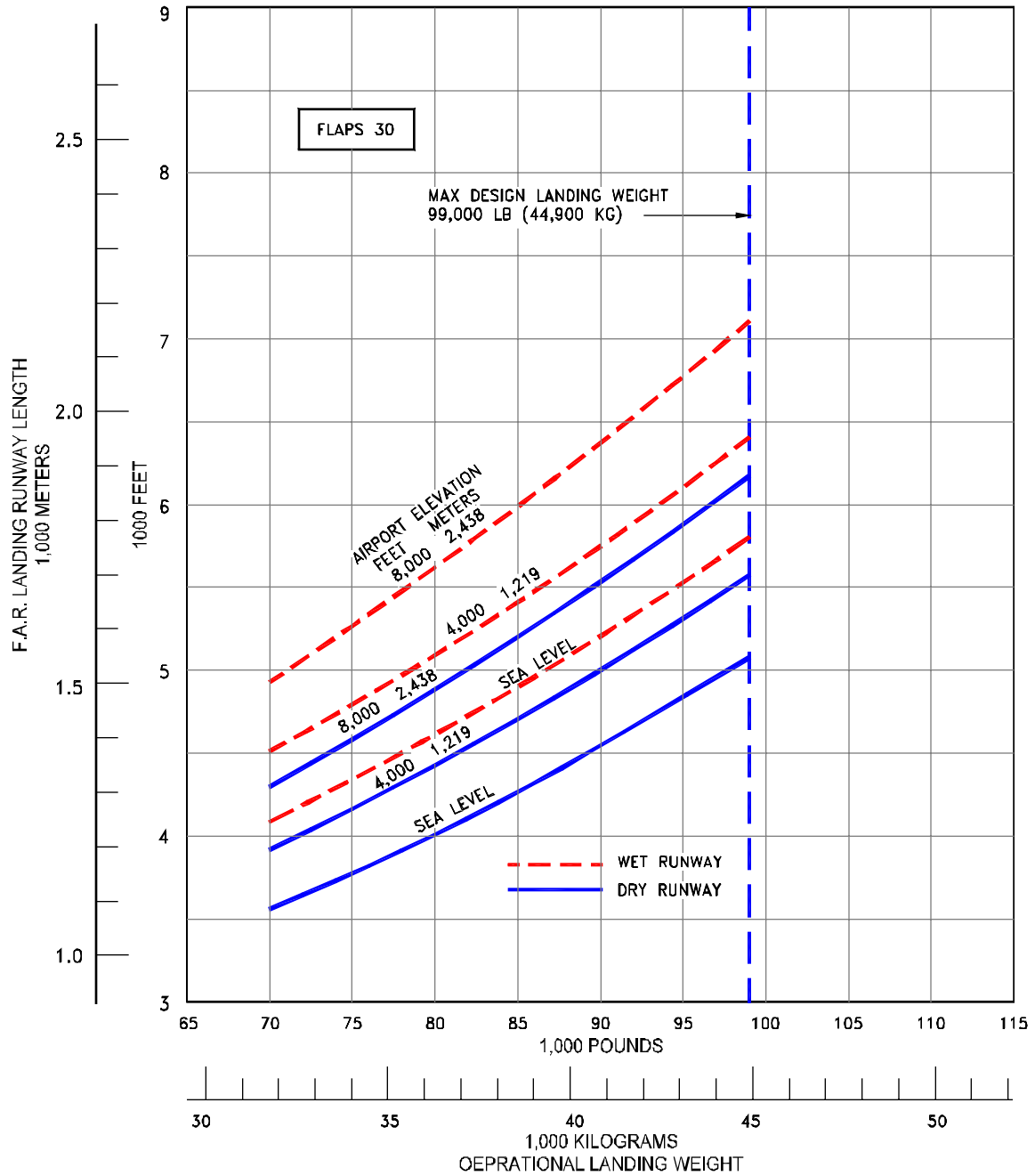

3.4.2 F.A.R. LANDING RUNWAY LENGTH REQUIREMENTS - FLAPS 30
MODEL 737-100

NOTES:

- * $V_{APP} = 1.3V_s$
- * ZERO WIND
- * FLAP POSITION 25
- * AUTOMATIC SPEED BRAKES
- * CONSULT WITH USING AIRLINE FOR SPECIFIC PROCEDURE PRIOR TO FACILITY DESIGN

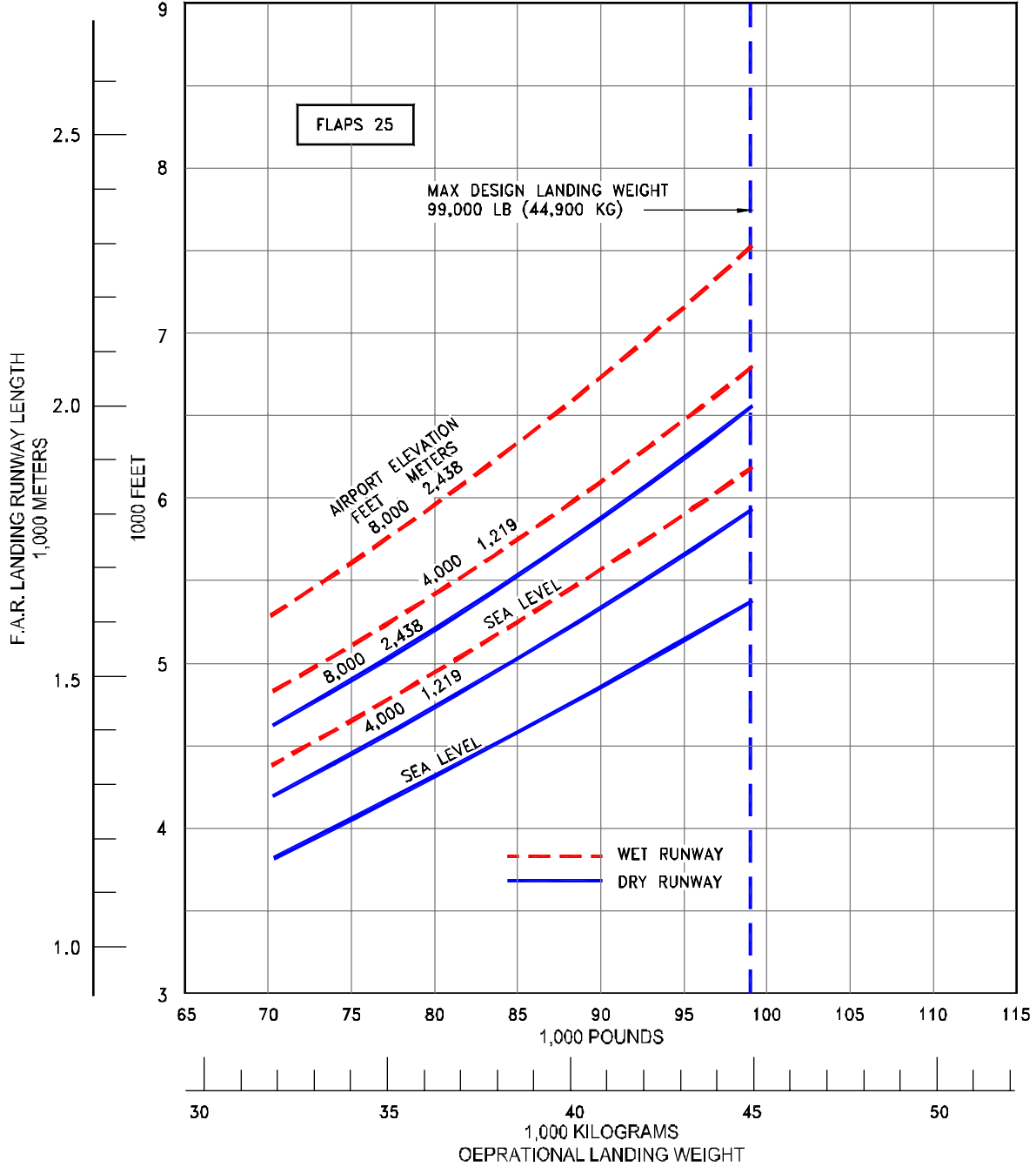

3.4.3 F.A.R. LANDING RUNWAY LENGTH REQUIREMENTS - FLAPS 25
 MODEL 737-100

NOTES:

- * $V_{APP} = 1.3V_S$
- * ZERO WIND
- * FLAP POSITION 40
- * AUTOMATIC SPEED BRAKES
- * CONSULT WITH USING AIRLINE FOR SPECIFIC PROCEDURE PRIOR TO FACILITY DESIGN

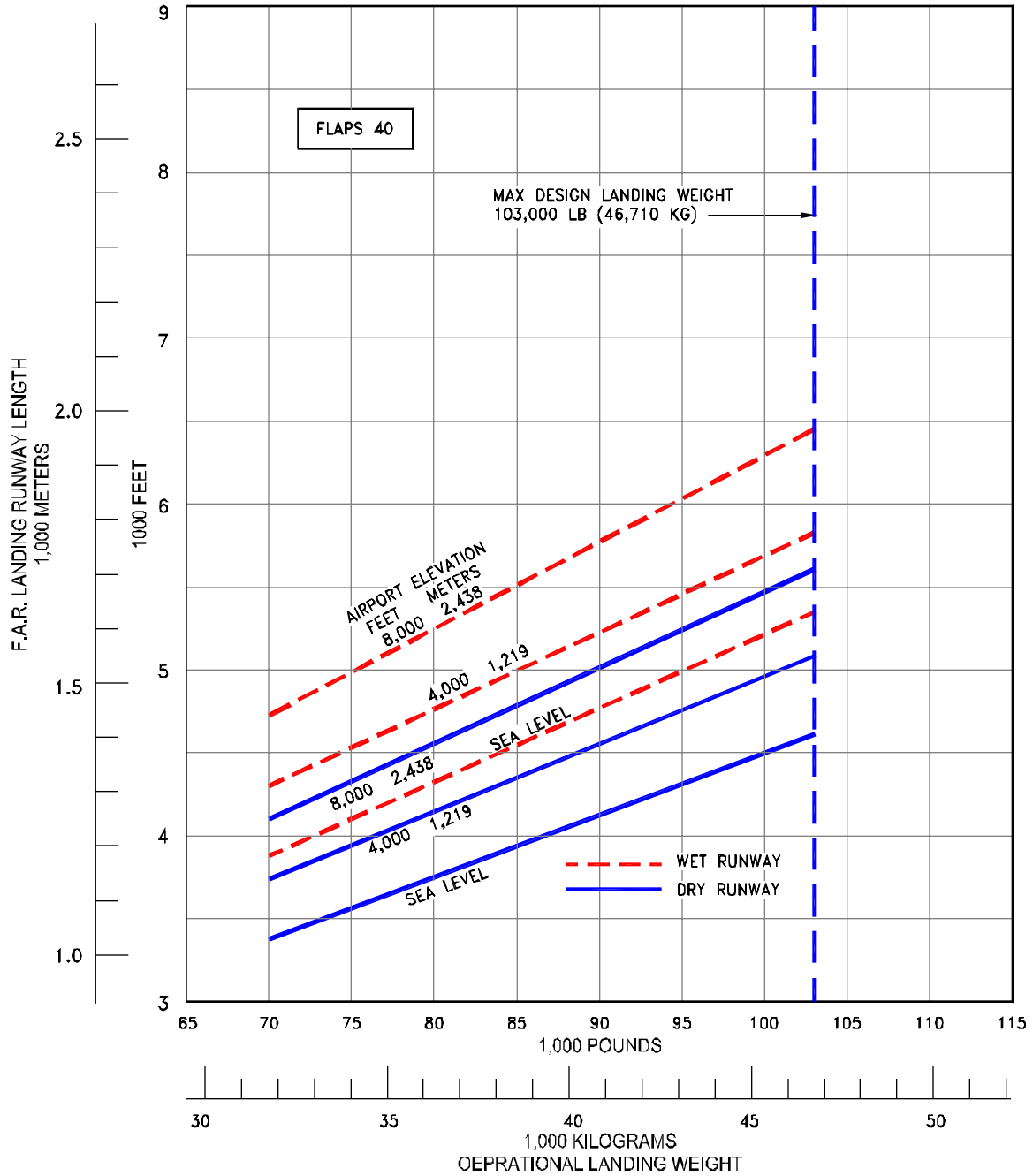

3.4.4 F.A.R. LANDING RUNWAY LENGTH REQUIREMENTS - FLAPS 40
 MODEL 737-200, -200C

NOTES:

- * $V_{APP} = 1.3V_S$
- * ZERO WIND
- * FLAP POSITION 30
- * AUTOMATIC SPEED BRAKES
- * CONSULT WITH USING AIRLINE FOR SPECIFIC PROCEDURE PRIOR TO FACILITY DESIGN

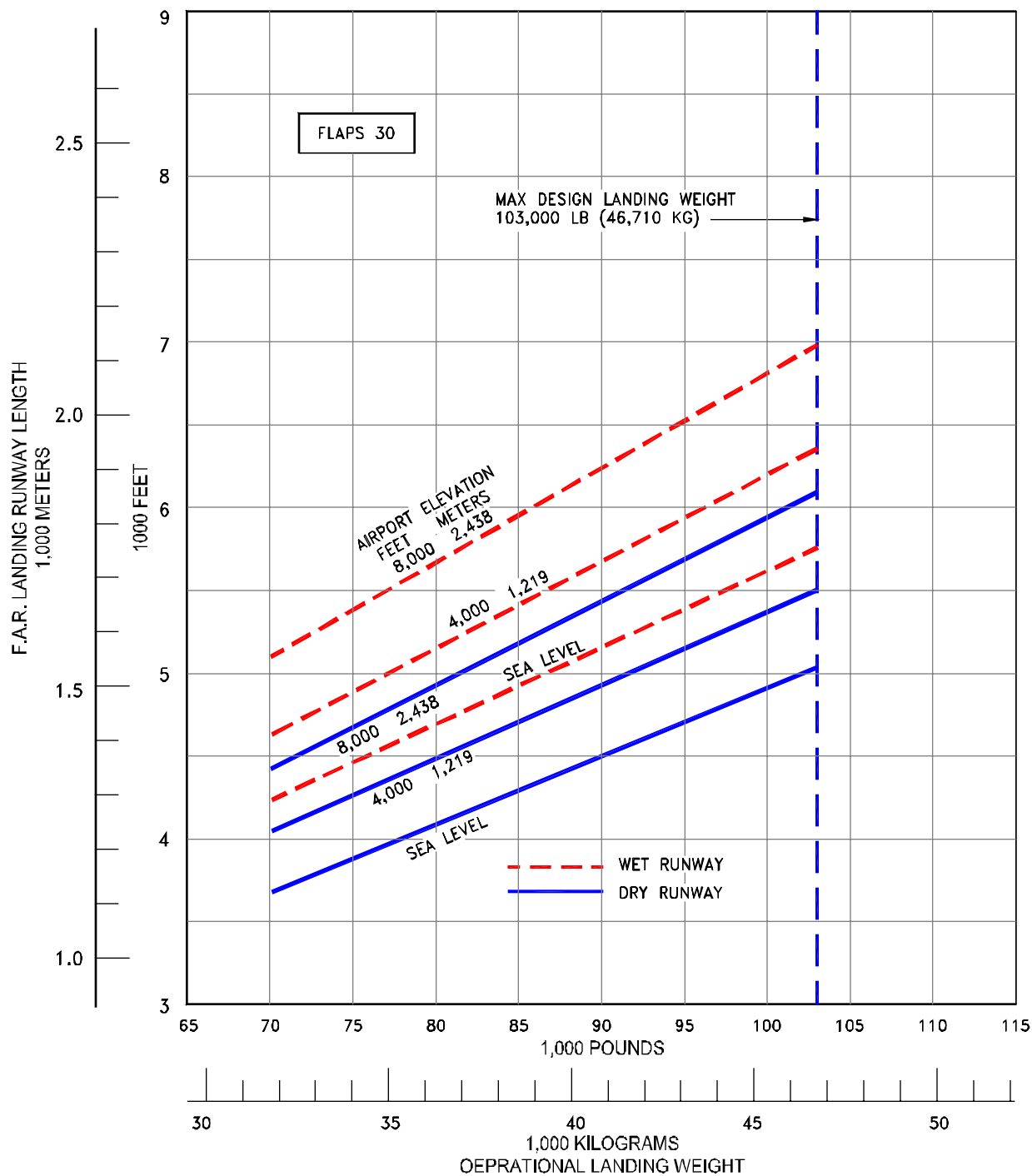

3.4.5 F.A.R. LANDING RUNWAY LENGTH REQUIREMENTS - FLAPS 30
 MODEL 737-200, -200C

NOTES:

- * $V_{APP} = 1.3V_s$
- * ZERO WIND
- * FLAP POSITION 25
- * AUTOMATIC SPEED BRAKES
- * CONSULT WITH USING AIRLINE FOR SPECIFIC PROCEDURE PRIOR TO FACILITY DESIGN

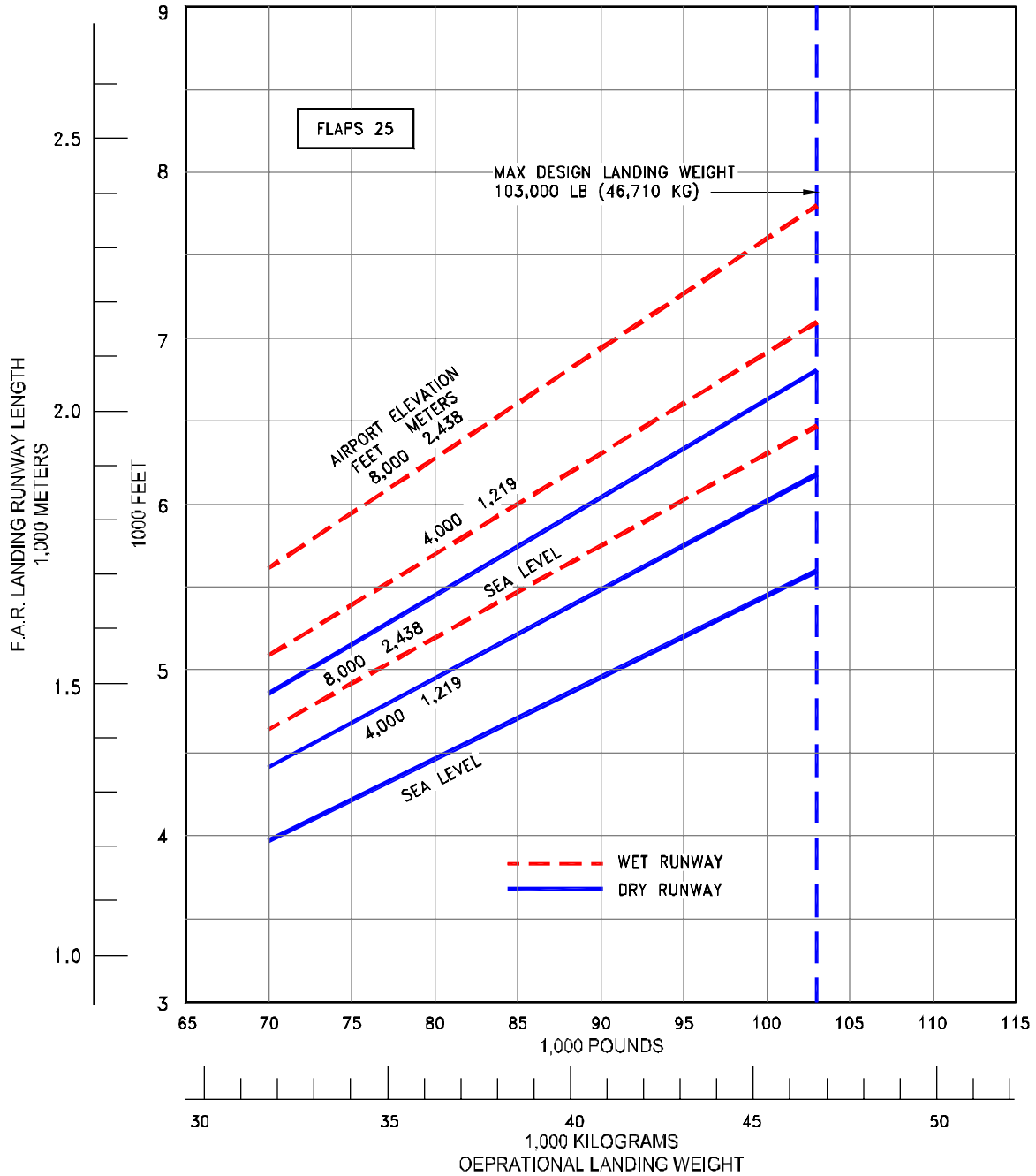

3.4.6 F.A.R. LANDING RUNWAY LENGTH REQUIREMENTS - FLAPS 25
 MODEL 737-200, -200C

NOTES:

- * $V_{APP} = 1.3V_S$
- * ZERO WIND
- * FLAP POSITION 40
- * AUTOMATIC SPEED BRAKES
- * CONSULT WITH USING AIRLINE FOR SPECIFIC PROCEDURE PRIOR TO FACILITY DESIGN

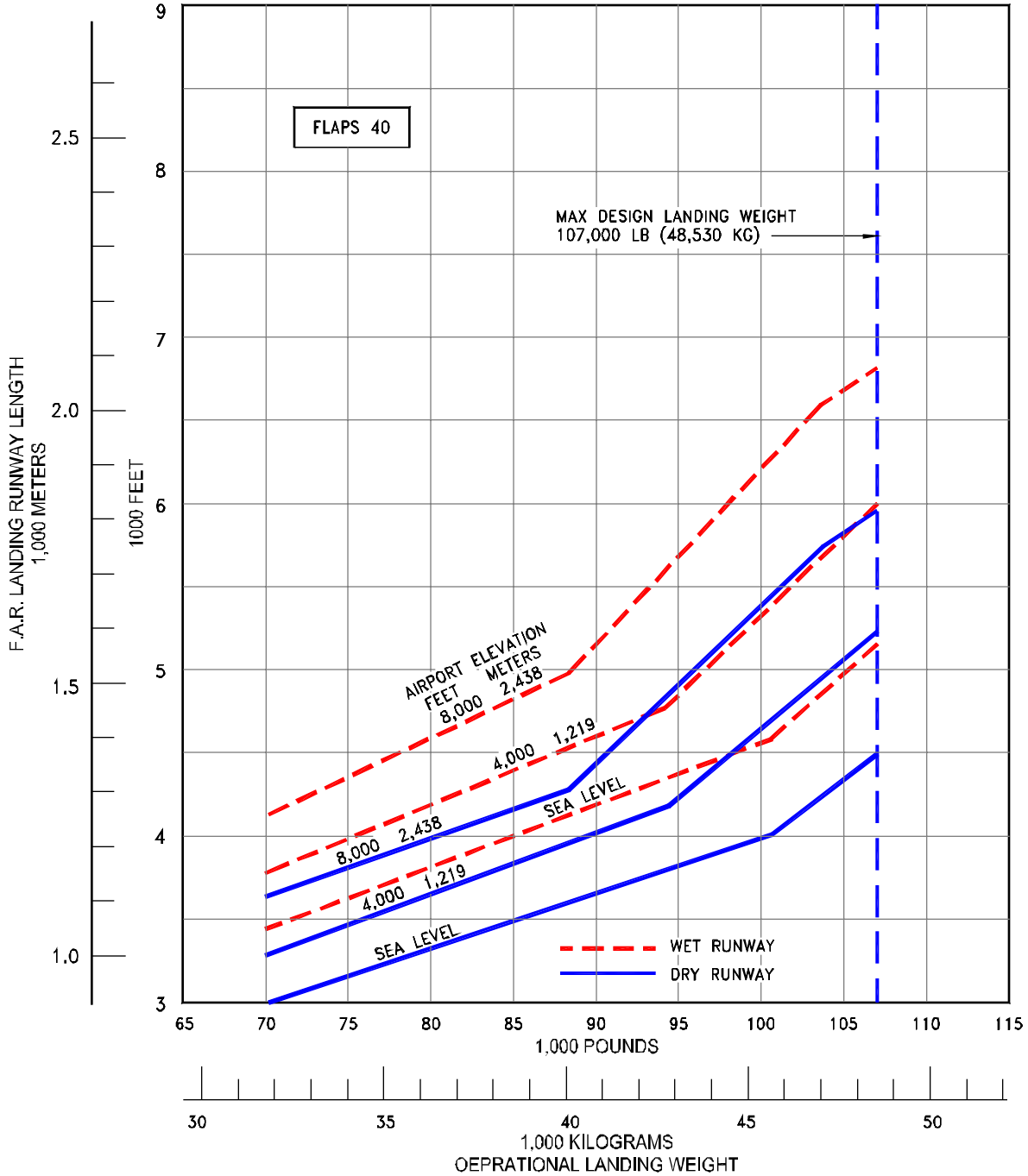

3.4.7 F.A.R. LANDING RUNWAY LENGTH REQUIREMENTS - FLAPS 40
 MODEL ADVANCED 737-200, -200C

NOTES:

- * $V_{APP} = 1.3V_S$
- * ZERO WIND
- * FLAP POSITION 30
- * AUTOMATIC SPEED BRAKES
- * CONSULT WITH USING AIRLINE FOR SPECIFIC PROCEDURE PRIOR TO FACILITY DESIGN

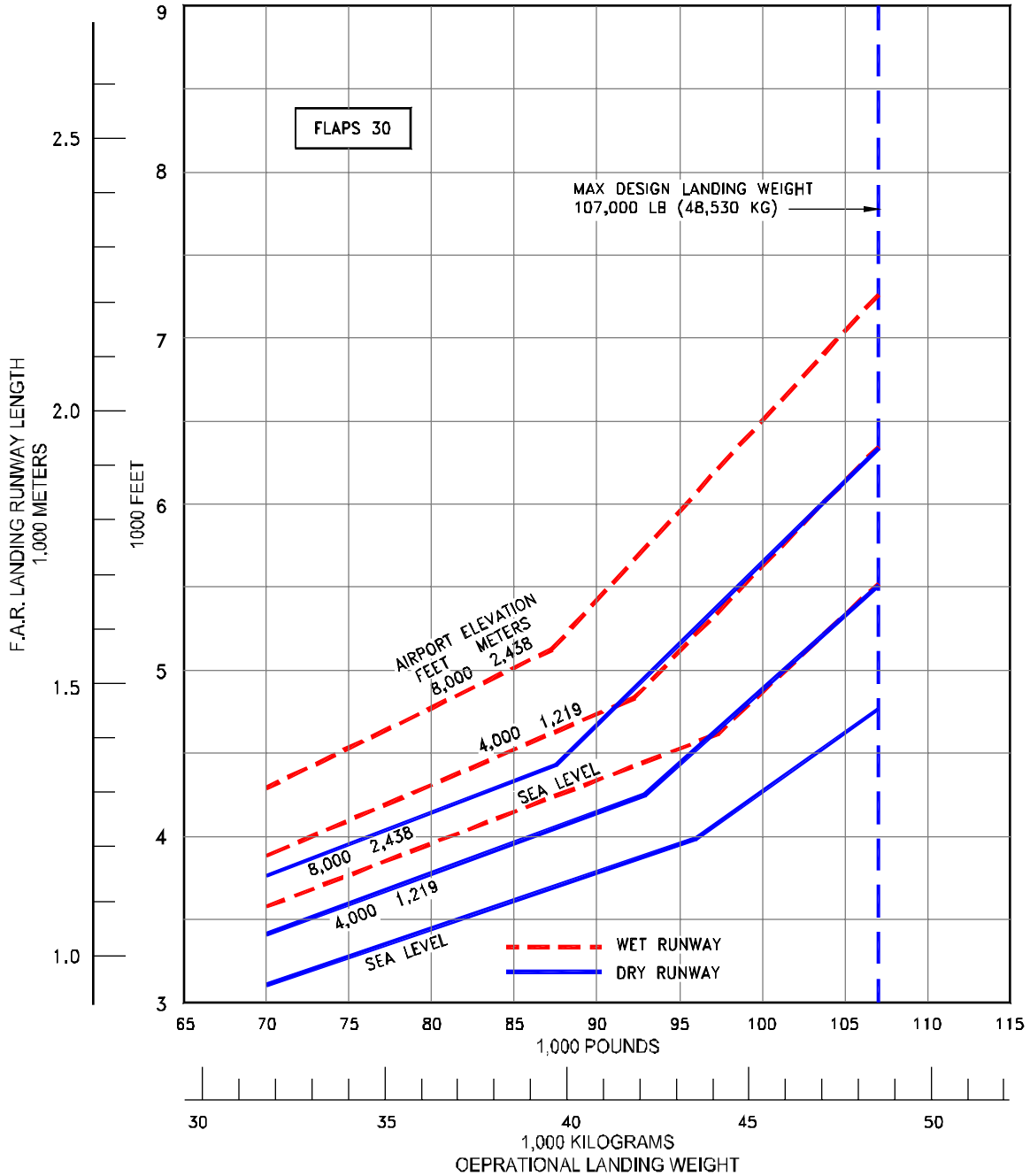

3.4.8 F.A.R. LANDING RUNWAY LENGTH REQUIREMENTS - FLAPS 30
MODEL 737-ADVANCED 737-200, -200C

- NOTES:
- * $V_{APP} = 1.3V_S$
 - * ZERO WIND
 - * FLAP POSITION 25
 - * AUTOMATIC SPEED BRAKES
 - * CONSULT WITH USING AIRLINE FOR SPECIFIC PROCEDURE PRIOR TO FACILITY DESIGN

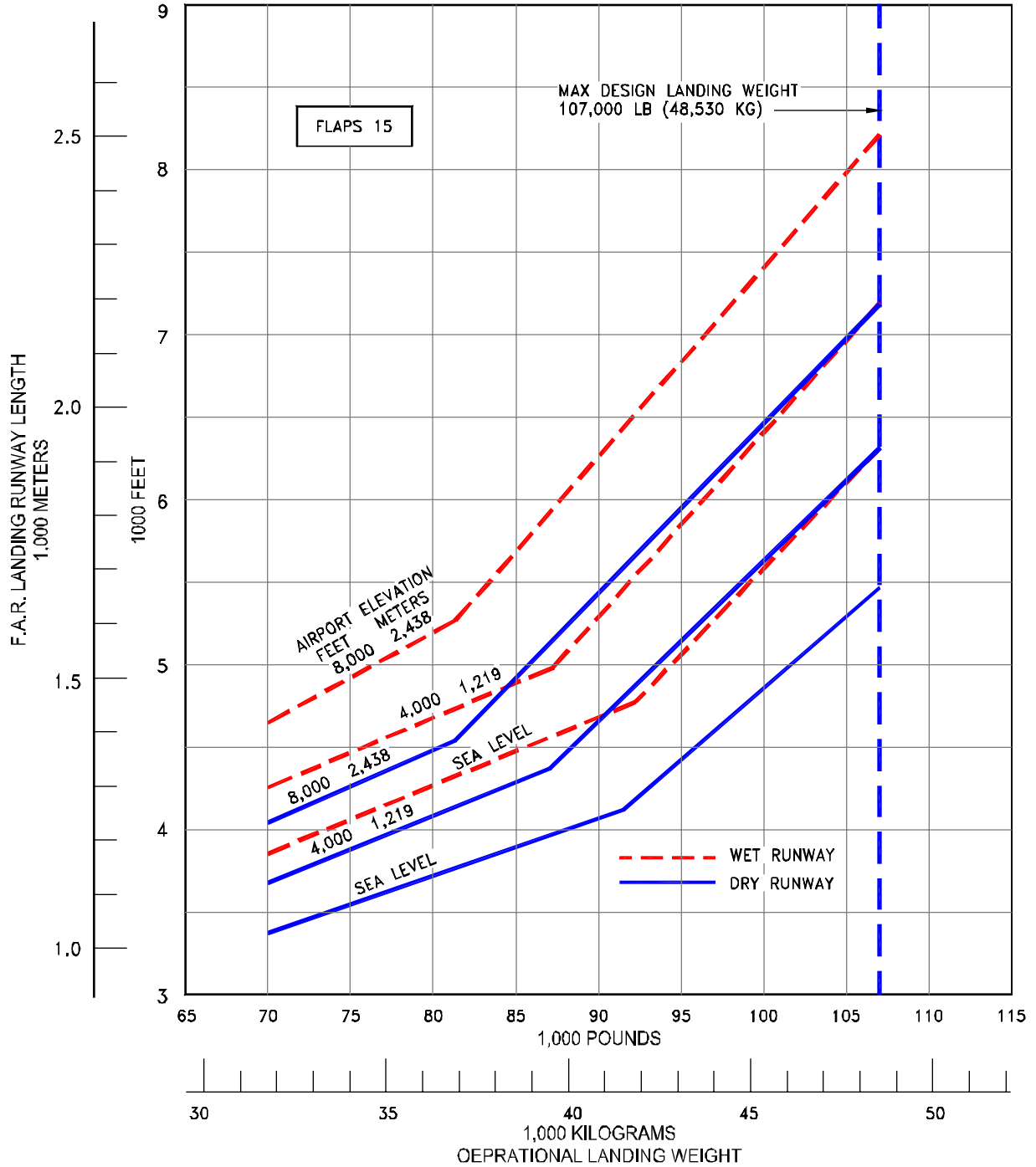

3.4.9 F.A.R. LANDING RUNWAY LENGTH REQUIREMENTS - FLAPS 15
 MODEL ADVANCED 737-200, -200C

NOTES:

- * $V_{APP} = 1.3V_S$
- * ZERO WIND, ZERO RUNWAY GRADIENT
- * FLAP POSITION 40
- * AUTOMATIC SPEED BRAKES
- * CONSULT WITH USING AIRLINE FOR SPECIFIC PROCEDURE PRIOR TO FACILITY DESIGN

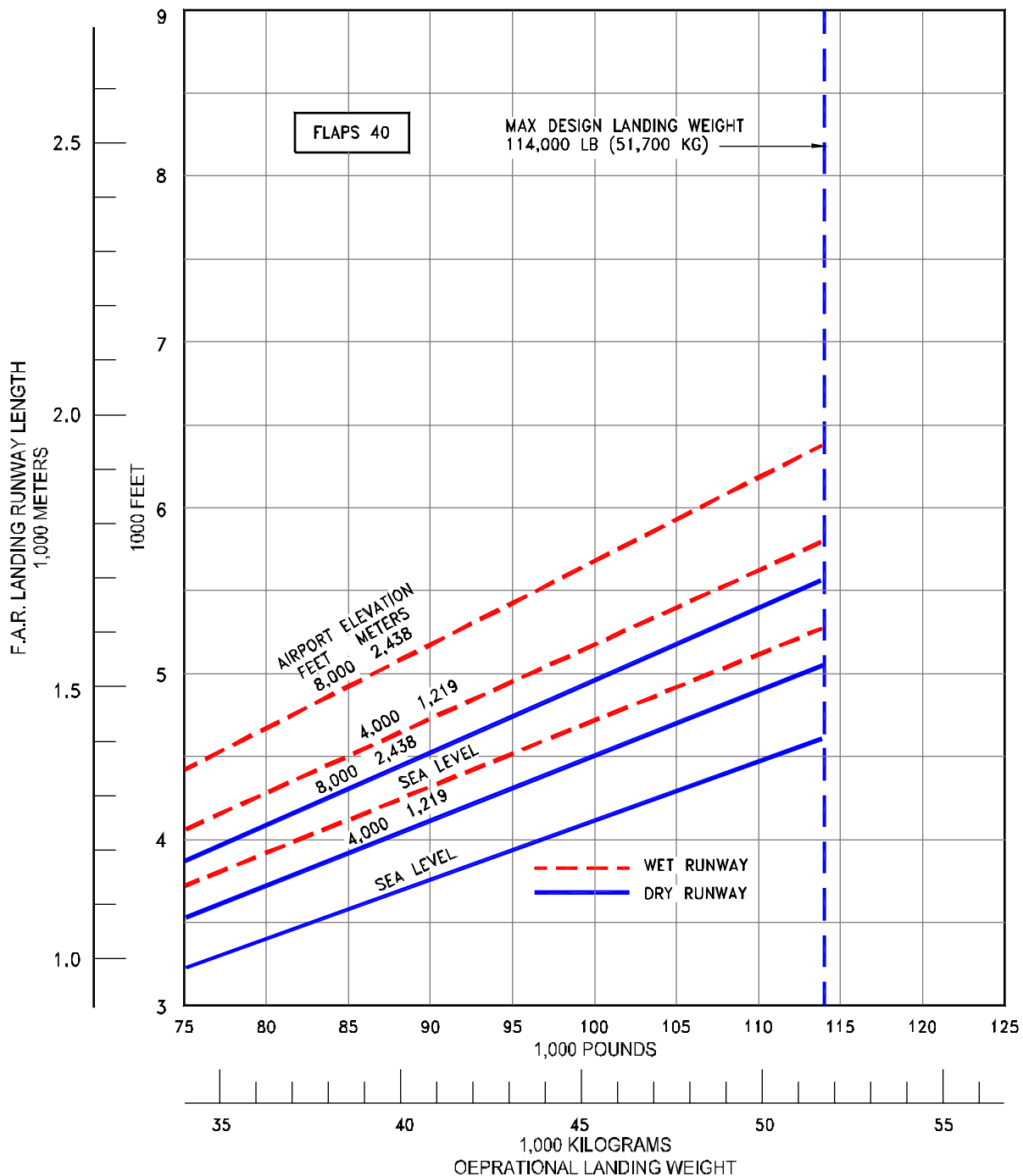

3.4.10 F.A.R. LANDING RUNWAY LENGTH REQUIREMENTS - FLAPS 40
 MODEL 737-300

NOTES:

- * $V_{APP} = 1.3V_S$
- * ZERO WIND, ZERO RUNWAY GRADIENT
- * FLAP POSITION 30
- * AUTOMATIC SPEED BRAKES
- * CONSULT WITH USING AIRLINE FOR SPECIFIC PROCEDURE PRIOR TO FACILITY DESIGN

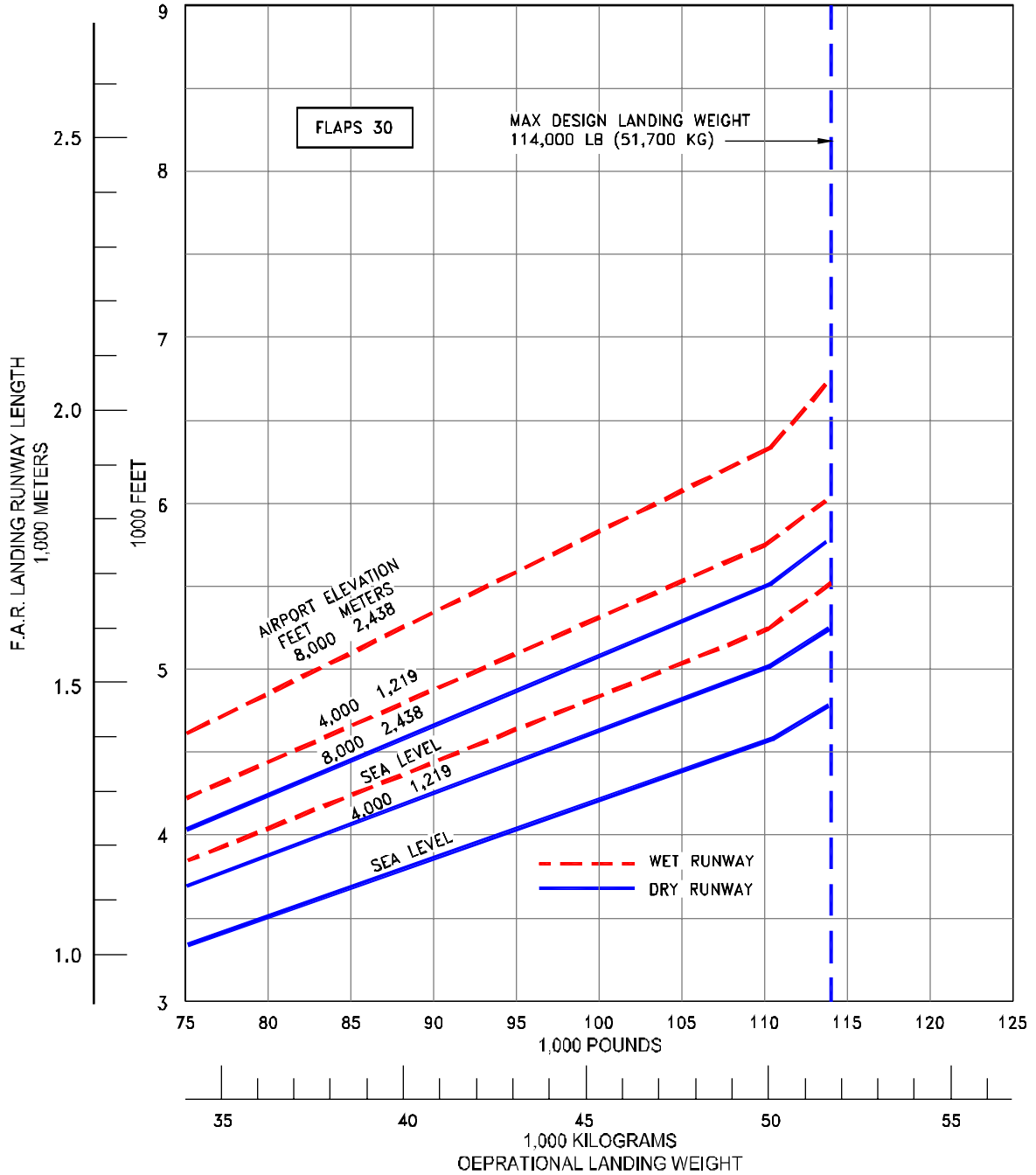

3.4.11 F.A.R. LANDING RUNWAY LENGTH REQUIREMENTS - FLAPS 30
 MODEL 737-600

NOTES:

- * $V_{APP} = 1.3V_S$
- * ZERO WIND, ZERO RUNWAY GRADIENT
- * FLAP POSITION 15
- * AUTOMATIC SPEED BRAKES
- * CONSULT WITH USING AIRLINE FOR SPECIFIC PROCEDURE PRIOR TO FACILITY DESIGN

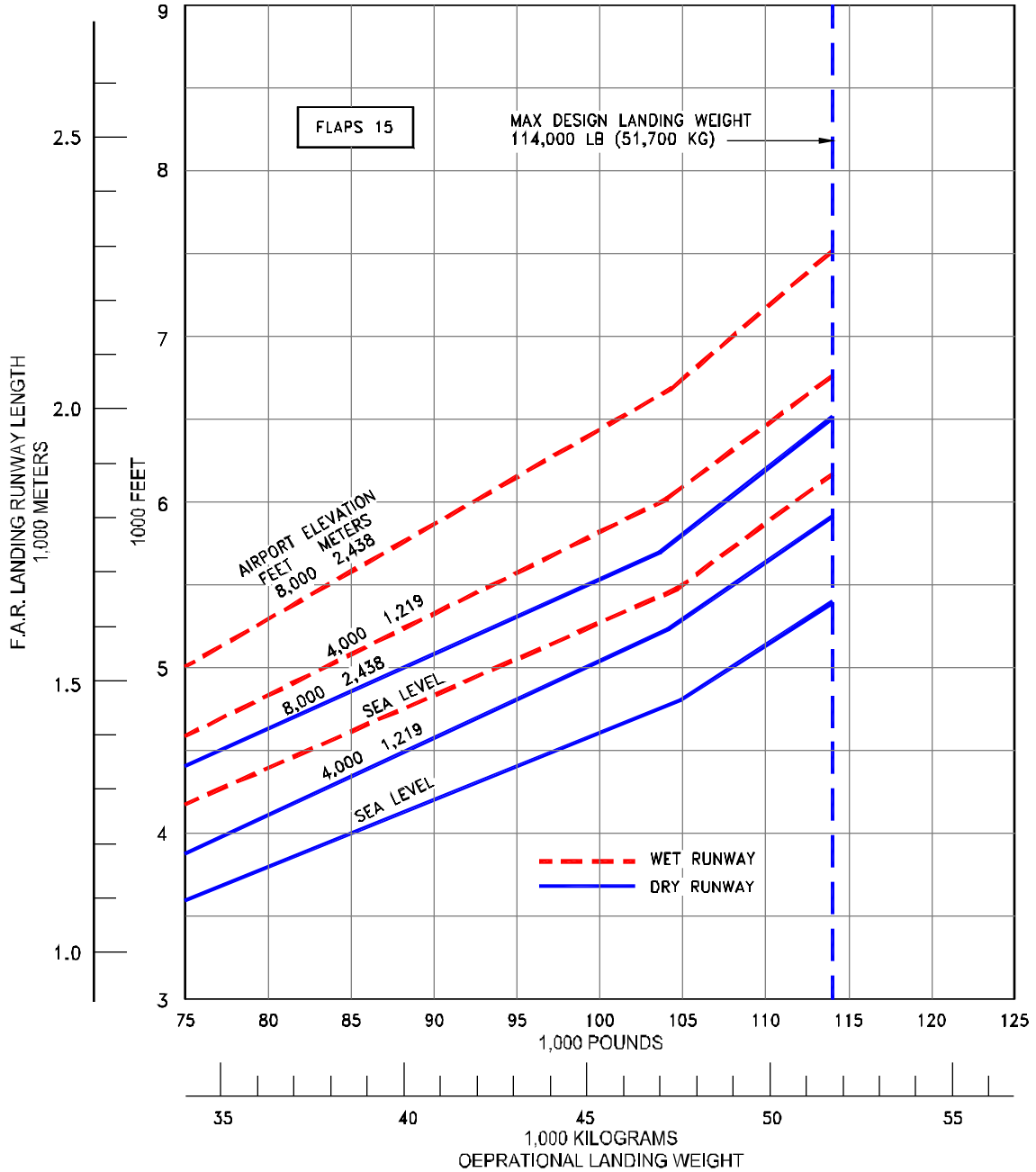

3.4.12 F.A.R. LANDING RUNWAY LENGTH REQUIREMENTS - FLAPS 15
 MODEL 737-300

NOTES:

- * $V_{APP} = 1.3V_S$
- * ZERO WIND, ZERO RUNWAY GRADIENT
- * FLAP POSITION 40
- * AUTOMATIC SPEED BRAKES
- * CONSULT WITH USING AIRLINE FOR SPECIFIC PROCEDURE PRIOR TO FACILITY DESIGN

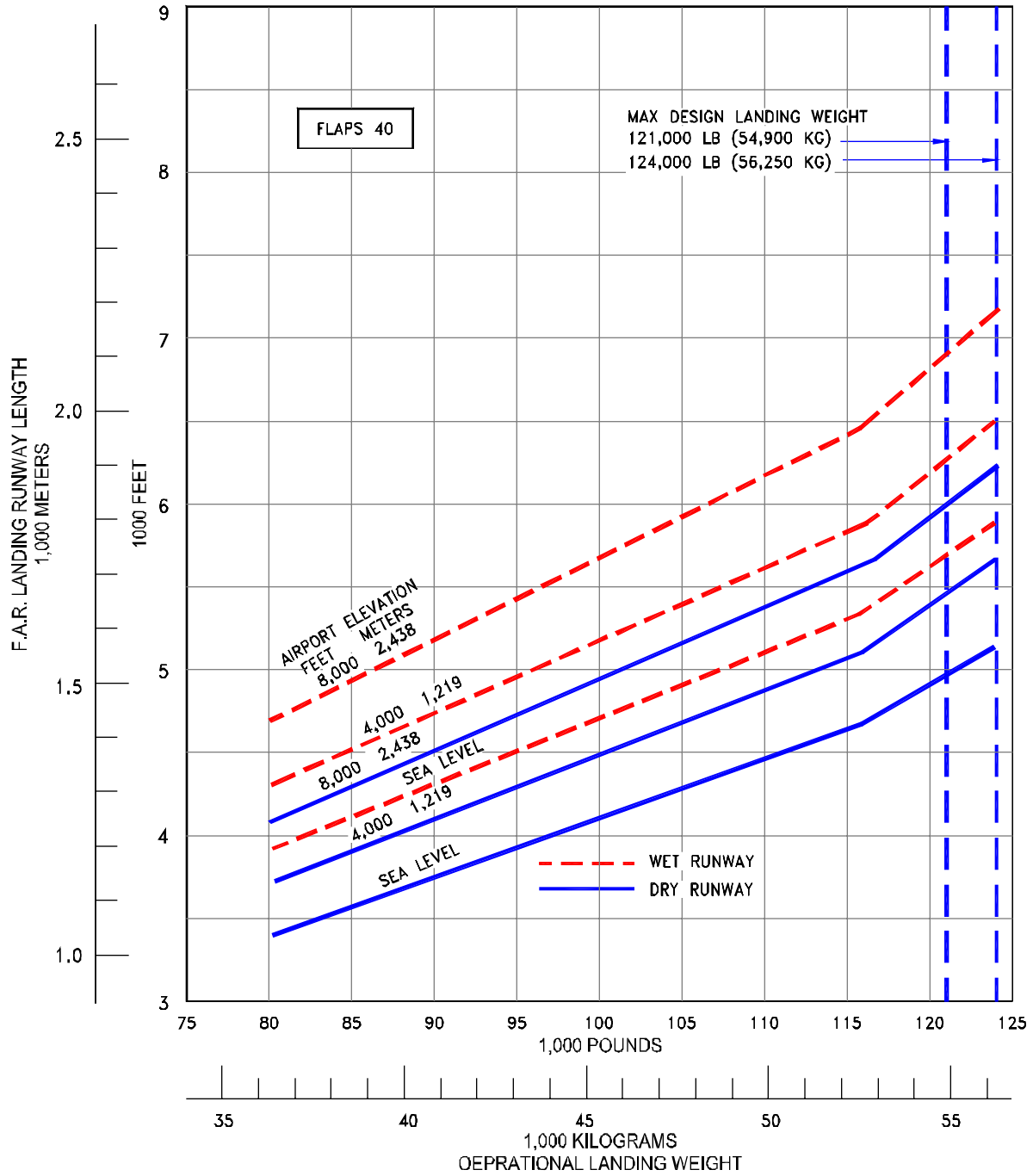

3.4.13 F.A.R. LANDING RUNWAY LENGTH REQUIREMENTS - FLAPS 40
 MODEL 737-400

NOTES:

- * $V_{APP} = 1.3V_S$
- * ZERO WIND, ZERO RUNWAY GRADIENT
- * FLAP POSITION 30
- * AUTOMATIC SPEED BRAKES
- * CONSULT WITH USING AIRLINE FOR SPECIFIC PROCEDURE PRIOR TO FACILITY DESIGN

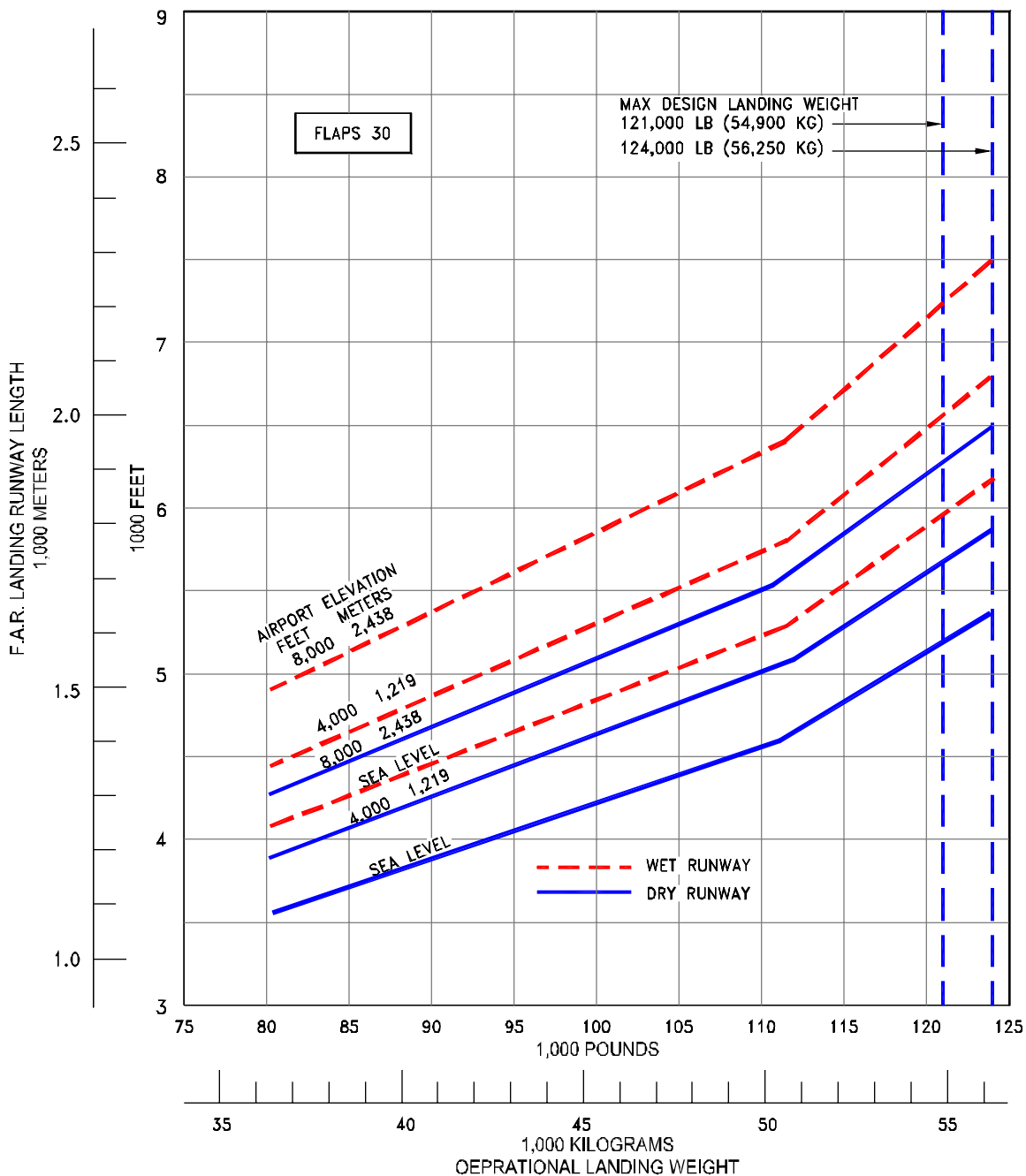

3.4.14 F.A.R. LANDING RUNWAY LENGTH REQUIREMENTS - FLAPS 30
 MODEL 737-400

NOTES:

- * $V_{APP} = 1.3V_S$
- * ZERO WIND, ZERO RUNWAY GRADIENT
- * FLAP POSITION 15
- * AUTOMATIC SPEED BRAKES
- * CONSULT WITH USING AIRLINE FOR SPECIFIC PROCEDURE PRIOR TO FACILITY DESIGN

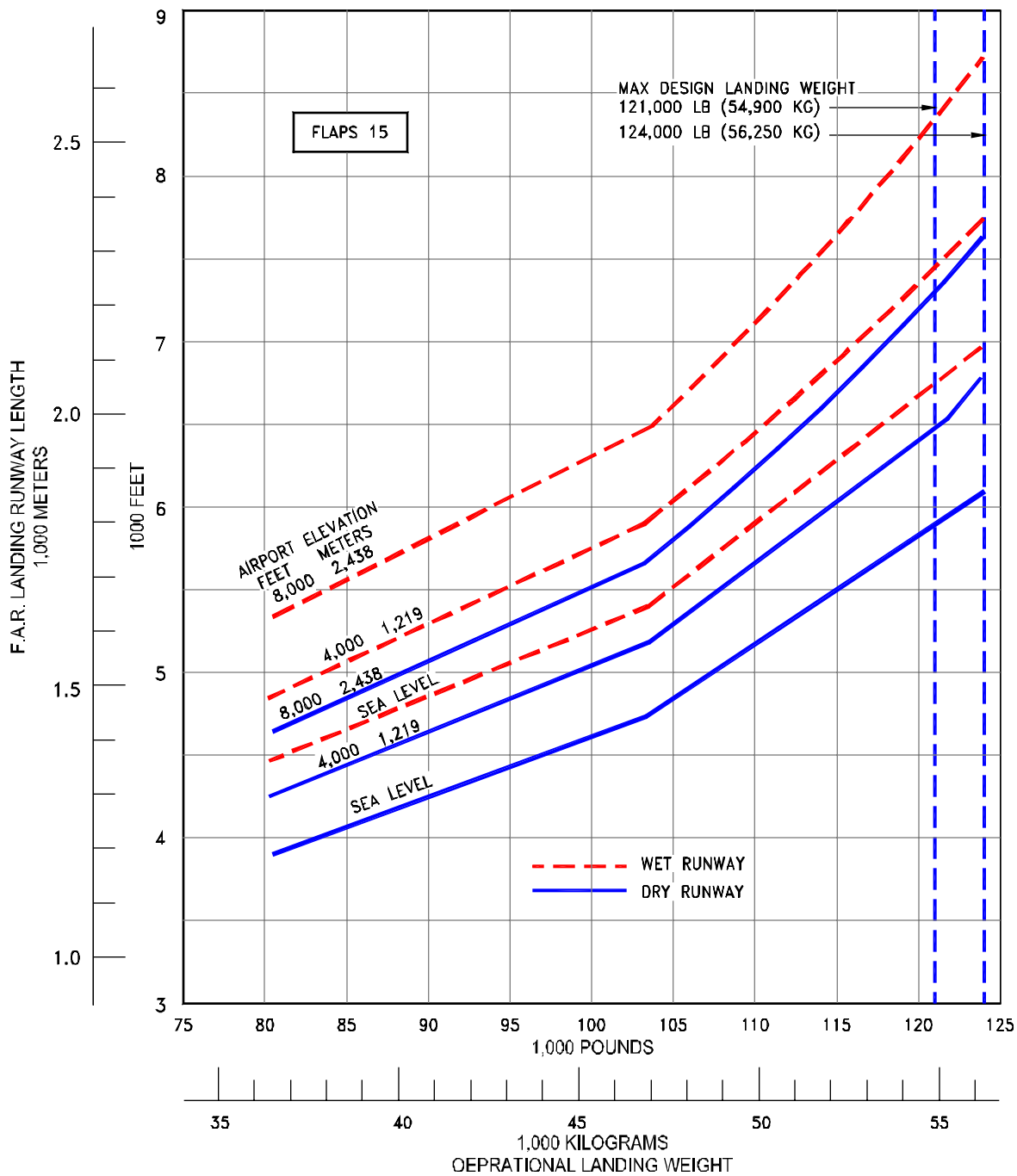

3.4.15 F.A.R. LANDING RUNWAY LENGTH REQUIREMENTS - FLAPS 15
 MODEL 737-400

D6-58325-6

NOTES:

- * $V_{APP} = 1.3V_s$
- * ZERO WIND, ZERO RUNWAY GRADIENT
- * FLAP POSITION 40
- * AUTOMATIC SPEED BRAKES
- * CONSULT WITH USING AIRLINE FOR SPECIFIC PROCEDURE PRIOR TO FACILITY DESIGN

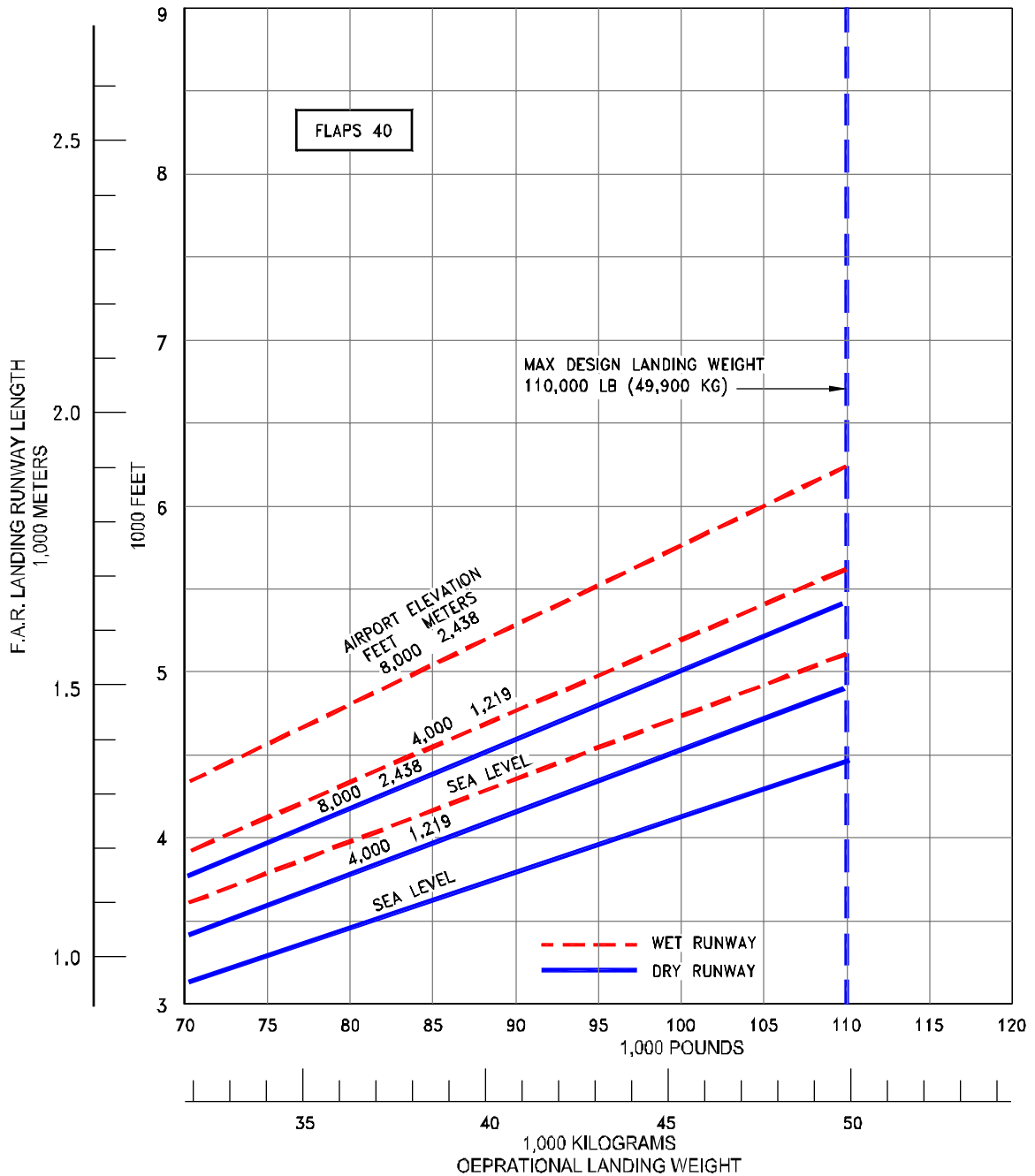

3.4.16 F.A.R. LANDING RUNWAY LENGTH REQUIREMENTS - FLAPS 40
 MODEL 737-500

NOTES:

- * $V_{APP} = 1.3V_S$
- * ZERO WIND, ZERO RUNWAY GRADIENT
- * FLAP POSITION 30
- * AUTOMATIC SPEED BRAKES
- * CONSULT WITH USING AIRLINE FOR SPECIFIC PROCEDURE PRIOR TO FACILITY DESIGN

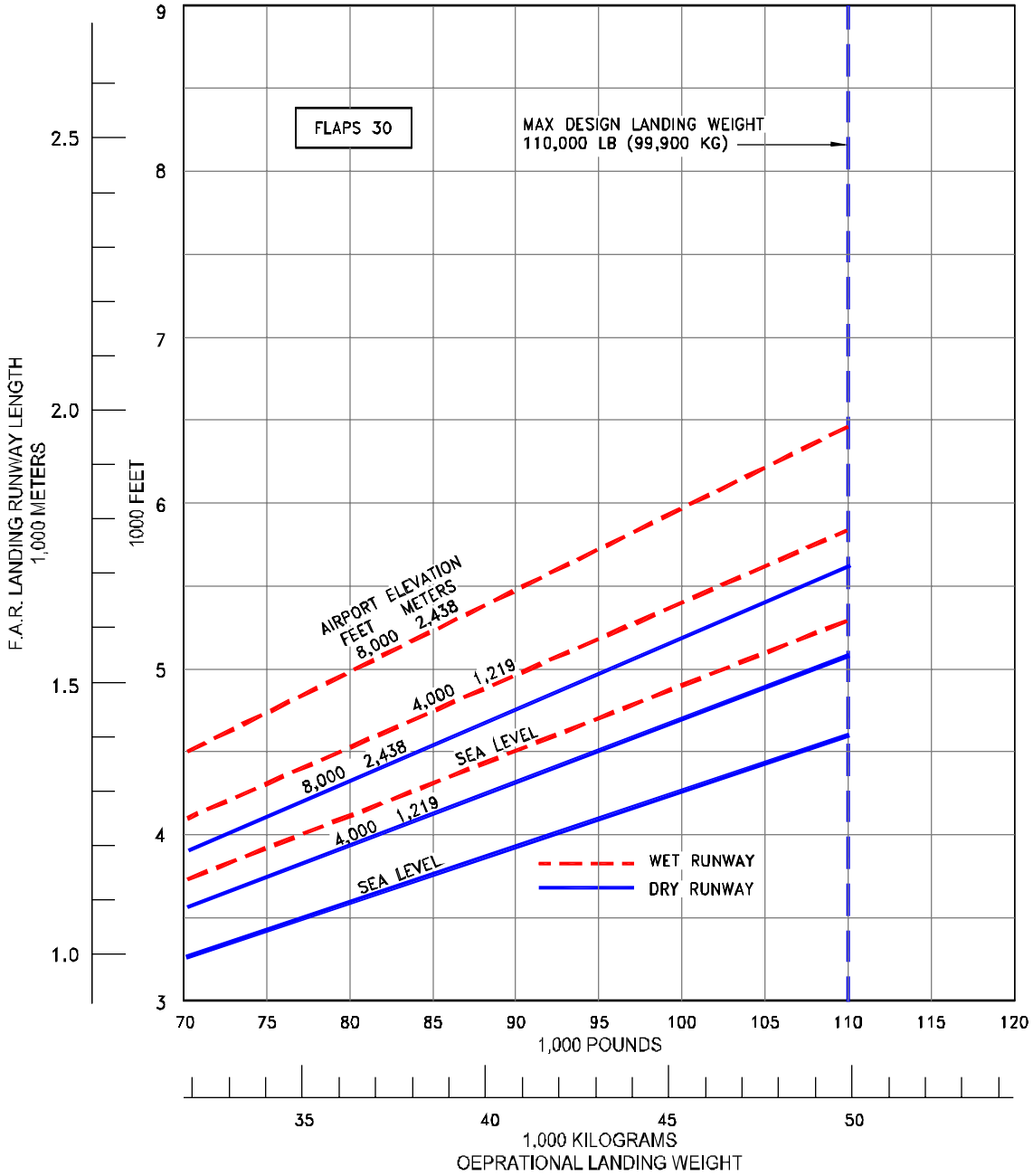

3.4.17 F.A.R. LANDING RUNWAY LENGTH REQUIREMENTS - FLAPS 30
 MODEL 737-500

NOTES:

- * $V_{APP} = 1.3V_S$
- * ZERO WIND, ZERO RUNWAY GRADIENT
- * FLAP POSITION 15
- * AUTOMATIC SPEED BRAKES
- * CONSULT WITH USING AIRLINE FOR SPECIFIC PROCEDURE PRIOR TO FACILITY DESIGN

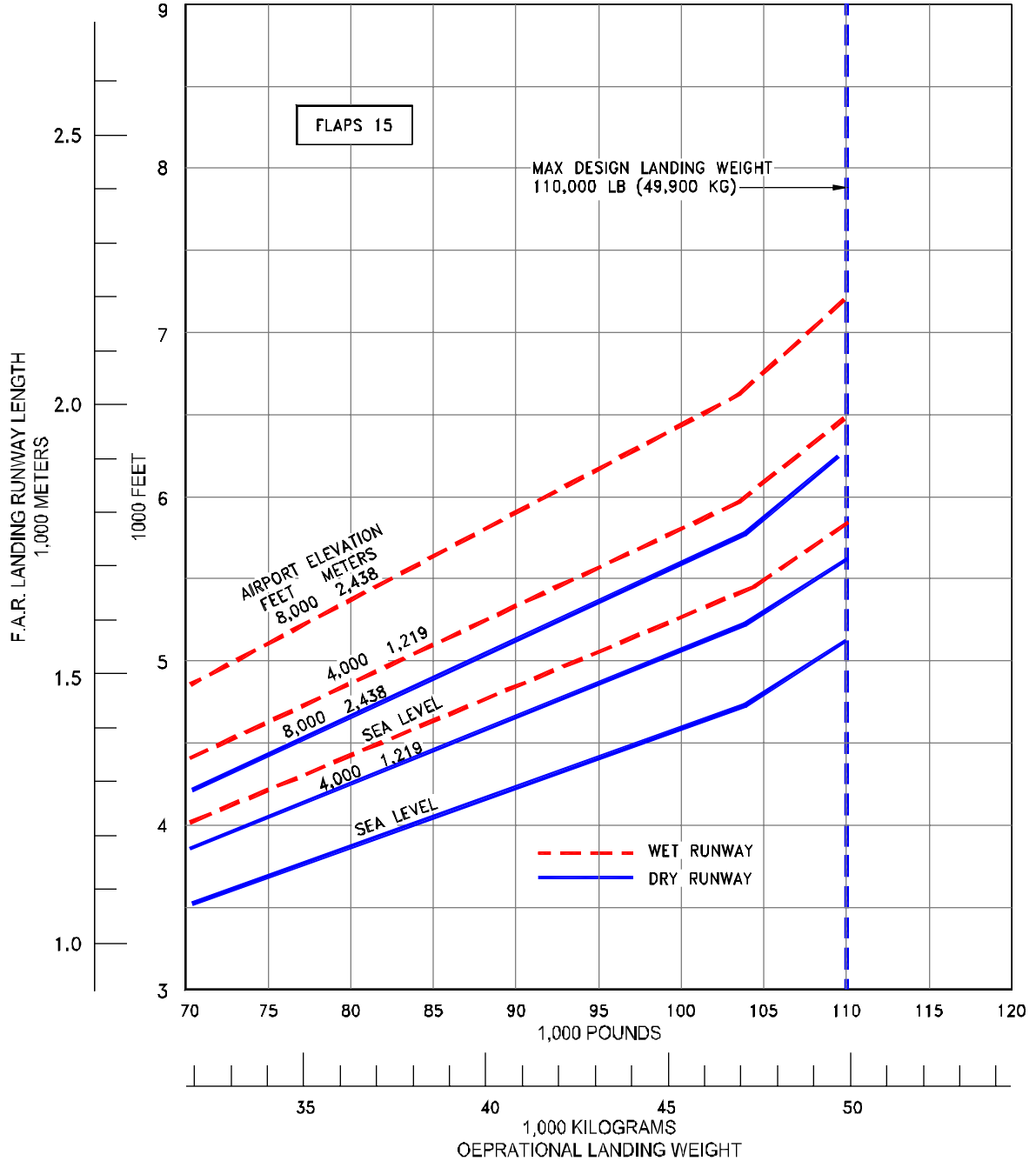

3.4.18 F.A.R. LANDING RUNWAY LENGTH REQUIREMENTS - FLAPS 15

MODEL 737-500

NOTES:

- STANDARD DAY
- AUTO SPOILERS OPERATIVE
- ANTI-SKID OPERATIVE
- ZERO WIND
- CONSULT USING AIRLINE FOR SPECIFIC OPERATING PROCEDURE PRIOR TO FACILITY DESIGN

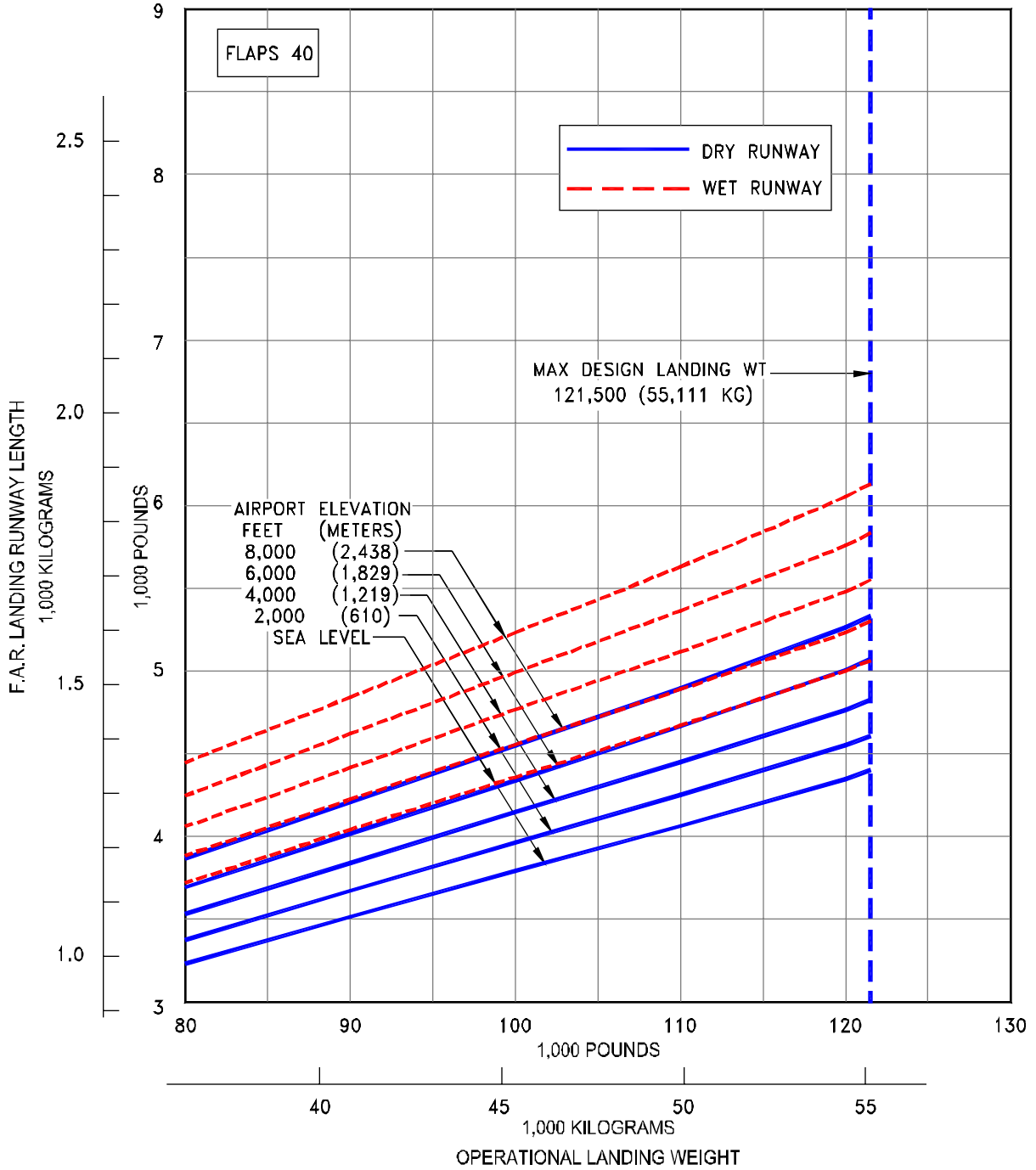

3.4.19 F.A.R. LANDING RUNWAY LENGTH REQUIREMENTS - FLAPS 40
 MODEL 737-600

NOTES:

- STANDARD DAY
- AUTO SPOILERS OPERATIVE
- ANTI-SKID OPERATIVE
- ZERO WIND
- CONSULT USING AIRLINE FOR SPECIFIC OPERATING PROCEDURE PRIOR TO FACILITY DESIGN

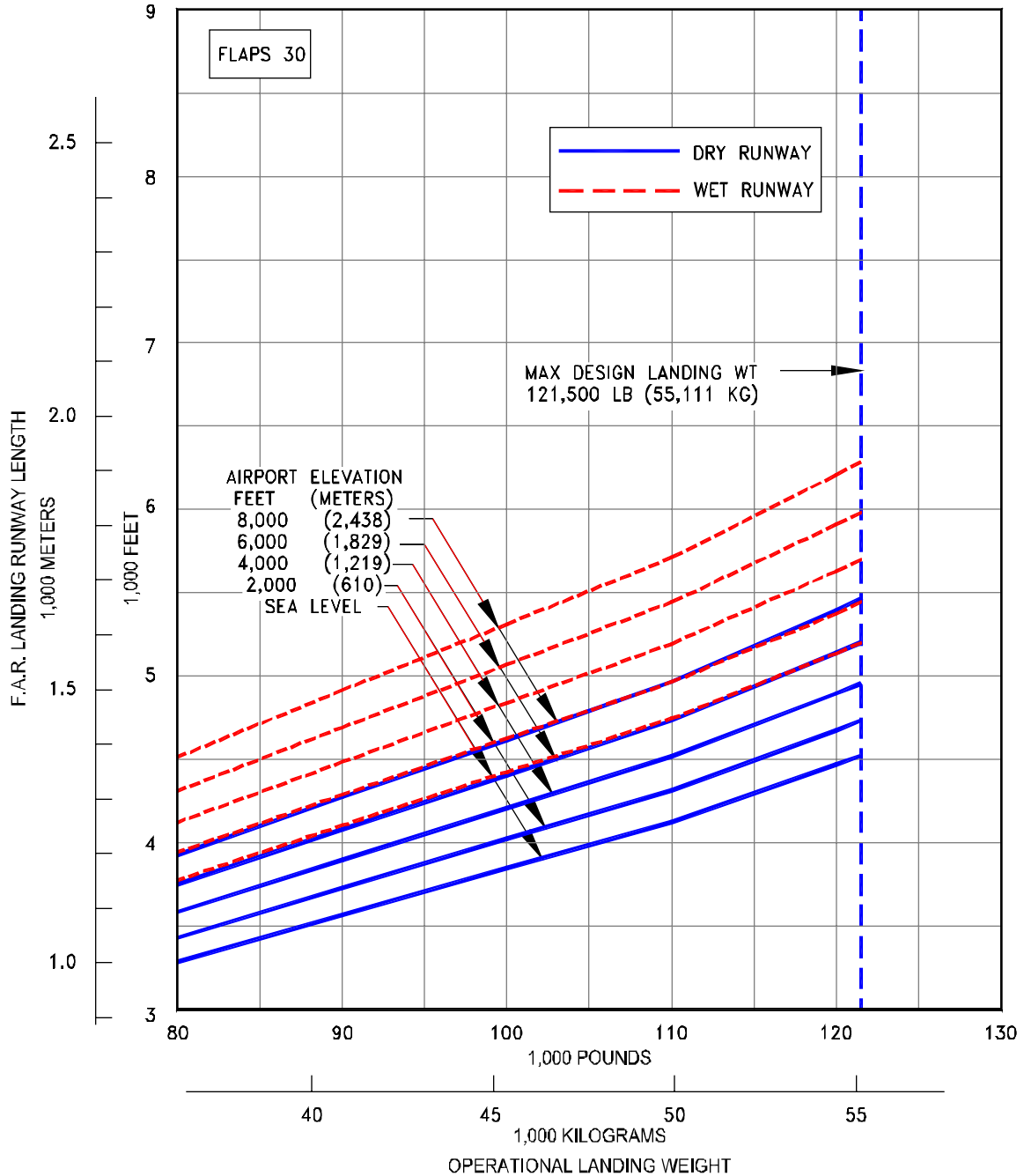

3.4.20 F.A.R. LANDING RUNWAY LENGTH REQUIREMENTS - FLAPS 30
 MODEL 737-600

NOTES:

- STANDARD DAY
- AUTO SPOILERS OPERATIVE
- ANTI-SKID OPERATIVE
- ZERO WIND
- CONSULT USING AIRLINE FOR SPECIFIC OPERATING PROCEDURE PRIOR TO FACILITY DESIGN

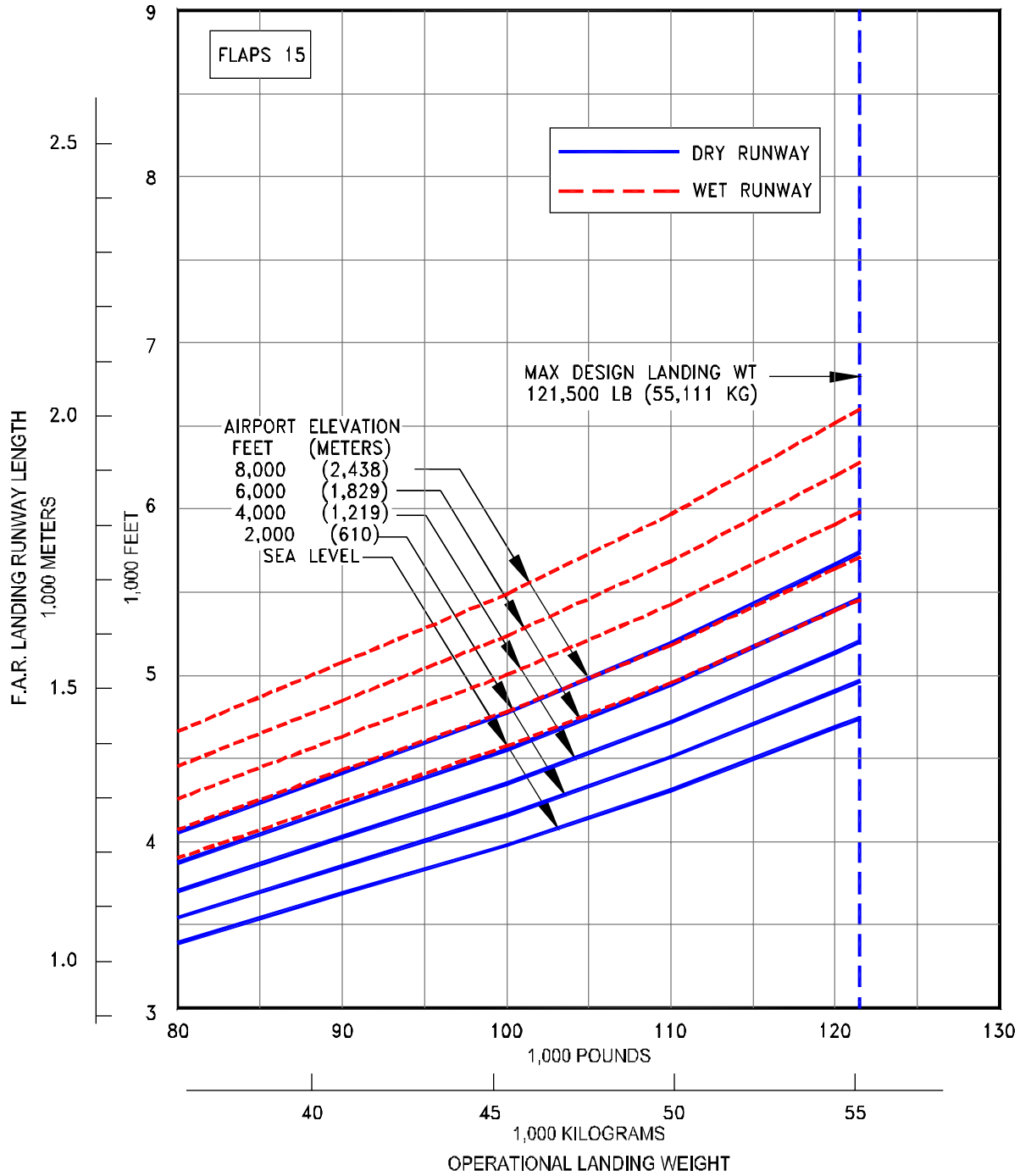

3.4.21 F.A.R. LANDING RUNWAY LENGTH REQUIREMENTS - FLAPS 15
 MODEL 737-600

NOTES:

- STANDARD DAY
- AUTO SPOILERS OPERATIVE
- ANTI-SKID OPERATIVE
- ZERO WIND
- CONSULT USING AIRLINE FOR SPECIFIC OPERATING PROCEDURE PRIOR TO FACILITY DESIGN

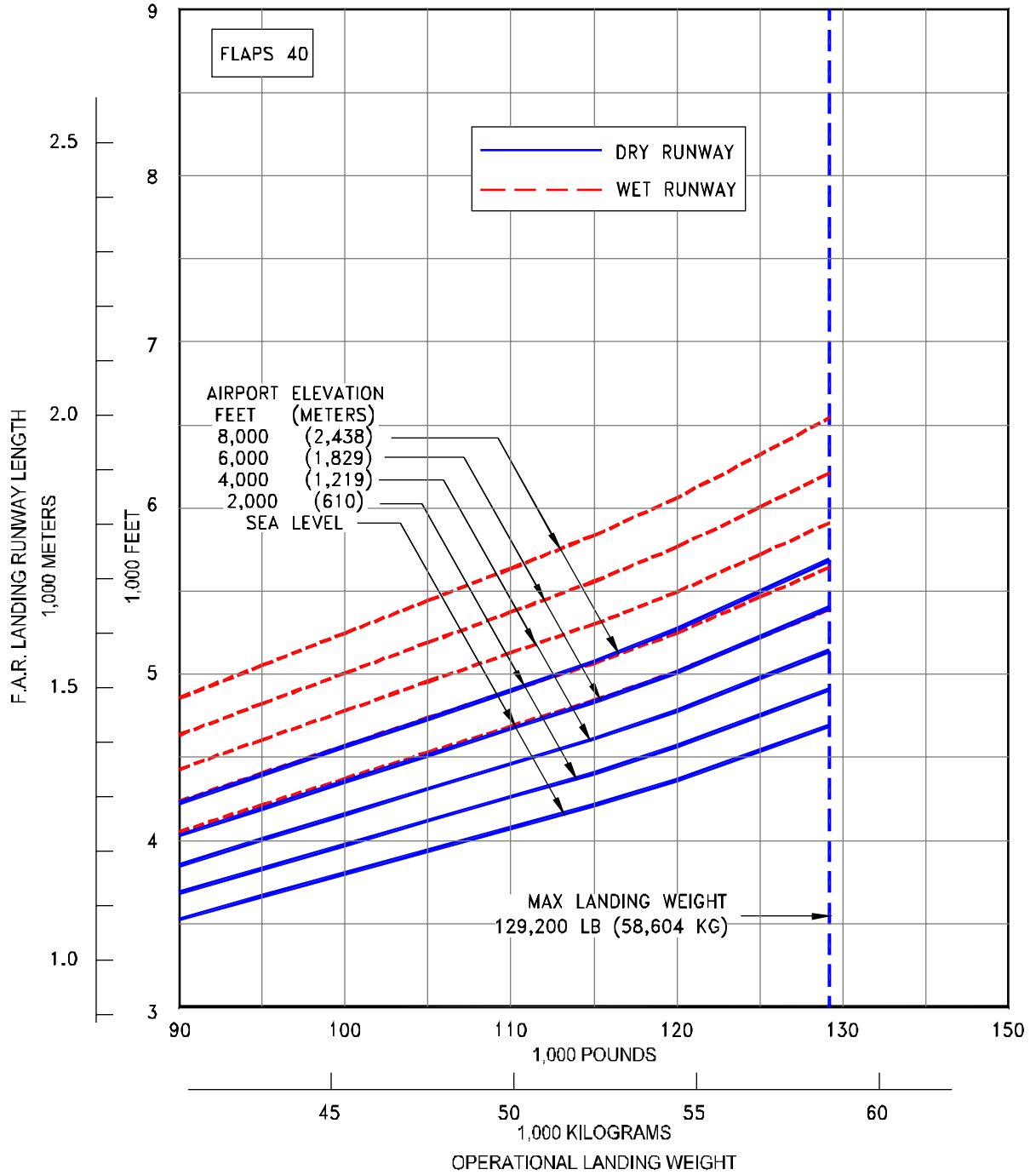

3.4.22 F.A.R. LANDING RUNWAY LENGTH REQUIREMENTS - FLAPS 40
MODEL 737-700

NOTES:

- STANDARD DAY
- AUTO SPOILERS OPERATIVE
- ANTI-SKID OPERATIVE
- ZERO WIND
- CONSULT USING AIRLINE FOR SPECIFIC OPERATING PROCEDURE PRIOR TO FACILITY DESIGN

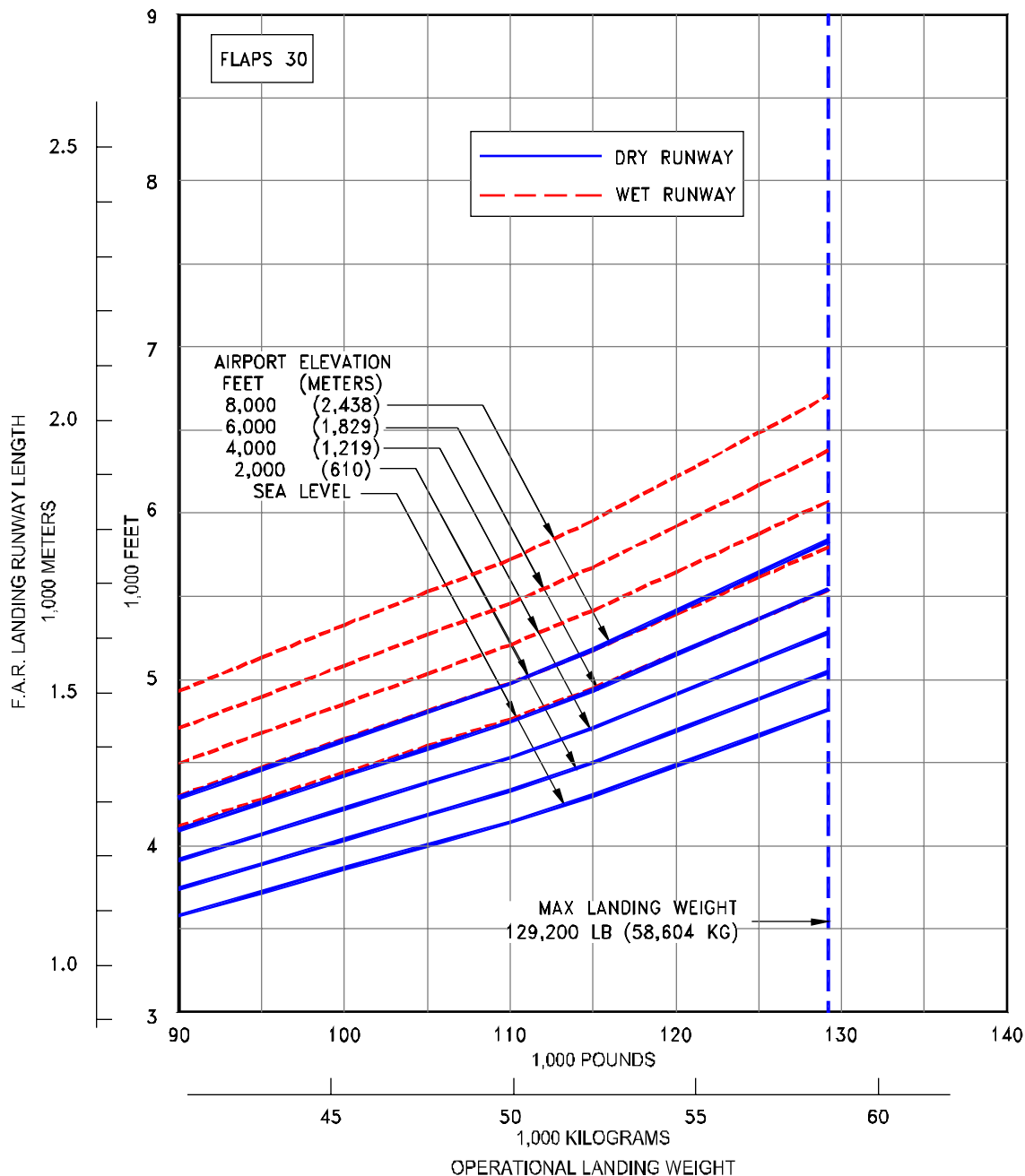

3.4.23 F.A.R. LANDING RUNWAY LENGTH REQUIREMENTS - FLAPS 30
 MODEL 737-700

NOTES:

- STANDARD DAY
- AUTO SPOILERS OPERATIVE
- ANTI-SKID OPERATIVE
- ZERO WIND
- CONSULT USING AIRLINE FOR SPECIFIC OPERATING PROCEDURE PRIOR TO FACILITY DESIGN

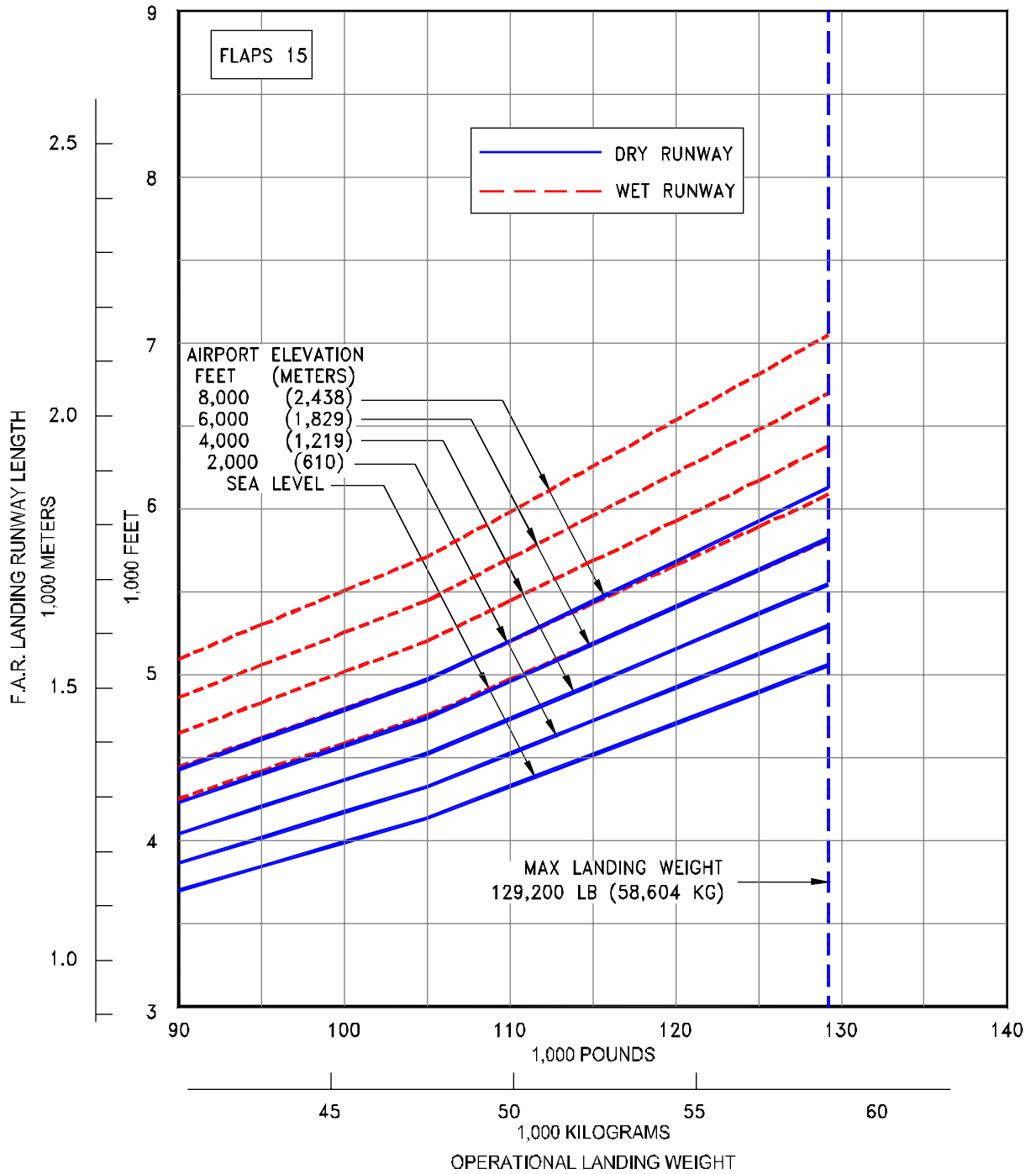

3.4.24 F.A.R. LANDING RUNWAY LENGTH REQUIREMENTS - FLAPS 15
 MODEL 737-700

NOTES:

- STANDARD DAY
- AUTO SPOILERS OPERATIVE
- ANTI-SKID OPERATIVE
- ZERO WIND
- CONSULT USING AIRLINE FOR SPECIFIC OPERATING PROCEDURE PRIOR TO FACILITY DESIGN

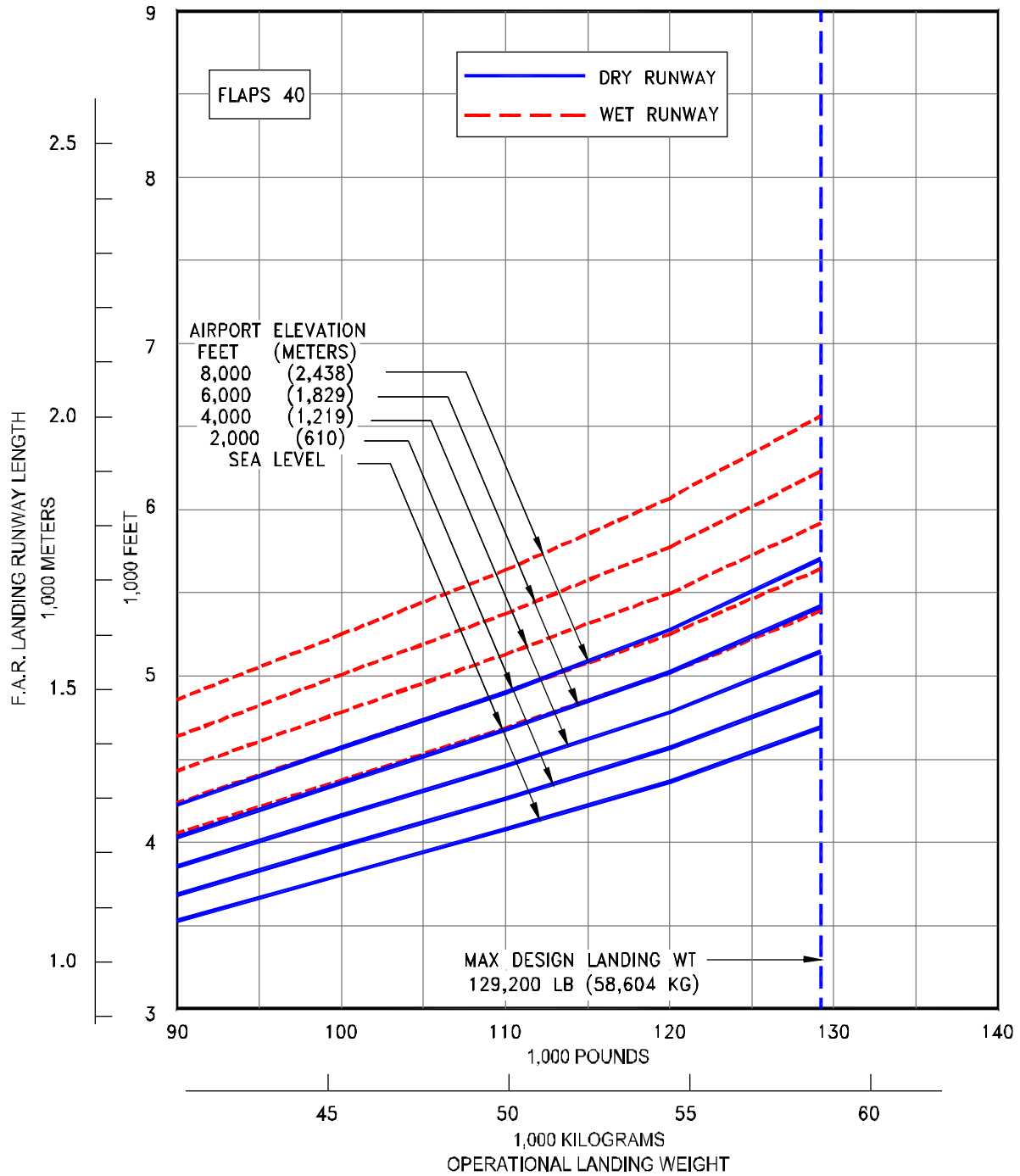

3.4.25 F.A.R. LANDING RUNWAY LENGTH REQUIREMENTS - FLAPS 40
 MODEL 737-700 WITH WINGLETS

NOTES:

- STANDARD DAY
- AUTO SPOILERS OPERATIVE
- ANTI-SKID OPERATIVE
- ZERO WIND
- CONSULT USING AIRLINE FOR SPECIFIC OPERATING PROCEDURE PRIOR TO FACILITY DESIGN

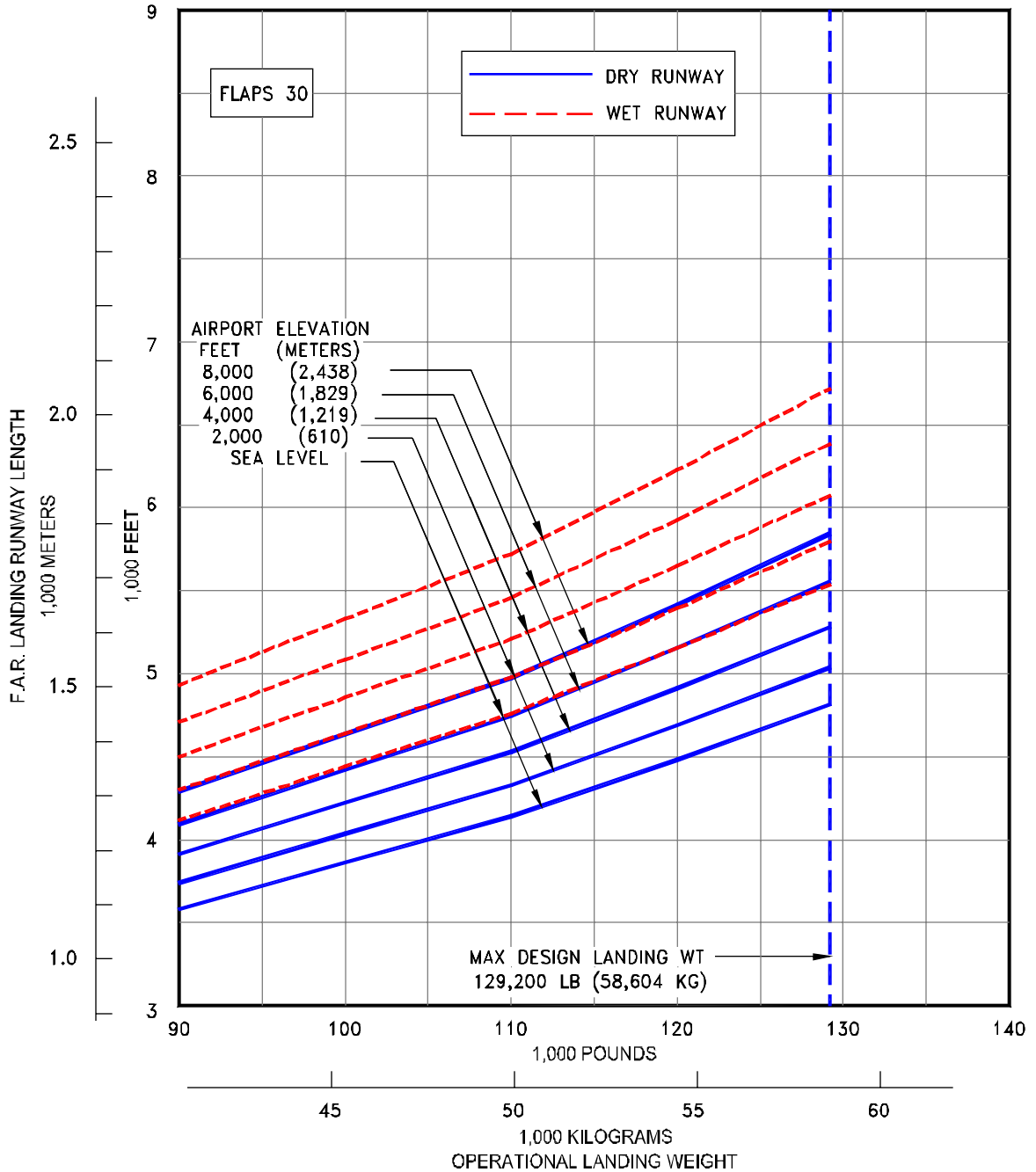

3.4.26 F.A.R. LANDING RUNWAY LENGTH REQUIREMENTS - FLAPS 30
 MODEL 737-700 WITH WINGLETS

- NOTES:
- STANDARD DAY
 - AUTO SPOILERS OPERATIVE
 - ANTI-SKID OPERATIVE
 - ZERO WIND
 - CONSULT USING AIRLINE FOR SPECIFIC OPERATING PROCEDURE PRIOR TO FACILITY DESIGN

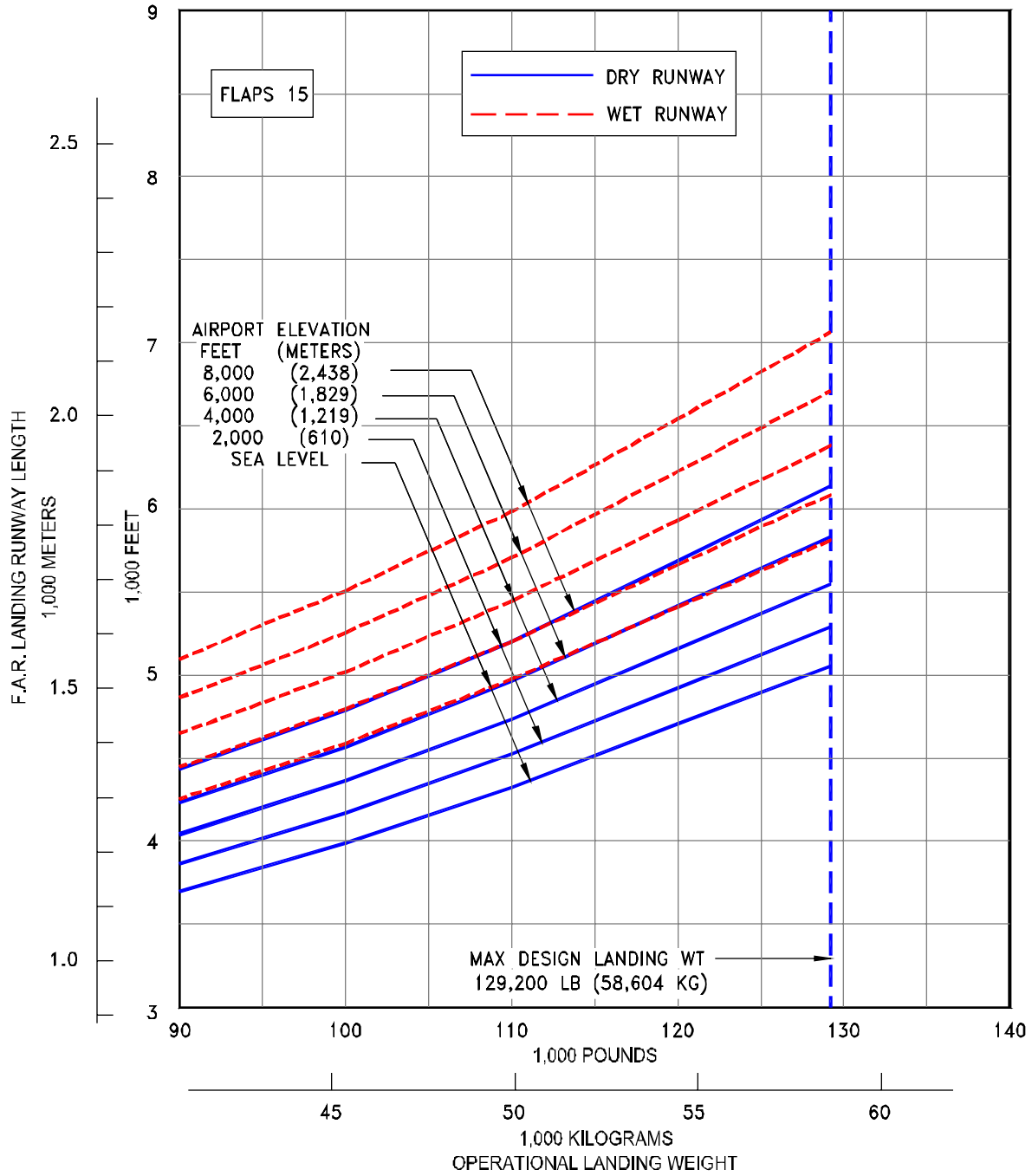

3.4.27 F.A.R. LANDING RUNWAY LENGTH REQUIREMENTS - FLAPS 15
 MODEL 737-700 WITH WINGLETS

NOTES:

- STANDARD DAY
- AUTO SPOILERS OPERATIVE
- ANTI-SKID OPERATIVE
- ZERO WIND
- CONSULT AIRCRAFT USER FOR SPECIFIC OPERATING PROCEDURE PRIOR TO FACILITY DESIGN

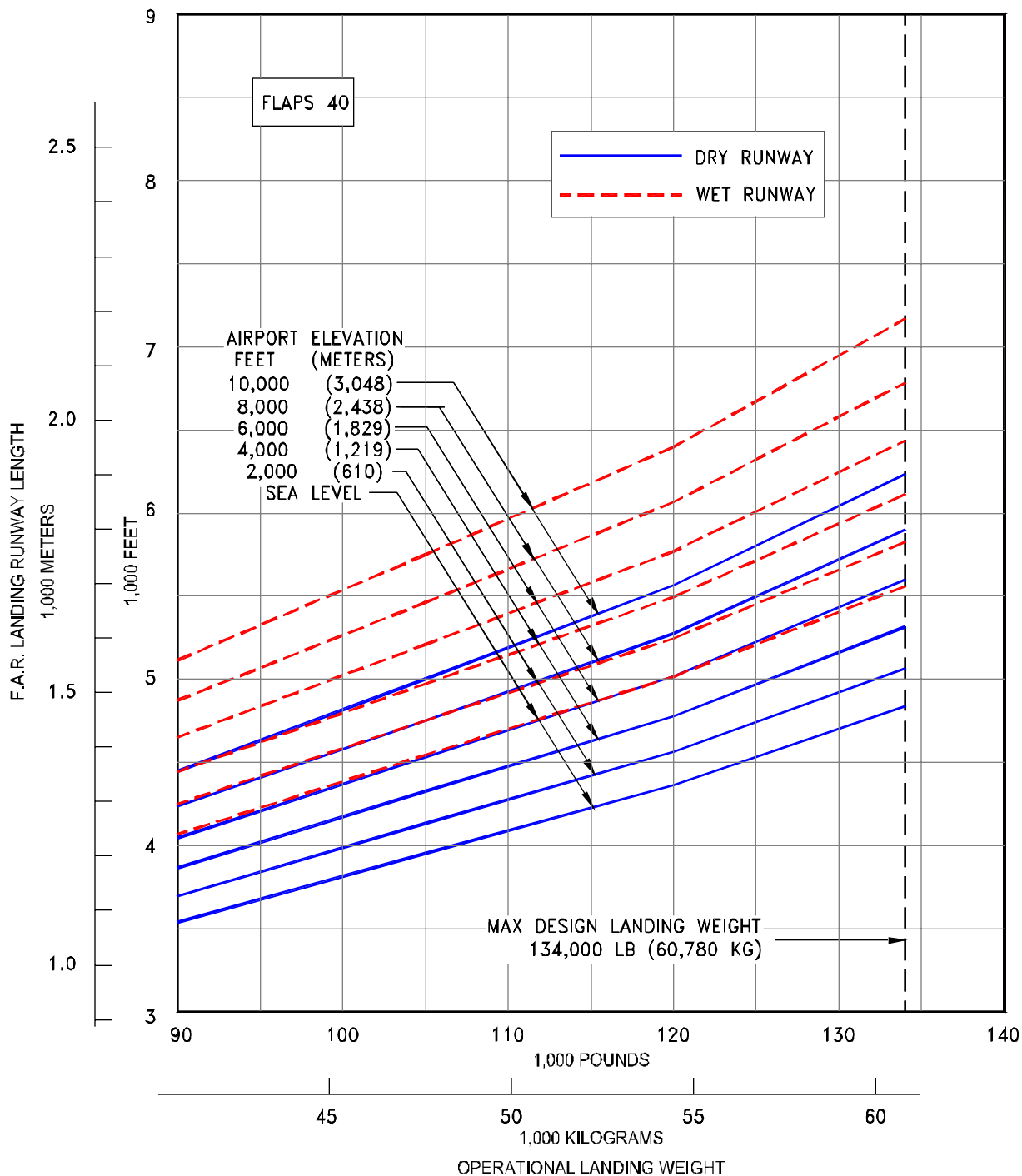

3.4.28 F.A.R. LANDING RUNWAY LENGTH REQUIREMENTS - FLAPS 40
 MODEL 737 BBJ

NOTES:

- STANDARD DAY
- AUTO SPOILERS OPERATIVE
- ANTI-SKID OPERATIVE
- ZERO WIND
- CONSULT AIRCRAFT USER FOR SPECIFIC OPERATING PROCEDURE PRIOR TO FACILITY DESIGN

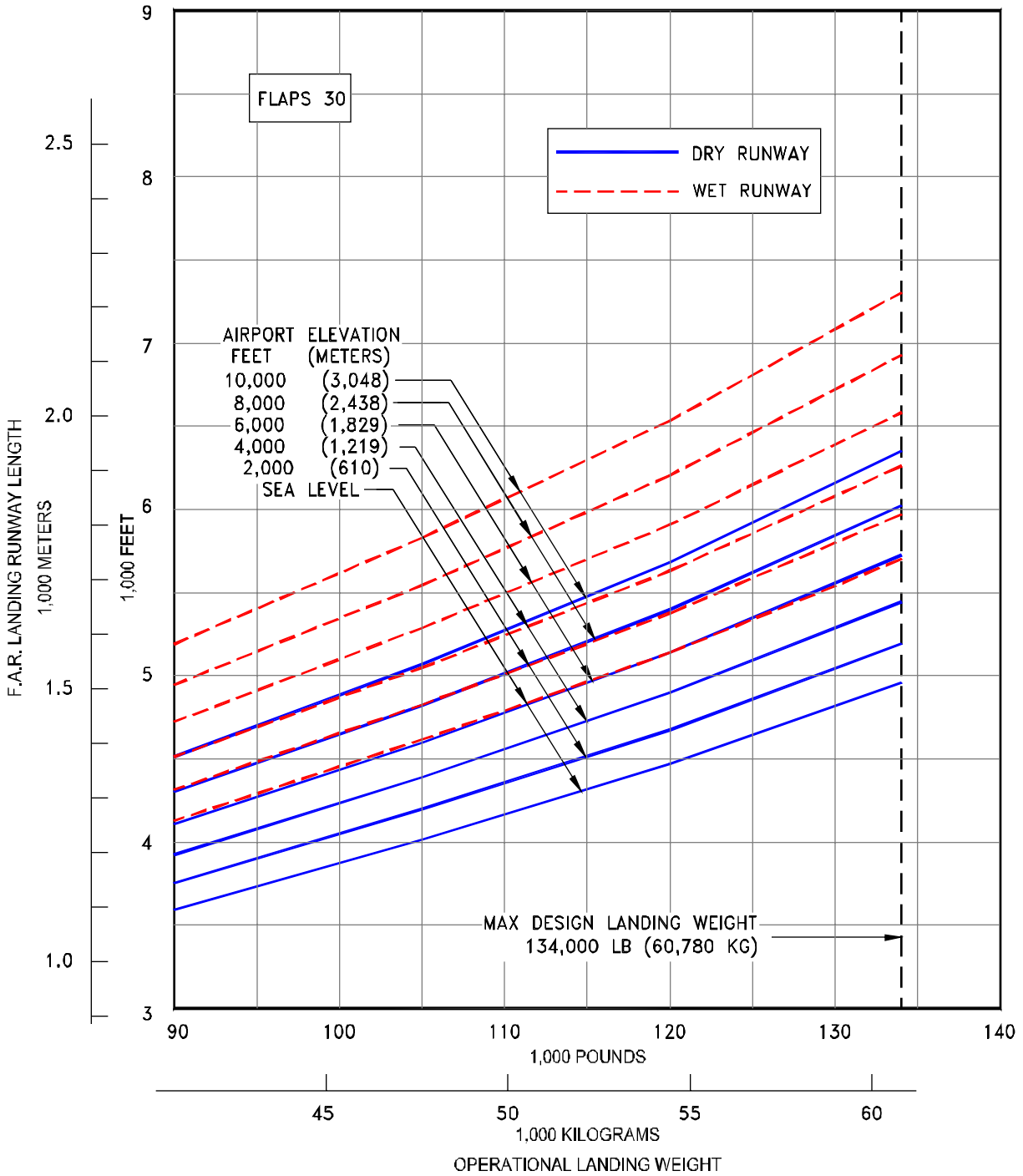

3.4.29 F.A.R. LANDING RUNWAY LENGTH REQUIREMENTS - FLAPS 30
 MODEL 737 BBJ

NOTES:

- STANDARD DAY
- AUTO SPOILERS OPERATIVE
- ANTI-SKID OPERATIVE
- ZERO WIND
- CONSULT USING AIRLINE FOR SPECIFIC OPERATING PROCEDURE PRIOR TO FACILITY DESIGN

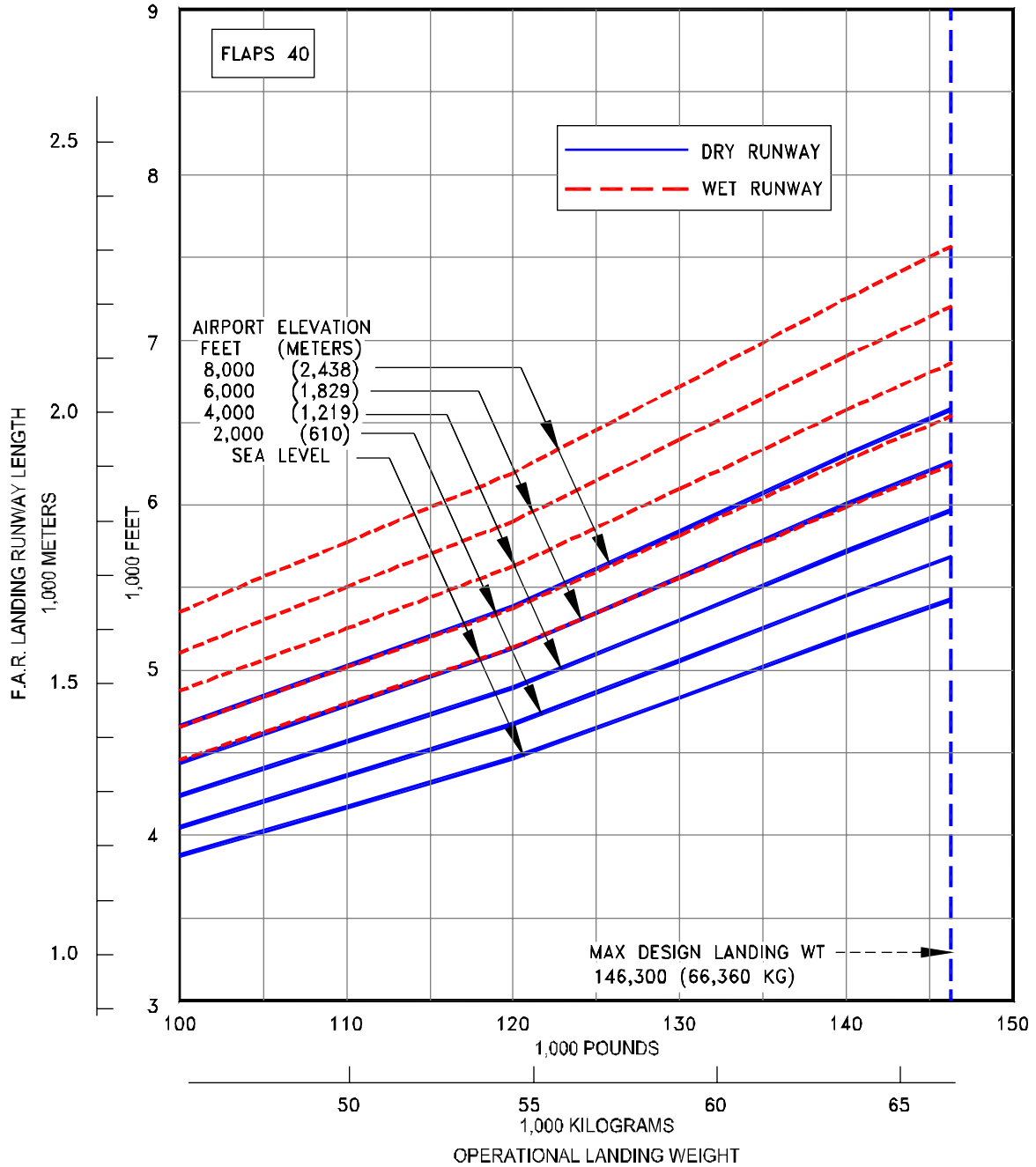

3.4.30 F.A.R. LANDING RUNWAY LENGTH REQUIREMENTS - FLAPS 40
MODEL 737-800

NOTES:

- STANDARD DAY
- AUTO SPOILERS OPERATIVE
- ANTI-SKID OPERATIVE
- ZERO WIND
- CONSULT USING AIRLINE FOR SPECIFIC OPERATING PROCEDURE PRIOR TO FACILITY DESIGN

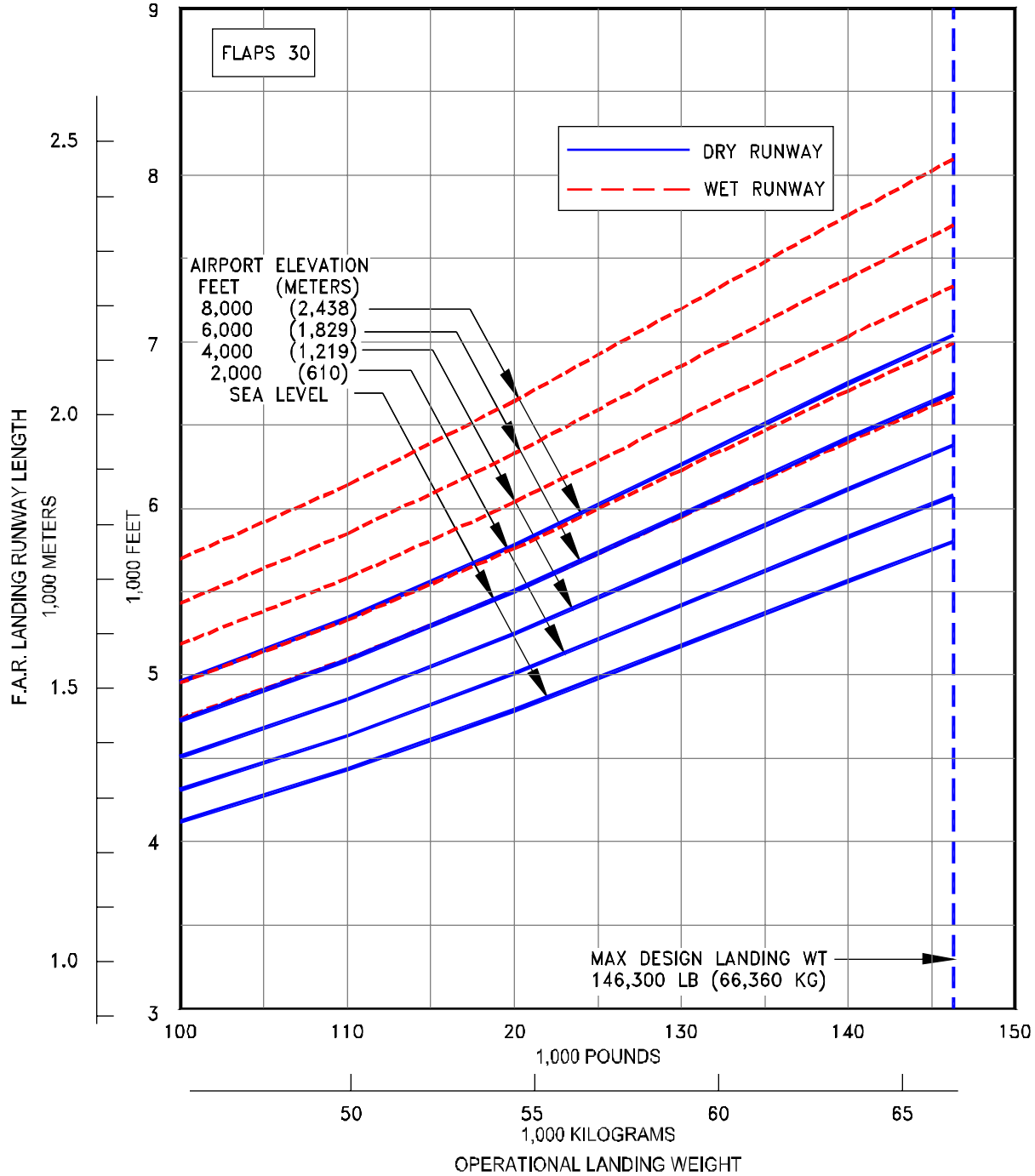

3.4.31 F.A.R. LANDING RUNWAY LENGTH REQUIREMENTS - FLAPS 30
 MODEL 737-800

NOTES:

- STANDARD DAY
- AUTO SPOILERS OPERATIVE
- ANTI-SKID OPERATIVE
- ZERO WIND
- CONSULT USING AIRLINE FOR SPECIFIC OPERATING PROCEDURE PRIOR TO FACILITY DESIGN

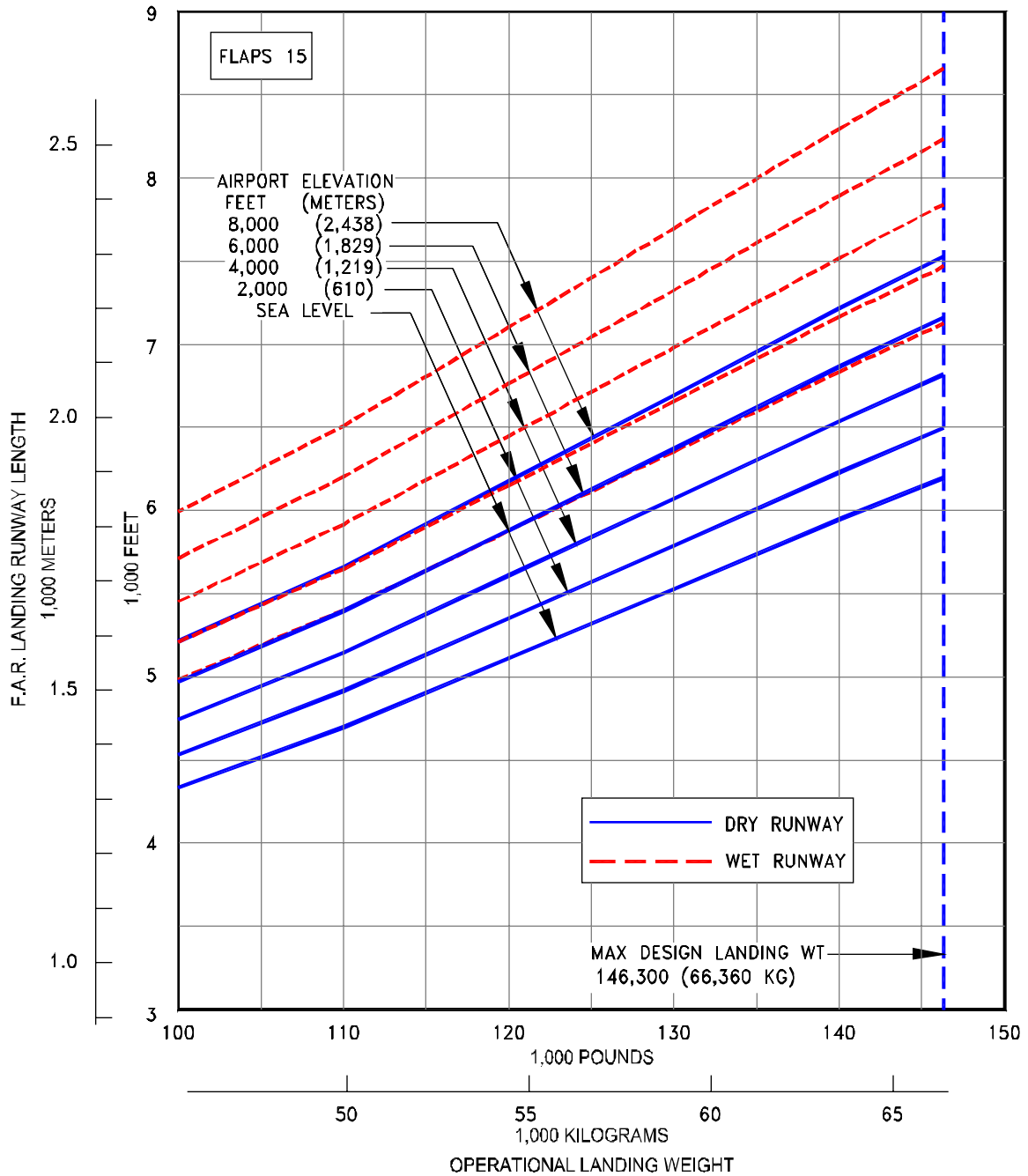

3.4.32 F.A.R. LANDING RUNWAY LENGTH REQUIREMENTS - FLAPS 15
MODEL 737-800

NOTES:

- STANDARD DAY
- AUTO SPOILERS OPERATIVE
- ANTI-SKID OPERATIVE
- ZERO WIND
- CONSULT USING AIRLINE FOR SPECIFIC OPERATING PROCEDURE PRIOR TO FACILITY DESIGN

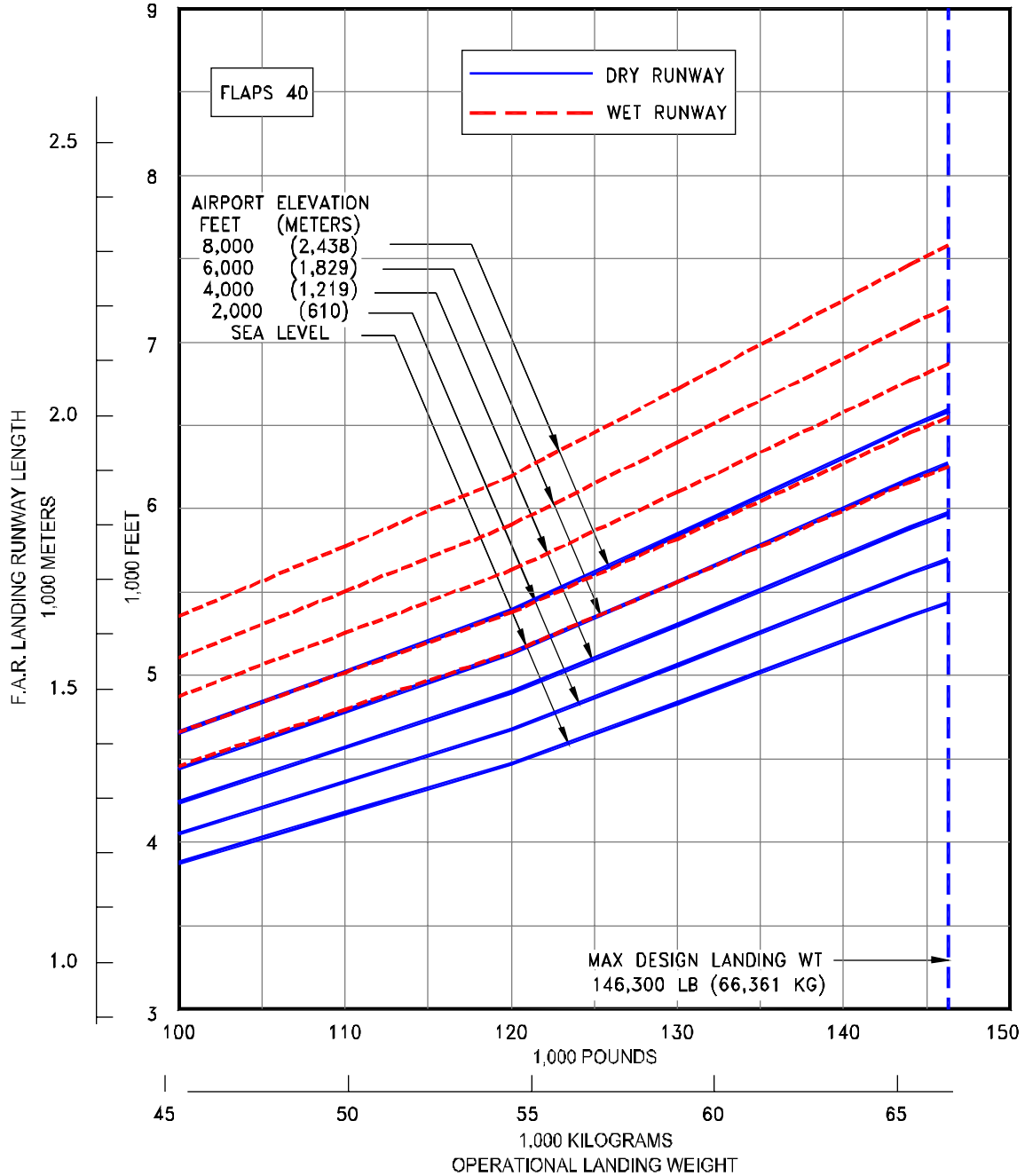

3.4.33 F.A.R. LANDING RUNWAY LENGTH REQUIREMENTS - FLAPS 40
 MODEL 737-800 WITH WINGLETS

NOTES:

- STANDARD DAY
- AUTO SPOILERS OPERATIVE
- ANTI-SKID OPERATIVE
- ZERO WIND
- CONSULT USING AIRLINE FOR SPECIFIC OPERATING PROCEDURE PRIOR TO FACILITY DESIGN

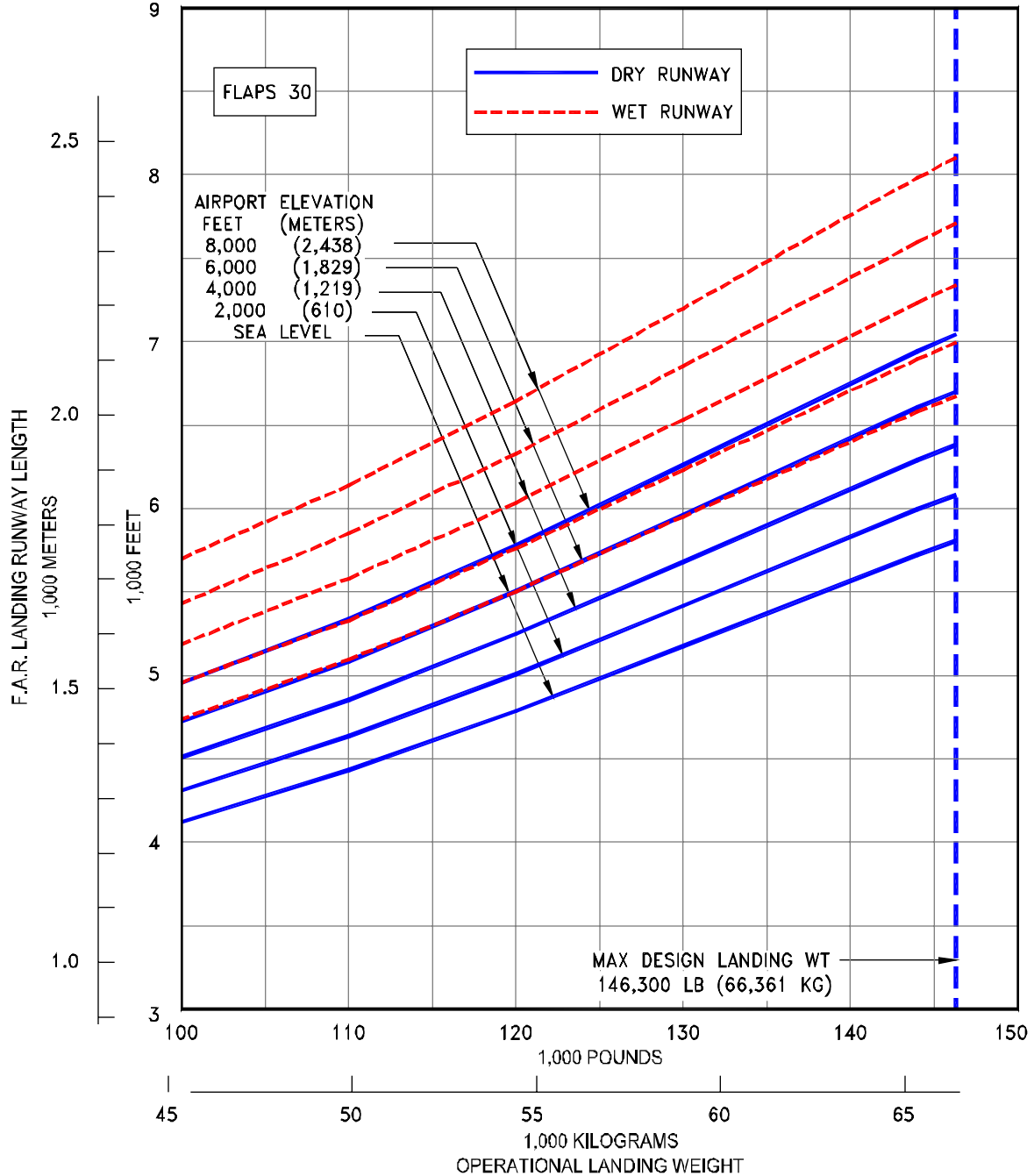

3.4.34 F.A.R. LANDING RUNWAY LENGTH REQUIREMENTS - FLAPS 30
 MODEL 737-800 WITH WINGLETS

NOTES:

- STANDARD DAY
- AUTO SPOILERS OPERATIVE
- ANTI-SKID OPERATIVE
- ZERO WIND
- CONSULT USING AIRLINE FOR SPECIFIC OPERATING PROCEDURE PRIOR TO FACILITY DESIGN

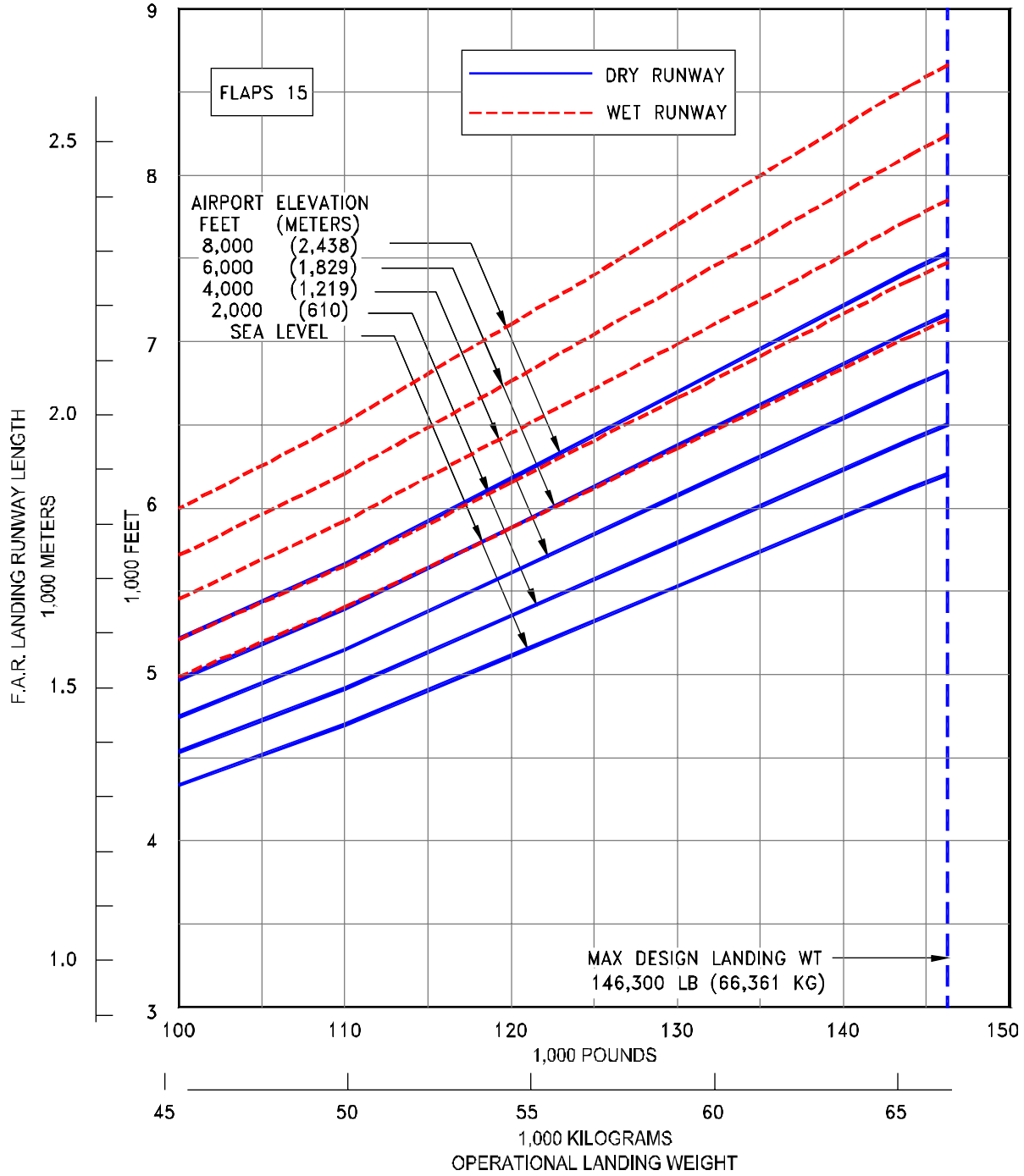

3.4.35 F.A.R. LANDING RUNWAY LENGTH REQUIREMENTS - FLAPS 15
MODEL 737-800 WITH WINGLETS

NOTES:

- STANDARD DAY
- AUTO SPOILERS OPERATIVE
- ANTI-SKID OPERATIVE
- ZERO WIND
- CONSULT AIRCRAFT USER FOR SPECIFIC OPERATING PROCEDURE PRIOR TO FACILITY DESIGN

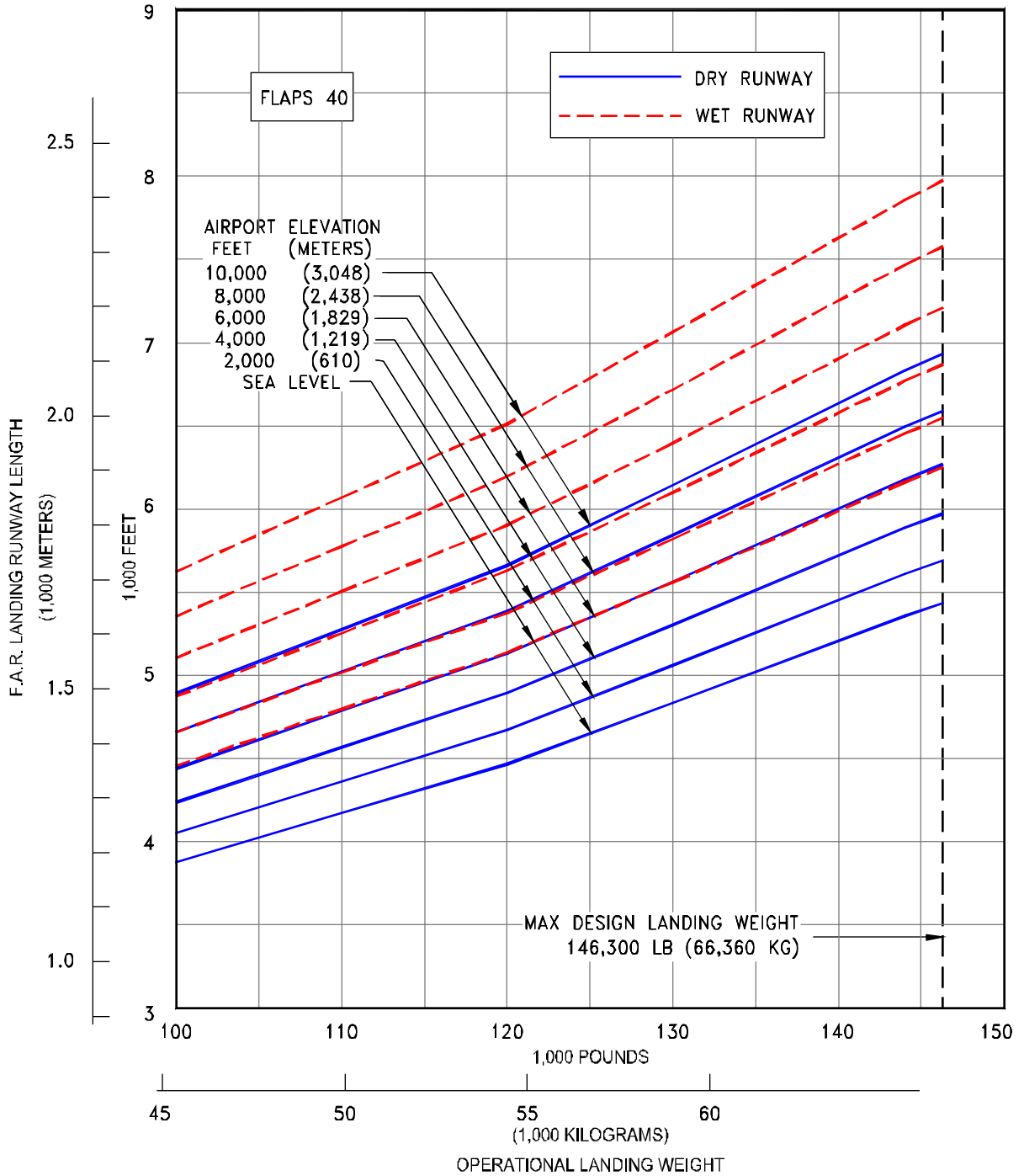

3.4.36 F.A.R LANDING RUNWAY LENGTH REQUIREMENTS - FLAPS 40
MODEL 737 BBJ2

NOTES:

- STANDARD DAY
- AUTO SPOILERS OPERATIVE
- ANTI-SKID OPERATIVE
- ZERO WIND
- CONSULT AIRCRAFT USER FOR SPECIFIC OPERATING PROCEDURE PRIOR TO FACILITY DESIGN

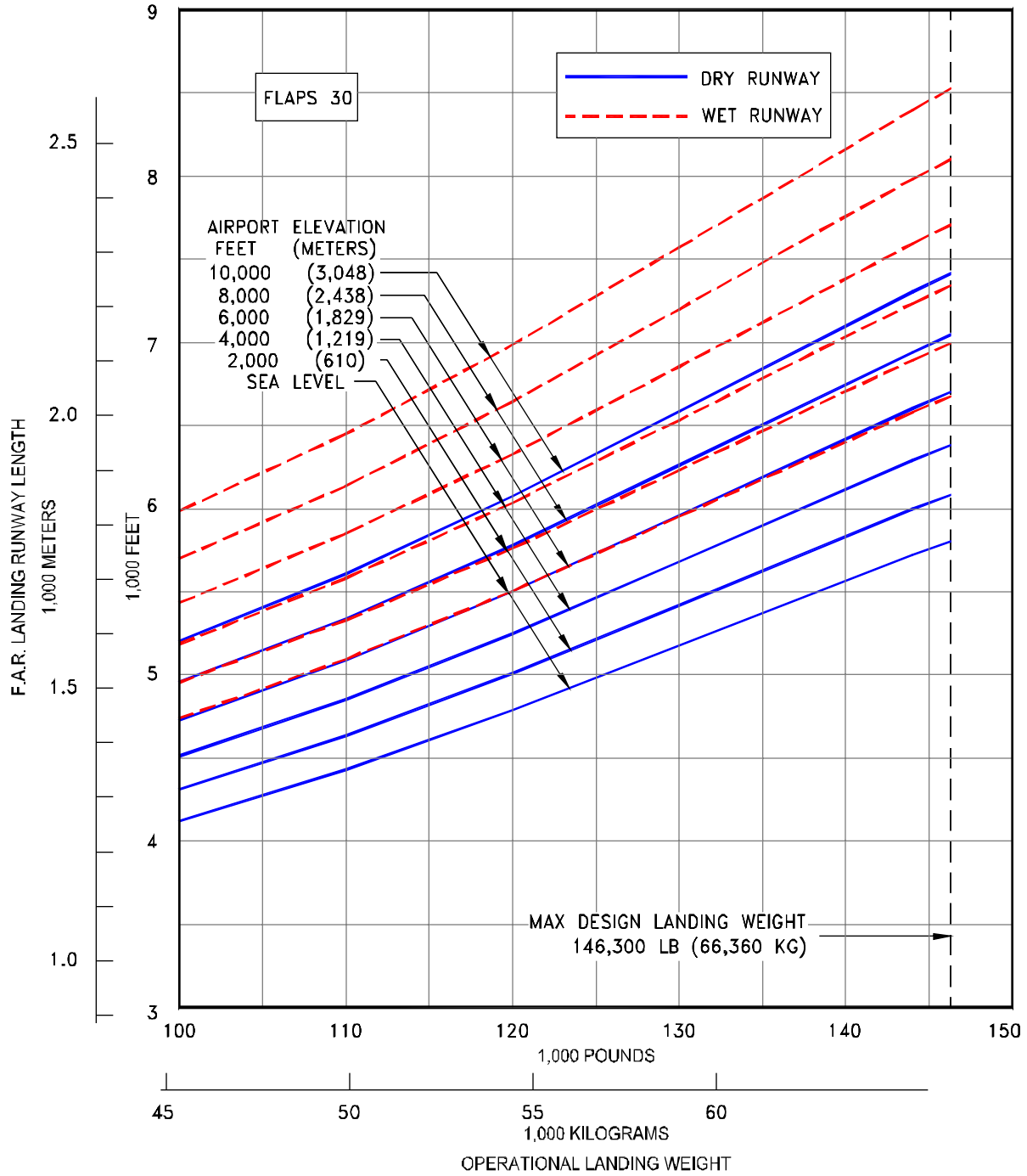

3.4.37 F.A.R. LANDING RUNWAY LENGTH REQUIREMENTS - FLAPS 30
 MODEL 737 BBJ2

NOTES:

- STANDARD DAY
- AUTO SPOILERS OPERATIVE
- ANTI-SKID OPERATIVE
- ZERO WIND
- CONSULT USING AIRLINE FOR SPECIFIC OPERATING PROCEDURE PRIOR TO FACILITY DESIGN

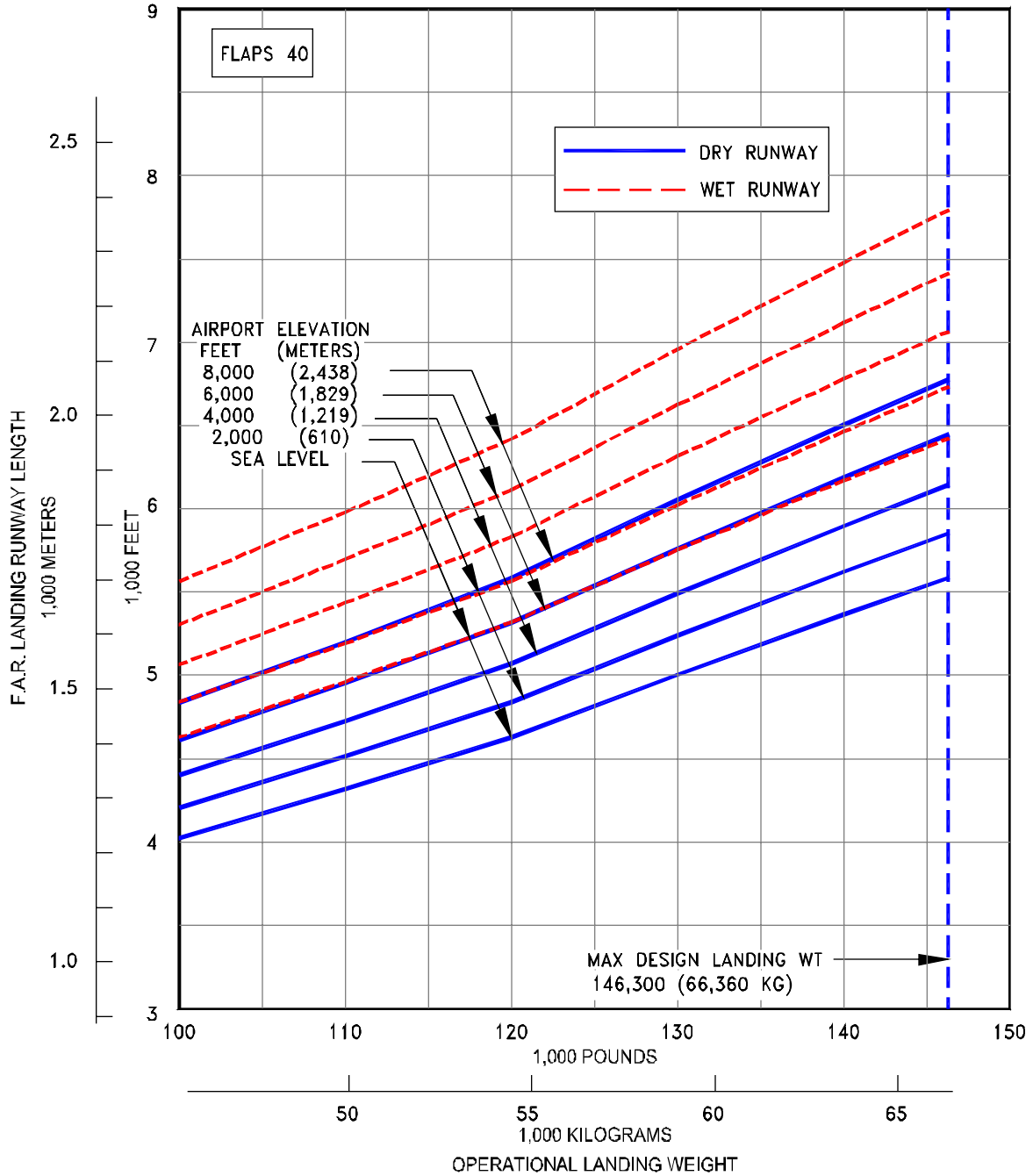

3.4.38 F.A.R. LANDING RUNWAY LENGTH REQUIREMENTS - FLAPS 40
MODEL 737-900

- NOTES:
- STANDARD DAY
 - AUTO SPOILERS OPERATIVE
 - ANTI-SKID OPERATIVE
 - ZERO WIND
 - CONSULT USING AIRLINE FOR SPECIFIC OPERATING PROCEDURE PRIOR TO FACILITY DESIGN

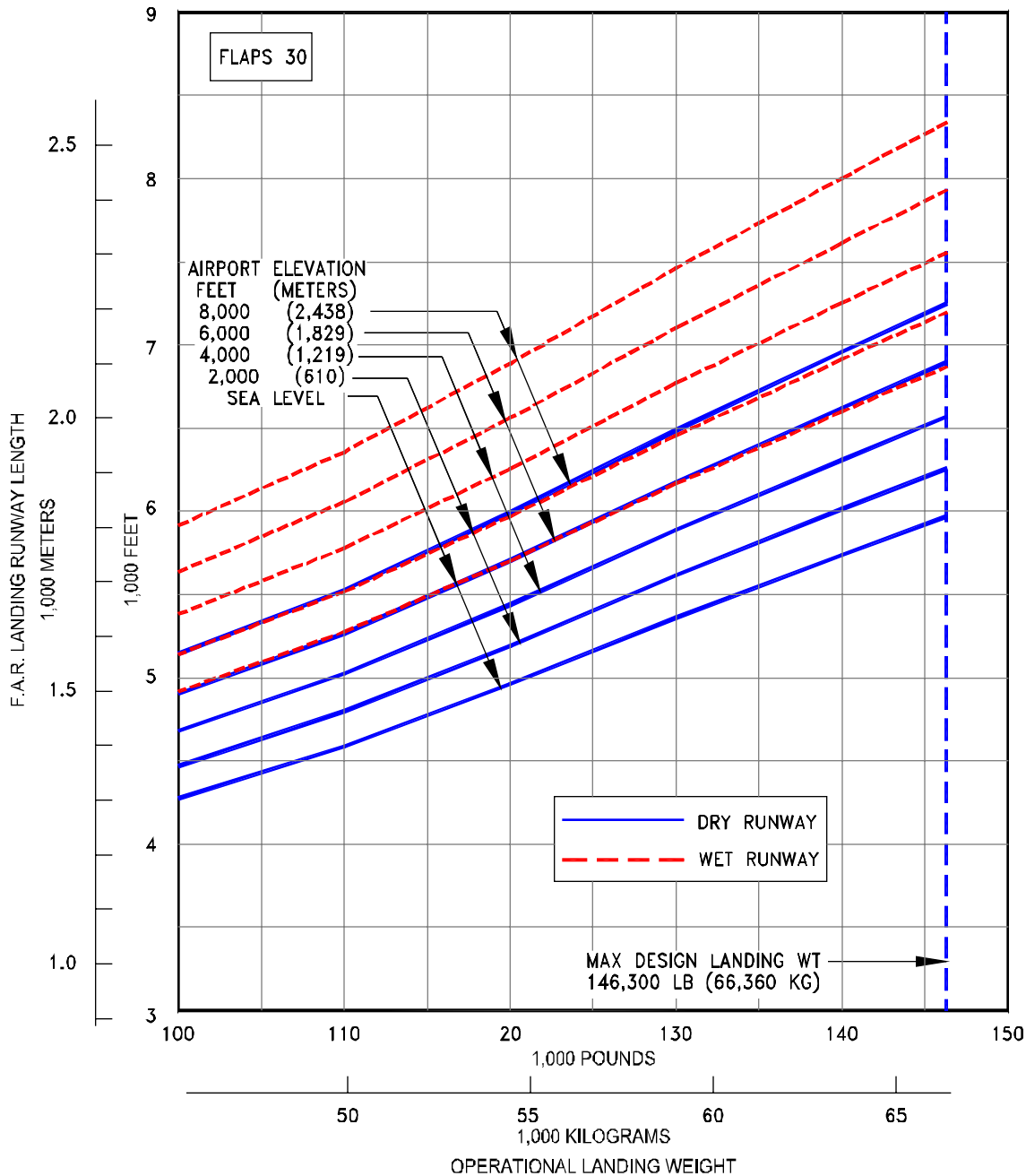

3.4.39 F.A.R. LANDING RUNWAY LENGTH REQUIREMENTS - FLAPS 30
 MODEL 737-900

NOTES:

- STANDARD DAY
- AUTO SPOILERS OPERATIVE
- ANTI-SKID OPERATIVE
- ZERO WIND
- CONSULT USING AIRLINE FOR SPECIFIC OPERATING PROCEDURE PRIOR TO FACILITY DESIGN

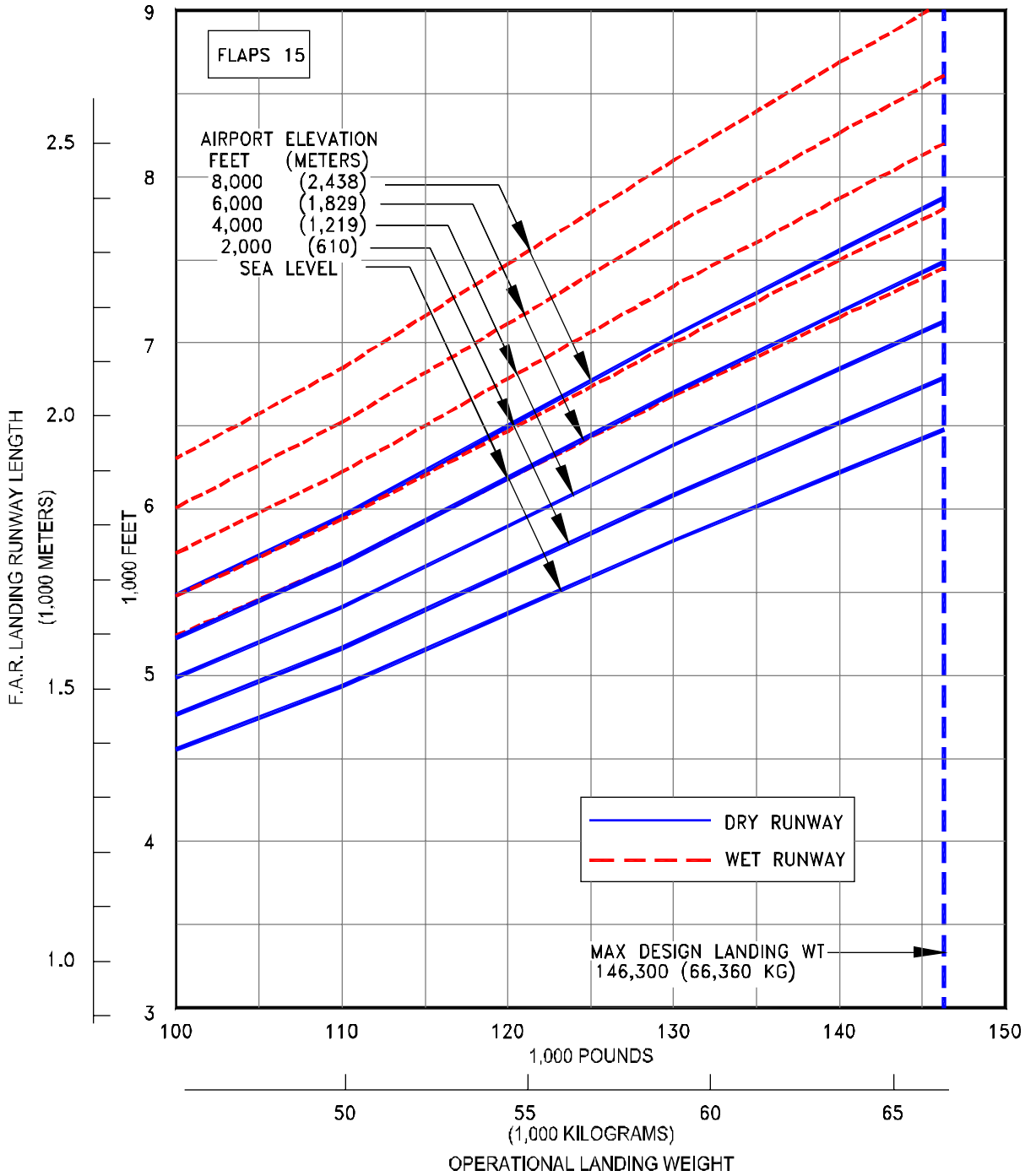

3.4.40 F.A.R. LANDING RUNWAY LENGTH REQUIREMENTS - FLAPS 15
MODEL 737-900

NOTES:

- STANDARD DAY
- AUTO SPOILERS OPERATIVE
- ANTI-SKID OPERATIVE
- ZERO WIND
- CONSULT USING AIRLINE FOR SPECIFIC OPERATING PROCEDURE PRIOR TO FACILITY DESIGN

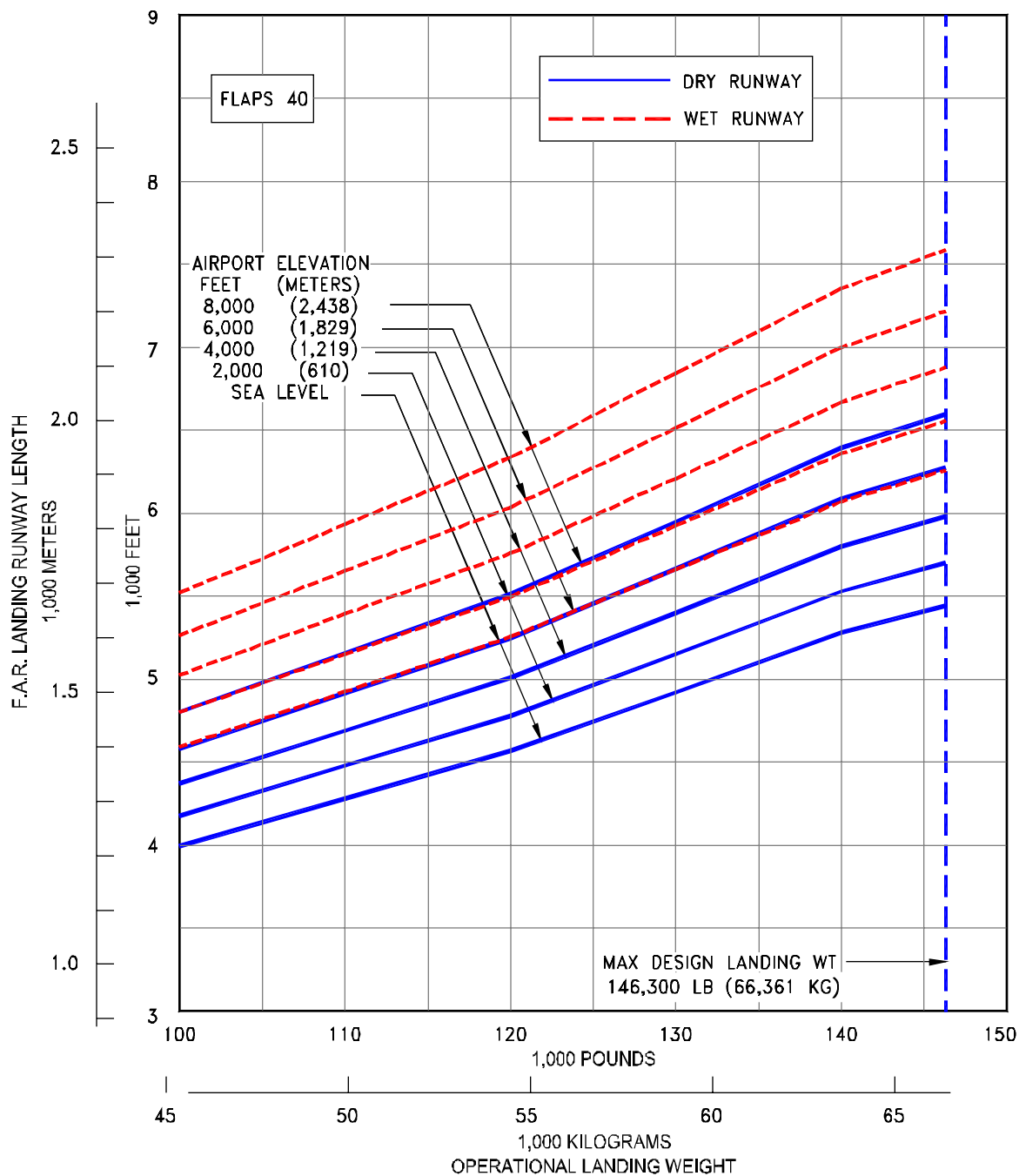

3.4.41 F.A.R. LANDING RUNWAY LENGTH REQUIREMENTS - FLAPS 30
 MODEL 737-900 WITH WINGLETS

NOTES:

- STANDARD DAY
- AUTO SPOILERS OPERATIVE
- ANTI-SKID OPERATIVE
- ZERO WIND
- CONSULT USING AIRLINE FOR SPECIFIC OPERATING PROCEDURE PRIOR TO FACILITY DESIGN

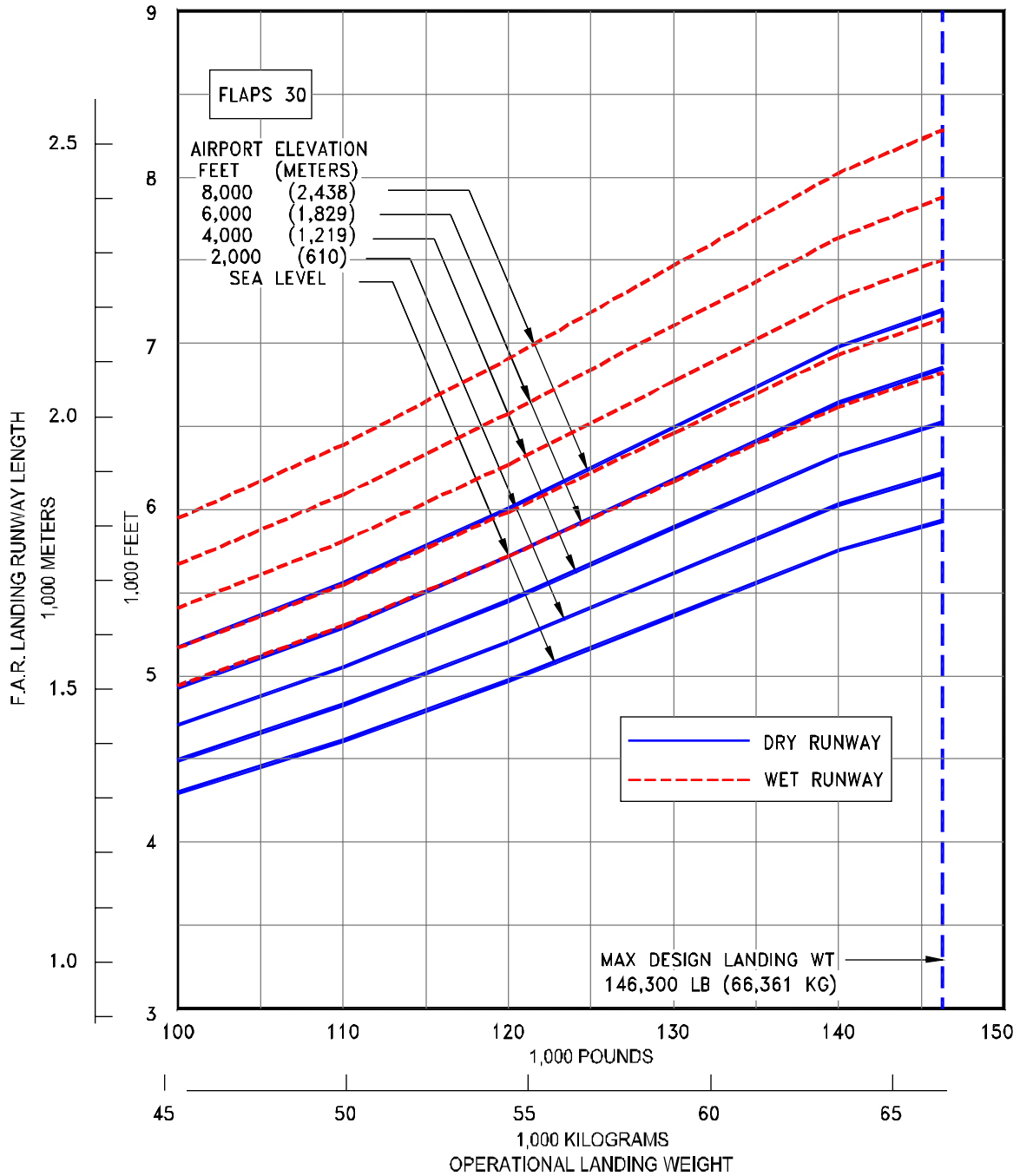

3.4.42 F.A.R. LANDING RUNWAY LENGTH REQUIREMENTS - FLAPS 30
MODEL 737-900 WITH WINGLETS

NOTES:

- STANDARD DAY
- AUTO SPOILERS OPERATIVE
- ANTI-SKID OPERATIVE
- ZERO WIND
- CONSULT USING AIRLINE FOR SPECIFIC OPERATING PROCEDURE PRIOR TO FACILITY DESIGN

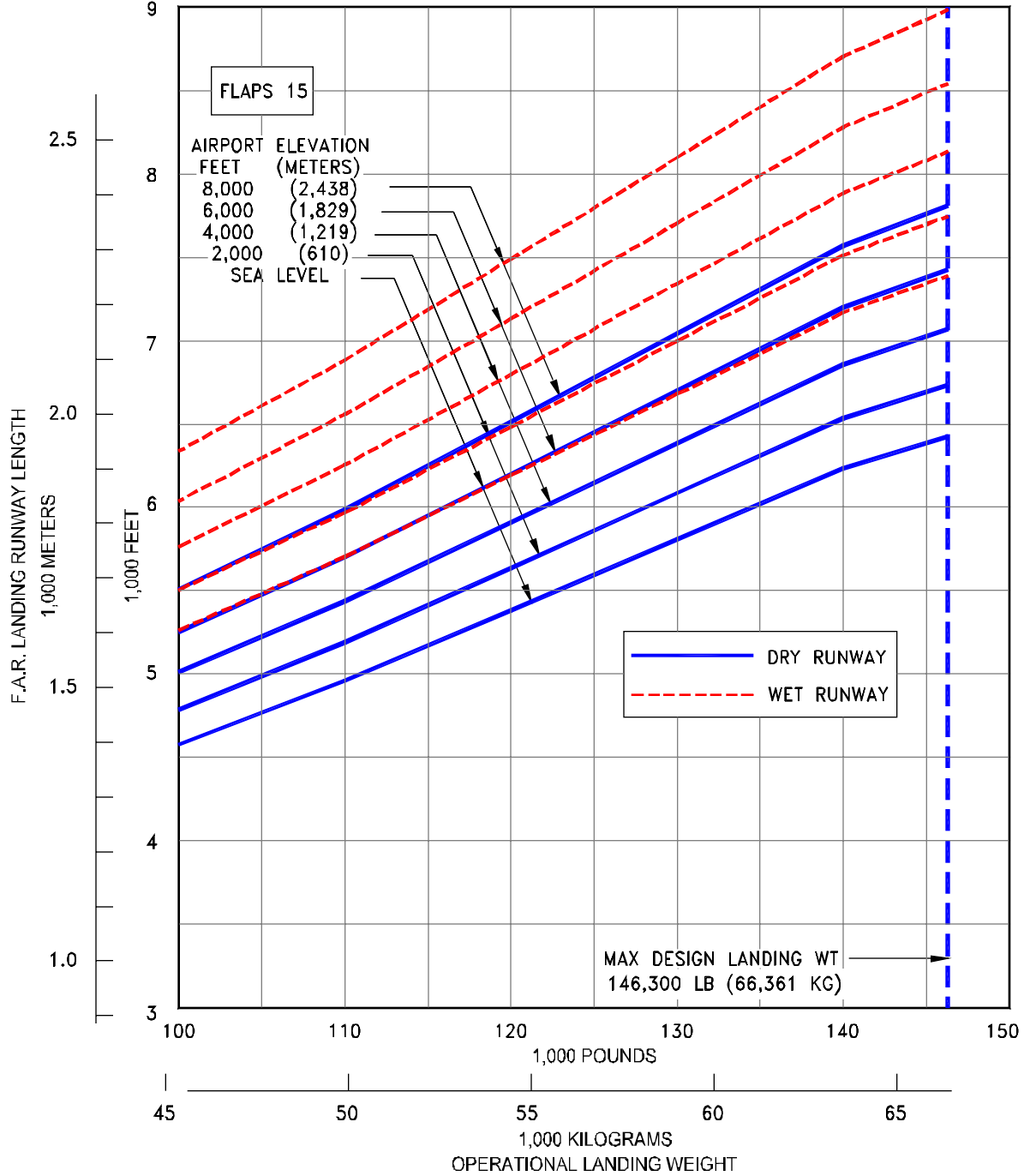

3.4.43 F.A.R. LANDING RUNWAY LENGTH REQUIREMENTS - FLAPS 15
MODEL 737-900 WITH WINGLETS

PRELIMINARY INFORMATION

NOTES:

- STANDARD DAY
- AUTO SPOILERS OPERATIVE
- ANTI-SKID OPERATIVE
- ZERO WIND
- CONSULT USING AIRLINE FOR SPECIFIC OPERATING PROCEDURE PRIOR TO FACILITY DESIGN

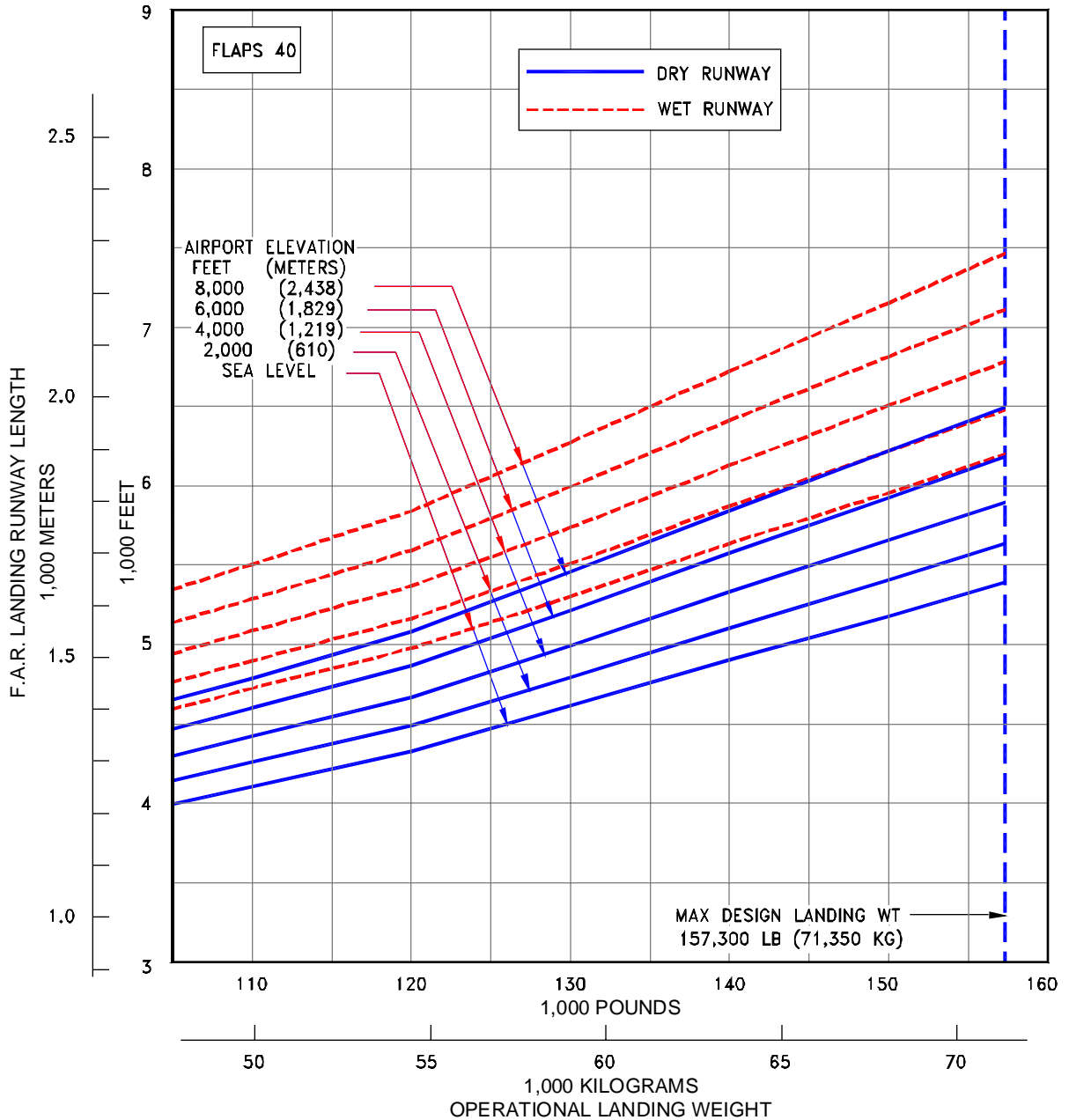

3.4.44 F.A.R. LANDING RUNWAY LENGTH REQUIREMENTS – FLAPS 40
 MODEL 737-900 ER

PRELIMINARY INFORMATION

NOTES:

- STANDARD DAY
- AUTO SPOILERS OPERATIVE
- ANTI-SKID OPERATIVE
- ZERO WIND
- CONSULT USING AIRLINE FOR SPECIFIC OPERATING PROCEDURE PRIOR TO FACILITY DESIGN

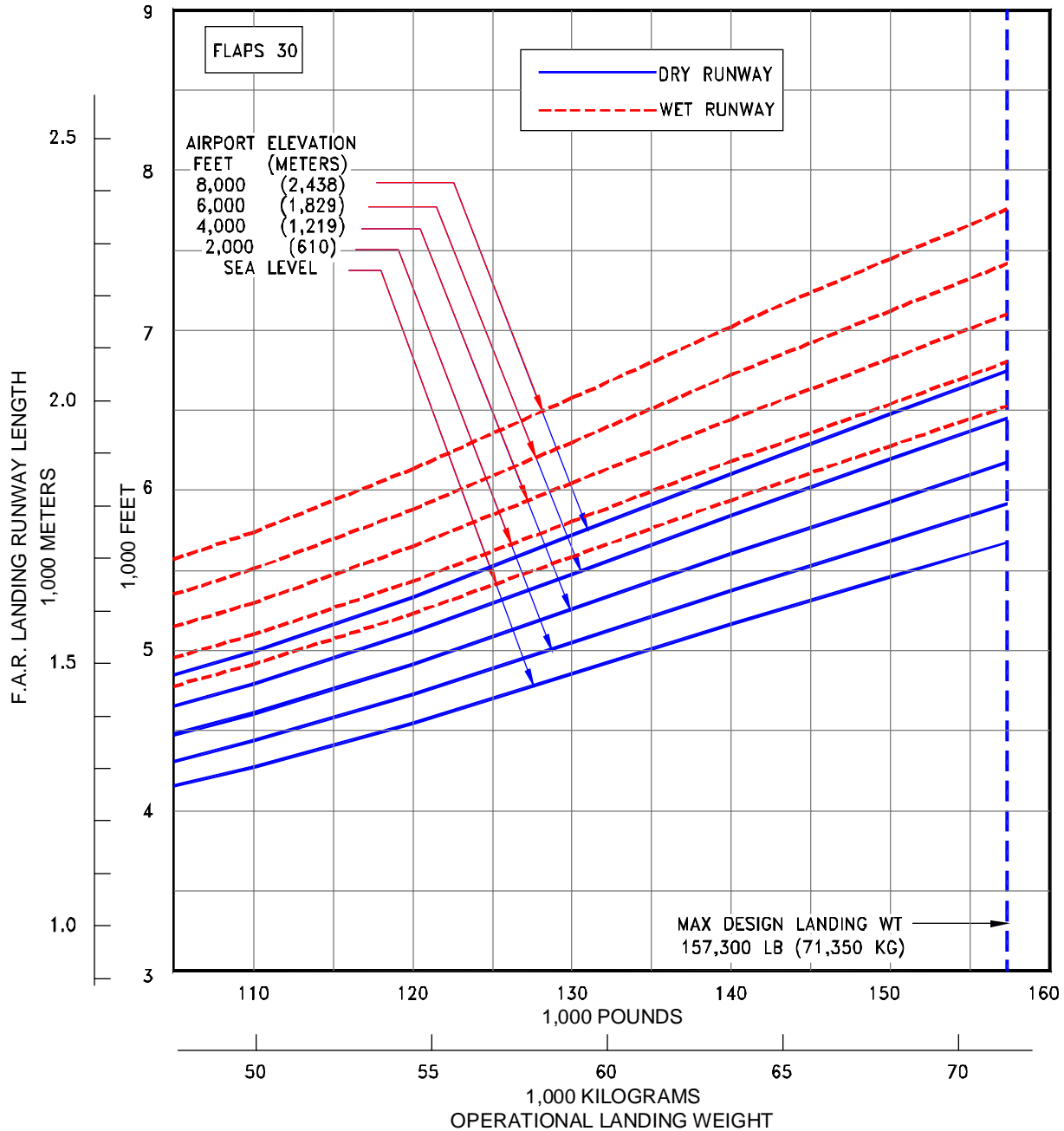

3.4.45 F.A.R. LANDING RUNWAY LENGTH REQUIREMENTS – FLAPS 30
 MODEL 737-900 ER

PRELIMINARY INFORMATION

NOTES:

- STANDARD DAY
- AUTO SPOILERS OPERATIVE
- ANTI-SKID OPERATIVE
- ZERO WIND
- CONSULT USING AIRLINE FOR SPECIFIC OPERATING PROCEDURE PRIOR TO FACILITY DESIGN

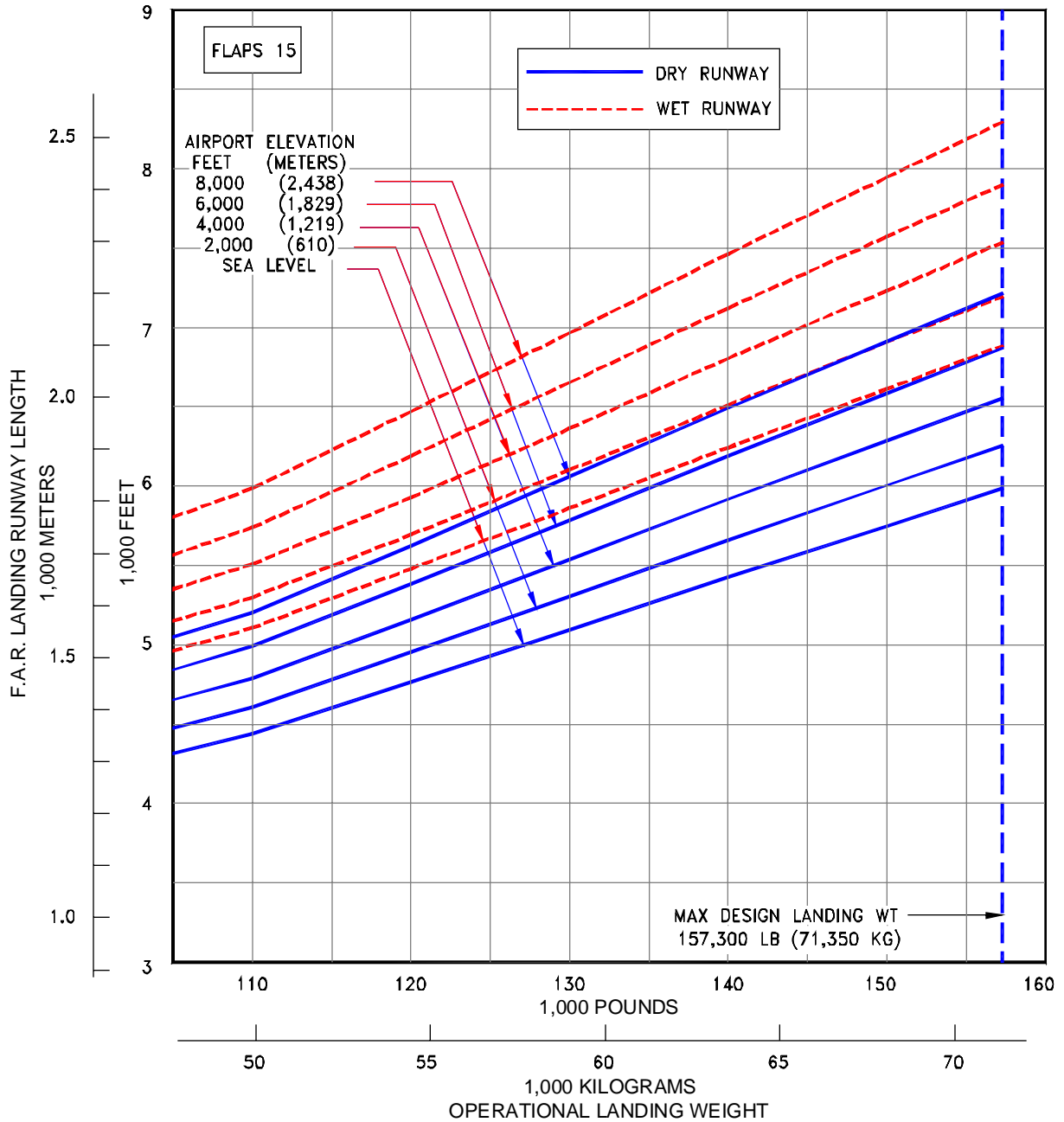

3.4.46 F.A.R. LANDING RUNWAY LENGTH REQUIREMENTS – FLAPS 15
 MODEL 737-900ER

PRELIMINARY INFORMATION

THIS PAGE INTENTIONALLY LEFT BLANK

4.0 GROUND MANEUVERING

4.1 General Information

4.2 Turning Radii

4.3 Clearance Radii

4.4 Visibility from Cockpit in Static Position

4.5 Runway and Taxiway Turn Paths

4.6 Runway Holding Bay

4.0 GROUND MANEUVERING

4.1 General Information

The 737 landing gear system is a conventional tricycle-type. The main gear consists of two dual wheel assemblies, one on each side of the fuselage. The nose gear is a dual-wheel assembly.

Sections 4.2 and 4.3 show turning radii for various nose gear steering angles. Radii for the main and nose gears are measured from the outside edge of the tire, rather than from the center of the wheel strut.

Section 4.4 shows the range of pilot's visibility from the cockpit within the limits of ambinoocular vision through the windows. Ambinoocular vision is defined as the total field of vision seen by both eyes at the same time.

The runway-taxiway turns in Section 4.5 show models 737-100 and 737-900 on a 100-ft (30-m) runway and 50-ft (15-m) taxiway system. Main gear tire tracks for the other airplane models will be between the tracks of the -100 and -900 models. Boeing 737 Series aircraft are able to operate on 100-foot wide runways worldwide. However, the FAA recommends the runway width criteria for the 737-700/-800/-900 is 150 ft (45 m) due to its maximum certificated takeoff weight.

Section 4.6 shows minimum holding apron requirements for the 737 airplane models. Holding aprons for larger aircraft should be adequate for the 737.

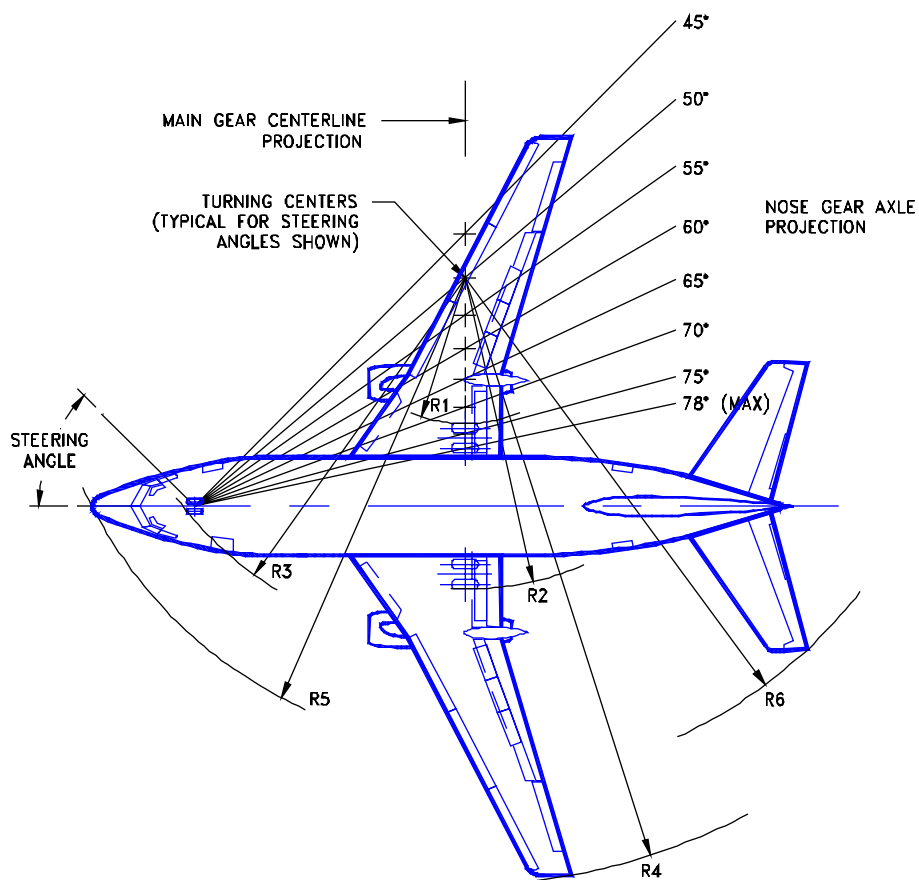

NOTES:

- * ACTUAL OPERATING TURNING RADII MAY BE GREATER THAN SHOWN
- * CONSULT WITH AIRLINE FOR SPECIFIC OPERATING PROCEDURE

STEERING ANGLE (DEGREES)	R1		R2		R3		R4		R5		R6	
	INNER GEAR		OUTER GEAR		NOSE GEAR		WING TIP		NOSE		TAIL	
	FT	M	FT	M	FT	M	FT	M	FT	M	FT	M
30	49.0	14.9	69.9	21.3	69.5	21.2	106.7	32.5	75.9	23.1	90.4	27.6
35	38.5	11.7	59.4	18.1	60.8	18.5	96.4	29.4	68.1	20.8	81.7	24.9
40	30.4	9.3	51.3	15.6	54.3	16.6	88.3	26.9	62.5	19.1	75.1	22.9
45	23.8	7.3	44.7	13.6	49.5	15.1	81.8	24.9	58.4	17.8	70.1	21.4
50	18.3	5.6	39.2	12.0	45.7	13.9	76.4	23.3	55.4	16.9	66.1	20.1
55	13.6	4.1	34.5	10.5	42.8	13.1	71.7	21.9	53.0	16.2	62.8	19.1
60	9.4	2.9	30.3	9.2	40.6	12.4	67.6	20.6	51.3	15.6	60.1	18.3
65	5.5	1.7	26.4	8.1	38.8	11.8	63.8	19.5	49.9	15.2	57.8	17.6
70	2.0	.6	22.9	7.0	37.5	11.4	60.4	18.4	48.9	14.9	55.8	17.0
75	1.3	.4	19.6	6.0	36.5	11.1	57.2	17.4	48.2	14.7	54.0	16.5
78 (MAX)	3.2	1.0	17.7	5.4	36.0	11.0	55.3	16.9	47.9	14.6	53.1	16.2

4.2.1 TURNING RADII - NO SLIP ANGLE
MODEL 737-100

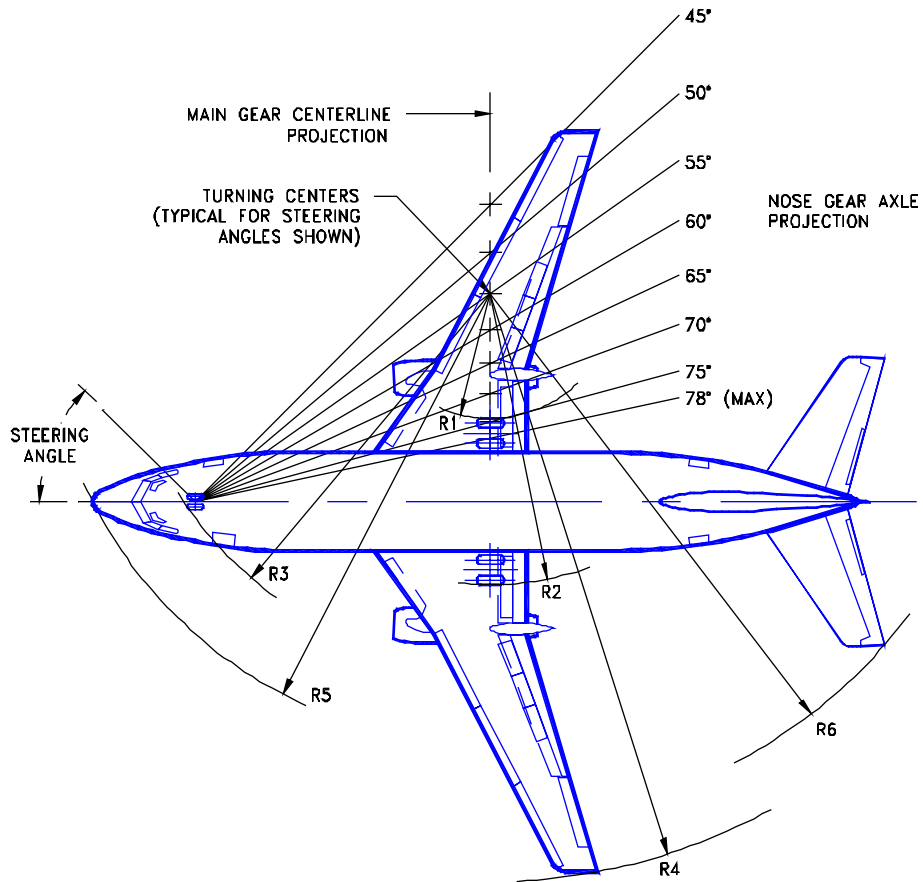

NOTES:

- * ACTUAL OPERATING TURNING RADII MAY BE GREATER THAN SHOWN
- * CONSULT WITH AIRLINE FOR SPECIFIC OPERATING PROCEDURE

STEERING ANGLE (DEGREES)	R1		R2		R3		R4		R5		R6	
	INNER GEAR		OUTER GEAR		NOSE GEAR		WING TIP		NOSE		TAIL	
	FT	M	FT	M	FT	M	FT	M	FT	M	FT	M
30	54.2	16.5	75.1	22.9	75.5	23.0	111.9	34.1	81.9	25.0	96.4	29.4
35	42.8	13.1	63.7	19.4	66.0	20.1	100.6	30.7	73.3	22.3	86.9	26.5
40	34.0	10.4	54.9	16.7	59.0	18.0	91.9	28.0	67.1	20.5	79.8	24.3
45	26.8	8.2	47.7	14.6	53.7	16.4	84.8	25.8	62.6	19.1	74.4	22.7
50	20.8	6.4	41.7	12.7	49.6	15.1	78.9	24.0	59.2	18.1	70.0	21.3
55	15.7	4.8	36.6	11.1	46.5	14.2	73.8	22.5	56.7	17.3	66.5	20.3
60	11.1	3.4	32.0	9.7	44.0	13.4	69.3	21.1	54.7	16.7	63.5	19.4
65	6.9	2.1	27.8	8.5	42.1	12.8	65.2	19.9	53.2	16.2	61.0	18.6
70	3.1	1.0	24.0	7.3	40.6	12.4	61.5	18.7	52.1	15.9	58.9	17.9
75	0.5	.1	20.4	6.2	39.6	12.1	58.0	17.7	51.3	15.6	57.0	17.4
78 (MAX)	2.5	.8	18.4	5.6	39.1	11.9	56.0	17.1	50.9	15.5	56.1	17.1

4.2.2 TURNING RADII - NO SLIP ANGLE

MODEL 737-200

D6-58325-6

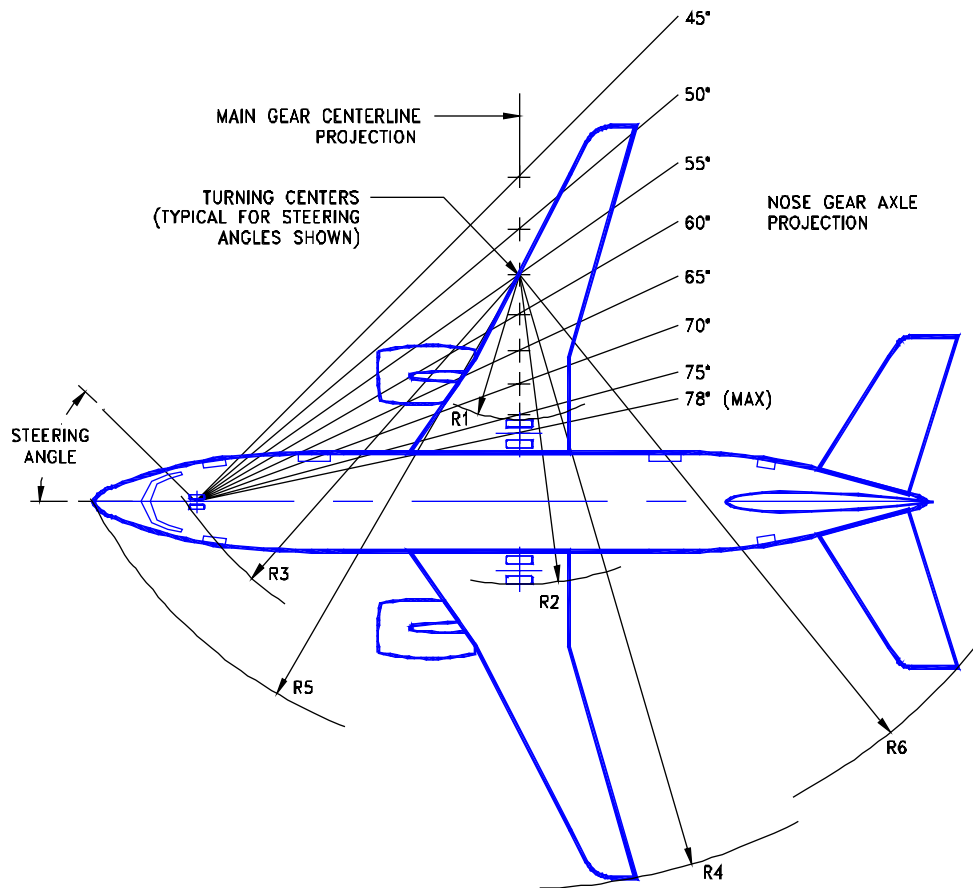

NOTES:

- * ACTUAL OPERATING TURNING RADII MAY BE GREATER THAN SHOWN
- * CONSULT WITH AIRLINE FOR SPECIFIC OPERATING PROCEDURE

STEERING ANGLE (DEGREES)	R1		R2		R3		R4		R5		R6	
	INNER GEAR		OUTER GEAR		NOSE GEAR		WING TIP		NOSE		TAIL	
	FT	M	FT	M	FT	M	FT	M	FT	M	FT	M
30	60.2	18.4	81.1	24.7	82.5	25.2	119.0	36.3	88.9	27.1	107.1	32.6
35	47.8	14.6	68.7	20.9	72.1	22.0	106.7	32.5	79.4	24.2	96.7	29.5
40	38.2	11.6	59.1	18.0	64.4	19.6	97.2	29.6	72.7	22.1	89.0	27.1
45	30.3	9.3	51.2	15.6	58.6	17.9	89.5	27.3	67.7	20.6	83.0	25.3
50	23.8	7.2	44.7	13.6	54.2	16.5	83.0	25.3	63.9	19.5	78.3	23.9
55	18.1	5.5	39.0	11.9	50.8	15.5	77.4	23.6	61.1	18.6	74.4	22.7
60	13.1	4.0	34.0	10.4	48.1	14.6	72.5	22.1	58.9	18.0	71.2	21.7
65	8.6	2.6	29.5	9.0	46.0	14.0	68.1	20.8	57.3	17.5	68.4	20.9
70	4.4	1.3	25.3	7.7	44.4	13.5	64.0	19.5	56.0	17.1	66.1	20.1
75	0.5	.1	21.4	6.5	43.2	13.2	60.2	18.4	55.1	16.8	64.0	19.5
78 (MAX)	1.8	.5	19.1	5.8	42.7	13.0	58.0	17.7	54.7	16.7	63.0	19.2

4.2.3 TURNING RADII - NO SLIP ANGLE

MODEL 737-300

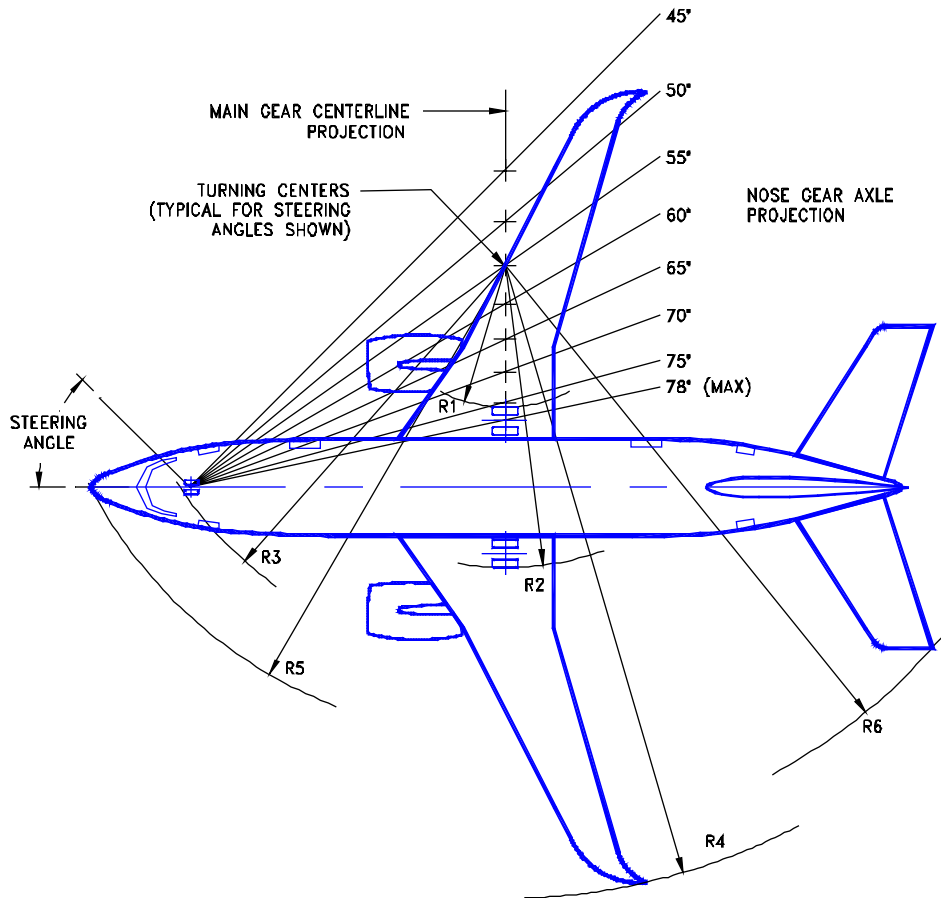

NOTES:

- * ACTUAL OPERATING TURNING RADI MAY BE GREATER THAN SHOWN
- * CONSULT WITH AIRLINE FOR SPECIFIC OPERATING PROCEDURE

STEERING ANGLE (DEGREES)	R1		R2		R3		R4		R5		R6	
	INNER GEAR		OUTER GEAR		NOSE GEAR		WING TIP		NOSE		TAIL	
	FT	M	FT	M	FT	M	FT	M	FT	M	FT	M
30	60.2	18.4	81.1	24.7	82.5	25.2	123.6	37.3	88.9	27.1	107.1	32.6
35	47.8	14.6	68.7	20.9	72.1	22.0	111.3	33.9	79.4	24.2	96.7	29.5
40	38.2	11.6	59.1	18.0	64.4	19.6	101.9	31.1	72.7	22.1	89.0	27.1
45	30.3	9.3	51.2	15.6	58.6	17.9	94.2	28.7	67.7	20.6	83.0	25.3
50	23.8	7.2	44.7	13.6	54.2	16.5	87.8	26.8	63.9	19.5	78.3	23.9
55	18.1	5.5	39.0	11.9	50.8	15.5	82.3	25.1	61.1	18.6	74.4	22.7
60	13.1	4.0	34.0	10.4	48.1	14.6	77.5	23.6	58.9	18.0	71.2	21.7
65	8.6	2.6	29.5	9.0	46.0	14.0	73.1	22.3	57.3	17.5	68.4	20.9
70	4.4	1.3	25.3	7.7	44.4	13.5	69.1	21.1	56.0	17.1	66.1	20.1
75	0.5	.1	21.4	6.5	43.2	13.2	65.4	19.9	55.1	16.8	64.0	19.5
78 (MAX)	1.8	.5	19.1	5.8	42.7	13.0	63.2	19.3	54.7	16.7	63.0	19.2

4.2.3 TURNING RADI - NO SLIP ANGLE
MODEL 737-300 WITH WINGLETS

D6-58325-6

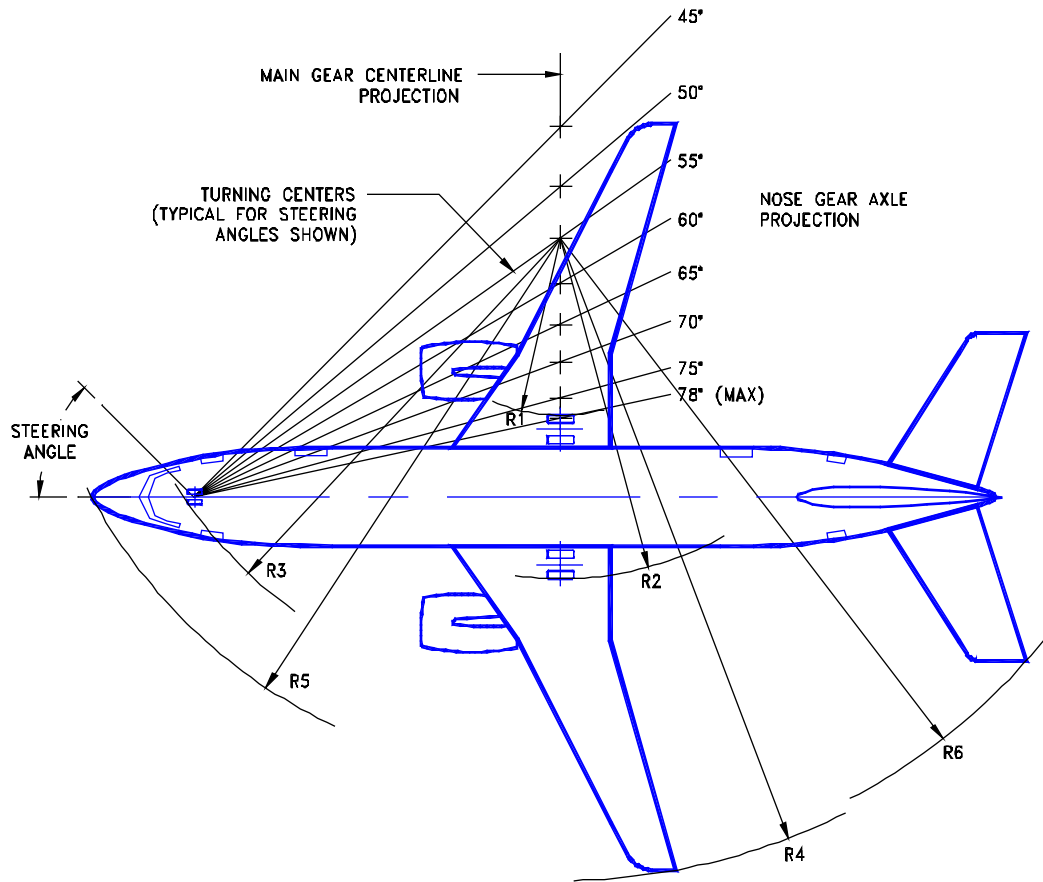

NOTES:

- * ACTUAL OPERATING TURNING RADII MAY BE GREATER THAN SHOWN
- * CONSULT WITH AIRLINE FOR SPECIFIC OPERATING PROCEDURE

STEERING ANGLE (DEGREES)	R1		R2		R3		R4		R5		R6	
	INNER GEAR		OUTER GEAR		NOSE GEAR		WING TIP		NOSE		TAIL	
	FT	M	FT	M	FT	M	FT	M	FT	M	FT	M
30	70.7	21.5	91.6	27.9	94.7	28.8	129.3	39.4	100.9	30.8	118.1	36.0
35	56.4	17.2	77.3	23.6	82.6	25.2	115.2	35.1	89.8	27.4	106.0	32.3
40	45.3	13.8	66.3	20.2	73.8	22.5	104.2	31.8	81.9	25.0	97.1	29.6
45	36.4	11.1	57.3	17.5	67.2	20.5	95.3	29.1	76.1	23.2	90.2	27.5
50	28.8	8.8	49.8	15.2	62.1	18.9	87.9	26.8	71.7	21.9	84.6	25.8
55	22.3	6.8	43.3	13.2	58.2	17.7	81.5	24.8	68.4	20.8	80.2	24.4
60	16.6	5.1	37.5	11.4	55.1	16.8	75.8	23.1	65.8	20.1	76.4	23.3
65	11.4	3.5	32.3	9.8	52.7	16.1	70.8	21.6	63.9	19.5	73.3	22.3
70	6.6	2.0	27.5	8.4	50.8	15.5	66.1	20.1	62.4	19.0	70.6	21.5
75	2.1	0.6	23.0	7.0	49.5	15.1	61.7	18.8	61.3	18.7	68.3	20.8
78 (MAX)	-0.5	-0.2	20.4	6.2	48.9	14.9	59.2	18.0	60.8	18.5	67.1	20.4

4.2.4 TURNING RADII - NO SLIP ANGLE

MODEL 737-400

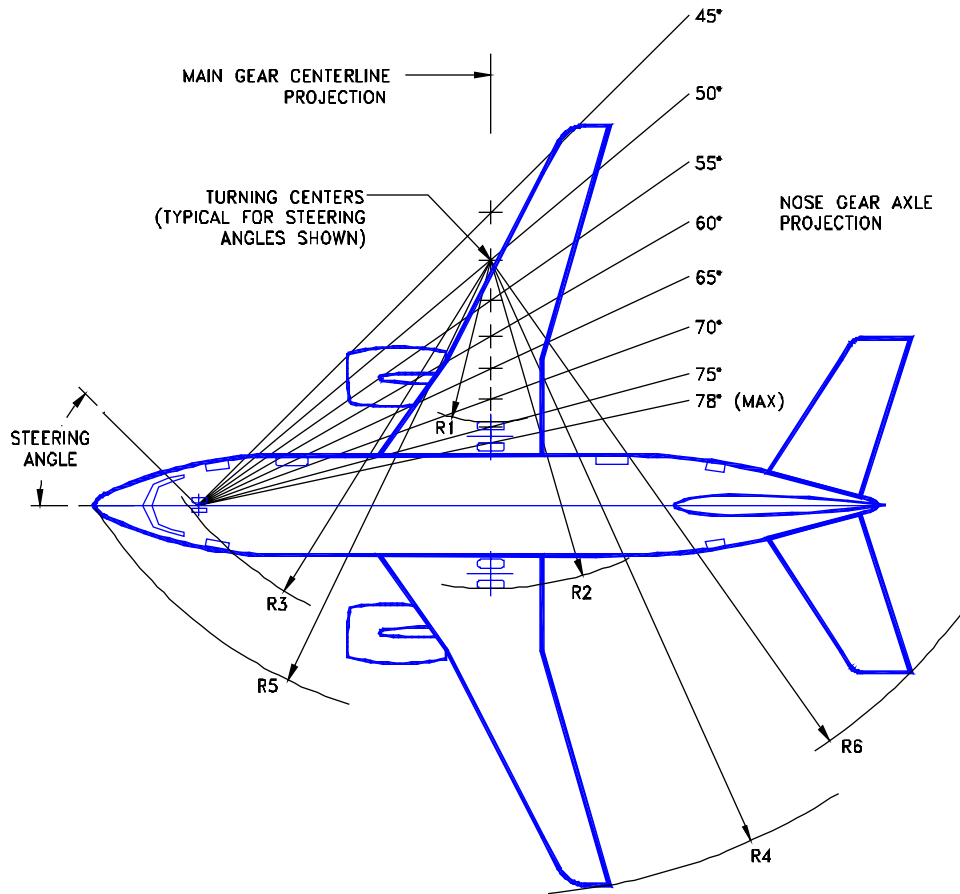

NOTES:

- * ACTUAL OPERATING TURNING RADII MAY BE GREATER THAN SHOWN
- * CONSULT WITH AIRLINE FOR SPECIFIC OPERATING PROCEDURE

STEERING ANGLE (DEGREES)	R1		R2		R3		R4		R5		R6	
	INNER GEAR		OUTER GEAR		NOSE GEAR		WING TIP		NOSE		TAIL	
	FT	M	FT	M	FT	M	FT	M	FT	M	FT	M
30	52.4	16.0	73.3	22.3	73.5	22.4	111.3	33.9	80.0	24.4	98.7	30.1
35	41.4	12.6	62.3	19.0	64.2	19.6	100.4	30.6	71.7	21.8	89.6	27.3
40	32.8	10.0	53.7	16.4	57.4	17.5	91.9	28.0	65.7	20.0	82.7	25.2
45	25.8	7.9	46.7	14.2	52.3	15.9	85.0	25.9	61.4	18.7	77.5	23.6
50	20.0	6.1	40.9	12.5	48.3	14.7	79.3	24.2	58.1	17.7	73.3	22.3
55	15.0	4.6	35.9	10.9	45.3	13.8	74.3	22.7	55.6	17.0	69.8	21.3
60	10.5	3.2	31.4	9.6	42.9	13.1	70.0	21.3	53.8	16.4	67.0	20.4
65	6.5	2.0	27.4	8.3	41.0	12.5	66.1	20.1	52.3	15.9	64.5	19.7
70	2.8	.8	23.7	7.2	39.6	12.1	62.4	19.0	51.2	15.6	62.4	19.0
75	0.7	.2	20.2	6.1	38.5	11.7	59.1	18.0	50.4	15.4	60.6	18.5
78 (MAX)	2.7	.8	18.2	5.5	38.1	11.6	57.1	17.4	50.1	15.3	59.6	18.2

4.2.5 TURNING RADII - NO SLIP ANGLE

MODEL 737-500

D6-58325-6

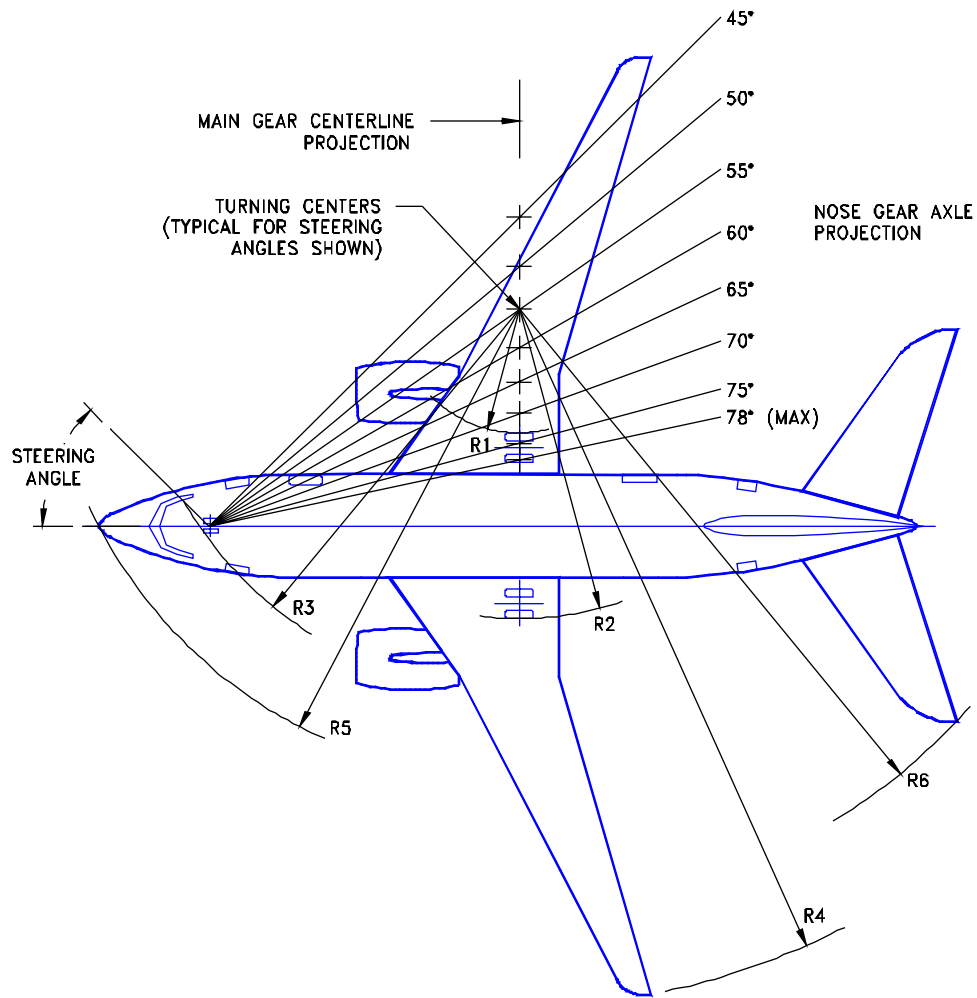

NOTES:

- * ACTUAL OPERATING TURNING RADII MAY BE GREATER THAN SHOWN
- * CONSULT WITH AIRLINE FOR SPECIFIC OPERATING PROCEDURE

STEERING ANGLE (DEGREES)	R1		R2		R3		R4		R5		R6	
	INNER GEAR		OUTER GEAR		NOSE GEAR		WING TIP		NOSE		TAIL	
	FT	M	FT	M	FT	M	FT	M	FT	M	FT	M
30	52.1	15.9	75.2	22.9	74.0	22.6	121.2	36.9	81.0	24.7	101.7	31.0
35	40.9	12.5	64.0	19.5	64.6	19.7	110.2	33.6	72.6	22.1	92.3	28.1
40	32.2	9.8	55.3	16.9	57.8	17.6	101.6	31.0	66.6	20.3	85.3	26.0
45	25.2	7.7	48.3	14.7	52.7	16.1	94.7	28.9	62.2	19.0	79.9	24.3
50	26.2	5.9	42.4	12.9	48.7	14.9	88.8	27.1	58.9	17.9	75.5	23.0
55	14.2	4.3	37.3	11.4	45.7	13.9	83.8	25.6	56.4	17.2	71.9	21.9
60	9.7	2.9	32.8	10.0	43.3	13.2	79.4	24.2	54.5	16.6	68.9	21.0
65	5.6	1.7	28.7	8.7	41.4	12.6	75.5	23.0	53.0	16.2	66.3	20.2
70	1.8	0.6	24.9	7.6	40.0	12.2	71.8	21.9	51.9	15.8	64.1	19.5
78 (MAX)	-3.7	-1.1	19.4	5.9	38.5	11.7	66.4	20.2	50.8	15.5	61.0	18.6

4.2.6 TURNING RADII - NO SLIP ANGLE
MODEL 737-600

D6-58325-6

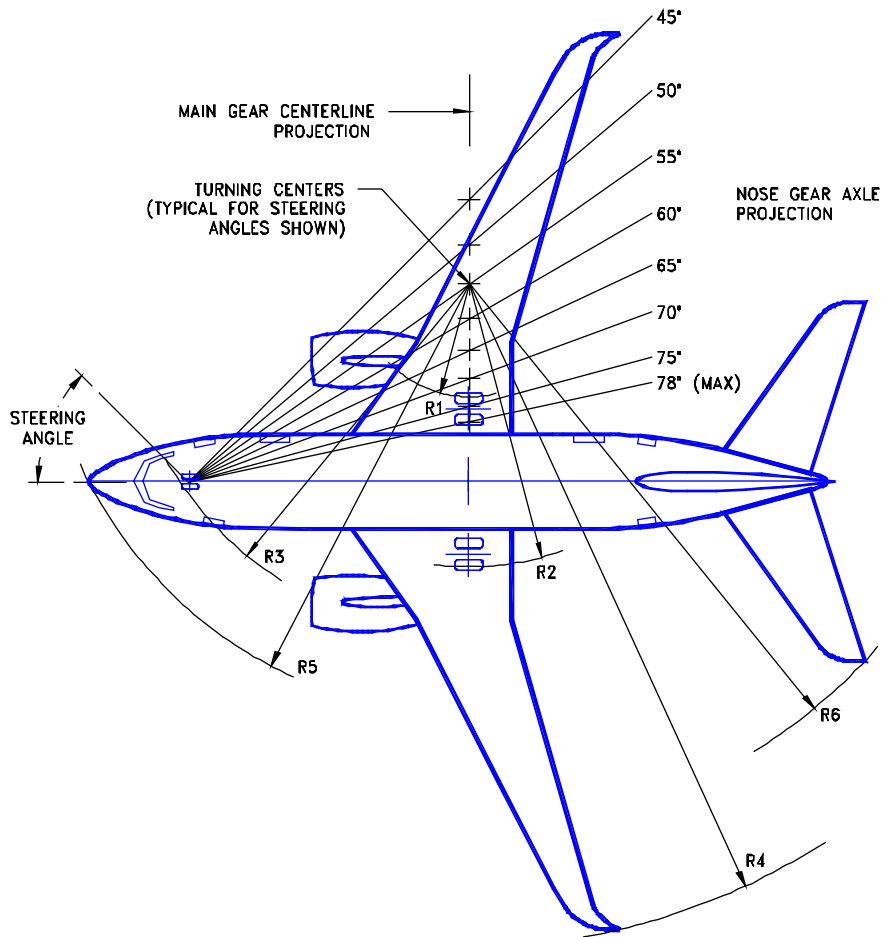

NOTES:

- * ACTUAL OPERATING TURNING RADII MAY BE GREATER THAN SHOWN
- * CONSULT WITH AIRLINE FOR SPECIFIC OPERATING PROCEDURE

STEERING ANGLE (DEGREES)	R1		R2		R3		R4		R5		R6	
	INNER GEAR		OUTER GEAR		NOSE GEAR		WING TIP		NOSE		TAIL	
	FT	M	FT	M	FT	M	FT	M	FT	M	FT	M
30	52.7	16.1	75.8	23.1	75.1	22.9	124.7	38.0	81.7	24.9	75.8	23.1
35	41.4	12.6	64.5	19.7	65.6	20.0	113.5	34.6	73.2	22.3	64.5	19.7
40	32.7	10.0	55.8	17.0	58.7	17.9	104.9	32.0	67.1	20.5	55.8	17.0
45	25.5	7.8	48.6	14.8	53.4	16.3	98.0	29.9	62.7	19.1	48.6	14.8
50	19.6	6.0	42.7	13.0	49.4	15.1	92.1	28.1	59.3	18.1	42.7	13.0
55	14.4	4.4	37.5	11.4	46.2	14.1	87.1	26.6	56.8	17.3	37.5	11.4
60	9.9	3.0	33.0	10.0	43.8	13.3	82.7	25.2	54.9	16.7	33.0	10.0
65	5.7	1.8	28.8	8.8	41.9	12.8	78.7	24.0	53.4	16.3	28.8	8.8
70	2.0	.6	25.1	7.6	40.4	12.3	75.1	22.9	52.3	15.9	25.1	7.6
78 (MAX)	3.7	1.1	19.4	5.9	38.9	11.9	69.7	21.2	51.1	15.6	19.4	5.9

4.2.6 TURNING RADII - NO SLIP ANGLE

MODEL 737-600 WITH WINGLETS

D6-58325-6

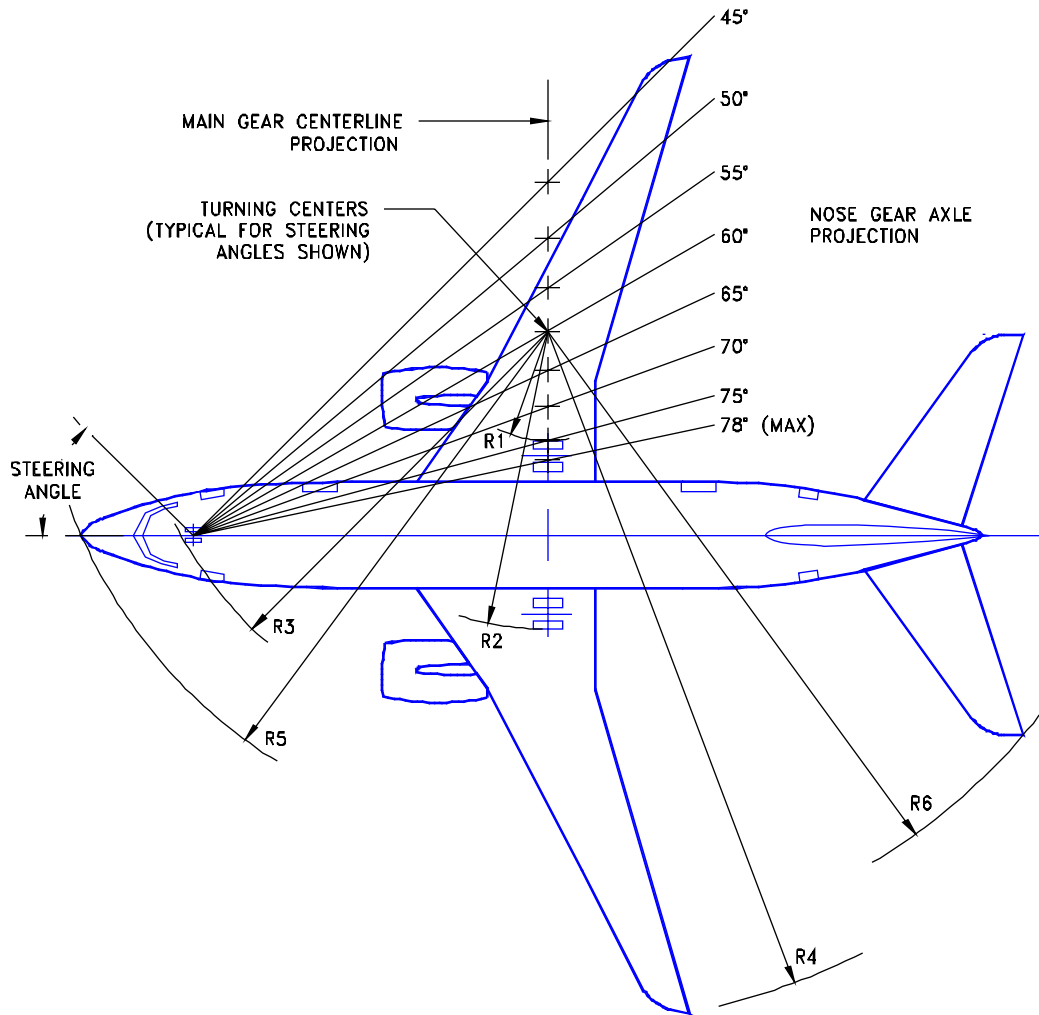

NOTES:

- * ACTUAL OPERATING TURNING RADII MAY BE GREATER THAN SHOWN
- * CONSULT WITH AIRLINE FOR SPECIFIC OPERATING PROCEDURE

STEERING ANGLE (DEGREES)	R1		R2		R3		R4		R5		R6	
	INNER GEAR		OUTER GEAR		NOSE GEAR		WING TIP		NOSE		TAIL	
	FT	M	FT	M	FT	M	FT	M	FT	M	FT	M
30	59.9	18.3	83.0	25.3	83.0	25.3	128.9	39.3	90.0	27.4	110.1	33.6
35	47.4	14.4	70.5	21.5	72.5	22.1	116.5	35.5	80.4	24.5	99.5	30.3
40	37.6	11.5	60.7	18.5	64.8	19.8	106.9	32.6	73.5	22.4	91.6	27.9
45	29.7	9.1	52.8	16.1	59.0	18.0	99.1	30.2	68.5	20.9	85.5	26.0
50	23.0	7.0	46.2	14.1	54.6	16.7	92.6	28.2	64.7	19.7	80.5	24.5
55	17.3	5.3	40.4	12.3	51.2	15.6	86.9	26.5	61.8	18.8	76.5	23.3
60	12.3	3.7	35.4	10.8	48.5	14.8	82.0	25.0	59.6	18.2	73.1	22.3
65	7.7	2.3	30.8	9.4	46.4	14.2	77.5	23.6	58.0	17.7	70.2	21.4
70	3.5	1.1	26.6	8.2	44.8	13.7	73.4	22.4	56.7	17.3	67.7	20.6
78 (MAX)	-2.8	-0.8	20.3	6.2	43.1	13.1	67.3	20.5	55.4	16.9	64.4	19.6

4.2.7 TURNING RADII - NO SLIP ANGLE

MODEL 737-700

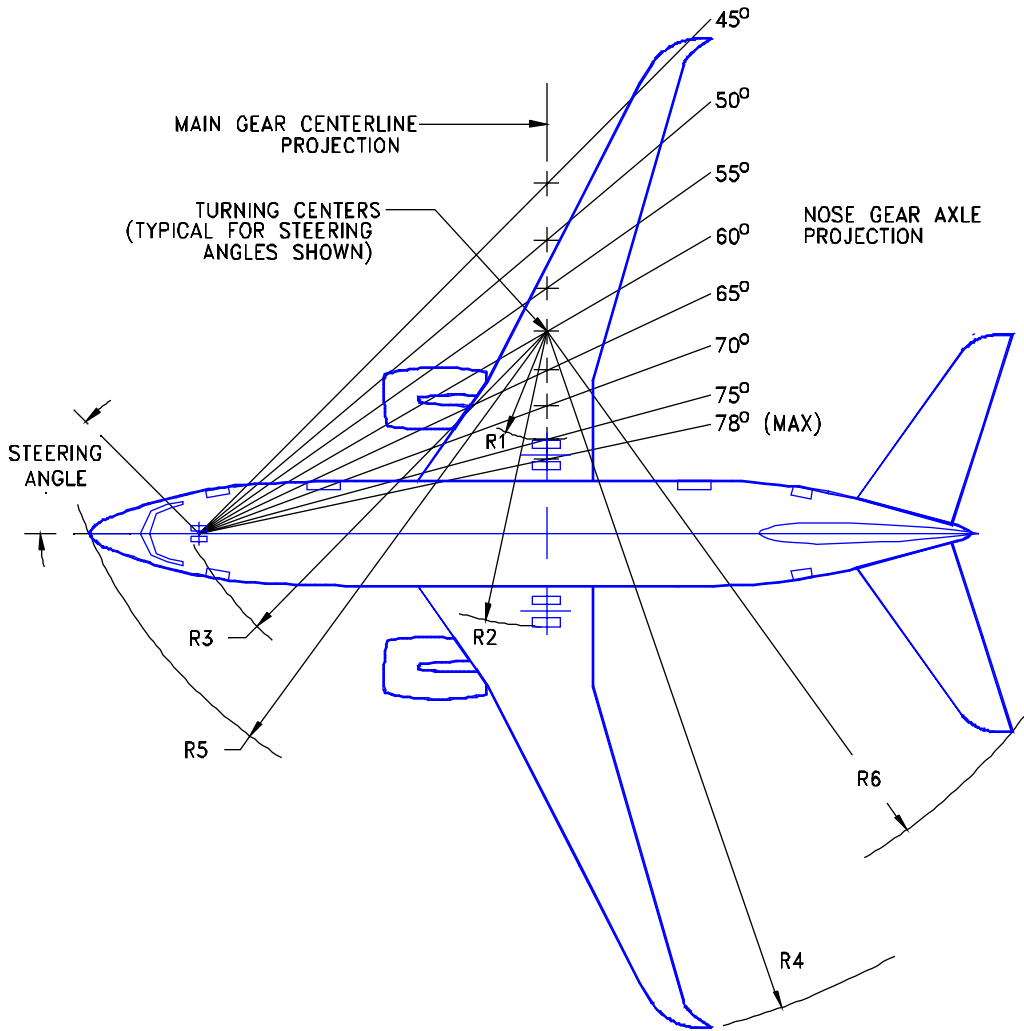

NOTES:

- * ACTUAL OPERATING TURNING RADII MAY BE GREATER THAN SHOWN
- * CONSULT WITH AIRLINE FOR SPECIFIC OPERATING PROCEDURE

STEERING ANGLE (DEGREES)	R1		R2		R3		R4		R5		R6	
	INNER GEAR		OUTER GEAR		NOSE GEAR		WING TIP		NOSE		TAIL	
	FT	M	FT	M	FT	M	FT	M	FT	M	FT	M
30	59.9	18.3	83.0	25.3	83.5	25.5	131.8	40.2	90.0	27.4	110.1	33.6
35	47.4	14.4	70.5	21.5	72.5	22.1	119.4	36.4	80.4	24.5	99.5	30.3
40	37.6	11.5	60.7	18.5	64.8	19.8	109.8	33.5	73.5	22.4	91.6	27.9
45	29.7	9.1	52.8	16.1	59.0	18.0	102.0	31.1	68.5	20.9	85.5	26.0
50	23.0	7.0	46.2	14.1	54.6	16.7	95.5	29.1	64.7	19.7	80.5	24.5
55	17.3	5.3	40.4	12.3	51.2	15.6	89.9	27.4	61.8	18.8	76.5	23.3
60	12.3	3.7	35.4	10.8	48.5	14.8	85.0	25.9	59.6	18.2	73.1	22.3
65	7.7	2.3	30.8	9.4	46.4	14.2	80.5	24.5	58.0	17.7	70.2	21.4
70	3.5	1.1	26.6	8.1	44.8	13.7	76.4	23.3	56.7	17.3	67.7	20.6
78 (MAX)	-2.8	-0.8	20.3	6.2	43.1	13.1	70.4	21.5	55.4	16.9	64.4	19.6

4.2.8 TURNING RADII - NO SLIP ANGLE

MODEL 737-700 WITH WINGLETS, 737 BBJ

D6-58325-6

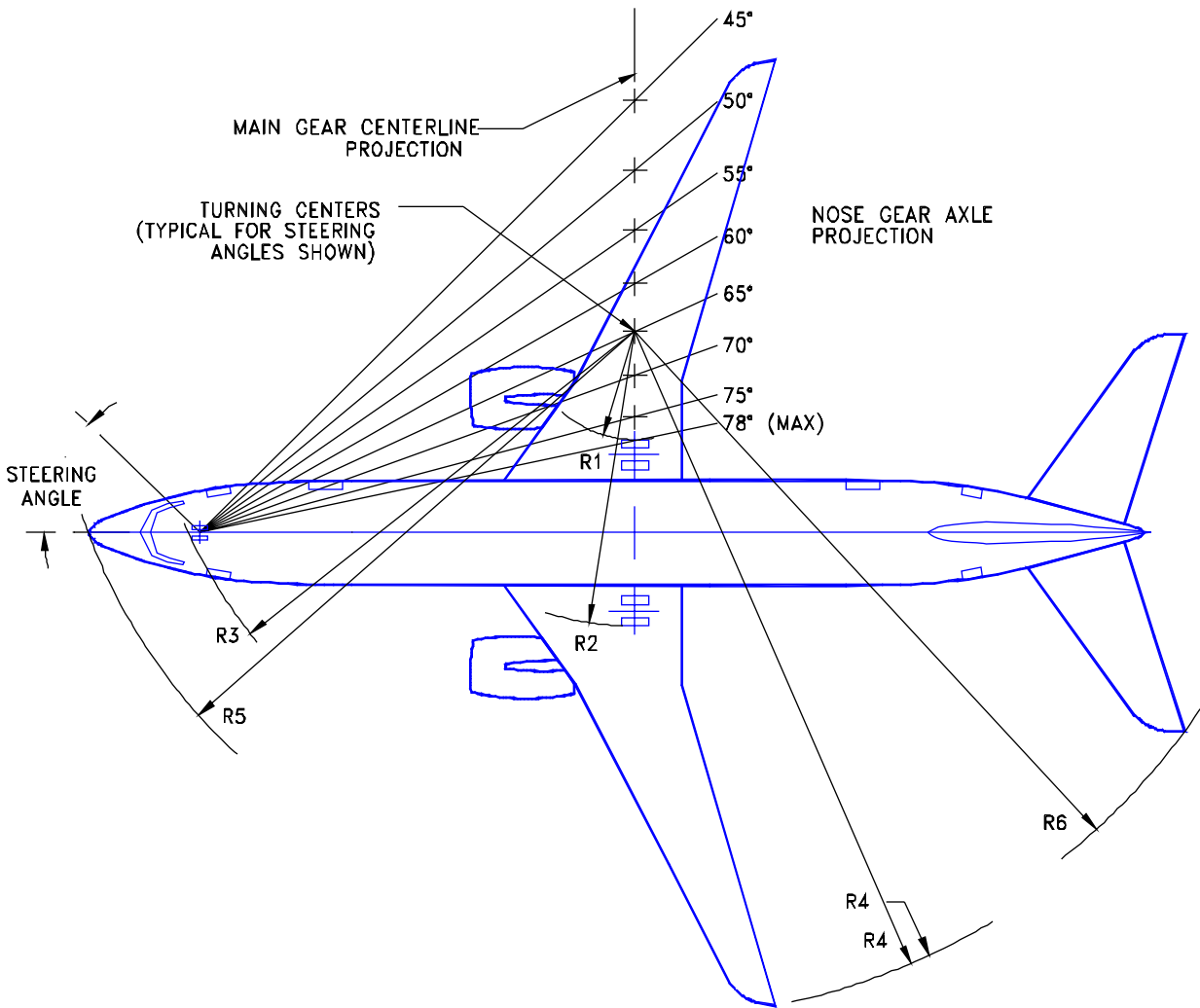

NOTES:

- * ACTUAL OPERATING TURNING RADII MAY BE GREATER THAN SHOWN
- * CONSULT WITH AIRLINE FOR SPECIFIC OPERATING PROCEDURE

STEERING ANGLE (DEGREES)	R1		R2		R3		R4		R5		R6	
	INNER GEAR		OUTER GEAR		NOSE GEAR		WING TIP		NOSE		TAIL	
	FT	M	FT	M	FT	M	FT	M	FT	M	FT	M
30	76.9	23.4	100.0	30.5	102.7	31.3	145.8	44.4	109.5	33.4	129.5	39.5
35	61.4	18.7	84.5	25.8	89.6	27.3	130.4	39.7	97.4	29.7	116.4	35.5
40	49.3	15.0	72.4	22.1	80.1	24.4	118.5	36.1	88.7	27.0	106.6	32.5
45	39.5	12.0	62.6	19.1	72.9	22.2	108.8	33.2	82.3	25.1	99.0	30.2
50	18.2	9.5	54.4	16.6	67.4	20.6	100.7	30.7	77.4	23.6	93.0	28.3
55	24.2	7.4	47.3	14.4	63.2	19.3	93.7	28.6	73.8	22.5	88.0	26.8
60	17.9	5.5	41.0	12.5	59.8	18.3	87.5	26.7	70.9	21.6	83.9	25.6
65	12.3	3.7	35.4	10.8	57.3	17.5	82.0	25.0	68.8	21.0	80.4	24.5
70	7.0	2.1	30.1	9.2	55.3	16.9	76.9	23.4	67.1	20.5	77.5	23.6
78 (MAX)	-0.7	-0.2	22.4	6.8	53.2	16.2	69.4	21.1	65.4	19.9	73.6	22.4

4.2.9 TURNING RADII - NO SLIP ANGLE

MODEL 737-800

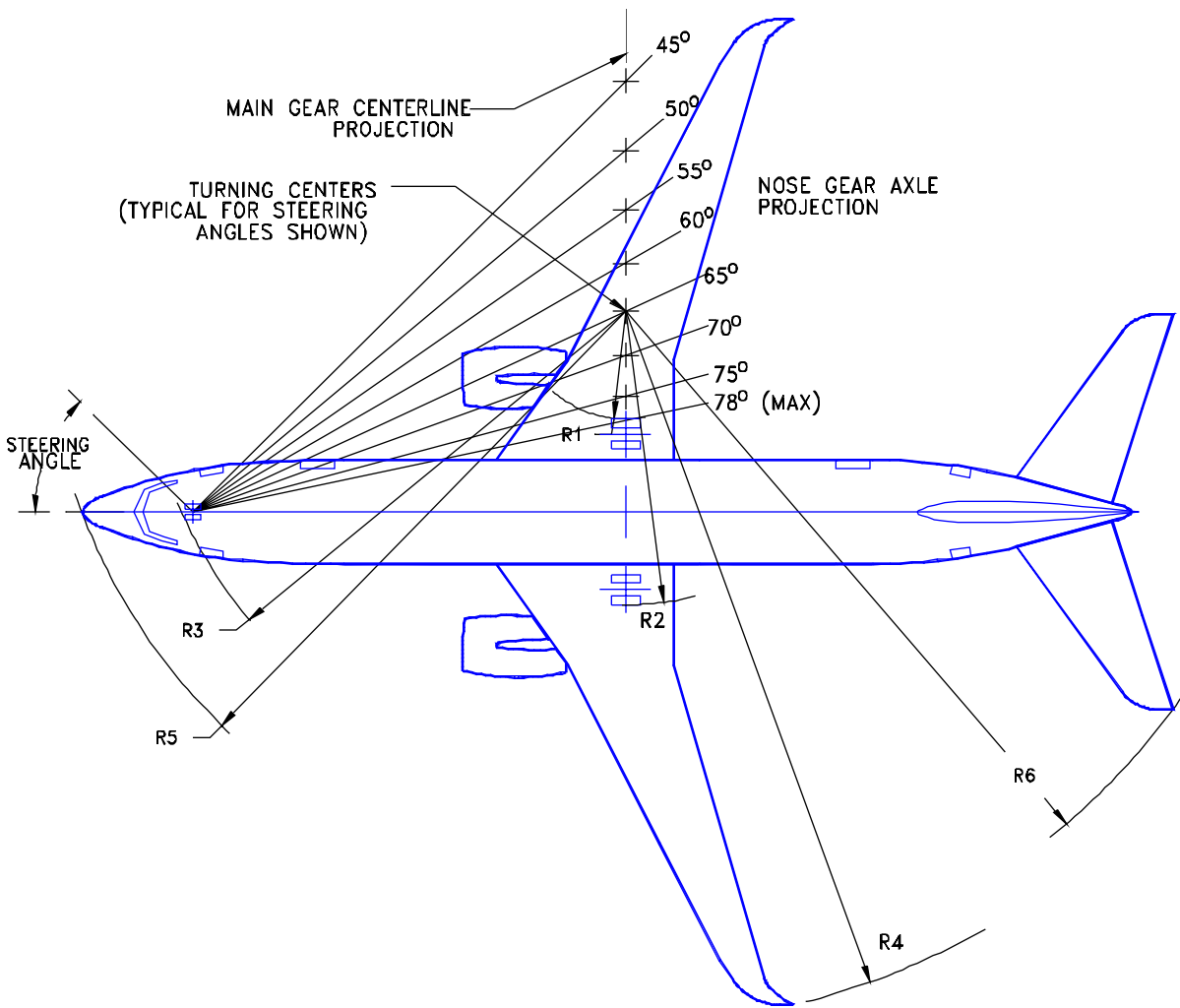

NOTES:

- * ACTUAL OPERATING TURNING RADII MAY BE GREATER THAN SHOWN
- * CONSULT WITH AIRLINE FOR SPECIFIC OPERATING PROCEDURE

STEERING ANGLE (DEGREES)	R1		R2		R3		R4		R5		R6	
	INNER GEAR		OUTER GEAR		NOSE GEAR		WING TIP		NOSE		TAIL	
	FT	M	FT	M	FT	M	FT	M	FT	M	FT	M
30	77.5	23.6	100.6	30.7	103.7	31.6	149.1	45.4	110.1	33.6	129.8	39.6
35	61.9	18.9	85.0	25.9	90.6	27.6	133.6	4.07	97.9	29.8	116.6	35.5
40	49.7	15.2	72.8	22.2	80.9	24.7	121.6	37.1	89.2	27.2	106.7	32.5
45	39.8	12.1	62.9	19.2	73.6	22.4	111.9	34.1	82.7	25.2	99.0	30.2
50	31.6	9.6	54.7	16.7	68.0	20.7	103.8	31.6	77.8	23.7	92.9	28.3
55	24.4	7.4	47.5	14.5	63.7	19.43	96.8	29.5	74.1	22.6	87.9	26.8
60	18.1	5.5	41.2	12.6	60.3	18.4	90.6	27.6	71.3	21.7	83.8	25.5
65	12.4	3.8	35.8	10.8	57.7	17.6	85.1	25.9	69.1	21.1	80.3	24.5
70	7.2	2.2	30.3	9.2	55.6	17.0	80.0	24.4	67.4	20.6	77.3	23.6
78 (MAX)	-0.6	-0.2	22.5	6.9	53.5	16.3	72.5	22.1	65.7	20.0	73.3	22.3

4.2.10 TURNING RADII - NO SLIP ANGLE
MODEL 737-800 WITH WINGLETS, 737 BBJ2

D6-58325-6

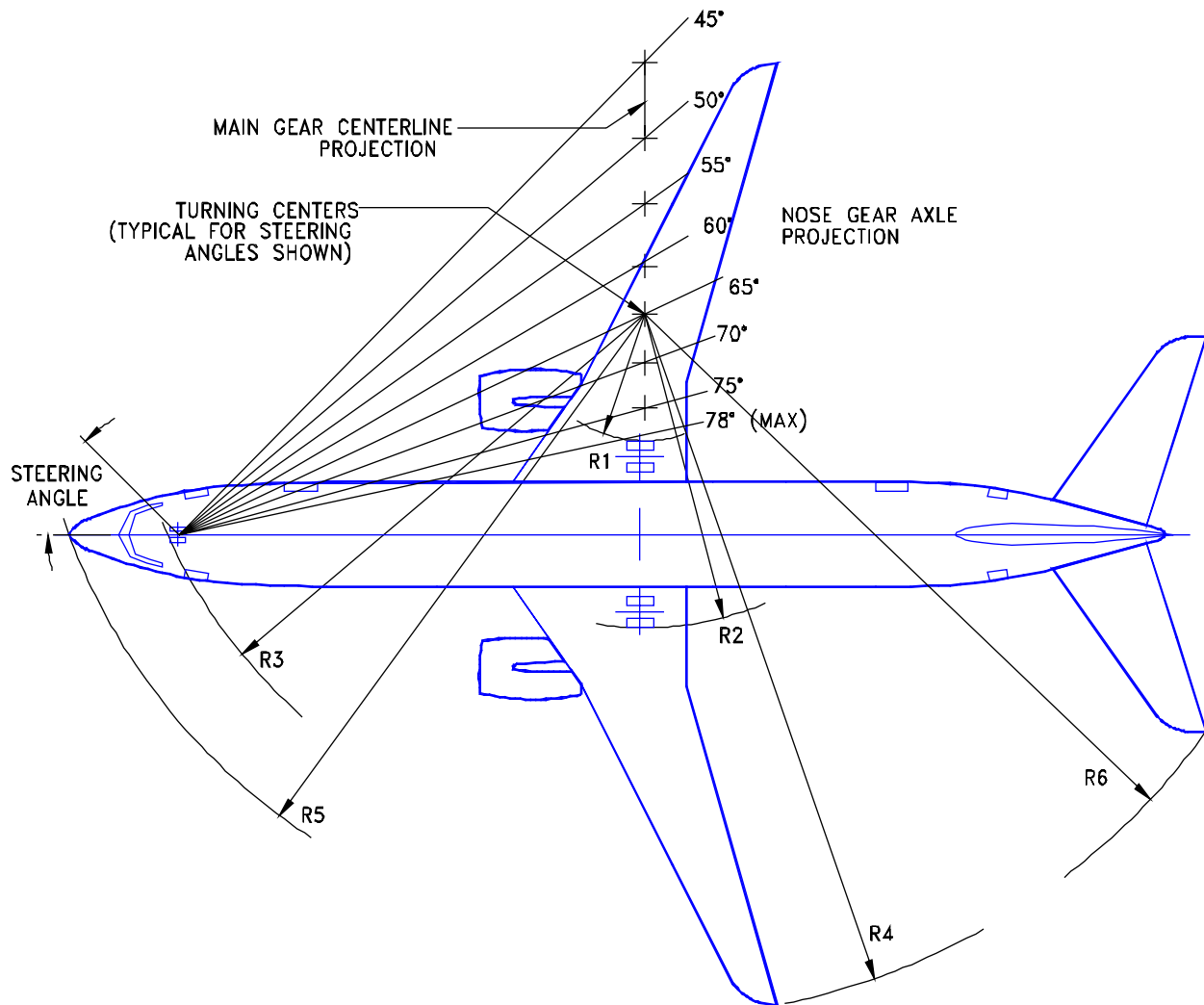

NOTES:

* ACTUAL OPERATING TURNING RADII MAY BE GREATER THAN SHOWN

* CONSULT WITH AIRLINE FOR SPECIFIC OPERATING PROCEDURE

STEERING ANGLE (DEGREES)	R1		R2		R3		R4		R5		R6	
	INNER GEAR		OUTER GEAR		NOSE GEAR		WING TIP		NOSE		TAIL	
	FT	M	FT	M	FT	M	FT	M	FT	M	FT	M
30	86.0	26.2	109.1	33.2	113.5	34.6	154.8	47.2	119.9	36.5	138.8	42.3
35	68.9	21.0	92.0	28.0	99.1	30.2	137.8	42.0	106.4	32.4	124.1	37.8
40	55.5	16.9	78.6	24.0	88.5	27.0	124.6	38.0	96.7	29.5	113.2	34.5
45	44.7	13.6	67.8	20.7	80.6	24.6	113.9	34.7	89.6	27.3	104.8	31.9
50	35.7	10.9	58.8	17.9	74.4	22.7	105.0	32.0	84.2	25.7	98.0	29.9
55	27.9	8.9	51.0	15.5	69.7	21.2	97.3	29.7	80.1	24.4	92.5	28.2
60	21.0	6.4	44.1	13.4	66.0	20.1	90.5	27.6	76.9	23.4	88.0	26.9
65	14.7	4.5	37.8	11.5	63.1	19.2	84.4	25.7	74.5	22.7	84.1	25.6
70	8.9	2.7	32.0	9.8	60.9	18.6	78.7	24.0	72.6	22.1	80.8	24.6
78 (MAX)	0.4	0.1	23.5	7.2	58.5	17.8	70.4	21.5	70.7	21.5	76.5	23.4

4.2.11 TURNING RADII - NO SLIP ANGLE

MODEL 737-900, -900ER

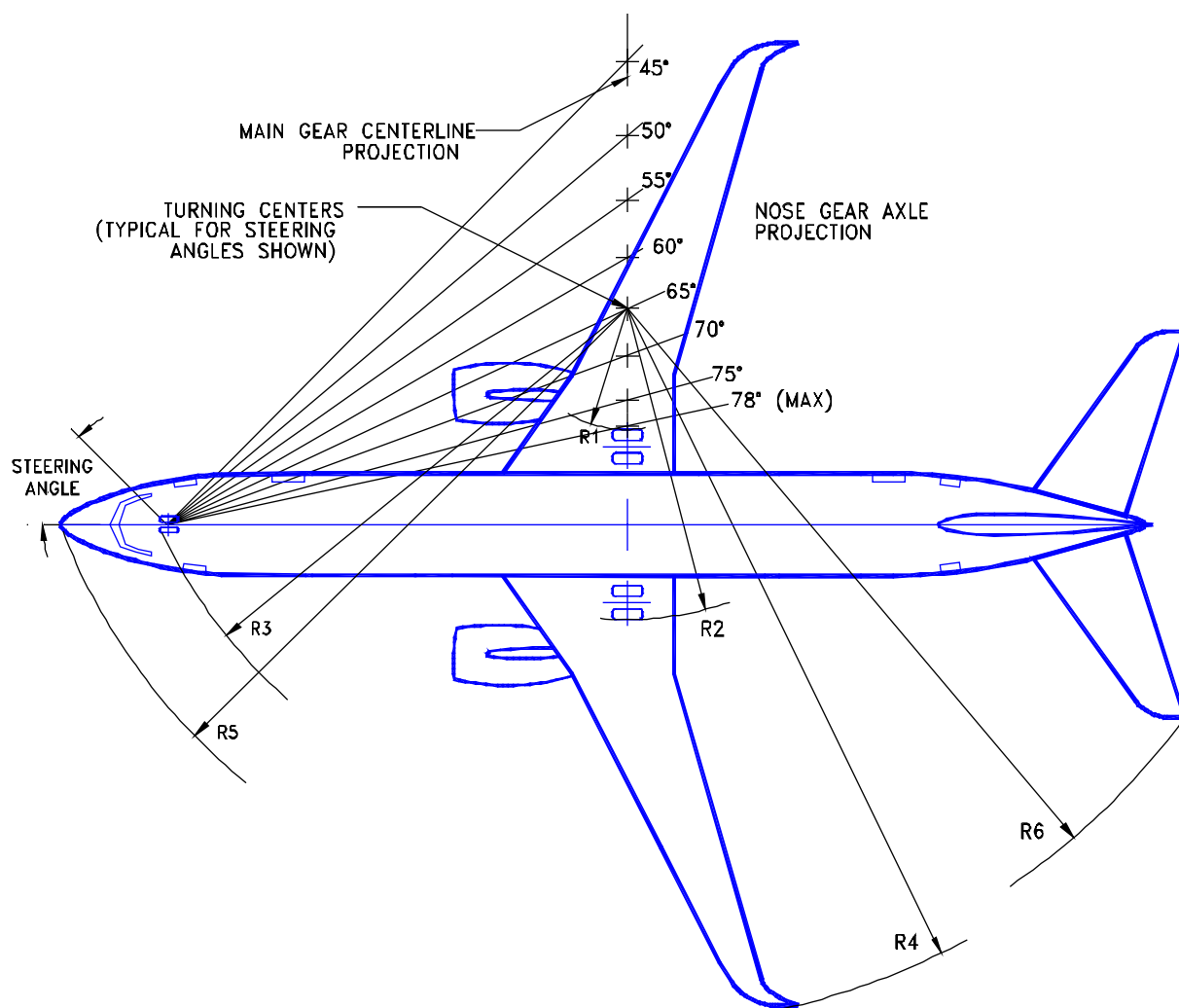

NOTES:

- * ACTUAL OPERATING TURNING RADII MAY BE GREATER THAN SHOWN
- * CONSULT WITH AIRLINE FOR SPECIFIC OPERATING PROCEDURE

STEERING ANGLE (DEGREES)	R1		R2		R3		R4		R5		R6	
	INNER GEAR		OUTER GEAR		NOSE GEAR		WING TIP		NOSE		TAIL	
	FT	M	FT	M	FT	M	FT	M	FT	M	FT	M
30	86.0	26.2	109.1	33.2	113.5	34.6	157.6	48.0	119.9	36.5	138.8	42.3
35	68.9	21.0	92.0	28.0	99.1	30.2	140.6	42.9	106.4	32.4	124.1	37.8
40	55.5	16.9	78.6	24.0	88.5	27.0	127.5	38.8	96.7	29.5	113.2	34.5
45	44.7	13.6	67.8	20.7	80.6	24.6	118.8	35.6	89.6	27.3	104.8	31.9
50	35.7	10.9	58.8	17.9	74.4	22.7	107.9	32.9	84.2	25.7	98.0	29.9
55	27.9	8.9	51.0	15.5	69.7	21.2	100.2	30.6	80.1	24.4	92.5	28.2
60	21.0	6.4	44.1	13.4	66.0	20.1	93.5	28.5	76.9	23.4	88.0	26.9
65	14.7	4.5	37.8	11.5	63.1	19.2	87.4	26.6	74.5	22.7	84.1	25.6
70	8.9	2.7	32.0	9.8	60.9	18.6	81.8	24.9	72.6	22.1	80.8	24.6
78 (MAX)	0.4	0.1	23.5	7.2	58.5	17.8	73.6	22.4	70.7	21.5	76.5	23.4

4.2.12 TURNING RADII - NO SLIP ANGLE

MODEL 737-900, -900ER WITH WINGLETS

D6-58325-6

NOTES:

- 3° TIRE SLIP ANGLE APPROXIMATE ONLY FOR 78° STEERING ANGLE
- CONSULT WITH AIRLINE FOR ACTUAL OPERATING DATA
- DIMENSIONS ROUNDED TO NEAREST 0.1 FT AND 0.1 METER

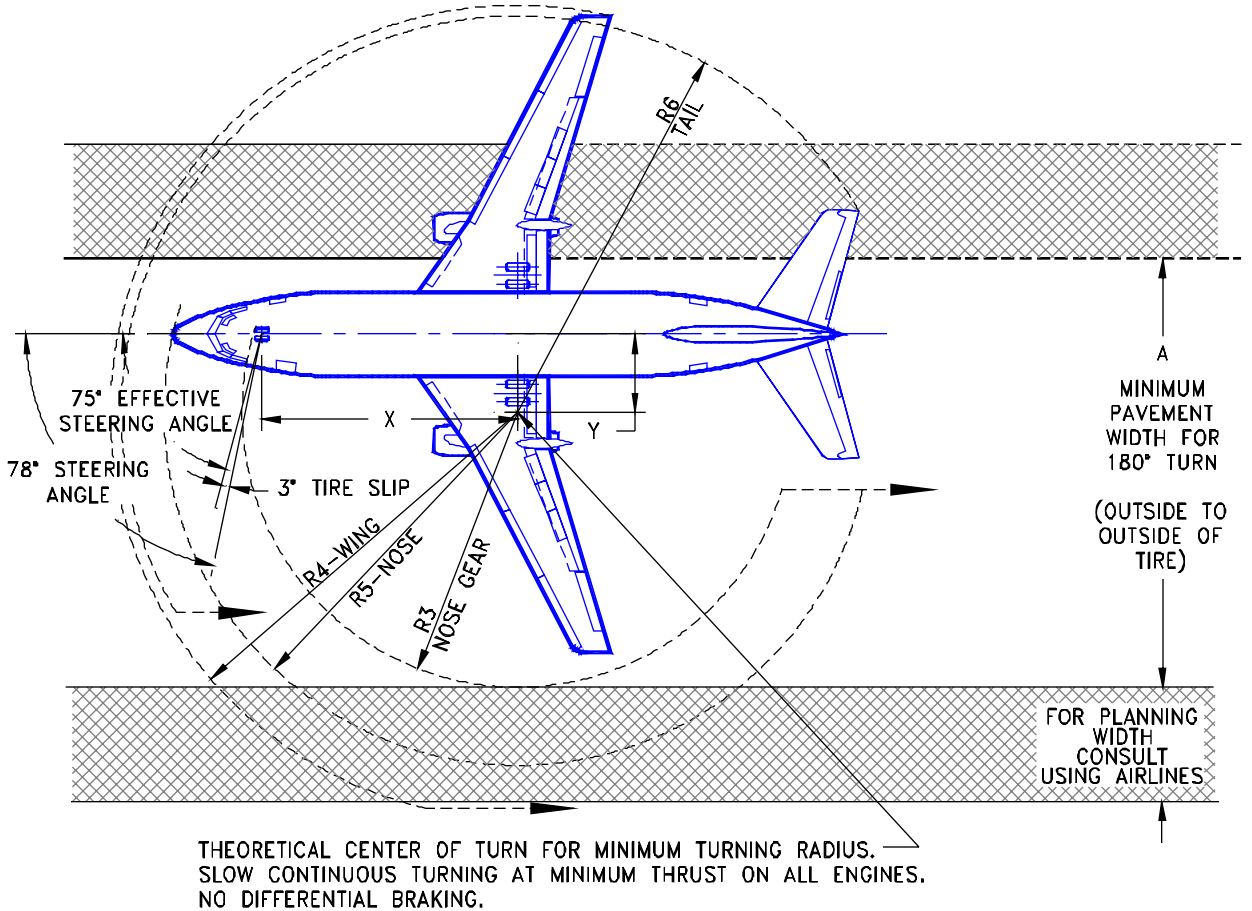

AIRPLANE MODEL	EFFECTIVE TURNING ANGLE (DEG)	X		Y		A		R3		R4		R5		R6	
		FT	M	FT	M	FT	M	FT	M	FT	M	FT	M	FT	M
737-100	75	34.3	10.5	9.2	2.8	56.1	17.1	36.5	11.1	57.2	17.4	48.2	14.7	54.0	16.5
737-200	75	41.3	11.4	10.0	3.0	60.0	18.3	39.6	12.1	58.0	17.7	51.3	15.6	57.0	18.3

4.3.1 MINIMUM TURNING RADII - 3° SLIP ANGLE
 MODEL 737-100, -200

NOTES:

- 3° TIRE SLIP ANGLE APPROXIMATE ONLY FOR 78° STEERING ANGLE
- CONSULT WITH AIRLINE FOR ACTUAL OPERATING DATA
- DIMENSIONS ROUNDED TO NEAREST 0.1 FT AND 0.1 METER

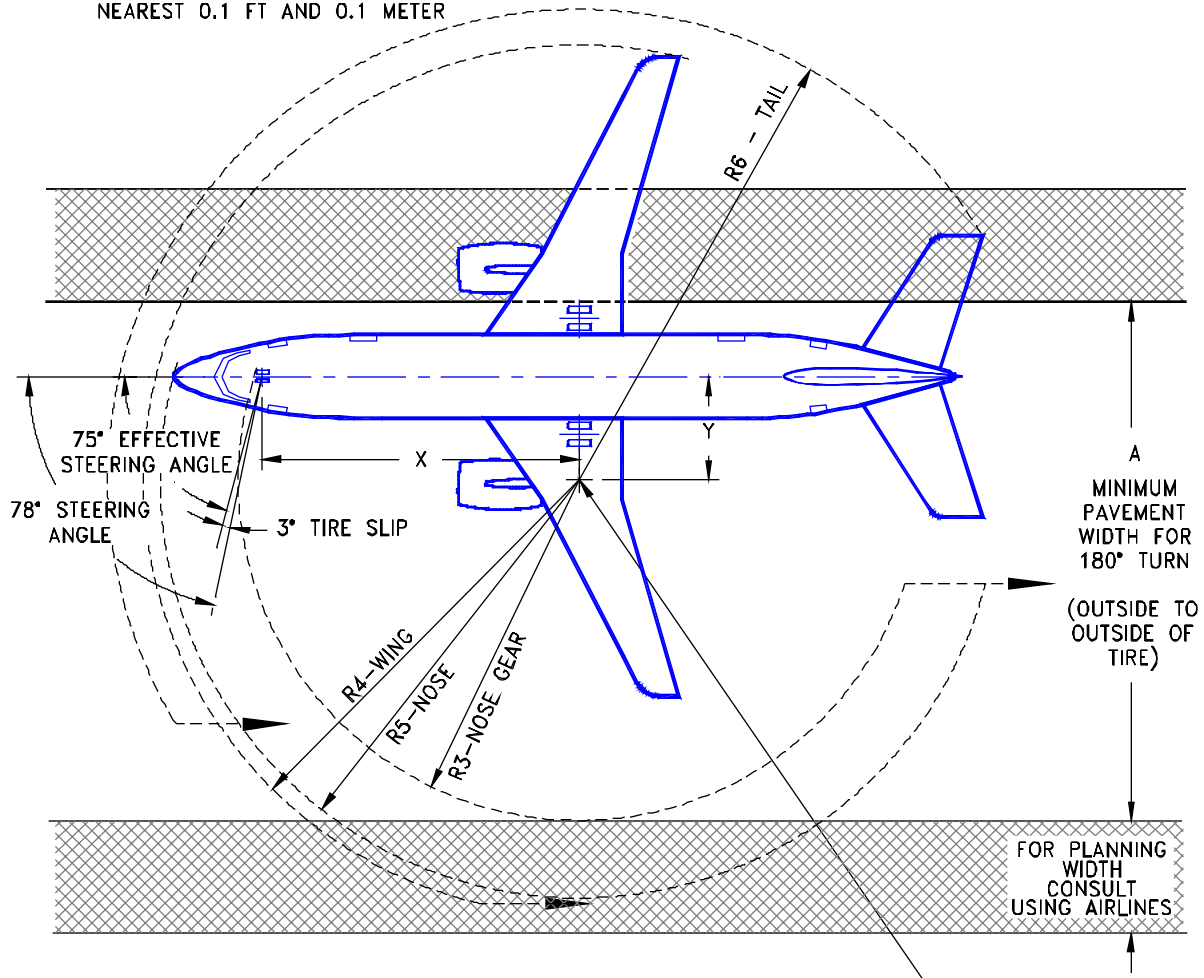

THEORETICAL CENTER OF TURN FOR MINIMUM TURNING RADIUS.
SLOW CONTINUOUS TURNING AT MINIMUM THRUST ON ALL ENGINES.
NO DIFFERENTIAL BRAKING.

AIRPLANE MODEL	EFFECTIVE TURNING ANGLE (DEG)	X		Y		A		R3		R4		R5		R6	
		FT	M	FT	M	FT	M	FT	M	FT	M	FT	M	FT	M
737-300	75	40.8	12.4	10.9	3.3	64.6	19.7	43.2	13.2	60.2	18.4	55.1	16.8	64.0	19.5
737-300 WITH WINGLETS	75	40.8	12.4	10.9	3.3	64.6	19.7	43.2	13.2	65.4	19.9	55.1	16.8	64.0	19.5
737-400	75	46.8	14.3	12.5	3.8	72.4	22.1	49.4	15.1	61.8	18.8	61.3	18.7	68.3	20.8
737-500	75	36.3	11.1	9.7	3.0	58.7	17.9	38.5	11.7	59.1	18.0	50.4	15.4	60.6	18.5

4.3.2 MINIMUM TURNING RADII - 3° SLIP ANGLE

MODEL 737-300, -300 WITH WINGLETS, -400, -500

D6-58325-6

NOTES:

- 3° TIRE SLIP ANGLE APPROXIMATE ONLY FOR 78° STEERING ANGLE
- CONSULT WITH AIRLINE FOR ACTUAL OPERATING DATA
- DIMENSIONS ROUNDED TO NEAREST 0.1 FT AND 0.1 METER

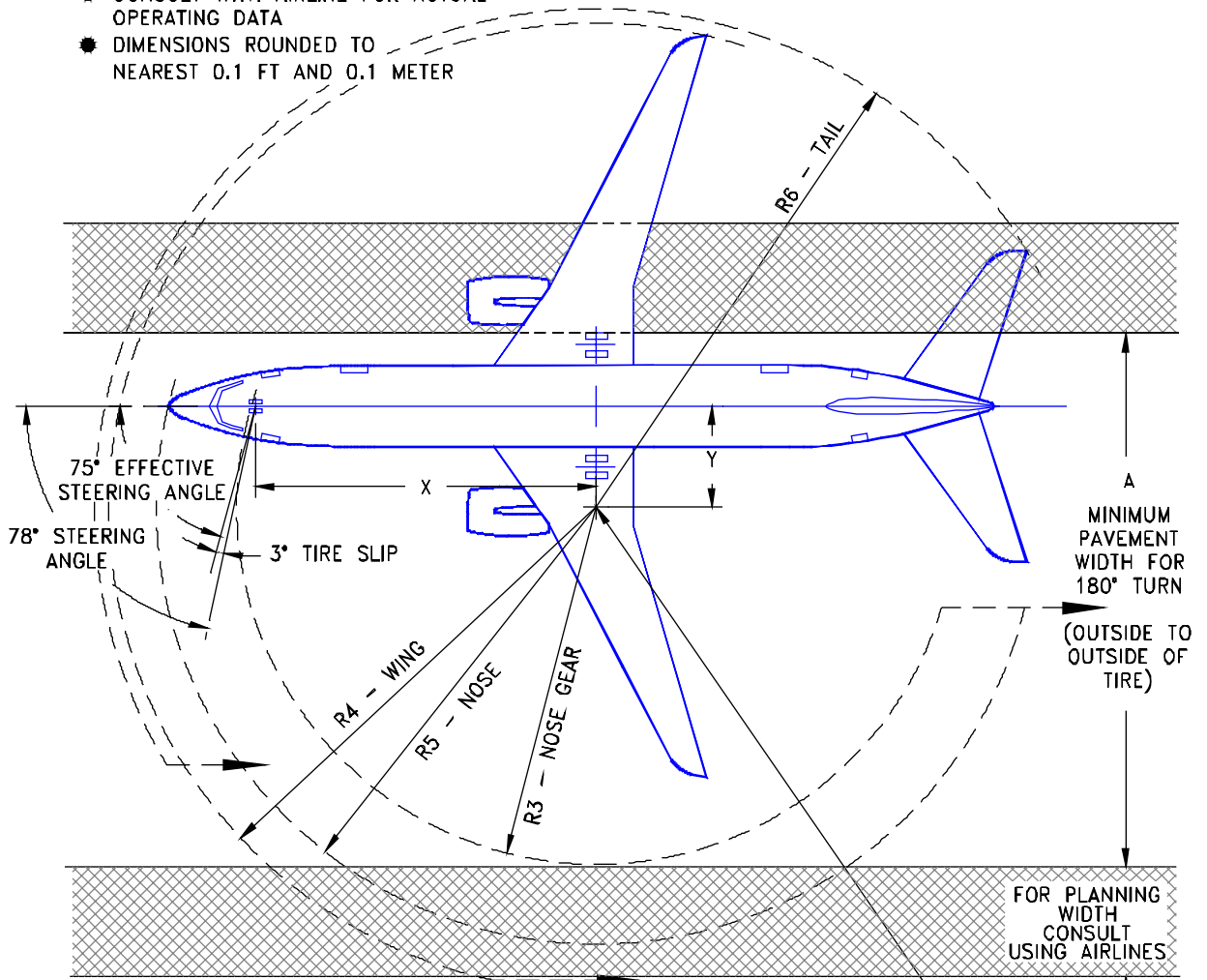

THEORETICAL CENTER OF TURN FOR MINIMUM TURNING RADIUS. SLOW CONTINUOUS TURNING AT MINIMUM THRUST ON ALL ENGINES. NO DIFFERENTIAL BRAKING.

AIRPLANE MODEL	EFFECTIVE TURNING ANGLE (DEG)	X		Y		A		R3		R4		R5		R6	
		FT	M	FT	M	FT	M	FT	M	FT	M	FT	M	FT	M
737-600	75	36.8	11.2	9.9	3.0	60.8	18.5	39.3	12.0	68.5	20.9	51.5	15.7	61.9	18.9
737-700	75	41.3	12.6	11.1	3.4	66.4	20.3	43.8	13.3	69.6	21.2	55.9	17.0	65.5	20.0
737-800	75	51.2	15.6	13.7	4.2	79.1	24.1	53.8	16.4	72.1	22.0	65.9	20.1	74.9	22.8
737-900, -900ER	75	56.3	17.2	15.0	4.6	85.9	26.2	59.2	18.1	73.5	22.4	71.3	21.7	78.0	23.8

4.3.3 MINIMUM TURNING RADII - 3° SLIP ANGLE

MODEL 737-600, -700, -800, -900, -900ER

NOTES:

- 3° TIRE SLIP ANGLE APPROXIMATE ONLY FOR 78° STEERING ANGLE
- CONSULT WITH AIRLINE FOR ACTUAL OPERATING DATA
- DIMENSIONS ROUNDED TO NEAREST 0.1 FT AND 0.1 METER

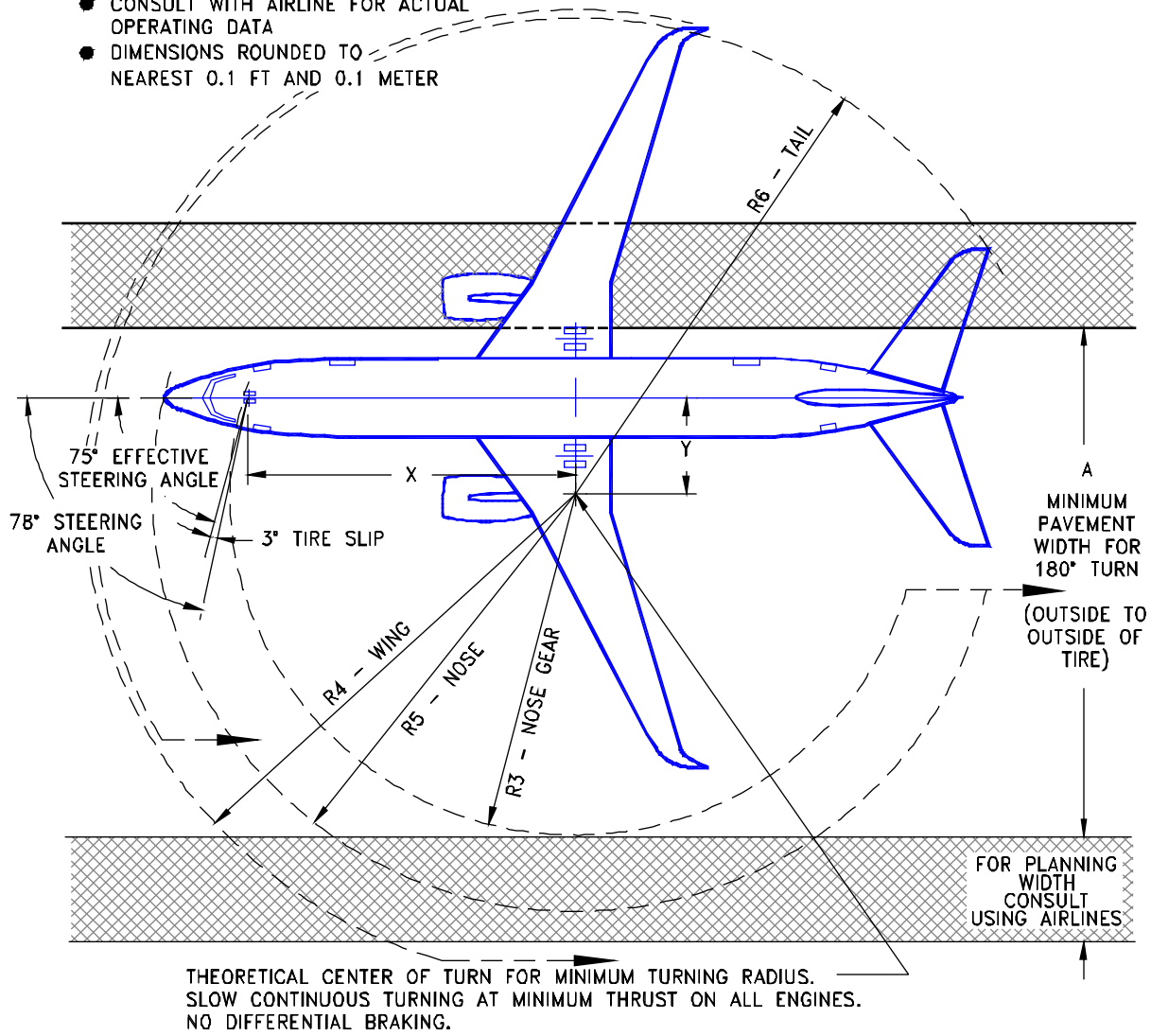

AIRPLANE MODEL	EFFECTIVE TURNING ANGLE (DEG)	X		Y		A		R3		R4		R5		R6	
		FT	M	FT	M	FT	M	FT	M	FT	M	FT	M	FT	M
737-600	75	37.1	11.3	9.9	3.0	60.8	18.5	39.4	12.0	71.6	21.8	51.5	15.7	61.9	18.9
737-700 737BBJ	75	41.3	12.6	11.1	3.4	66.7	20.3	44.1	13.3	72.6	22.1	55.9	17.0	65.5	20.0
737-800 737 BBJ2	75	51.2	15.6	13.7	4.2	79.6	24.1	54.4	16.4	75.2	22.9	65.9	20.1	74.9	22.8
737-900, -900ER	75	56.3	17.2	15.1	4.6	86.2	26.2	59.6	18.1	76.6	23.3	71.3	21.7	78.0	23.8

4.3.4 MINIMUM TURNING RADII - 3° SLIP ANGLE

MODEL 737-600, -700, -800, -900, -900ER WITH WINGLETS, 737 BBJ, 737 BBJ2

DRAWING
NOT TO SCALE

NOT TO BE USED
FOR LANDING
APPROACH VISIBILITY

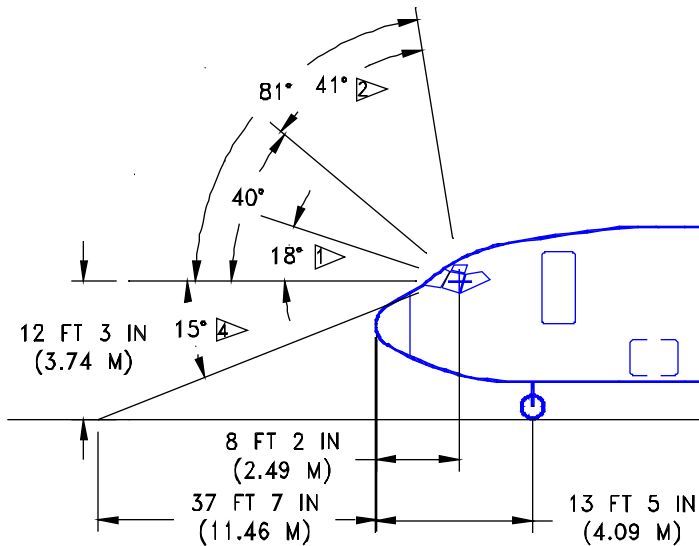

VISUAL ANGLES IN PLANE PARALLEL
TO LONGITUDINAL AXIS THROUGH
PILOT'S EYE POSITION

NOTES: HEAD ROTATED ABOUT POINT
3.3 IN (0.08 M) AFT OF
PILOT'S EYE POSITION.

- ① UPWARD VISION THROUGH
MAIN WINDOW
- ② VISION THROUGH EYEBROW
WINDOW
- ③ WITH HEAD MOVED
5 IN (0.13 M) OUTBOARD
- ④ DOWNWARD VISION THROUGH
MAIN WINDOW

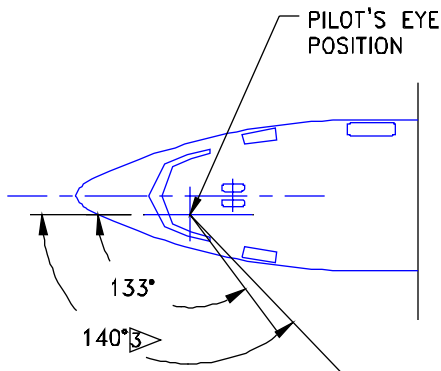

VISUAL ANGLES IN HORIZONTAL PLANE
THROUGH PILOT'S EYE POSITION

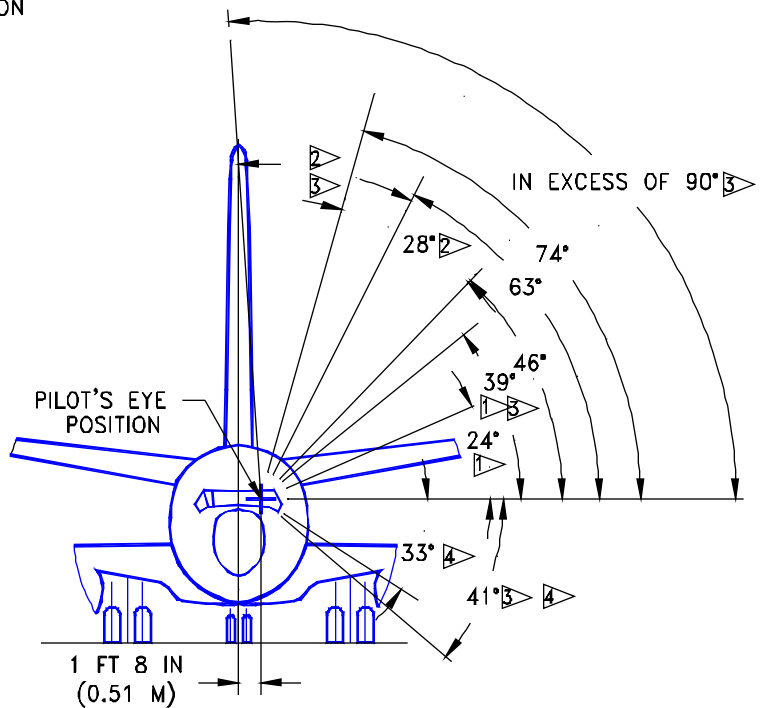

VISUAL ANGLES IN PLANE PERPENDICULAR
TO LONGITUDINAL AXIS THROUGH
PILOT'S EYE POSITION

4.4 VISIBILITY FROM COCKPIT IN STATIC POSITION
MODEL 737, ALL MODELS

NOTE:
 BEFORE DETERMINING THE SIZE OF THE
 INTERSECTION FILLET, CHECK WITH THE
 AIRLINES REGARDING THE OPERATING
 PROCEDURES THAT THEY USE AND THE TYPES
 OF AIRCRAFT THAT ARE EXPECTED TO
 SERVE THE AIRPORT.

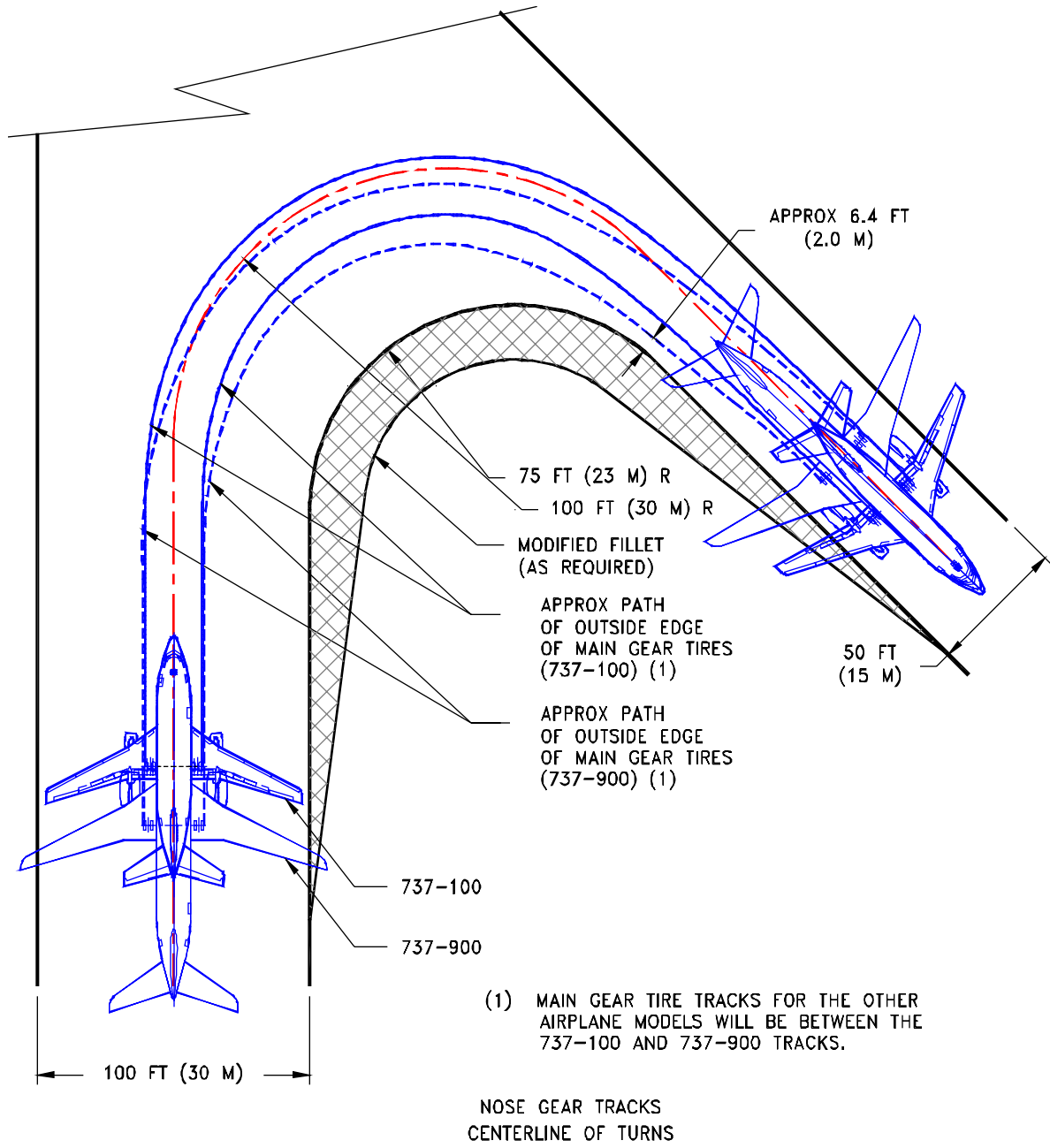

**4.5.1 RUNWAY AND TAXIWAY TURN PATHS - RUNWAY-TO-TAXIWAY,
 MORE THAN 90 DEGREES, NOSE GEAR TRACKS CENTERLINE
 MODEL 737, ALL MODELS**

NOTE:
 BEFORE DETERMINING THE SIZE OF THE
 INTERSECTION FILLET, CHECK WITH THE
 AIRLINES REGARDING THE OPERATING
 PROCEDURES THAT THEY USE AND THE
 TYPES OF AIRCRAFT THAT ARE EXPECTED
 TO SERVE THE AIRPORT.

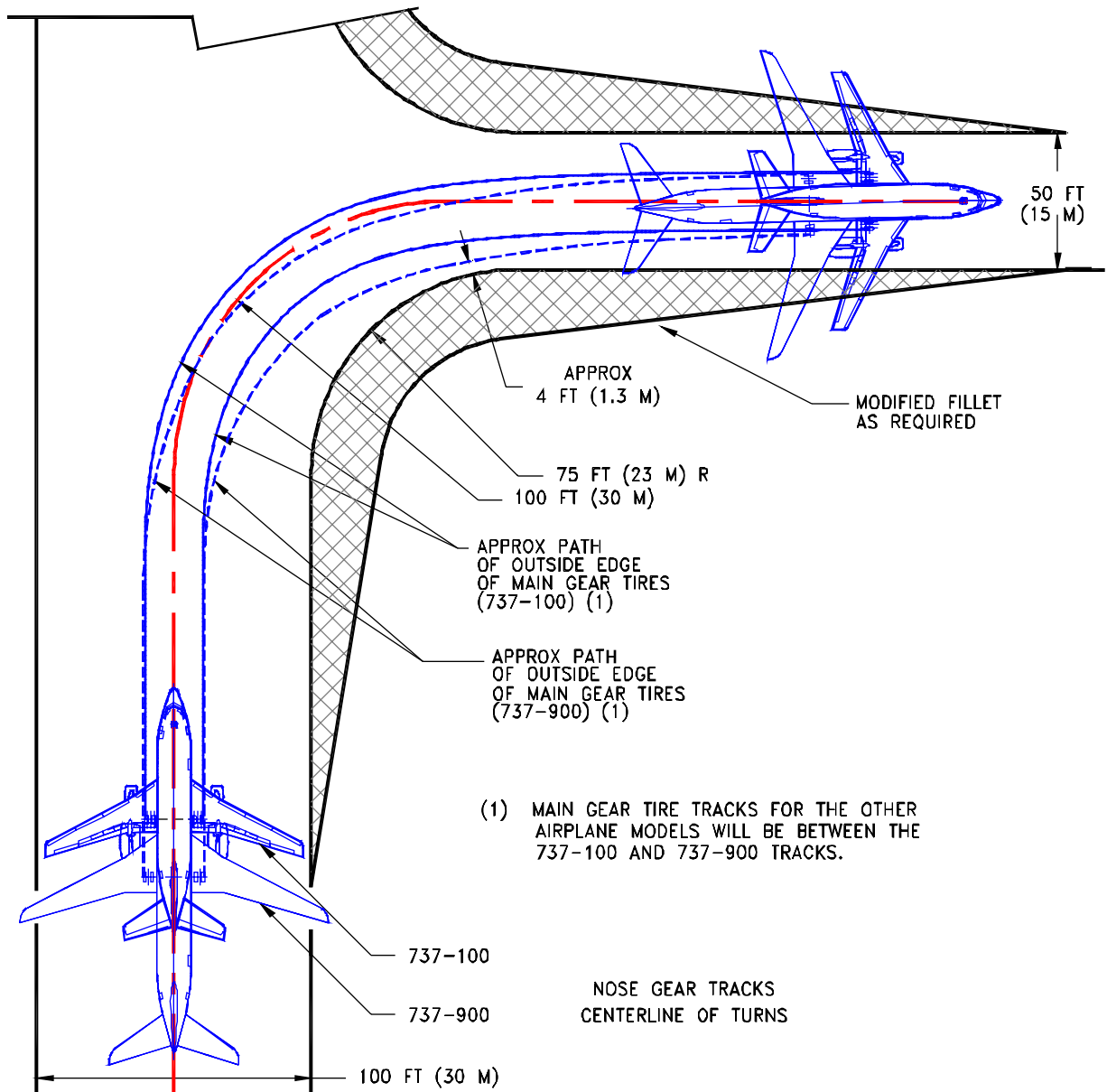

**4.5.2 RUNWAY AND TAXIWAY TURN PATHS - RUNWAY-TO-TAXIWAY,
 90 DEGREES, NOSE GEAR TRACKS CENTERLINE**
MODEL 737, ALL MODELS

NOTE:
 BEFORE DETERMINING THE SIZE OF THE
 INTERSECTION FILLET, CHECK WITH THE
 AIRLINES REGARDING THE OPERATING
 PROCEDURES THAT THEY USE AND THE TYPES
 OF AIRCRAFT THAT ARE EXPECTED TO
 SERVE THE AIRPORT.

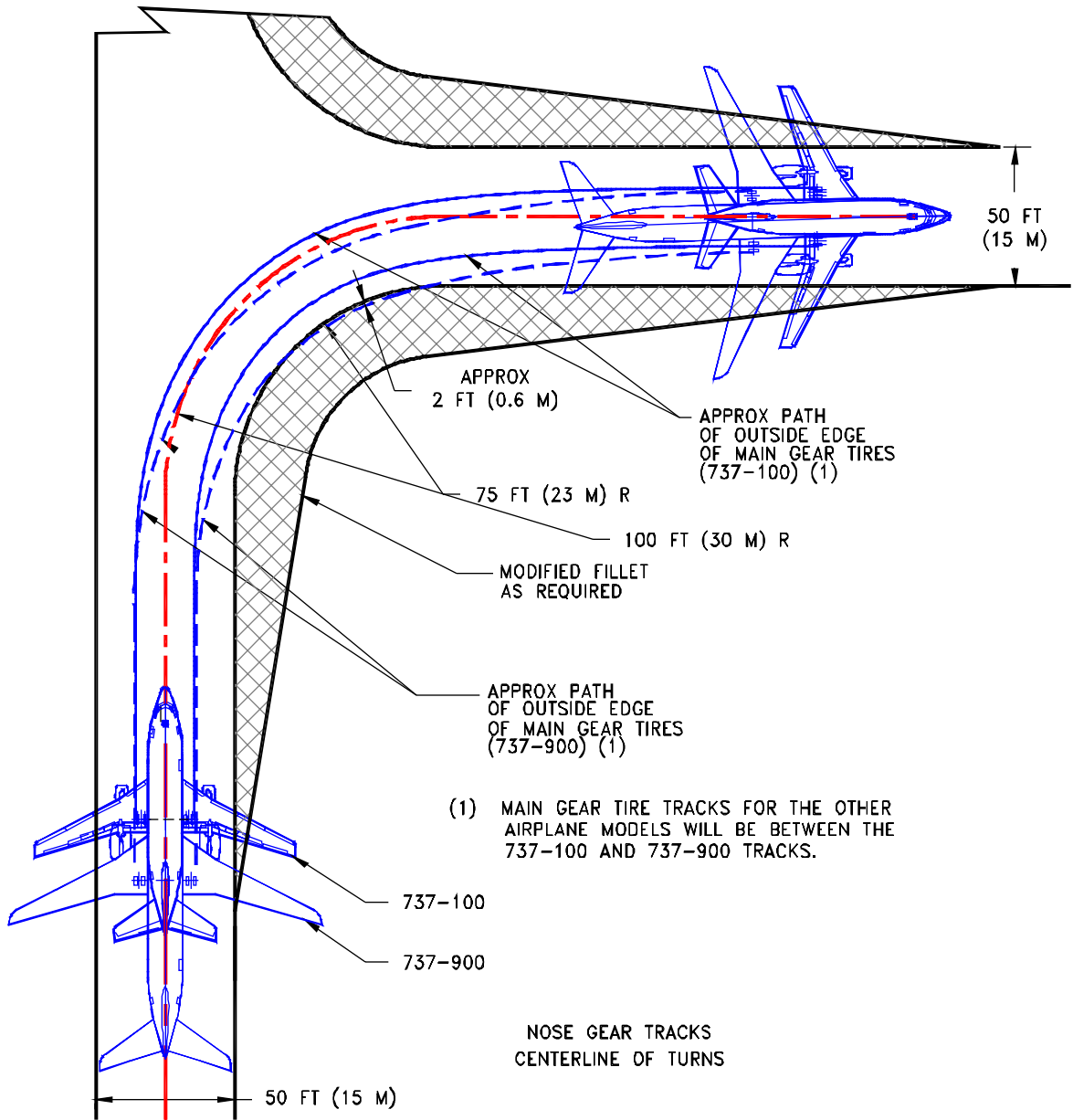

**4.5.3 RUNWAY AND TAXIWAY TURN PATHS - TAXIWAY-TO-TAXIWAY,
 90 DEGREES, NOSE GEAR TRACKS CENTERLINE**
MODEL 737, ALL MODELS

D6-58325-6

NOTE:
 BEFORE DETERMINING THE SIZE OF THE
 INTERSECTION FILLET, CHECK WITH THE
 AIRLINES REGARDING THE OPERATING
 PROCEDURES THAT THEY USE AND THE TYPES
 OF AIRCRAFT THAT ARE EXPECTED TO
 SERVE THE AIRPORT.

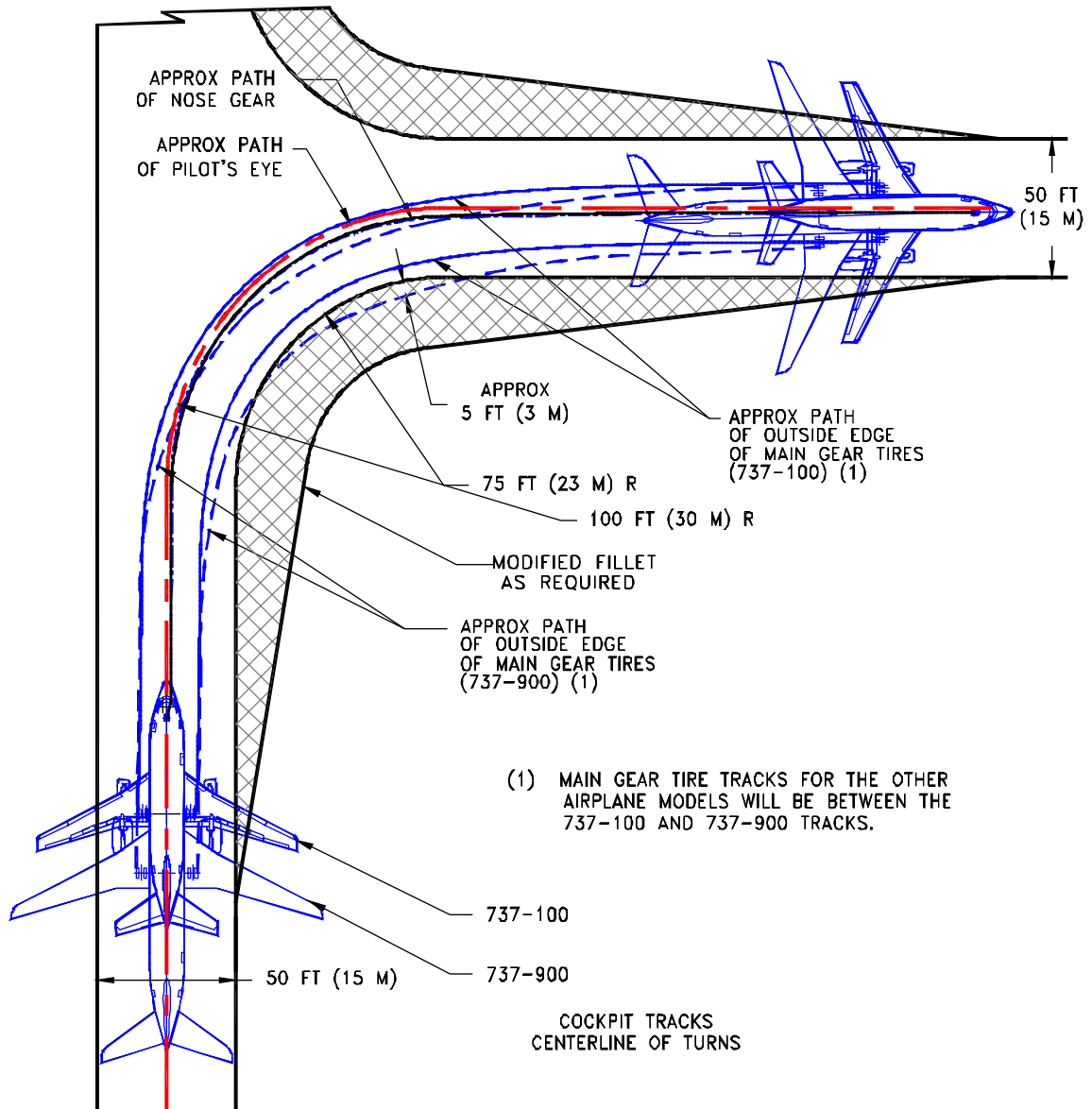

**4.5.4 RUNWAY AND TAXIWAY TURN PATHS - TAXIWAY-TO-TAXIWAY,
 90 DEGREES, COCKPIT TRACKS CENTERLINE**
 MODEL 737, ALL MODELS

D6-58325-6

NOTE:
 BEFORE DETERMINING THE SIZE OF THE PAVEMENT AND SHOULDER, CHECK WITH THE AIRLINES REGARDING THE OPERATING PROCEDURES THAT THEY USE AND THE AIRCRAFT TYPES THAT ARE EXPECTED TO SERVE THE AIRPORT.

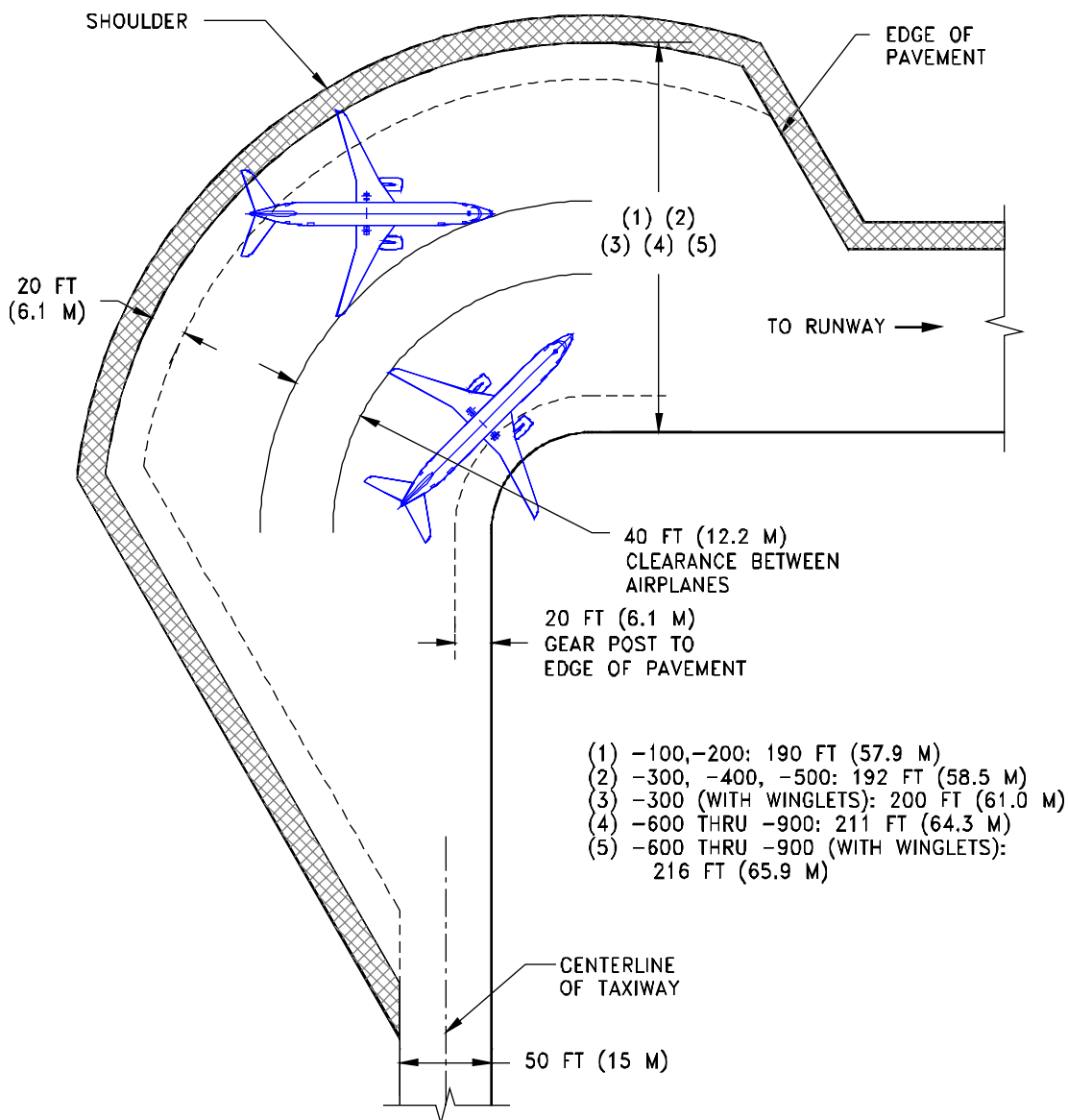

4.6. RUNWAY HOLDING BAY
 MODEL 737, ALL MODELS

5.0 TERMINAL SERVICING

5.1 Airplane Servicing Arrangement - Typical Turnaround

5.2 Terminal Operations - Turnaround Station

5.3 Terminal Operations - En Route Station

5.4 Ground Servicing Connections

5.5 Engine Starting Pneumatic Requirements

5.6 Ground Pneumatic Power Requirements

5.7 Conditioned Air Requirements

5.8 Ground Towing Requirements

5.0 TERMINAL SERVICING

During turnaround at the terminal, certain services must be performed on the aircraft, usually within a given time, to meet flight schedules. This section shows service vehicle arrangements, schedules, locations of service points, and typical service requirements. The data presented in this section reflect ideal conditions for a single airplane. Service requirements may vary according to airplane condition and airline procedure.

Section 5.1 shows typical arrangements of ground support equipment during turnaround. As noted, if the auxiliary power unit (APU) is used, the electrical, air start, and air-conditioning service vehicles would not be required. Passenger loading bridges or portable passenger stairs could be used to load or unload passengers.

Sections 5.2 and 5.3 show typical service times at the terminal. These charts give typical schedules for performing service on the airplane within a given time. Service times could be rearranged to suit availability of personnel, airplane configuration, and degree of service required.

Section 5.4 shows the locations of ground service connections in graphic and in tabular forms. Typical capacities and service requirements are shown in the tables. Services with requirements that vary with conditions are described in subsequent sections.

Section 5.5 shows typical sea level air pressure and flow requirements for starting different engines. The curves are based on an engine start time of 90 seconds.

Section 5.6 shows pneumatic requirements for heating and cooling (air conditioning) using high pressure air to run the air cycle machine. The curves show airflow requirements to heat or cool the airplane within a given time and ambient conditions. Maximum allowable pressure and temperature for air cycle machine operation are 60 psia and 450⁰F, respectively.

Section 5.7 shows pneumatic requirements for heating and cooling the airplane, using low pressure conditioned air. This conditioned air is supplied through an 8-in ground air connection (GAC) directly to the passenger cabin, bypassing the air cycle machines.

Section 5.8 shows ground towing requirements for various ground surface conditions.

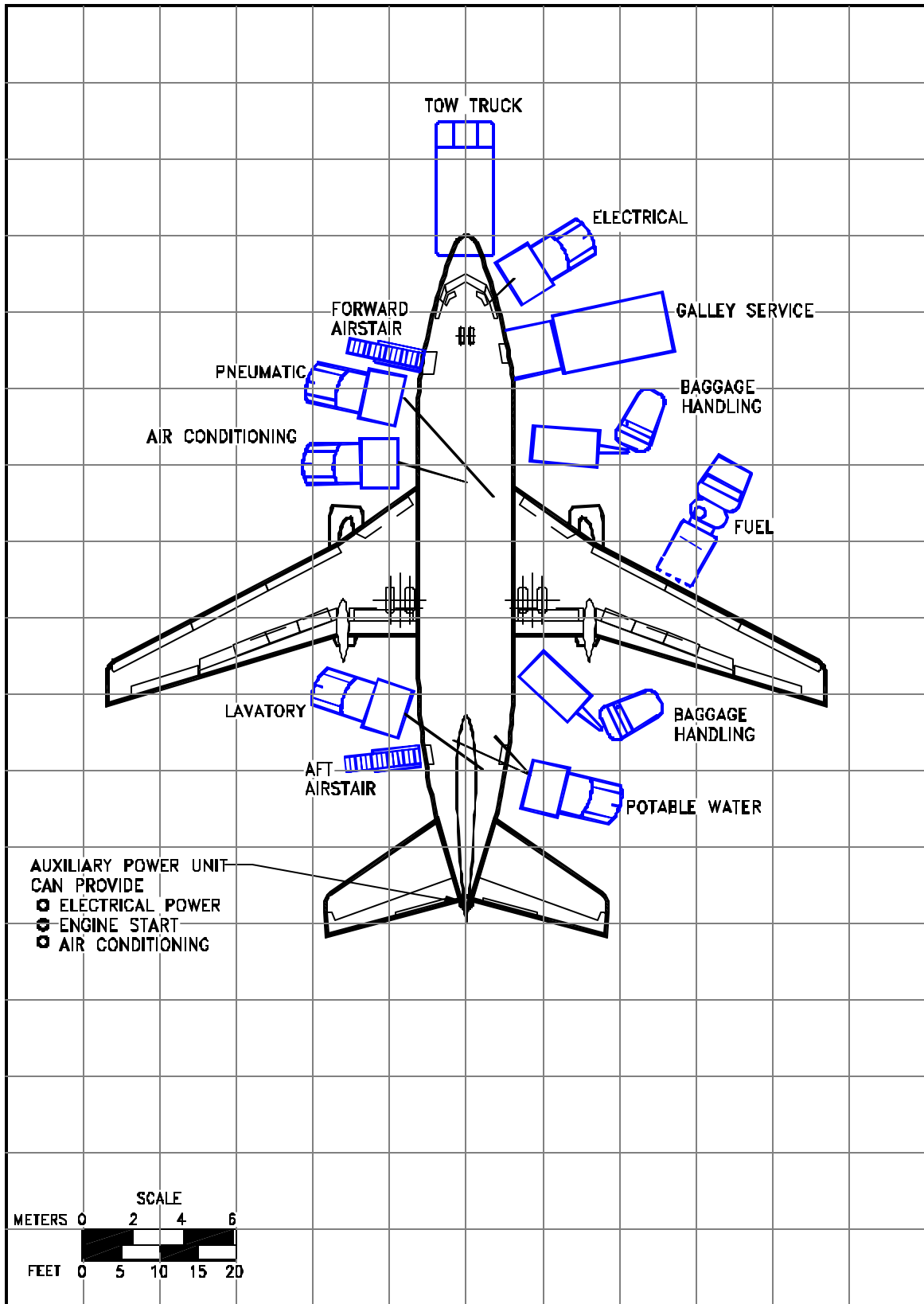

5.1.1 AIRPLANE SERVICING ARRANGEMENT - TYPICAL TURNAROUND
MODEL 737-100

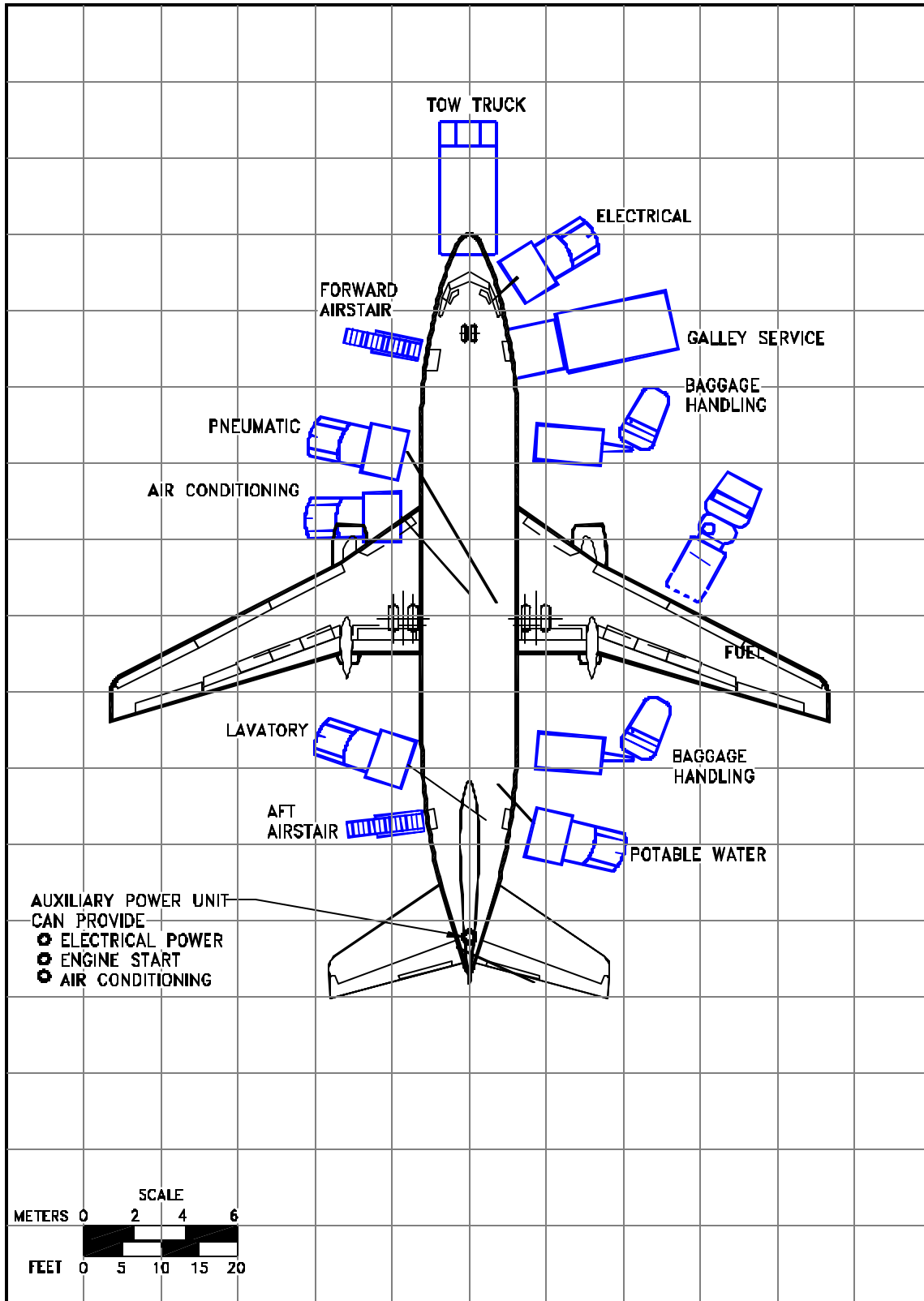

5.1.2 AIRPLANE SERVICING ARRANGEMENT - TYPICAL TURNAROUND
MODEL 737-200

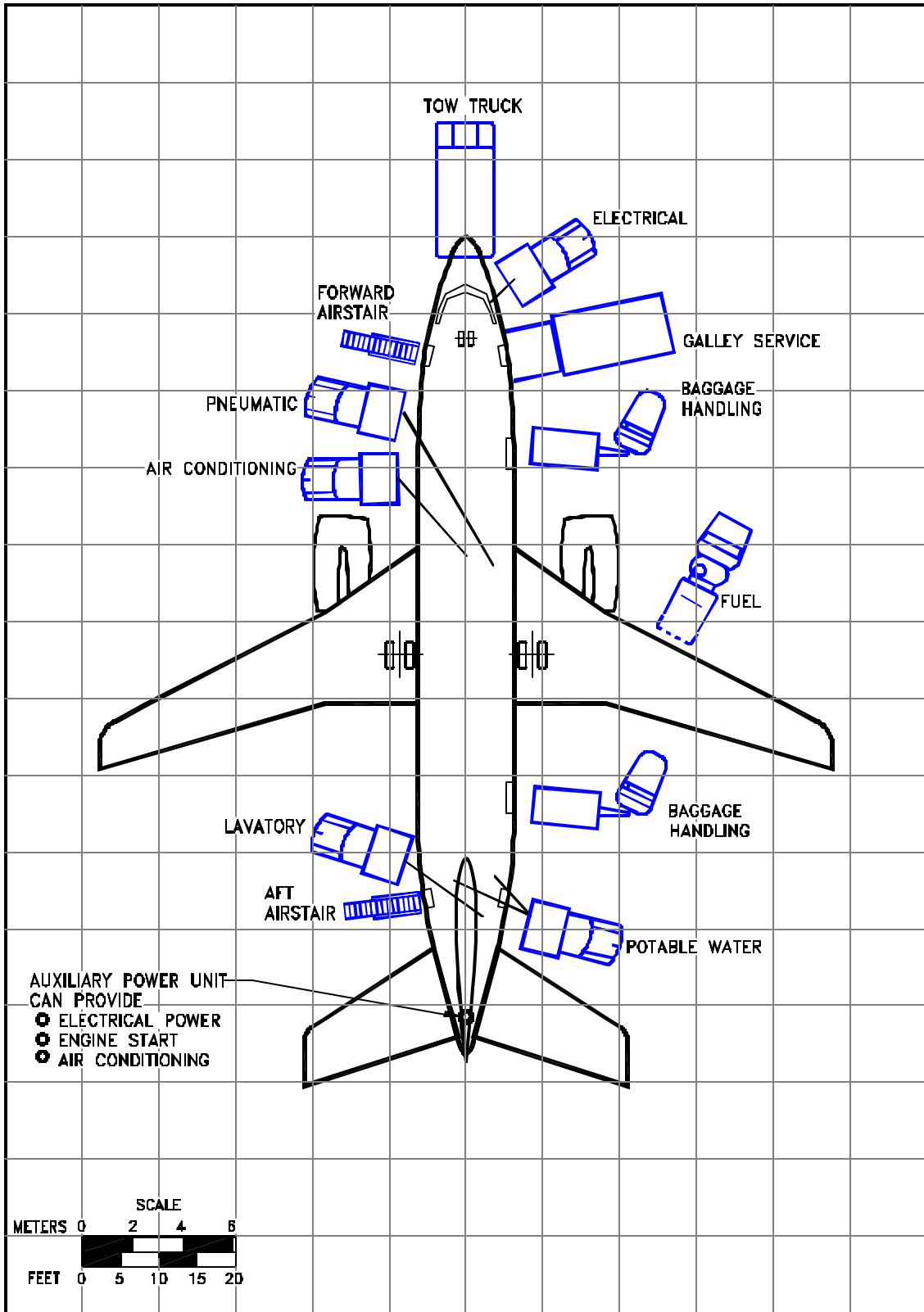

5.1.3 AIRPLANE SERVICING ARRANGEMENT - TYPICAL TURNAROUND
MODEL 737-300

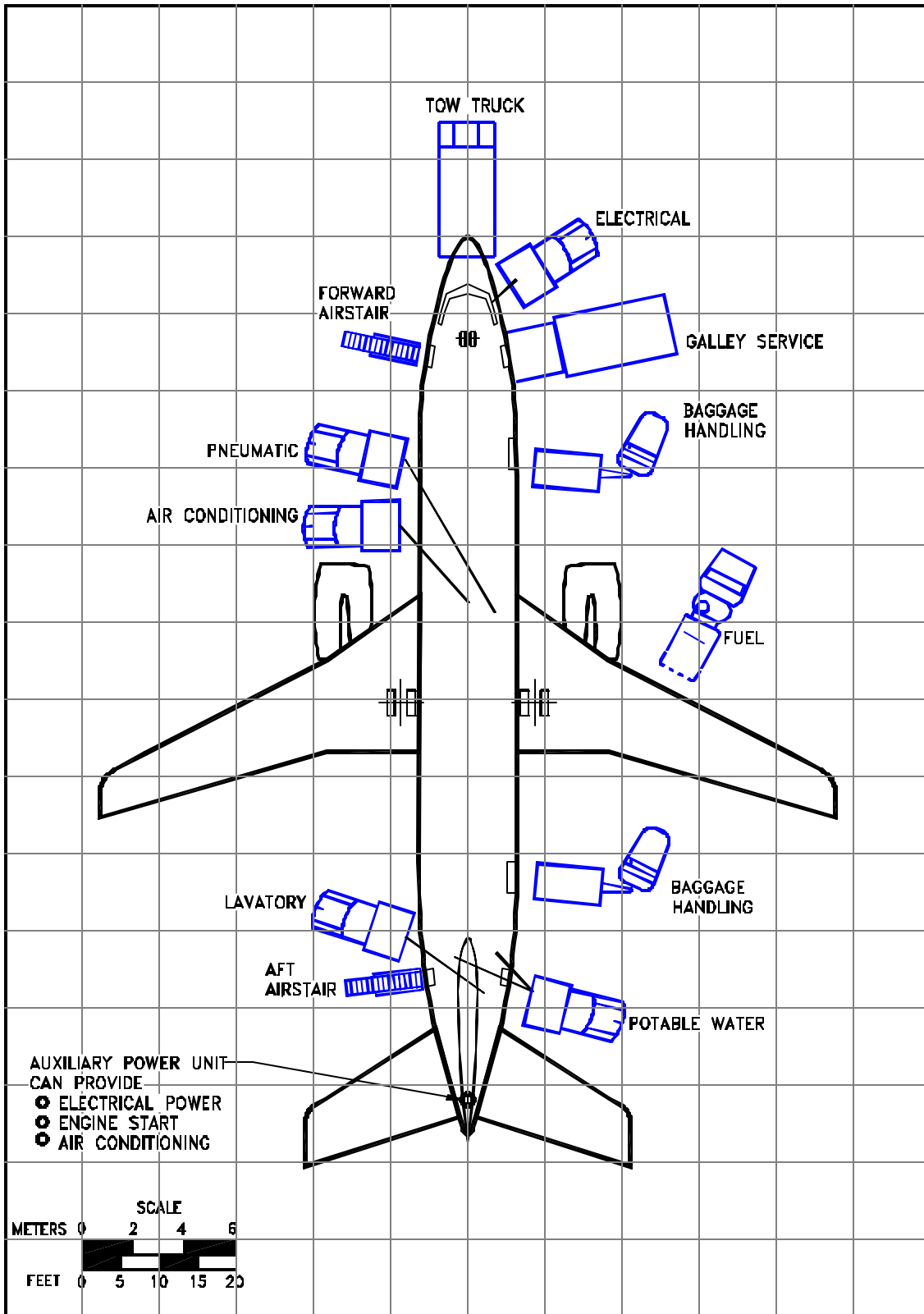

5.1.4 AIRPLANE SERVICING ARRANGEMENT - TYPICAL TURNAROUND

MODEL 737-600

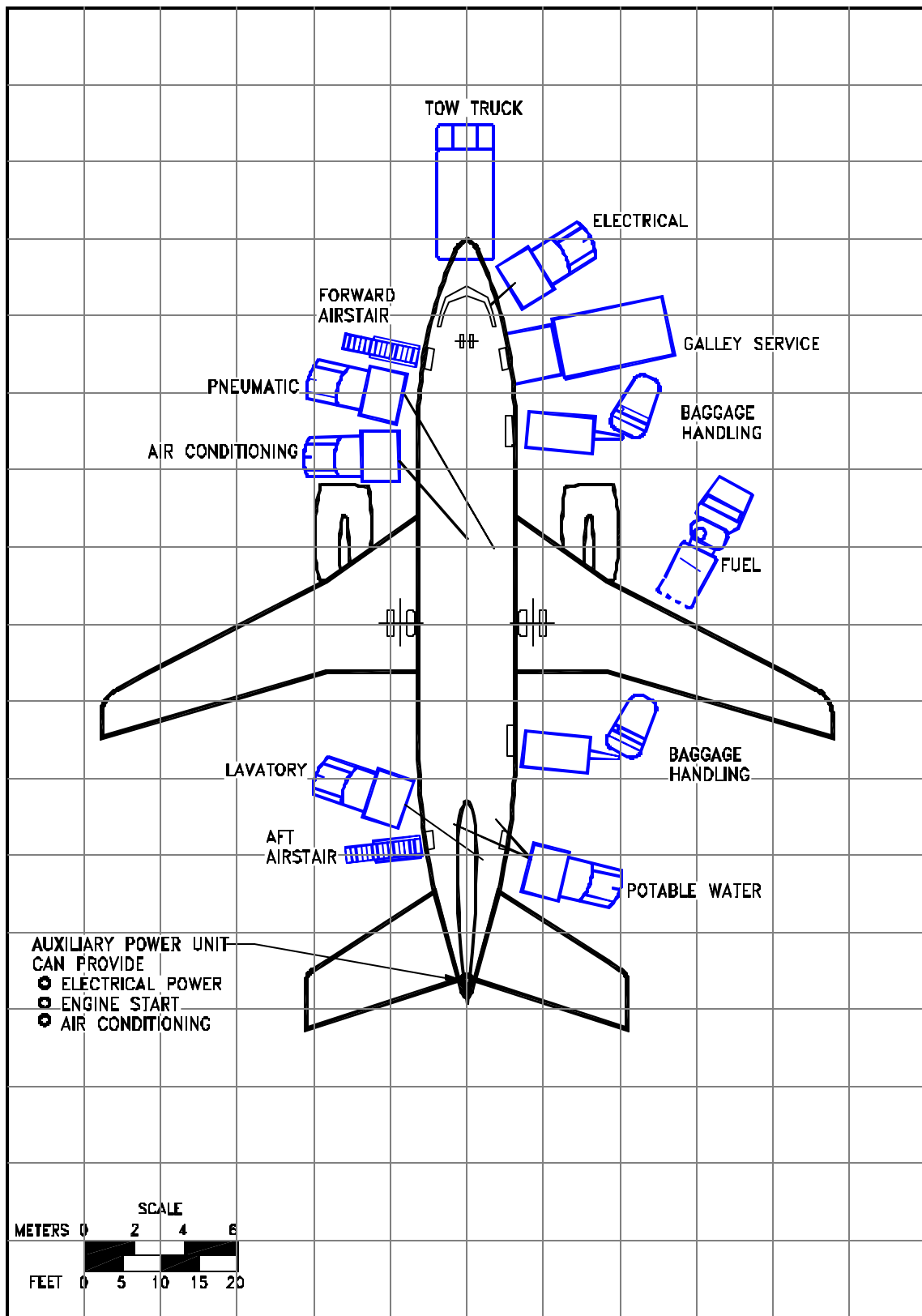

5.1.5 AIRPLANE SERVICING ARRANGEMENT - TYPICAL TURNAROUND
MODEL 737-500

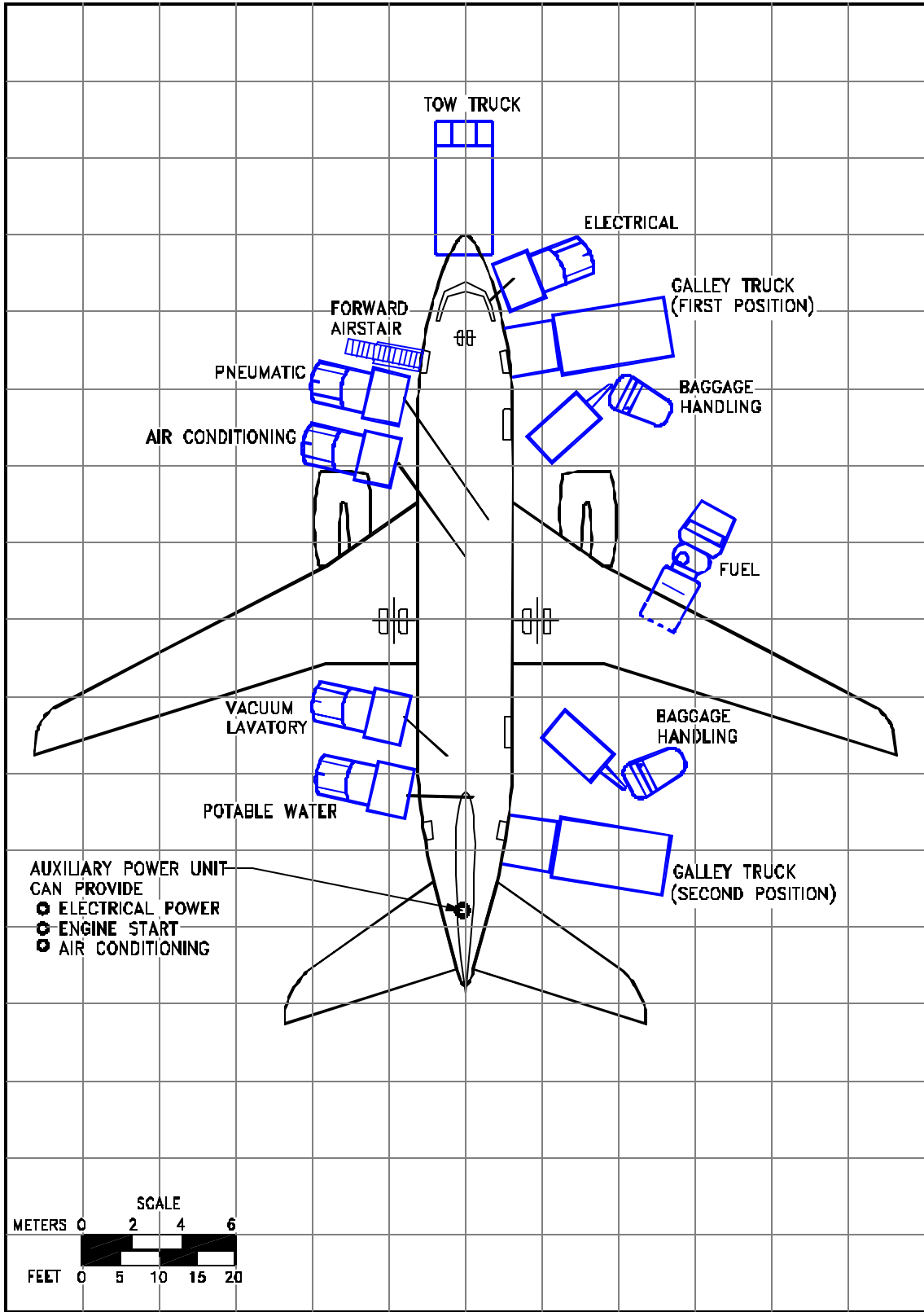

5.1.6 AIRPLANE SERVICING ARRANGEMENT - TYPICAL TURNAROUND
MODEL 737-600

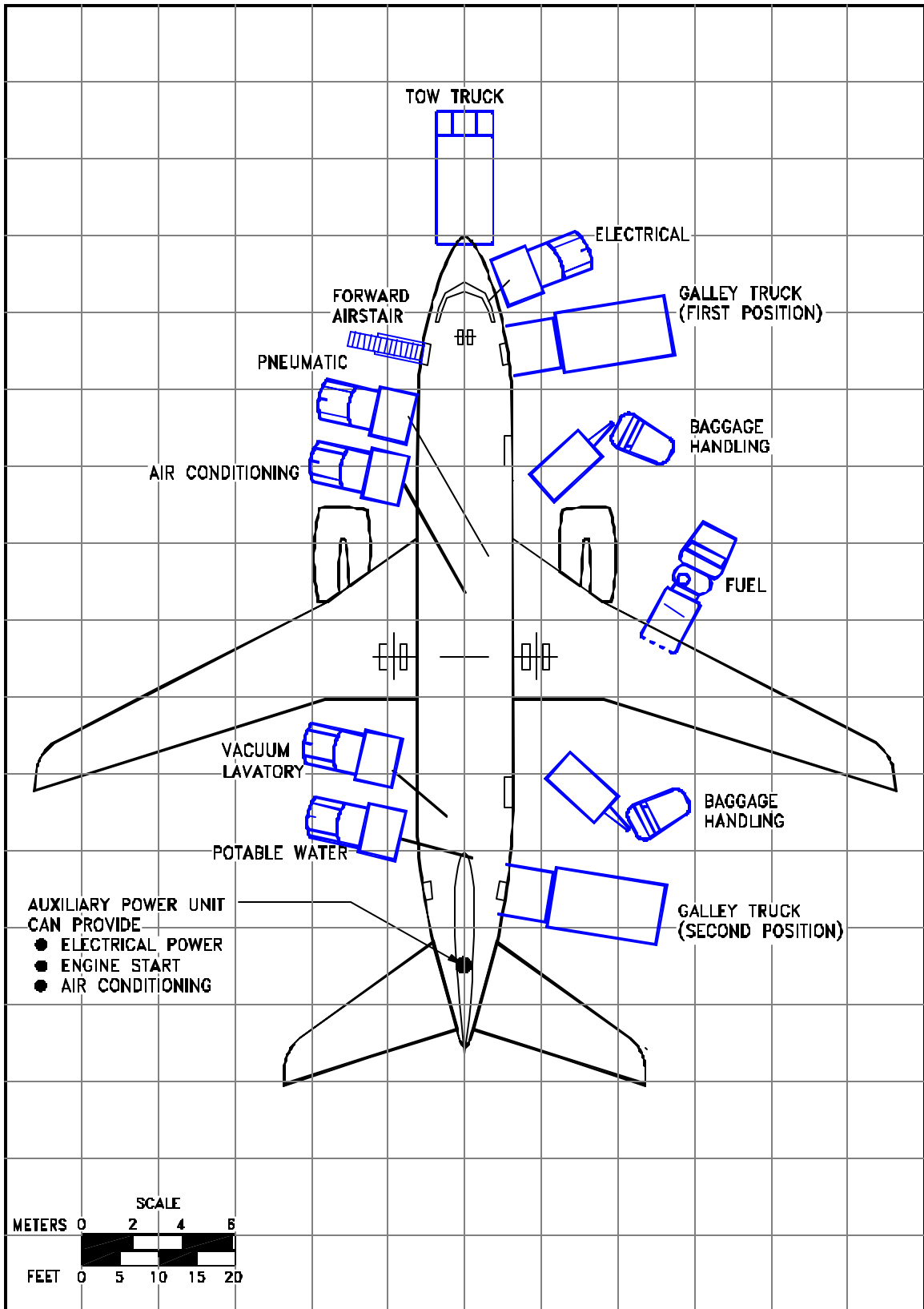

5.1.7 AIRPLANE SERVICING ARRANGEMENT - TYPICAL TURNAROUND
MODEL 737-700

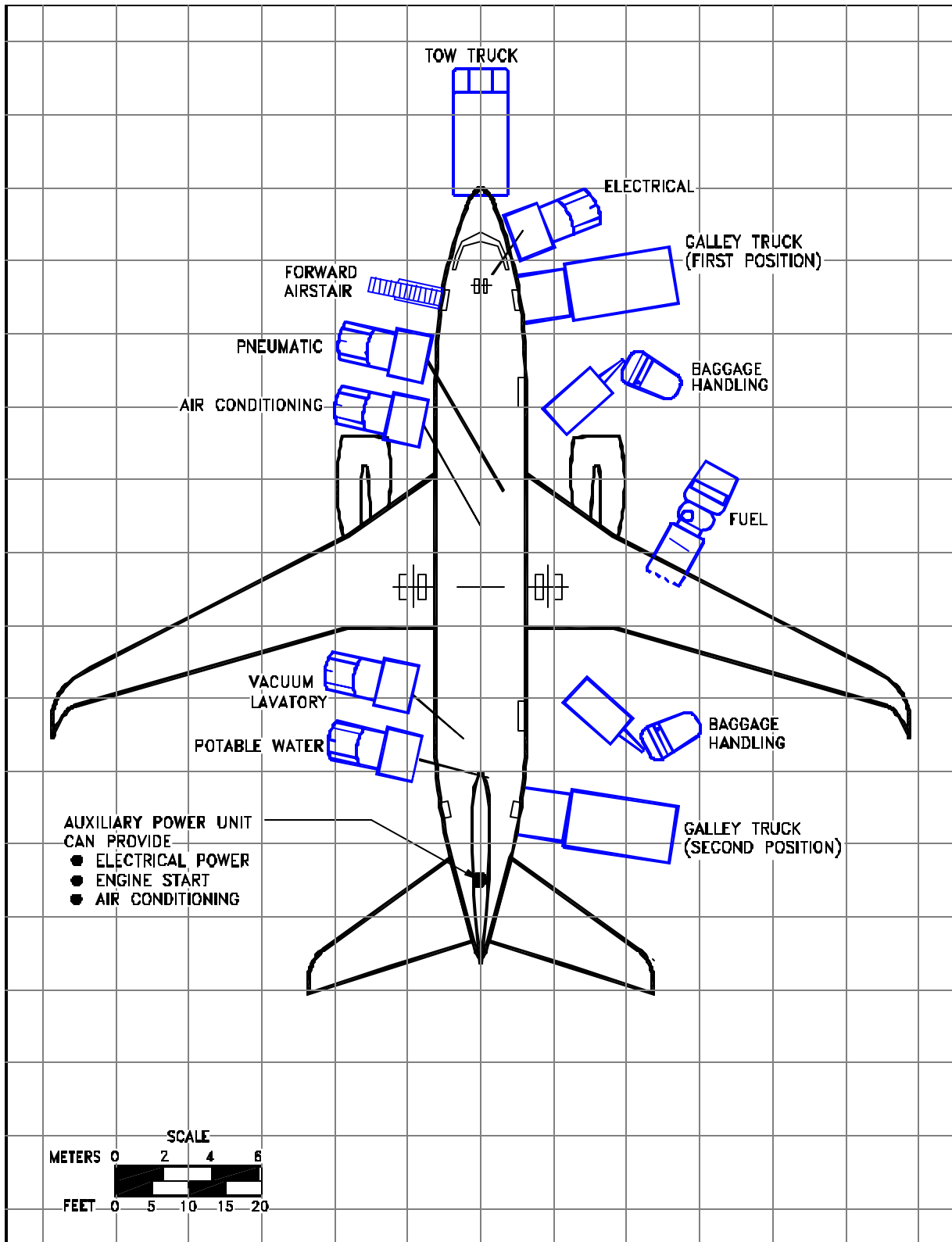

5.1.8 AIRPLANE SERVICING ARRANGEMENT - TYPICAL TURNAROUND
 MODEL 737-700 WITH WINGLETS, 737 BBJ

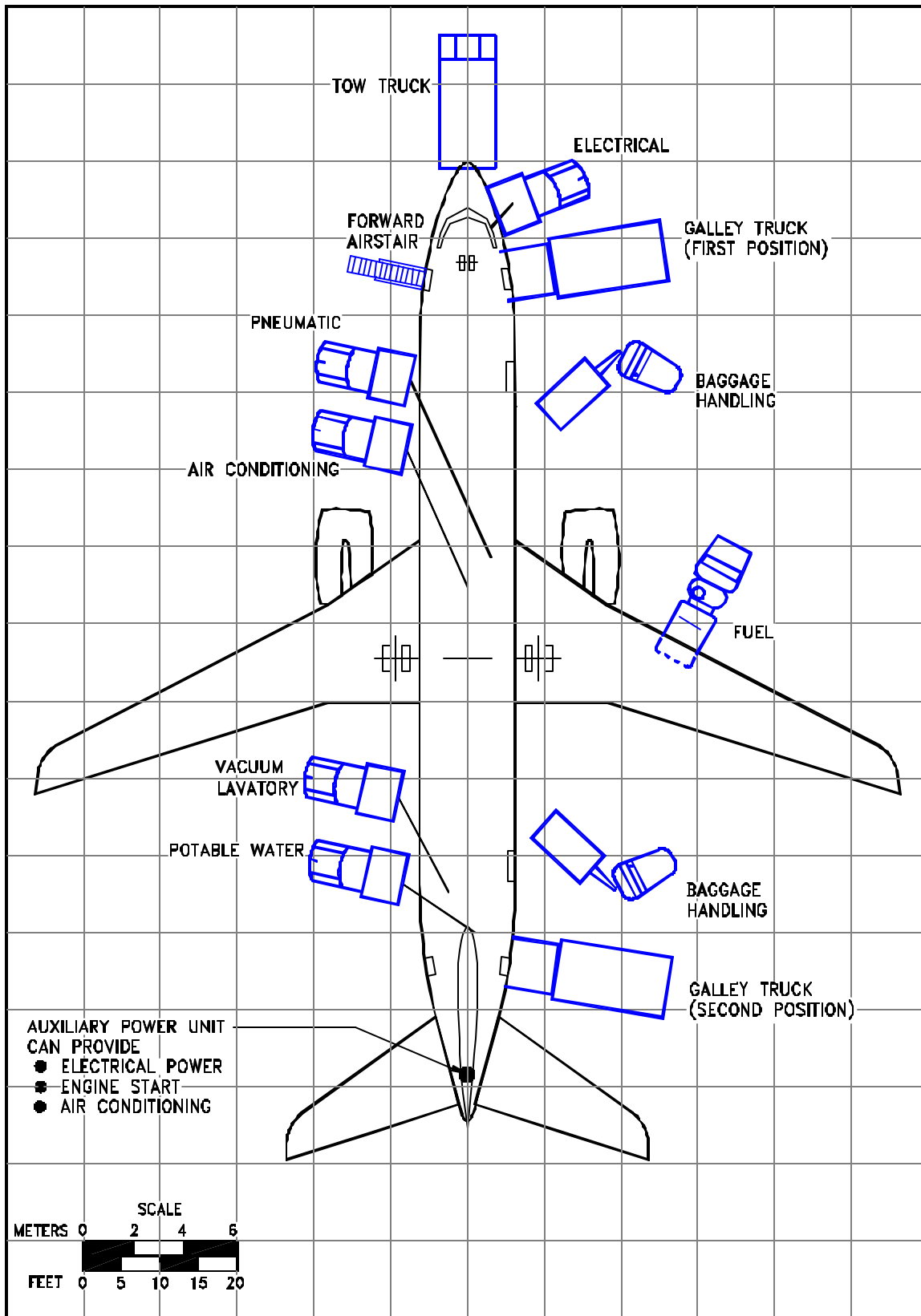

5.1.9. AIRPLANE SERVICING ARRANGEMENT - TYPICAL TURNAROUND
MODEL 737-800

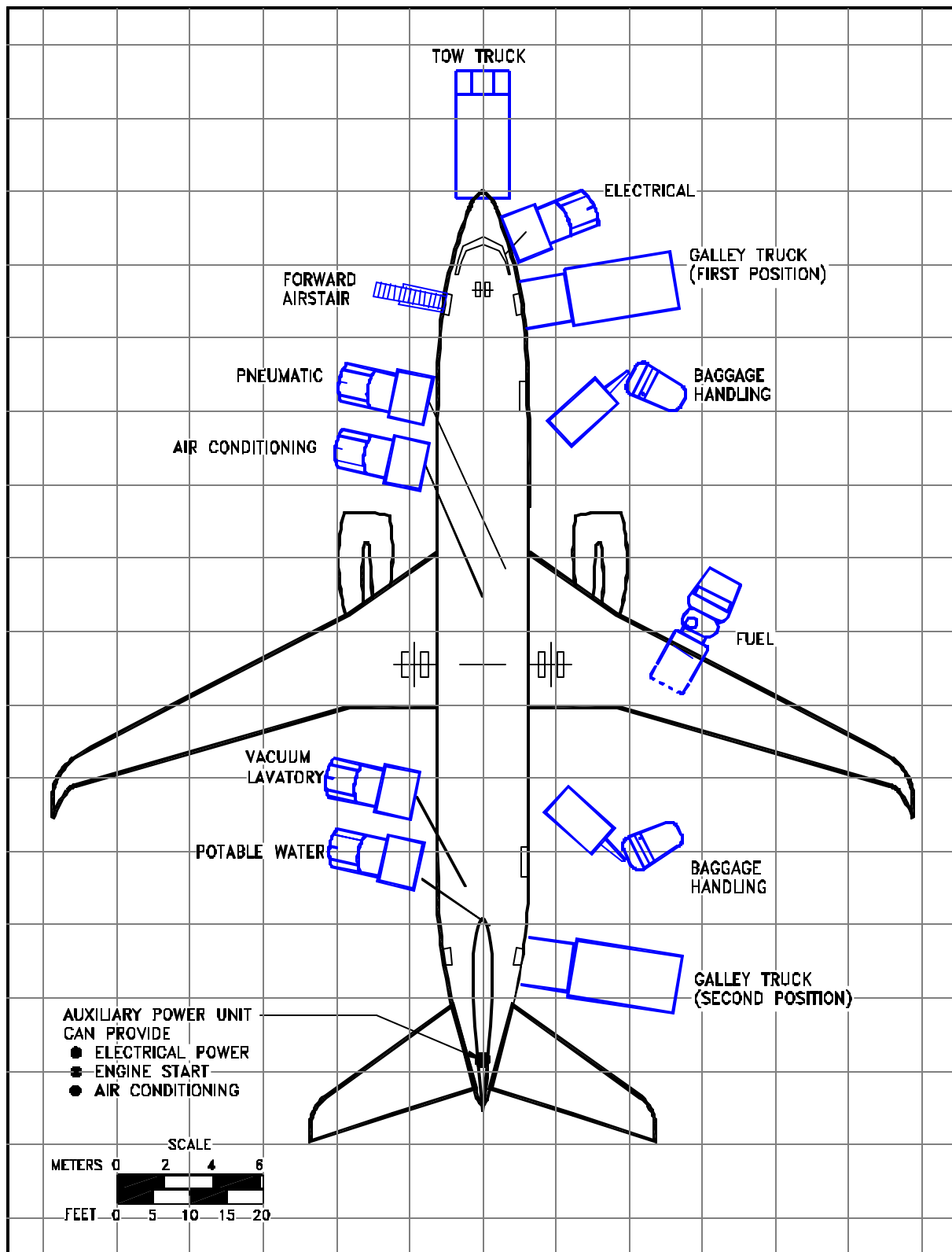

5.1.10 AIRPLANE SERVICING ARRANGEMENT - TYPICAL TURNAROUND
 MODEL 737-800 WITH WINGLETS, 737 BBJ2

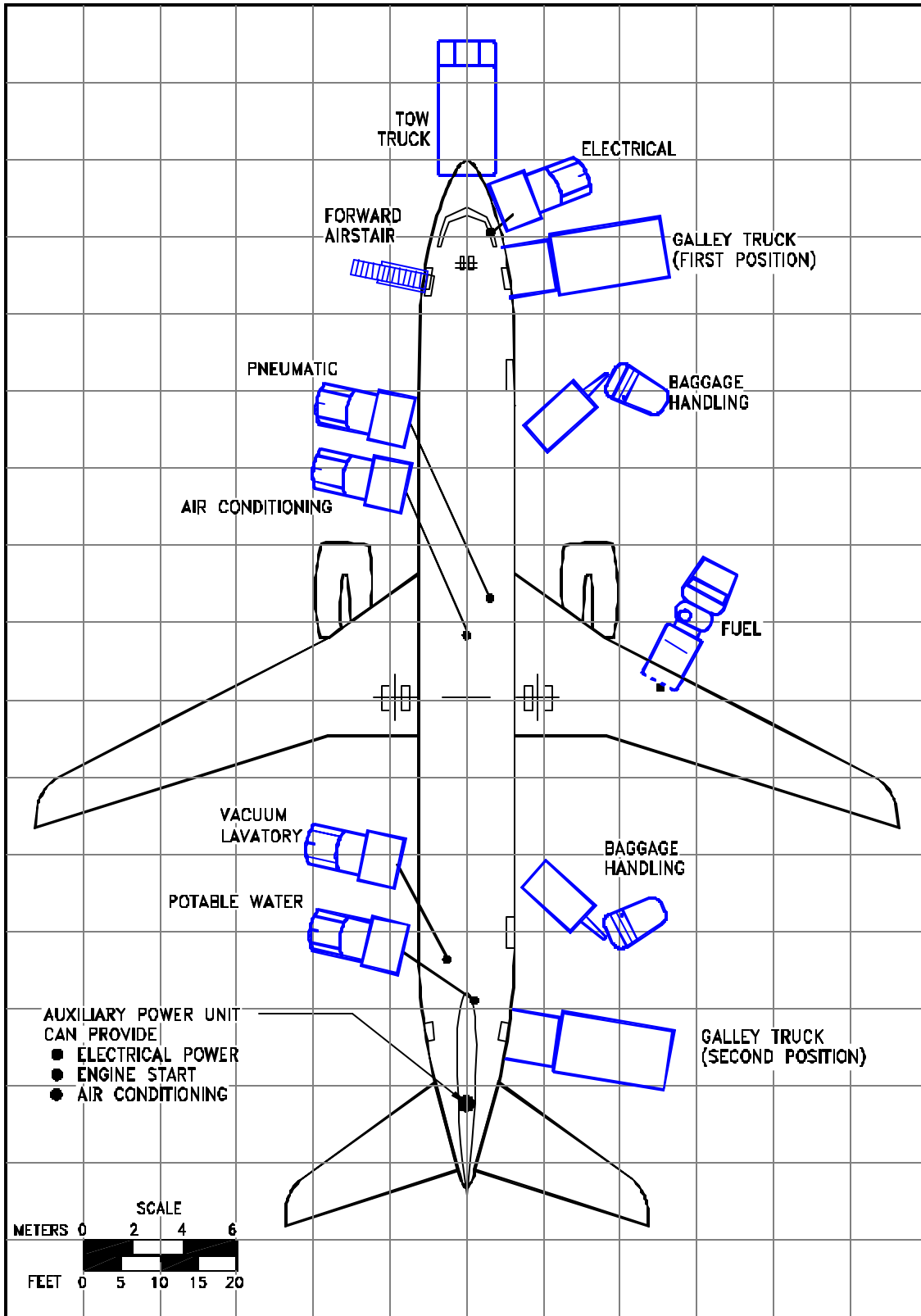

5.1.11. AIRPLANE SERVICING ARRANGEMENT - TYPICAL TURNAROUND
 MODEL 737-900, -900ER

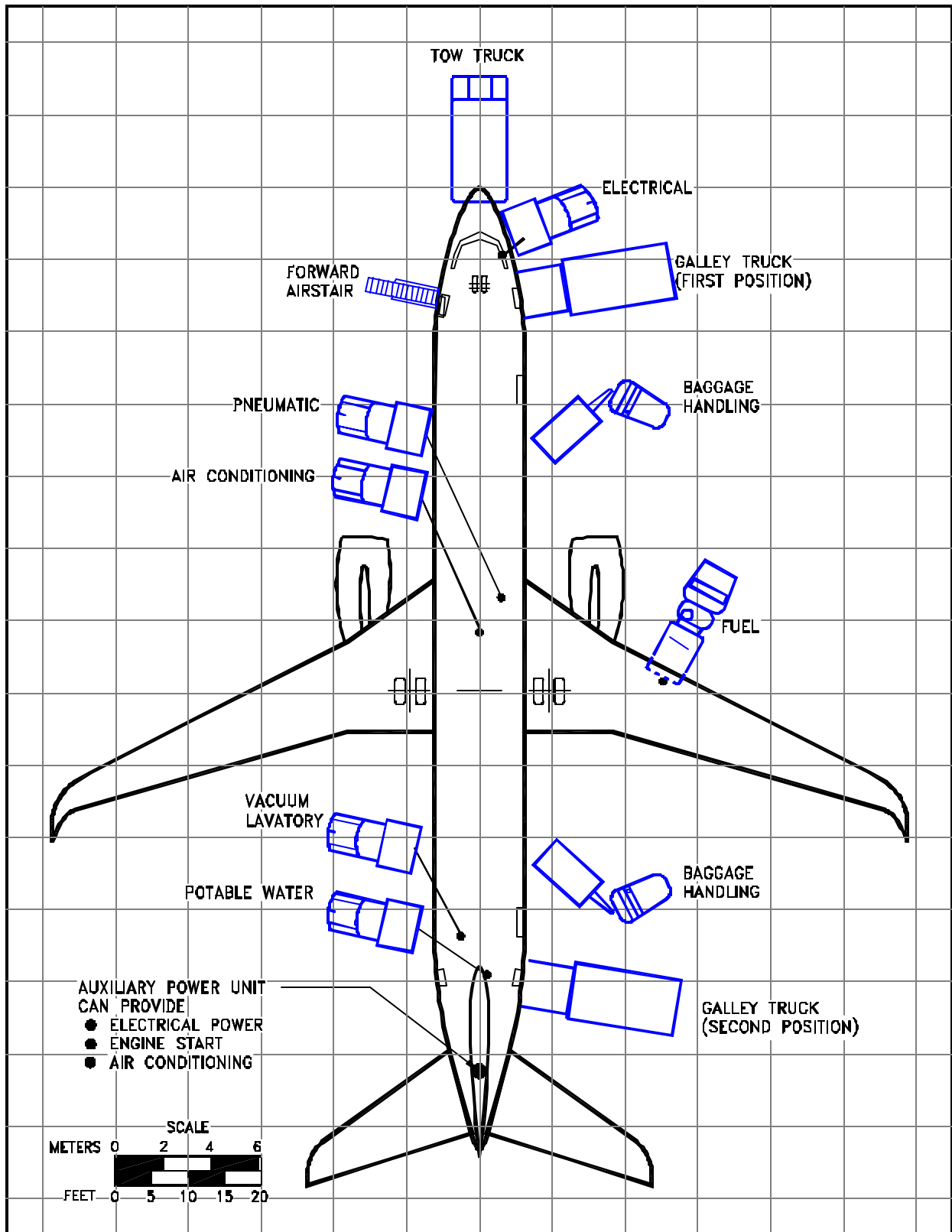

5.1.12 AIRPLANE SERVICING ARRANGEMENT - TYPICAL TURNAROUND
 MODEL 737-900, -900ER WITH WINGLETS

D6-58325-6

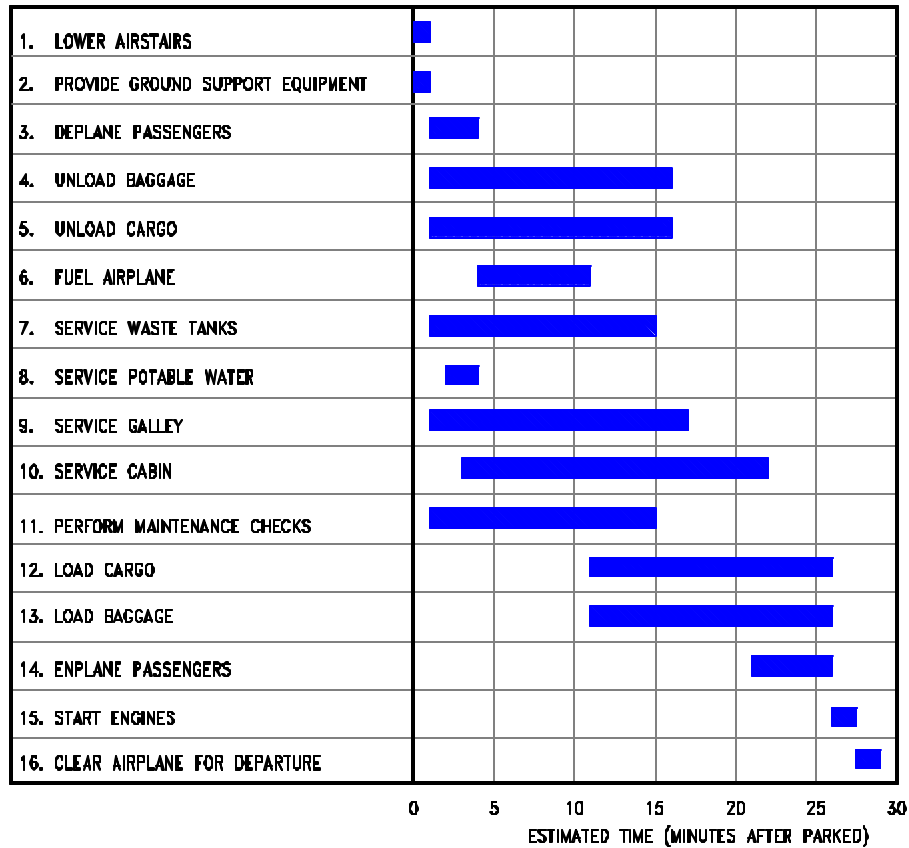

NOTES:

1. ESTIMATES BASED ON MIXED-CLASS CONFIGURATION, 65% LOAD FACTOR
2. IT IS ASSUMED THAT ALL EQUIPMENT FUNCTION PROPERLY AND THAT NO ABNORMAL WEATHER CONDITIONS EXIST.
3. TOTAL TIME ON THE RAMP IS 30 MINUTES
4. BOTH FORWARD AND AFT DOORS ARE USED
5. 100% PASSENGER EXCHANGE
6. THIS DATA IS PROVIDED TO ILLUSTRATE THE GENERAL SCOPE AND TYPES OF TASKS INVOLVED IN TERMINAL OPERATIONS. VARYING AIRLINE PRACTICES AND OPERATING CIRCUMSTANCES THROUGHOUT THE WORLD WILL RESULT IN DIFFERENT SEQUENCES AND TIME INTERVALS TO ACCOMPLISH THE TASKS SHOWN.
7. GROUND OPERATIONS REQUIREMENTS SHOULD BE COORDINATED WITH USING AIRLINES PRIOR TO RAMP PLANNING

5.2.1 TERMINAL OPERATIONS - TURNAROUND STATION

MODEL 737-100, -200

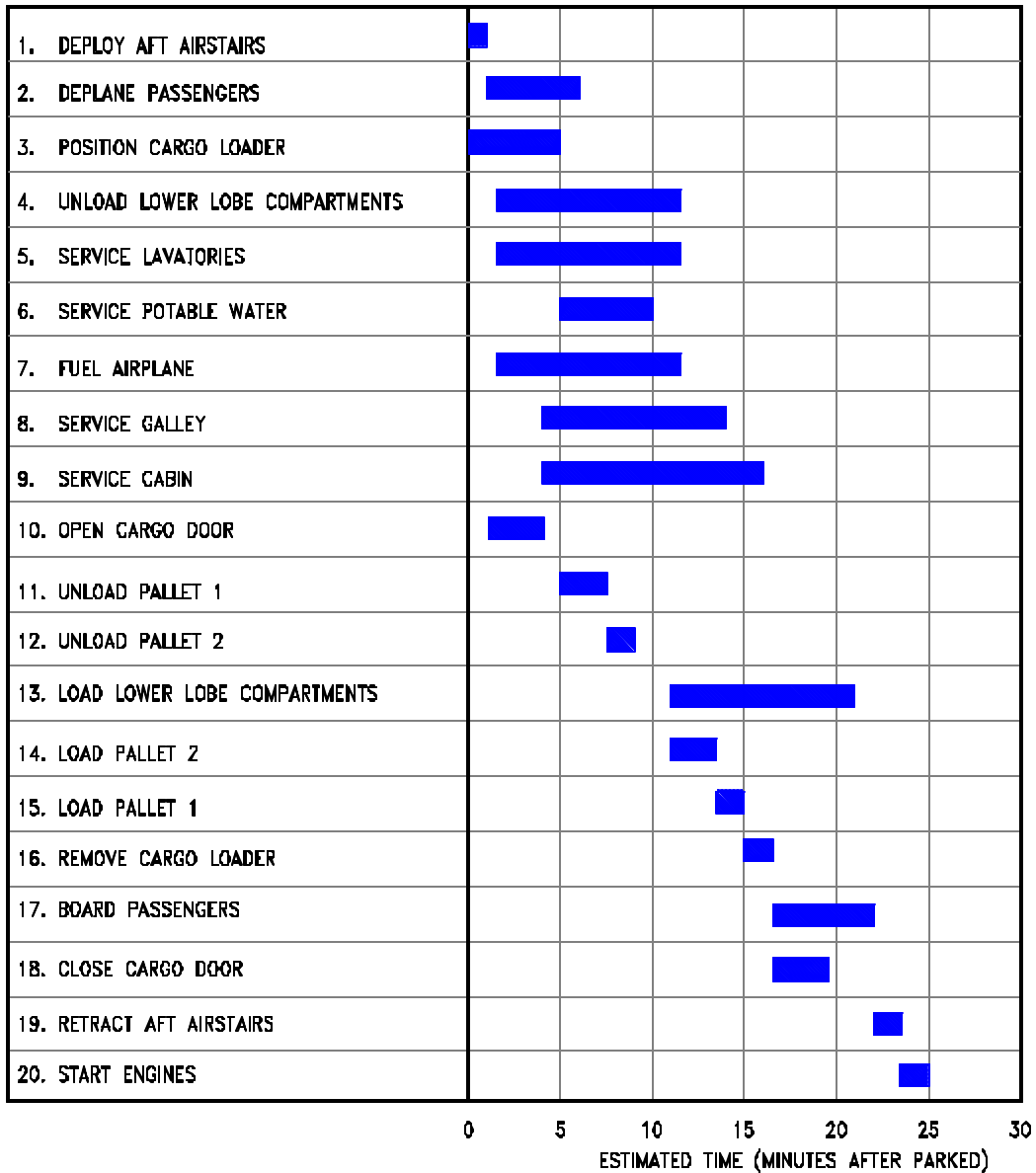

NOTES:

1. ESTIMATES BASED ON 76-PASSENGER/TWO MAIN DECK PALLET CONFIGURATION
100% LOAD FACTOR AND FULL PASSENGER/BAGGAGE EXCHANGE
2. IT IS ASSUMED THAT ALL EQUIPMENT FUNCTION PROPERLY AND THAT NO ABNORMAL WEATHER CONDITIONS EXIST.
3. TOTAL TIME ON THE RAMP IS 25 MINUTES
4. THIS DATA IS PROVIDED TO ILLUSTRATE THE GENERAL SCOPE AND TYPES OF TASKS INVOLVED IN TERMINAL OPERATIONS. VARYING AIRLINE PRACTICES AND OPERATING CIRCUMSTANCES THROUGHOUT THE WORLD WILL RESULT IN DIFFERENT SEQUENCES AND TIME INTERVALS TO ACCOMPLISH THE TASKS SHOWN.
5. GROUND OPERATIONS REQUIREMENTS SHOULD BE COORDINATED WITH USING AIRLINES PRIOR TO RAMP PLANNING

5.2.2 TERMINAL OPERATIONS - TURNAROUND STATION, PASSENGER/CARGO

MODEL 737-200C

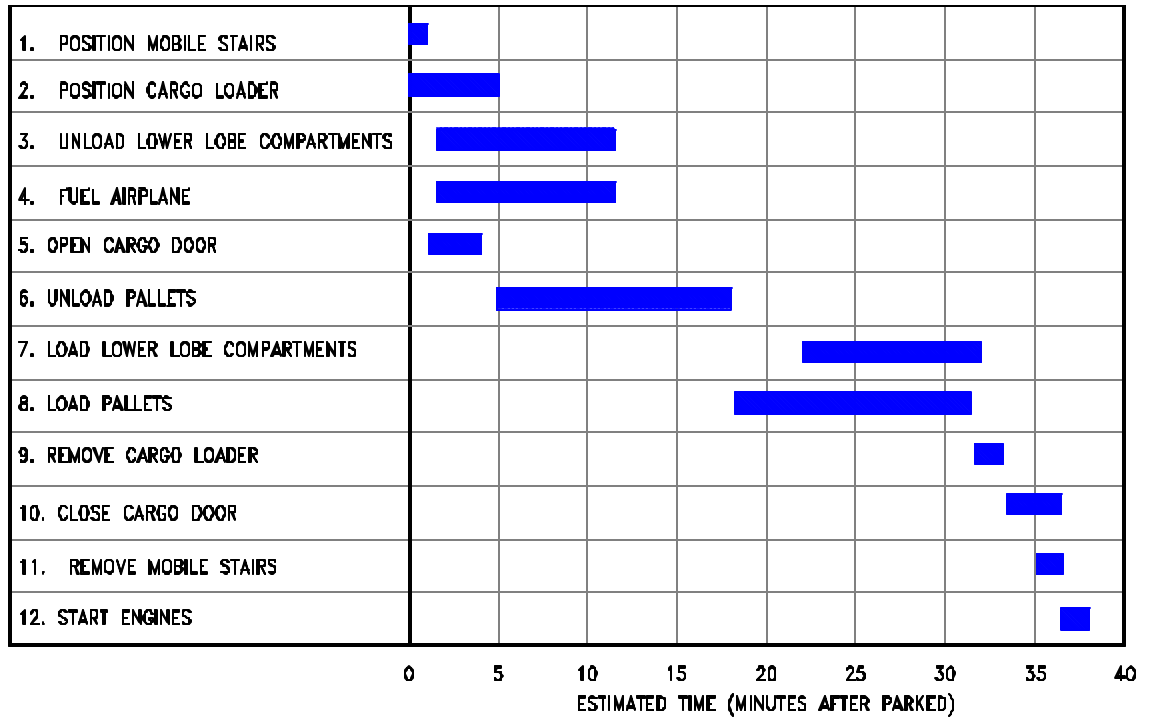

NOTES:

1. IT IS ASSUMED THAT ALL EQUIPMENT FUNCTION PROPERLY AND THAT NO ABNORMAL WEATHER CONDITIONS EXIST.
2. THIS DATA IS PROVIDED TO ILLUSTRATE THE GENERAL SCOPE AND TYPES OF TASKS INVOLVED IN TERMINAL OPERATIONS. VARYING AIRLINE PRACTICES AND OPERATING CIRCUMSTANCES THROUGHOUT THE WORLD WILL RESULT IN DIFFERENT SEQUENCES AND TIME INTERVALS TO ACCOMPLISH THE TASKS SHOWN.
3. GROUND OPERATIONS REQUIREMENTS SHOULD BE COORDINATED WITH USING AIRLINES PRIOR TO RAMP PLANNING

5.2.3 TERMINAL OPERATIONS - TURNAROUND STATION, ALL CARGO
MODEL 737-200C

5.2.5 TERMINAL OPERATIONS - TURNAROUND STATION MODEL 737-600

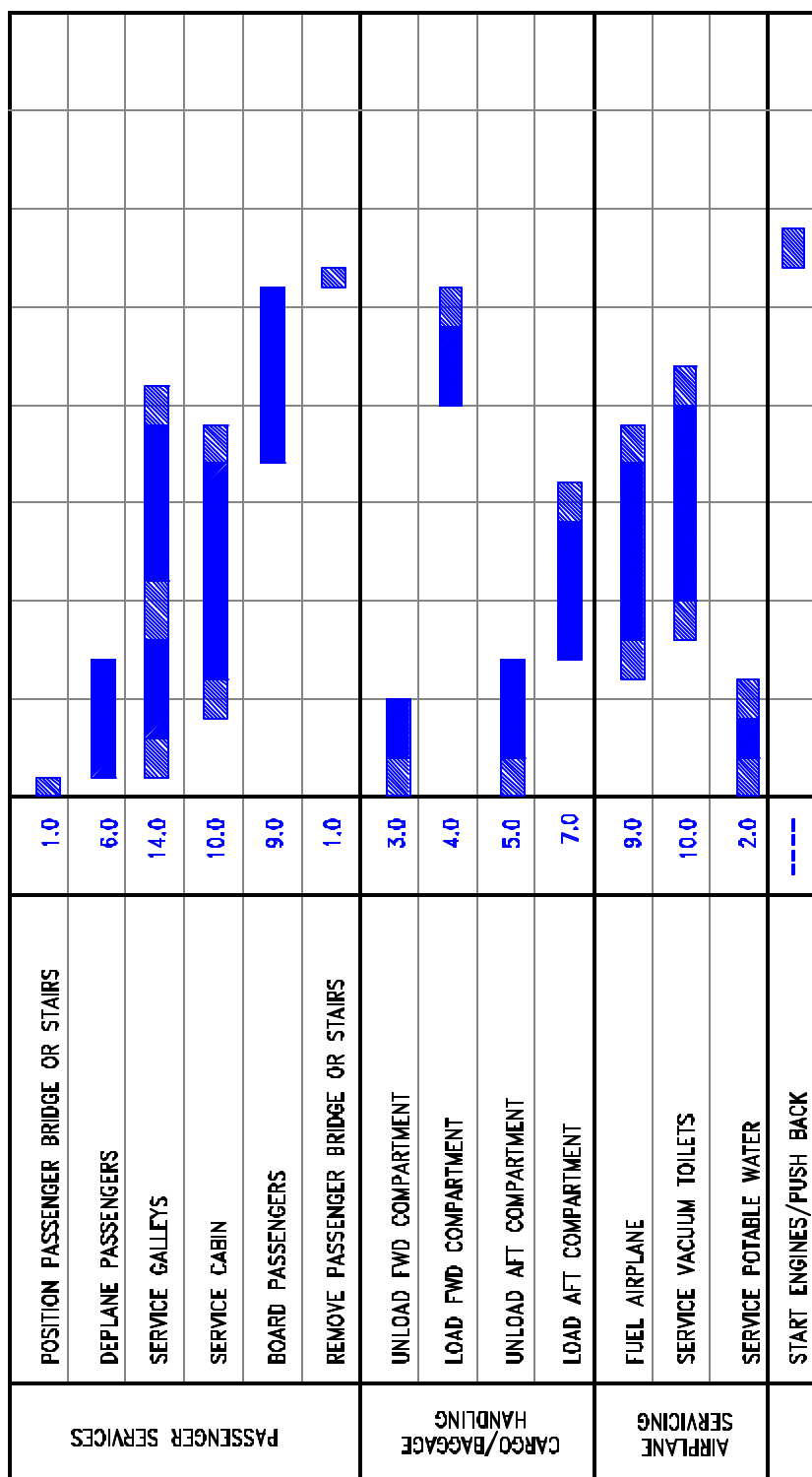

- NOTES:
- ▨ POSITION/REMOVE EQUIPMENT
 - 100% EXCHANGE OF PASSENGERS AND CARGO
 - 108 PASSENGERS BOARD AND DEPLANE VIA FWD LH ENTRY DOOR
 - FUEL - 2,700 GALLONS AT 300 GPM
1 NOZZLE AT 50 PSIG
1,000 GALLONS FUEL RESERVE
 - PASSENGER LOADING RATES:
UNLOADING - 18 PAX PER MINUTE
LOADING - 12 PAX PER MINUTE
 - BAGGAGE LOADING RATES:
UNLOADING - 15.0 BAGS PER MINUTE
LOADING - 10.0 BAGS PER MINUTE
 - 1.0 BAGS PER PAX (3.0 CU FT)
 - 38 BAGS FWD/70 BAGS AFT
 - 83% STACKING EFFICIENCY
 - 1 GALLEY TRUCK USED
 - 100% LOAD FACTOR

THIS DATA IS PROVIDED TO ILLUSTRATE THE GENERAL SCOPE AND TYPES OF TASKS INVOLVED IN TERMINAL OPERATIONS. VARYING AIRLINE PRACTICES AND OPERATING CIRCUMSTANCES THROUGHOUT THE WORLD WILL RESULT IN DIFFERENT SEQUENCES AND TIME INTERVALS TO ACCOMPLISH THE TASKS SHOWN.

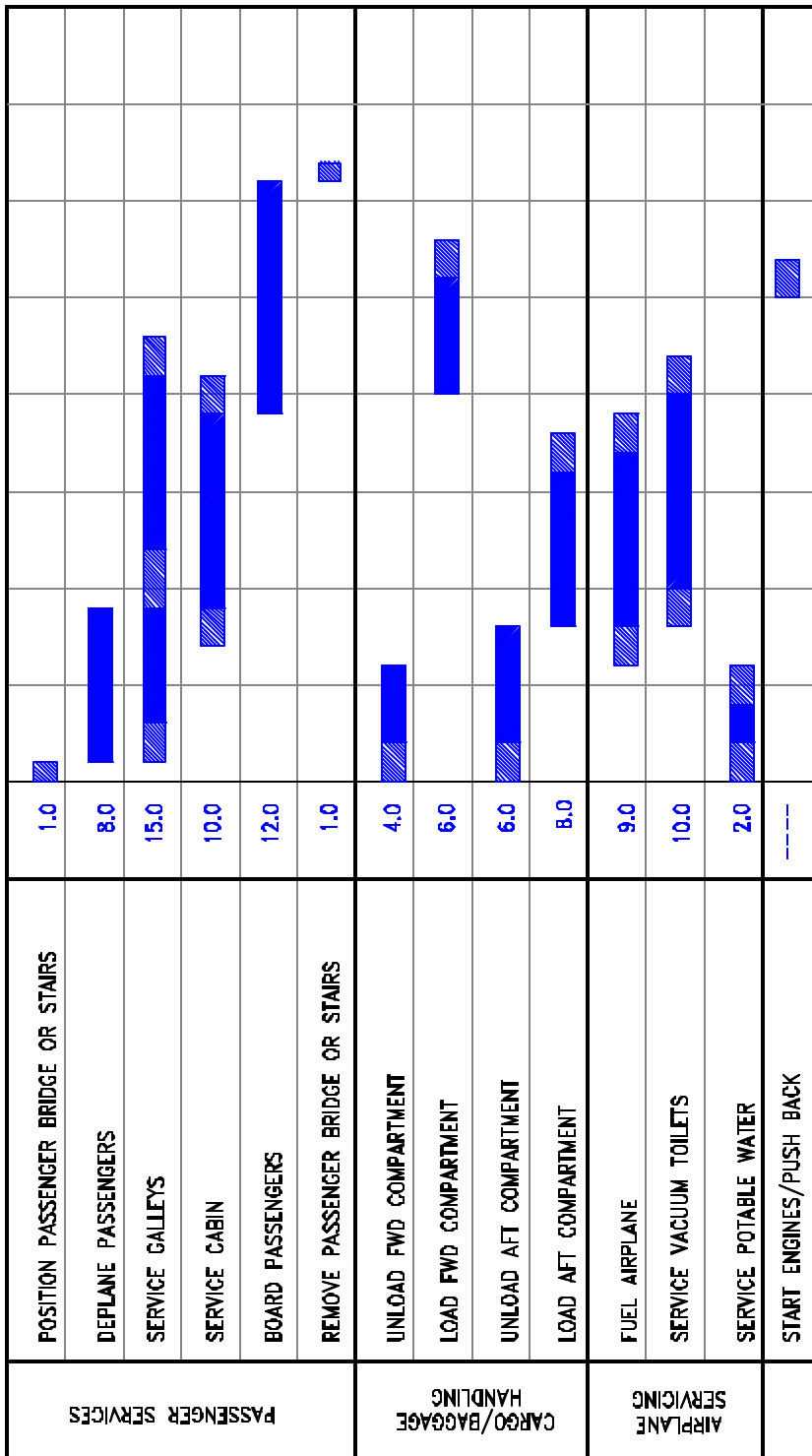

NOTES: POSITION/REMOVE EQUIPMENT

- 100% EXCHANGE OF PASSENGERS AND CARGO
- 140 PASSENGERS BOARD AND DEPLANE VIA FWD LH ENTRY DOOR
- FUEL - 2,700 GALLONS AT 300 GPM
- 1 NOZZLE AT 50 PSIG
- 1,000 GALLONS FUEL RESERVE
- PASSENGER LOADING RATES:
UNLOADING - 18 PAX PER MINUTE
LOADING - 12 PAX PER MINUTE
- BAGGAGE LOADING RATES:
UNLOADING - 15.0 BAGS PER MINUTE
LOADING - 10.0 BAGS PER MINUTE
- 1.0 BAGS PER PAX (3.0 CU FT)
- 57 BAGS FWD/83 BAGS AFT
- 83% STACKING EFFICIENCY
- 1 GALLEY TRUCK USED
- 100% LOAD FACTOR

THIS DATA IS PROVIDED TO ILLUSTRATE THE GENERAL SCOPE AND TYPES OF TASKS INVOLVED IN TERMINAL OPERATIONS. VARYING AIRLINE PRACTICES AND OPERATING CIRCUMSTANCES THROUGHOUT THE WORLD WILL RESULT IN DIFFERENT SEQUENCES AND TIME INTERVALS TO ACCOMPLISH THE TASKS SHOWN.

5.2.6 TERMINAL OPERATIONS - TURNAROUND STATION
MODEL 737-700, -700 WITH WINGLETS

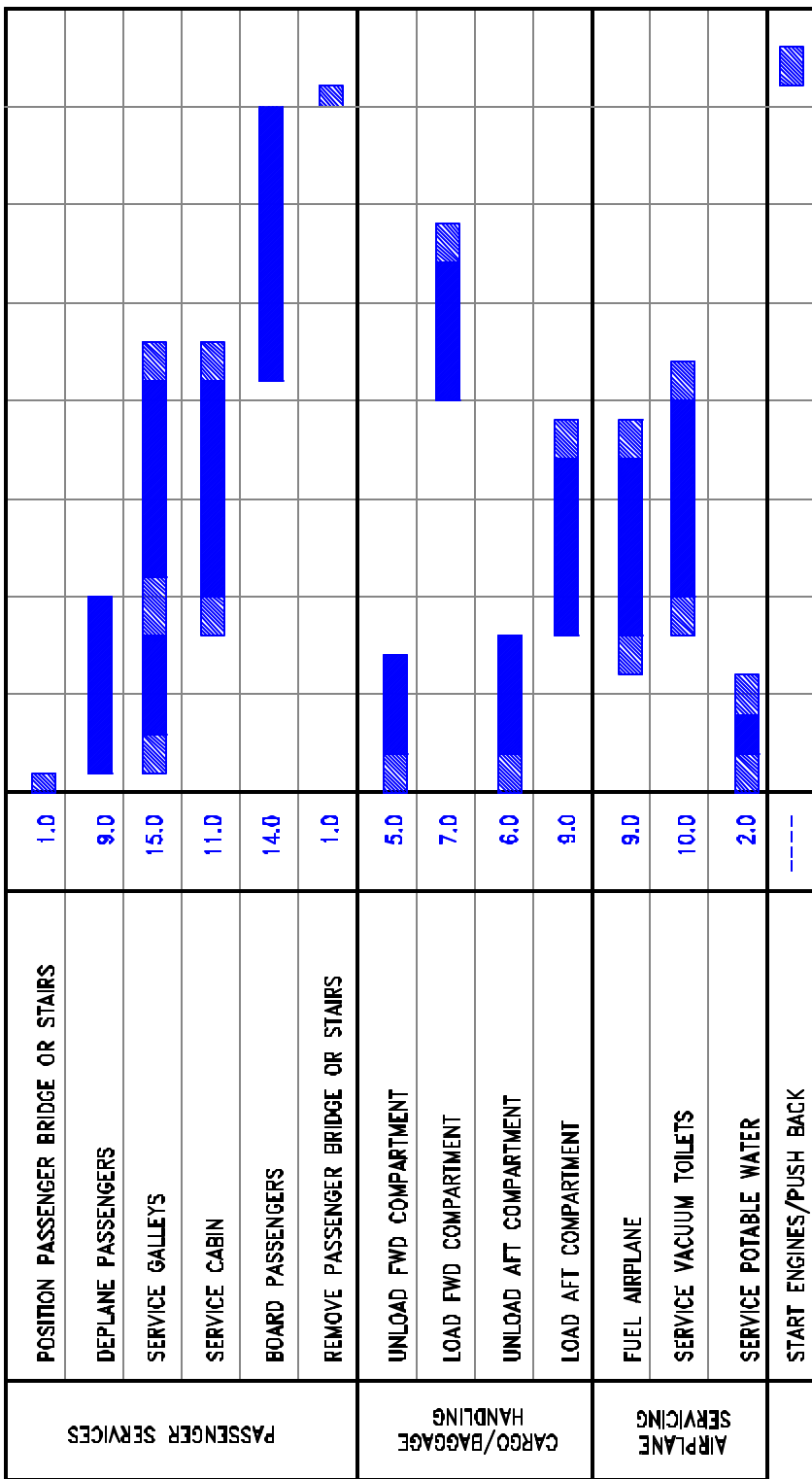

NOTES:

- ▨ POSITION/REMOVE EQUIPMENT
- 100% EXCHANGE OF PASSENGERS AND CARGO
- 160 PASSENGERS BOARD AND DEPLANE VIA FWD LH ENTRY DOOR
- FUEL - 2,700 GALLONS AT 300 GPM
- 1 NOZZLE AT 50 PSIG
- 1,000 GALLONS FUEL RESERVE
- PASSENGER LOADING RATES:
 - UNLOADING - 18 PAX PER MINUTE
 - LOADING - 12 PAX PER MINUTE
- BAGGAGE LOADING RATES:
 - UNLOADING - 15.0 BAGS PER MINUTE
 - LOADING - 10.0 BAGS PER MINUTE
- 1.0 BAGS PER PAX (3.0 CU FT)
- 69 BAGS FWD/91 BAGS AFT
- 83% STACKING EFFICIENCY
- 1 GALLEY TRUCK USED
- 100% LOAD FACTOR

THIS DATA IS PROVIDED TO ILLUSTRATE THE GENERAL SCOPE AND TYPES OF TASKS INVOLVED IN TERMINAL OPERATIONS. VARYING AIRLINE PRACTICES AND OPERATING CIRCUMSTANCES THROUGHOUT THE WORLD WILL RESULT IN DIFFERENT SEQUENCES AND TIME INTERVALS TO ACCOMPLISH THE TASKS SHOWN.

5.2.7 TERMINAL OPERATIONS - TURNAROUND STATION
 MODEL 737-800, -800 WITH WINGLETS

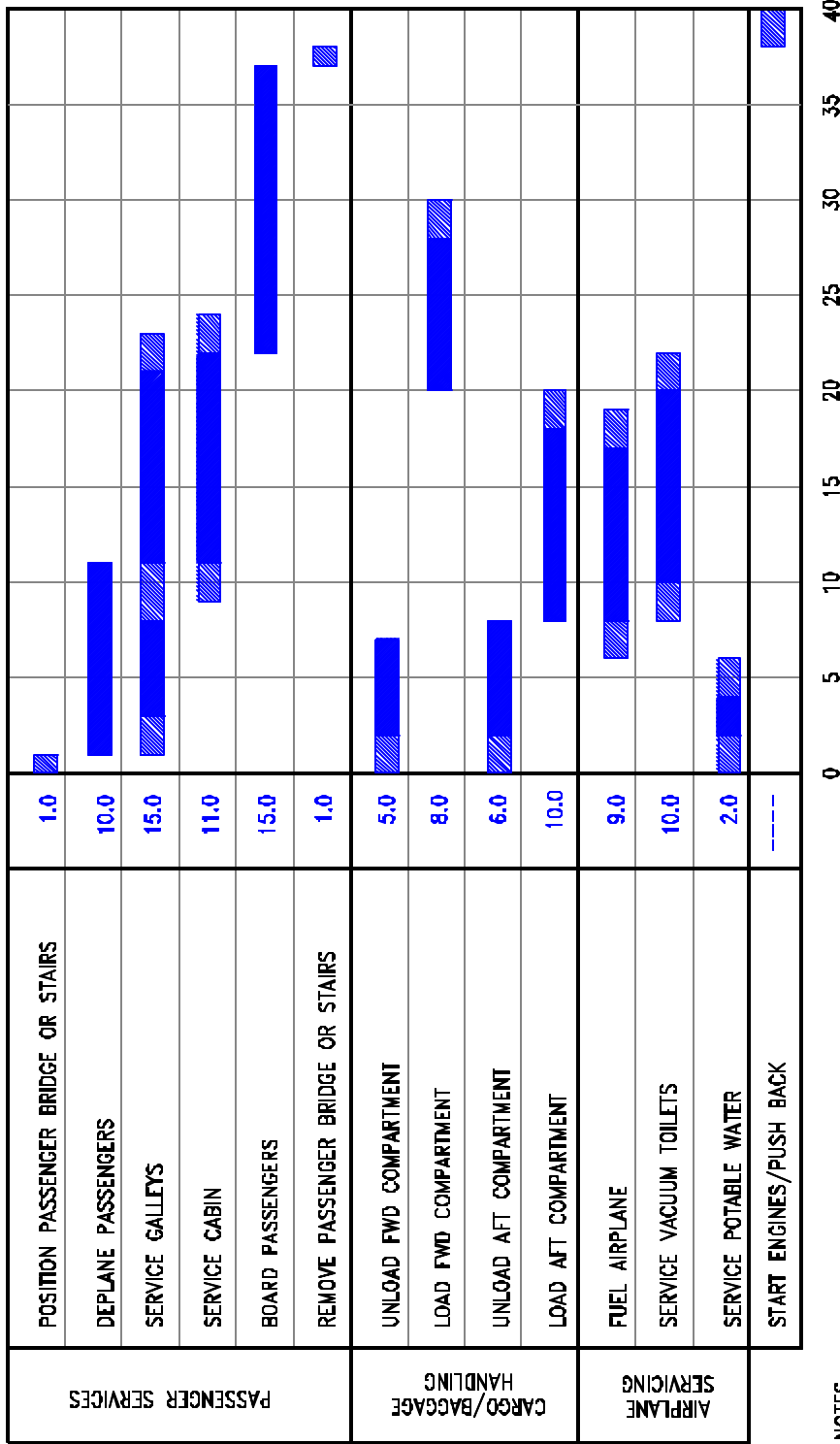

NOTES:

▨ POSITION/REMOVE EQUIPMENT

● 100% EXCHANGE OF PASSENGERS AND CARGO

● 177 PASSENGERS BOARD AND DEPLANE VIA FWD LH ENTRY DOOR

● FUEL - 2,700 GALLONS AT 300 GPM

1 NOZZLE AT 50 PSIG

1,000 GALLONS FUEL RESERVE

● PASSENGER LOADING RATES:

UNLOADING - 1B PAX PER MINUTE

LOADING - 12 PAX PER MINUTE

● BAGGAGE LOADING RATES:

UNLOADING - 15.0 BAGS PER MINUTE

LOADING - 10.0 BAGS PER MINUTE

● 1.0 BAGS PER PAX (3.0 CU FT)

● 80 BAGS FWD/97 BAGS AFT

83% STACKING EFFICIENCY

● 1 GALLEY TRUCK USED

● 100% LOAD FACTOR

THIS DATA IS PROVIDED TO ILLUSTRATE THE GENERAL SCOPE AND TYPES OF TASKS INVOLVED IN TERMINAL OPERATIONS. VARYING AIRLINE PRACTICES AND OPERATING CIRCUMSTANCES THROUGHOUT THE WORLD WILL RESULT IN DIFFERENT SEQUENCES AND TIME INTERVALS TO ACCOMPLISH THE TASKS SHOWN.

5.2.8 TERMINAL OPERATIONS - TURNAROUND STATION
MODEL 737-900, -900ER, WITH AND WITHOUT WINGLETS

NOTE

**TURNAROUND TERMINAL OPERATIONS TIME CHARTS
ARE NOT INCLUDED IN THIS DOCUMENT
BECAUSE THE DIFFERENT CONFIGURATIONS
OF BOEING BUSINESS JET AIRPLANES
HAVE INDIVIDUAL REQUIREMENTS.
CONSULT AIRCRAFT USER/OPERATOR FOR CURRENT
REQUIREMENTS**

5.2.9 TERMINAL OPERATIONS - TURNAROUND STATION
MODEL 737 BBJ, BBJ2

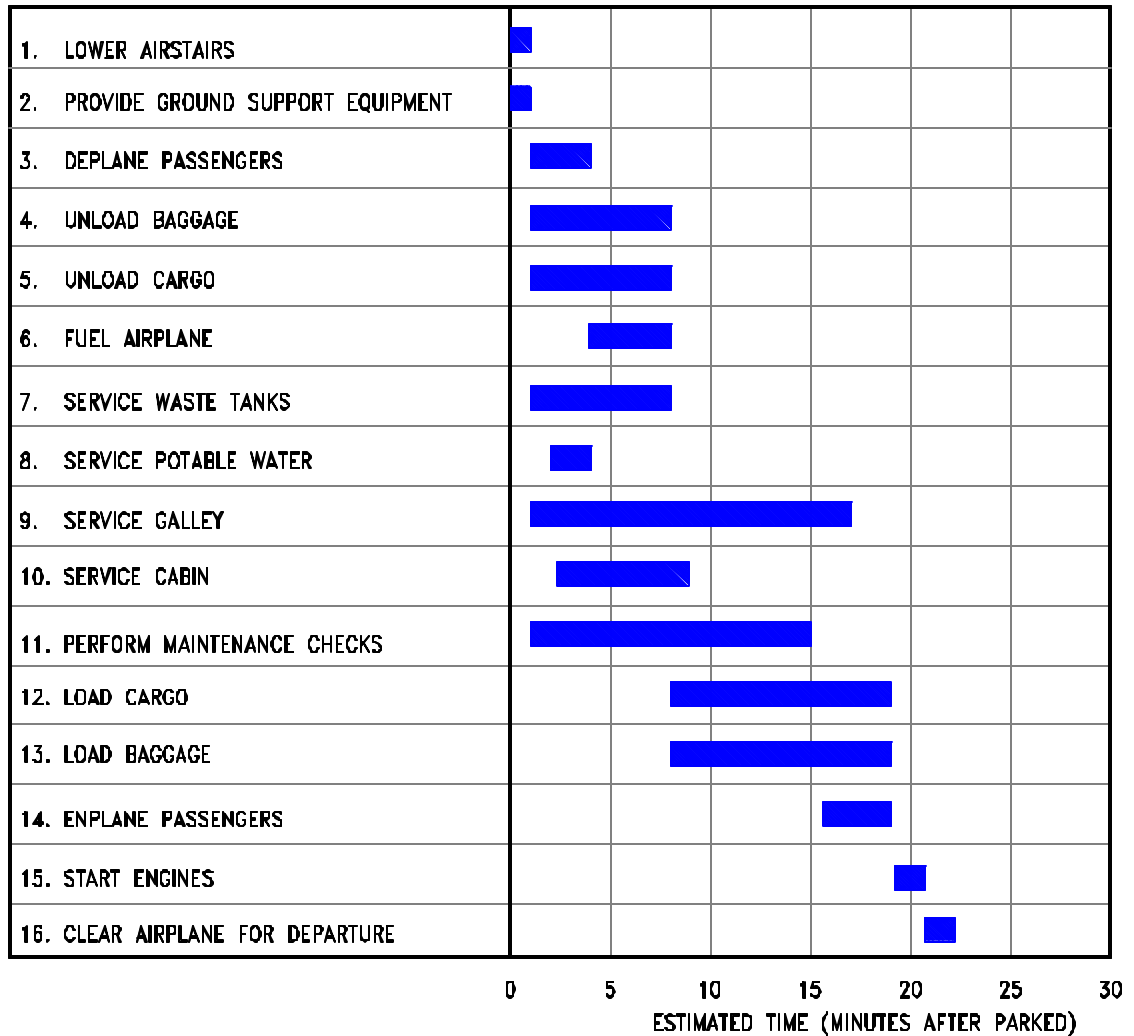

NOTES:

1. ESTIMATES BASED ON MIXED-CLASS CONFIGURATION, 65% LOAD FACTOR
2. IT IS ASSUMED THAT ALL EQUIPMENT FUNCTION PROPERLY AND THAT NO ABNORMAL WEATHER CONDITIONS EXIST.
3. TOTAL TIME ON THE RAMP IS 25 MINUTES
4. BOTH FORWARD AND AFT DOORS ARE USED
5. 75% PASSENGER EXCHANGE
6. THIS DATA IS PROVIDED TO ILLUSTRATE THE GENERAL SCOPE AND TYPES OF TASKS INVOLVED IN TERMINAL OPERATIONS. VARYING AIRLINE PRACTICES AND OPERATING CIRCUMSTANCES THROUGHOUT THE WORLD WILL RESULT IN DIFFERENT SEQUENCES AND TIME INTERVALS TO ACCOMPLISH THE TASKS SHOWN.
7. GROUND OPERATIONS REQUIREMENTS SHOULD BE COORDINATED WITH USING AIRLINES PRIOR TO RAMP PLANNING

5.3.1 TERMINAL OPERATIONS - EN ROUTE STATION

MODEL 737-100, -200, -300, -400, -500

5.3.2 TERMINAL OPERATIONS - EN ROUTE STATION
 MODEL 737-600

D6-58325-6

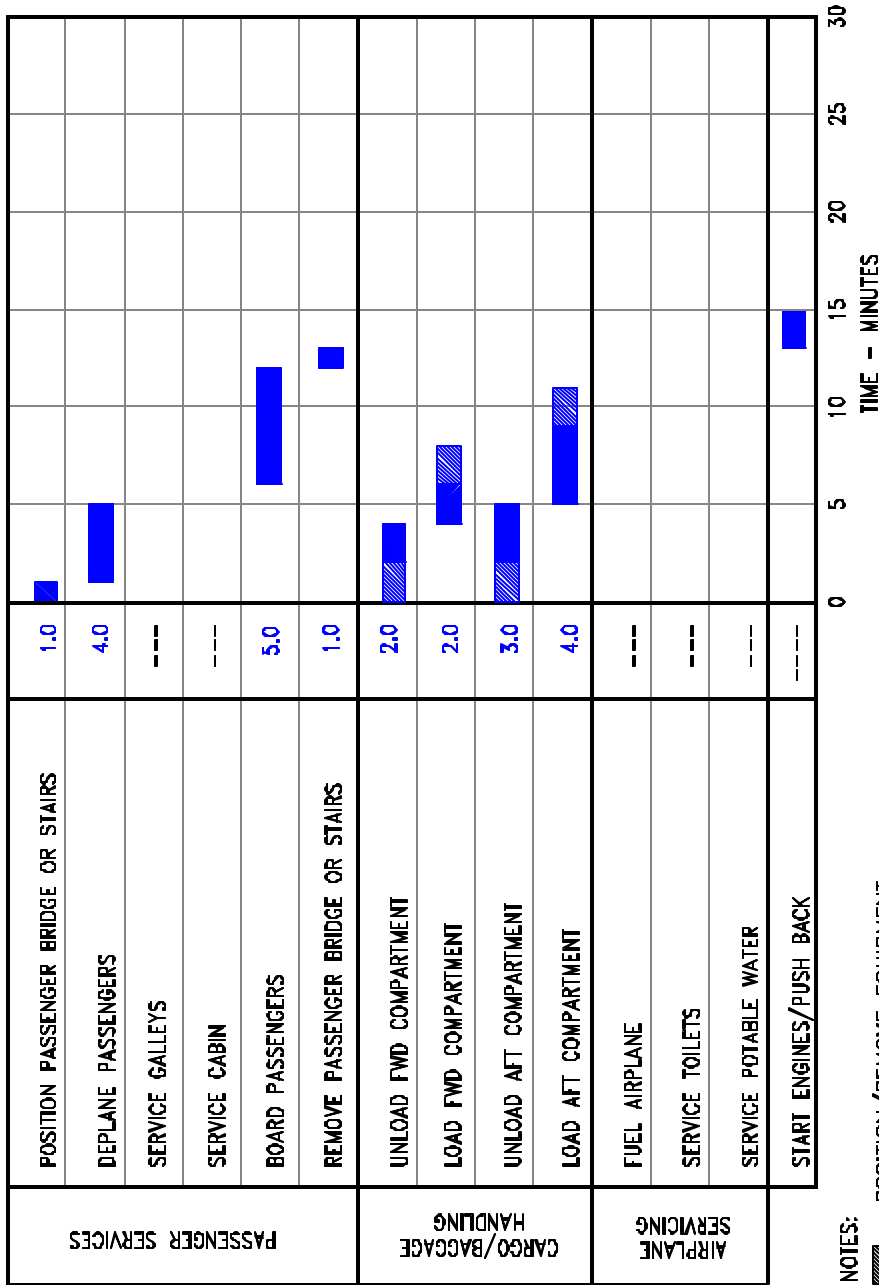

NOTES:

- ▨ POSITION/REMOVE EQUIPMENT
- 100% LOAD FACTOR (108 PASSENGERS)
- 65 PASSENGERS DEPLANE AND BOARD VIA FWD LH ENTRY DOOR
- 60% EXCHANGE OF PASSENGERS AND CARGO
- PASSENGER LOADING RATES:
 - UNLOADING - 18 PAX PER MINUTE
 - LOADING - 12 PAX PER MINUTE
- BAGGAGE LOADING RATES:
 - UNLOADING - 15.0 BAGS PER MINUTE
 - LOADING - 10.0 BAGS PER MINUTE
- 1.0 BAGS PER PAX (4.5 CU FT)
- 23 BAGS FWD/42 BAGS AFT
- 83% STACKING EFFICIENCY

THIS DATA IS PROVIDED TO ILLUSTRATE THE GENERAL SCOPE AND TYPES OF TASKS INVOLVED IN TERMINAL OPERATIONS. VARYING AIRLINE PRACTICES AND OPERATING CIRCUMSTANCES THROUGHOUT THE WORLD WILL RESULT IN DIFFERENT SEQUENCES AND TIME INTERVALS TO ACCOMPLISH THE TASKS SHOWN.

5.3.4 TERMINAL OPERATIONS - EN ROUTE STATION
MODEL 737-800, -800 WITH WINGLETS

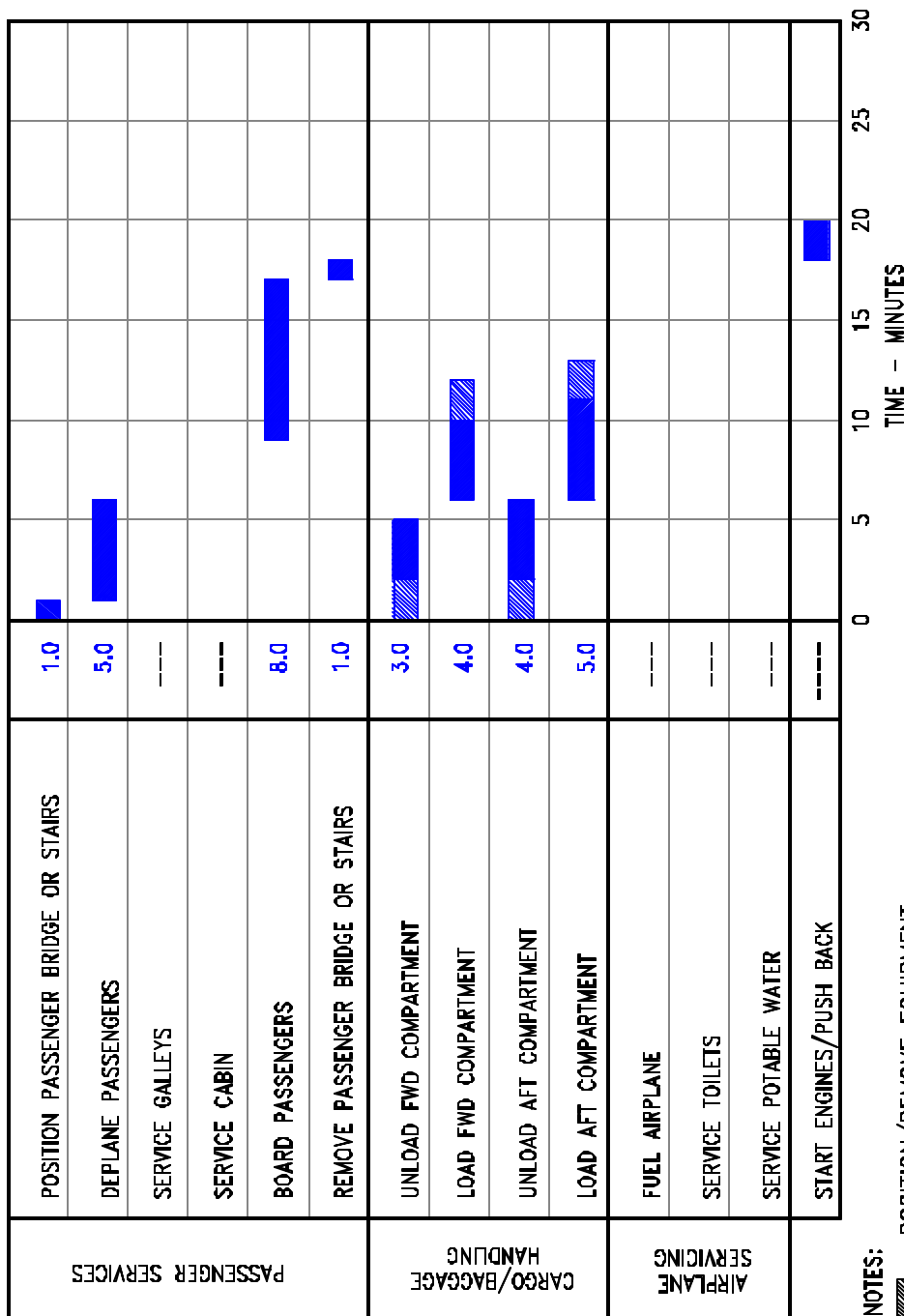

- NOTES:**
- ▨ POSITION/REMOVE EQUIPMENT
 - 100% LOAD FACTOR (160 PASSENGERS)
 - 96 PASSENGERS DEPLANE AND BOARD VIA FWD LH ENTRY DOOR
 - 60% EXCHANGE OF PASSENGERS AND CARGO
 - PASSENGER LOADING RATES:
 - UNLOADING - 18 PAX PER MINUTE
 - LOADING - 12 PAX PER MINUTE
 - BAGGAGE LOADING RATES:
 - UNLOADING - 15.0 BAGS PER MINUTE
 - LOADING - 10.0 BAGS PER MINUTE
 - 1.0 BAGS PER PAX (4.5 CU FT)
 - 41 BAGS FWD/54 BAGS AFT
 - 83% STACKING EFFICIENCY

THIS DATA IS PROVIDED TO ILLUSTRATE THE GENERAL SCOPE AND TYPES OF TASKS INVOLVED IN TERMINAL OPERATIONS. VARYING AIRLINE PRACTICES AND OPERATING CIRCUMSTANCES THROUGHOUT THE WORLD WILL RESULT IN DIFFERENT SEQUENCES AND TIME INTERVALS TO ACCOMPLISH THE TASKS SHOWN.

NOTE

**ENROUTE TERMINAL OPERATIONS TIME CHARTS
ARE NOT INCLUDED IN THIS DOCUMENT
BECAUSE THE DIFFERENT CONFIGURATIONS
OF BOEING BUSINESS JET AIRPLANES
HAVE INDIVIDUAL REQUIREMENTS.
CONSULT AIRCRAFT USER/OPERATOR FOR CURRENT
REQUIREMENTS**

5.3.6 TERMINAL OPERATIONS - ENROUTE STATION
MODEL 737 BBJ, BBJ2

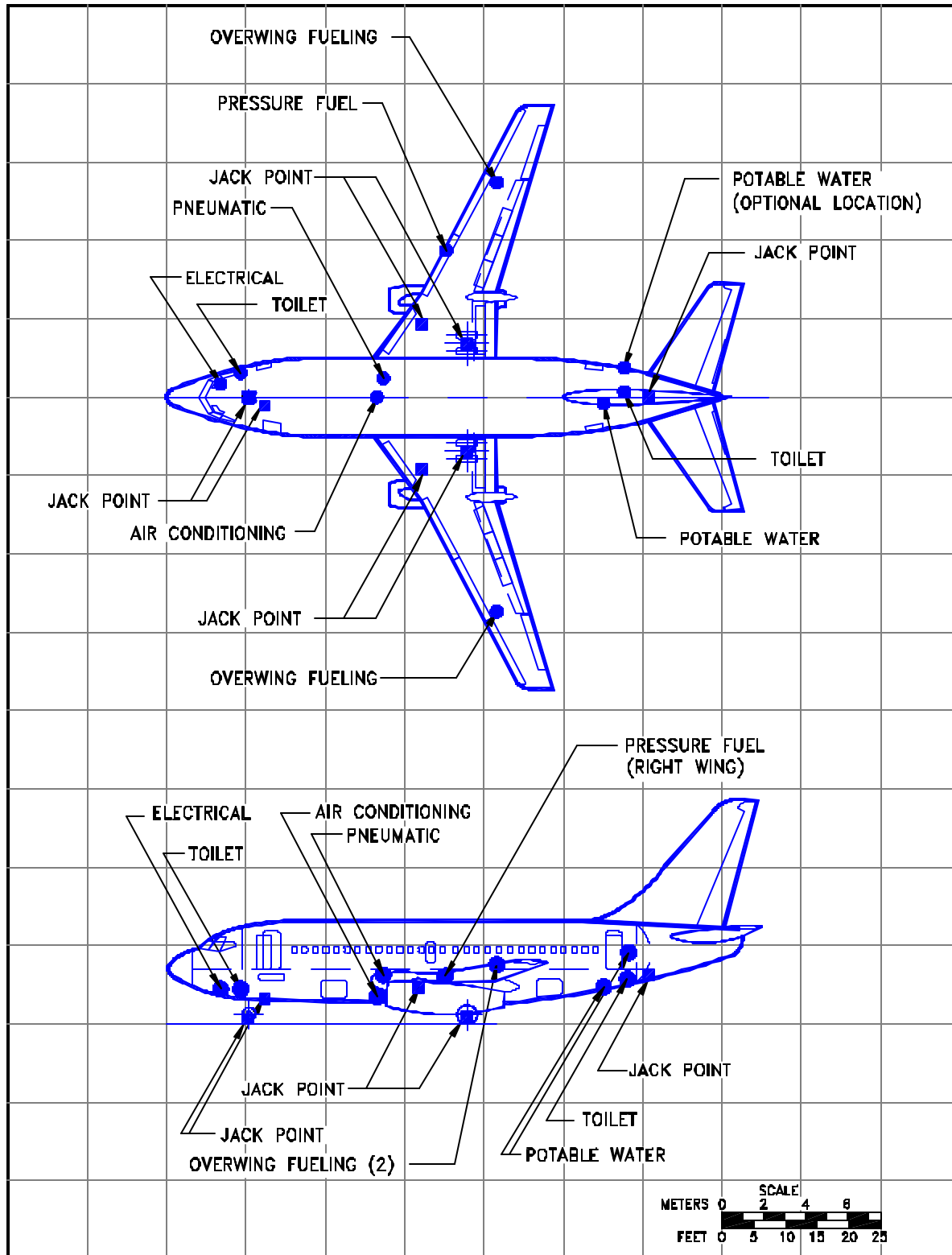

5.4.1 GROUND SERVICING CONNECTIONS
MODEL 737-100

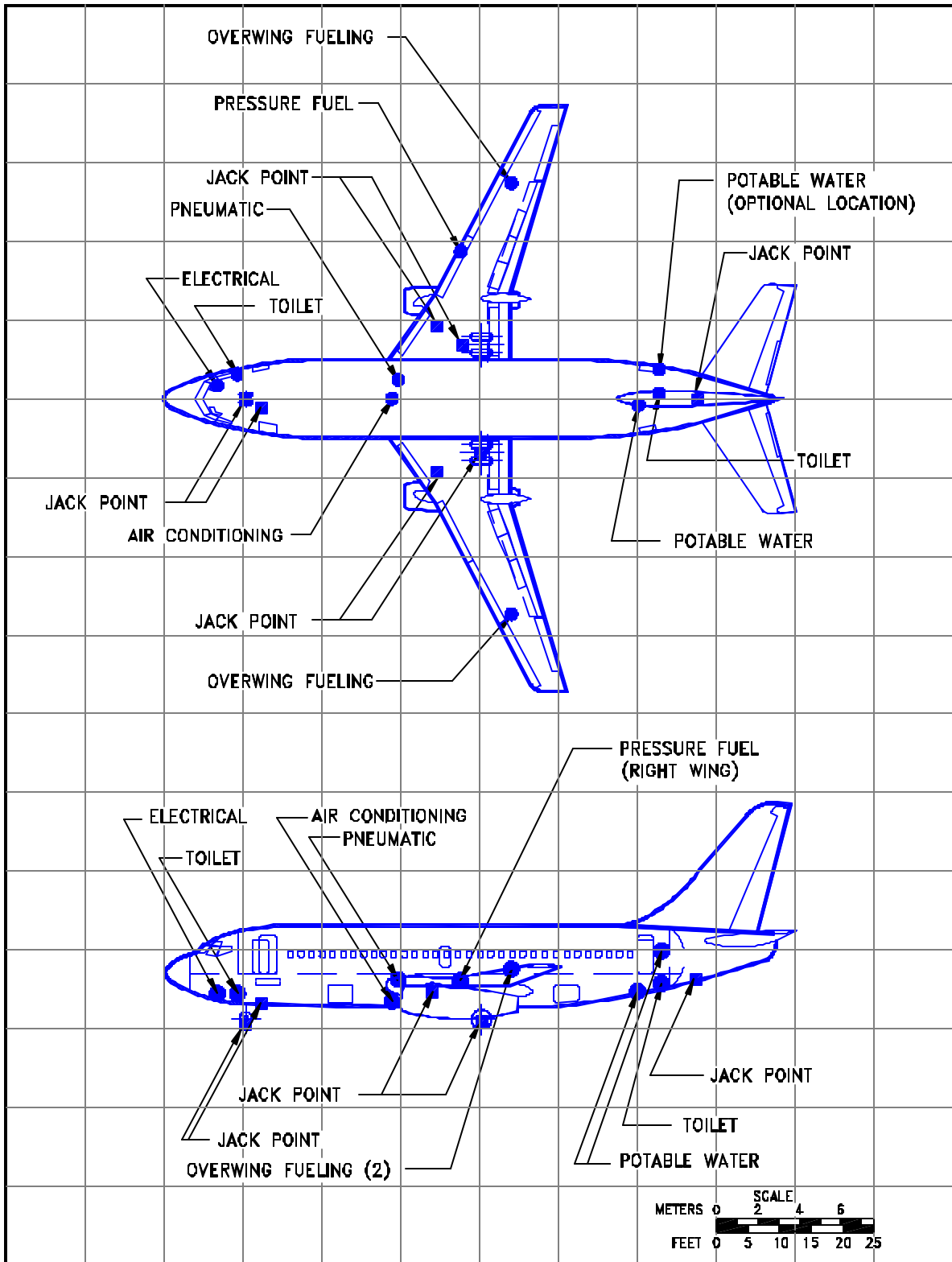

5.4.2 GROUND SERVICING CONNECTIONS
MODEL 737-200

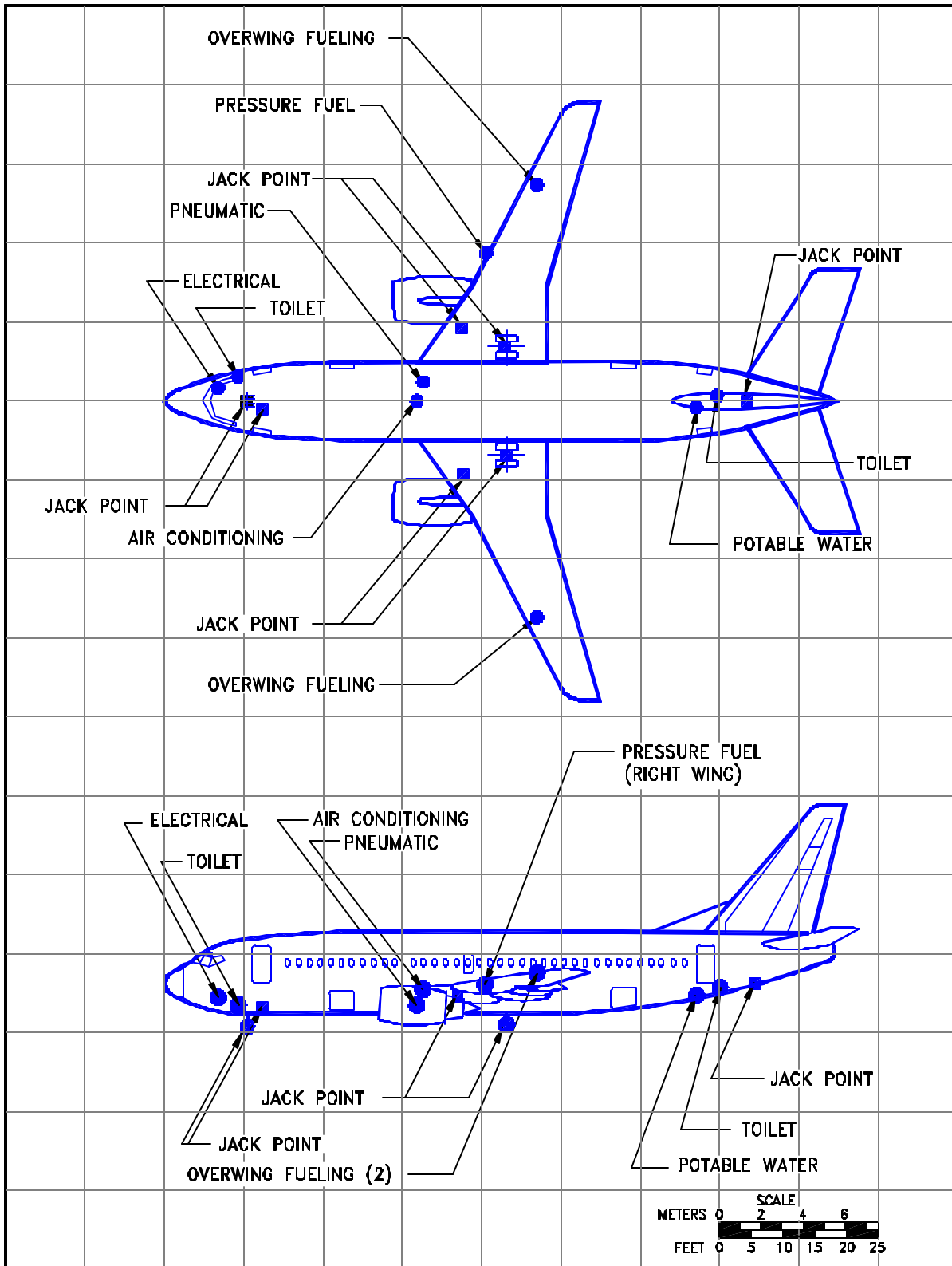

5.4.3 GROUND SERVICING CONNECTIONS
 MODEL 737-300

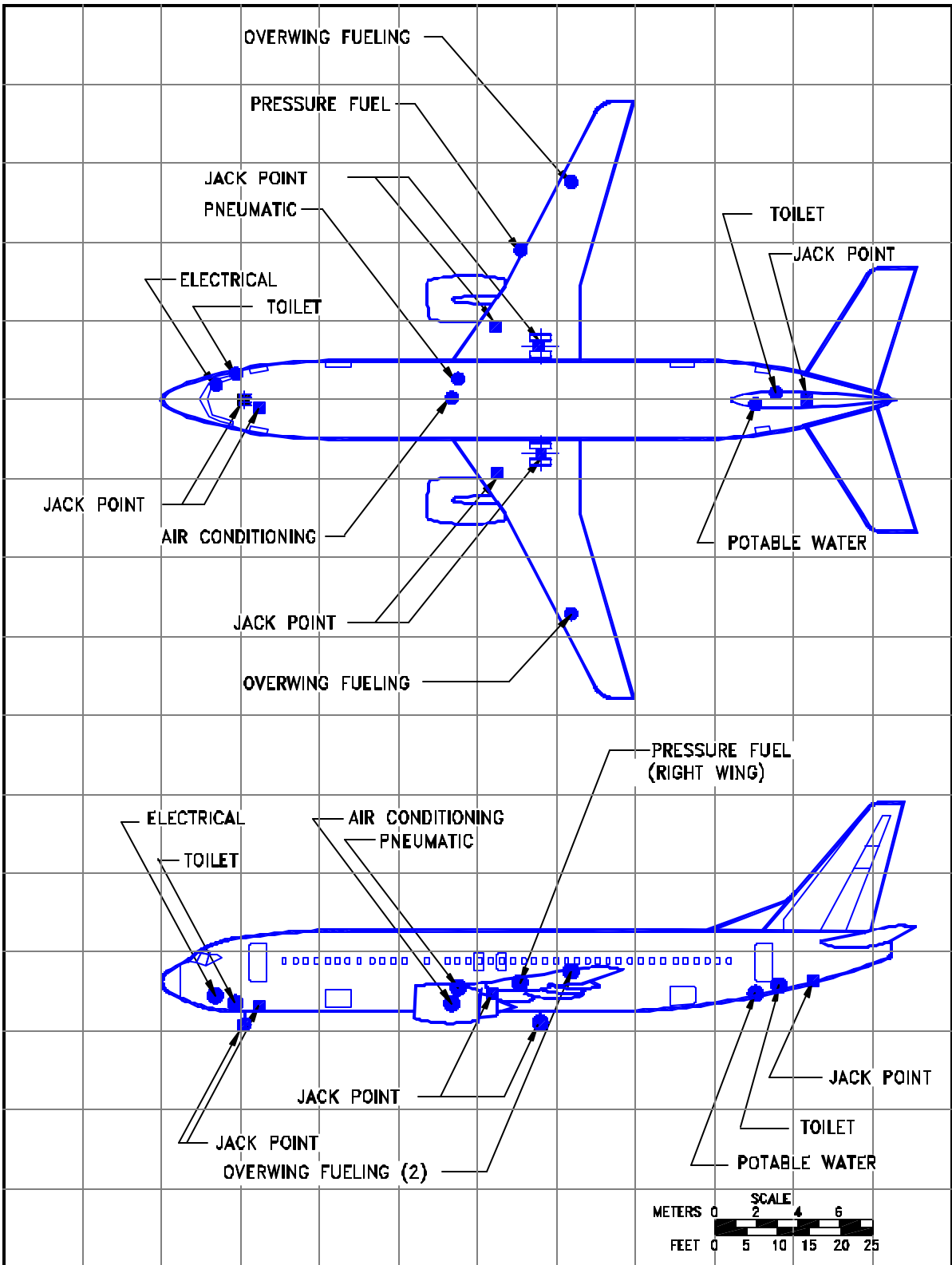

5.4.4 GROUND SERVICING CONNECTIONS
MODEL 737-400

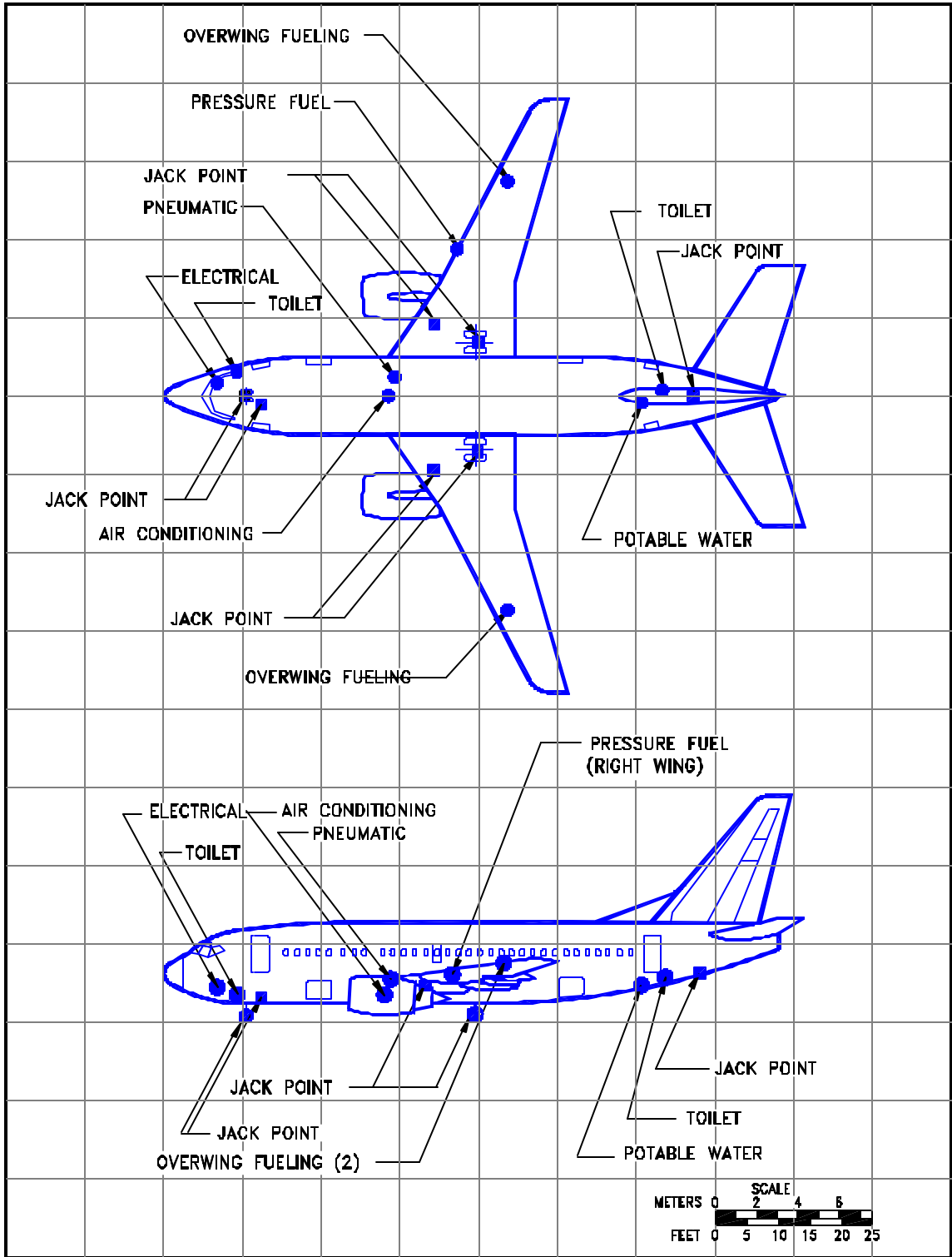

5.4.5 GROUND SERVICING CONNECTIONS
MODEL 737-500

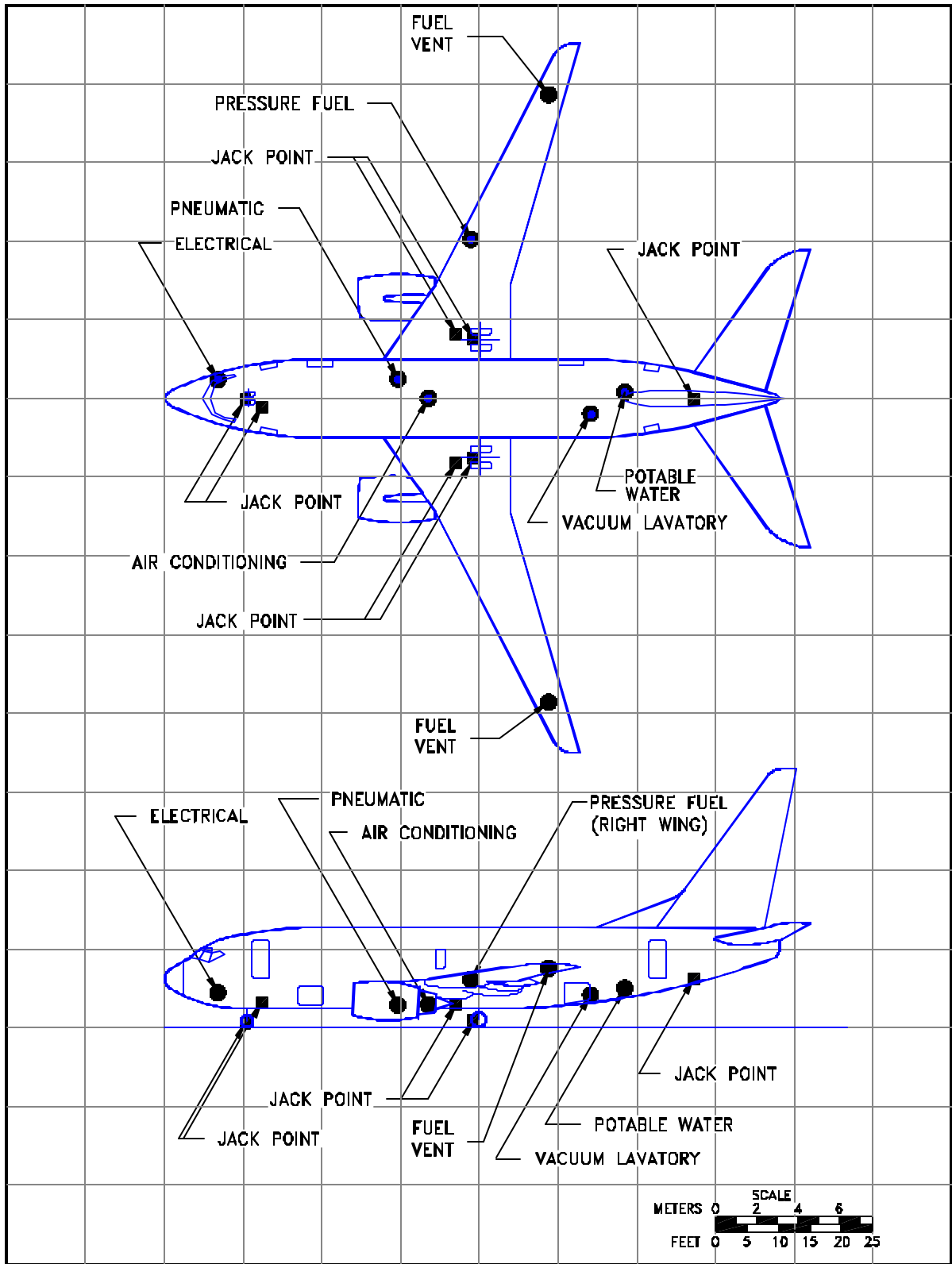

5.4.6 GROUND SERVICING CONNECTIONS
MODEL 737-600

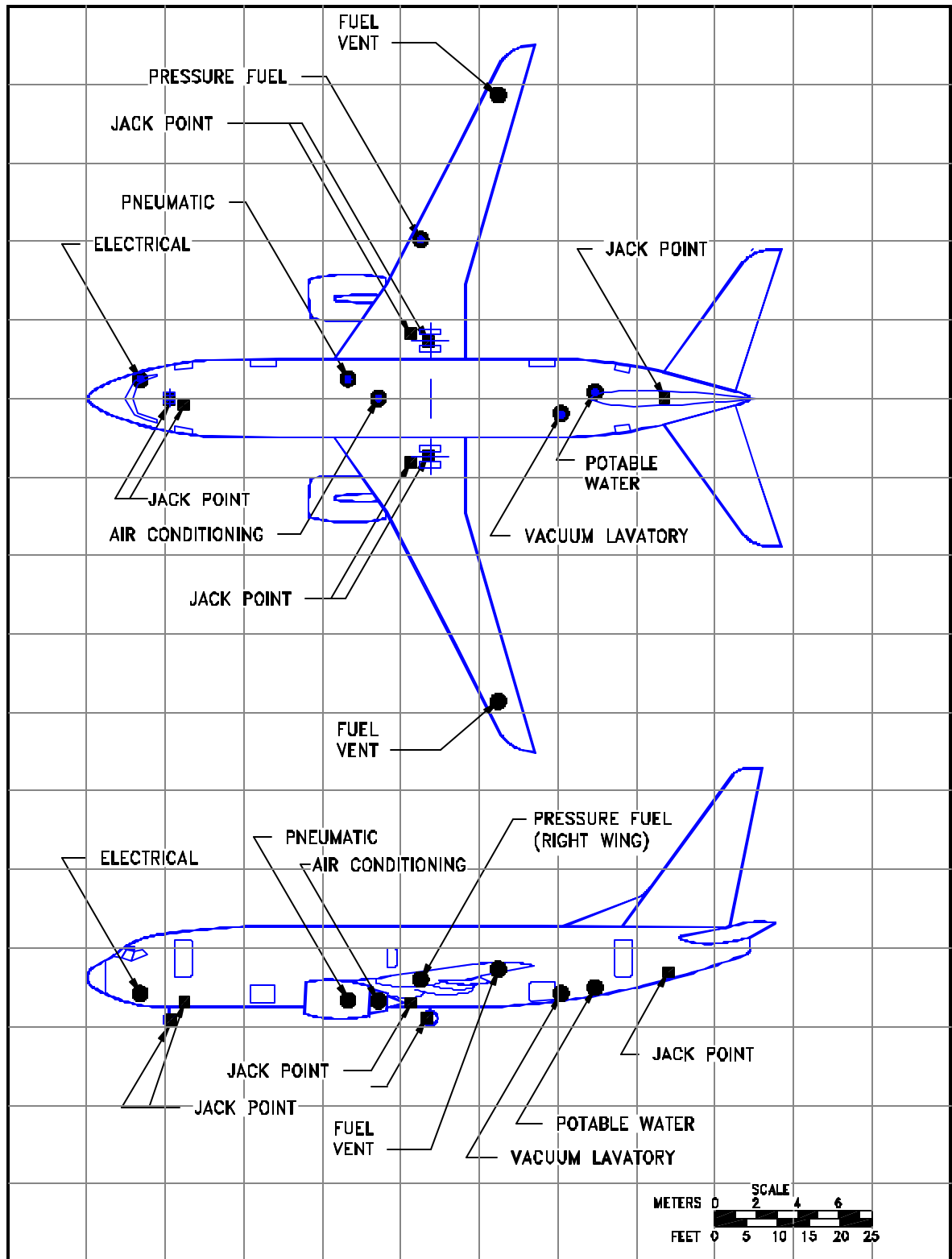

5.4.7 GROUND SERVICING CONNECTIONS
MODEL 737-700

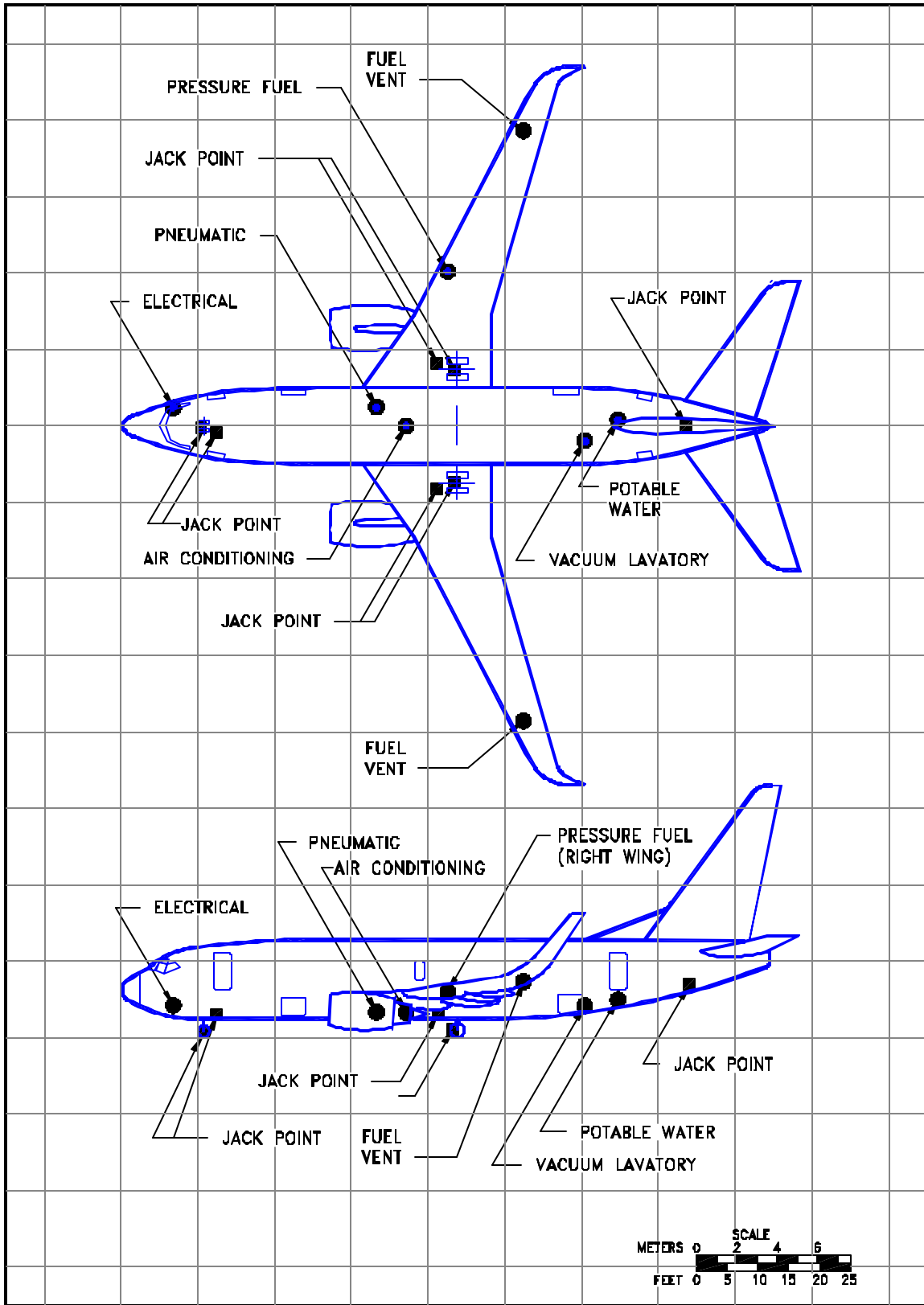

5.4.8 GROUND SERVICING CONNECTIONS
 MODEL 737-700 WITH WINGLETS, 737 BBJ

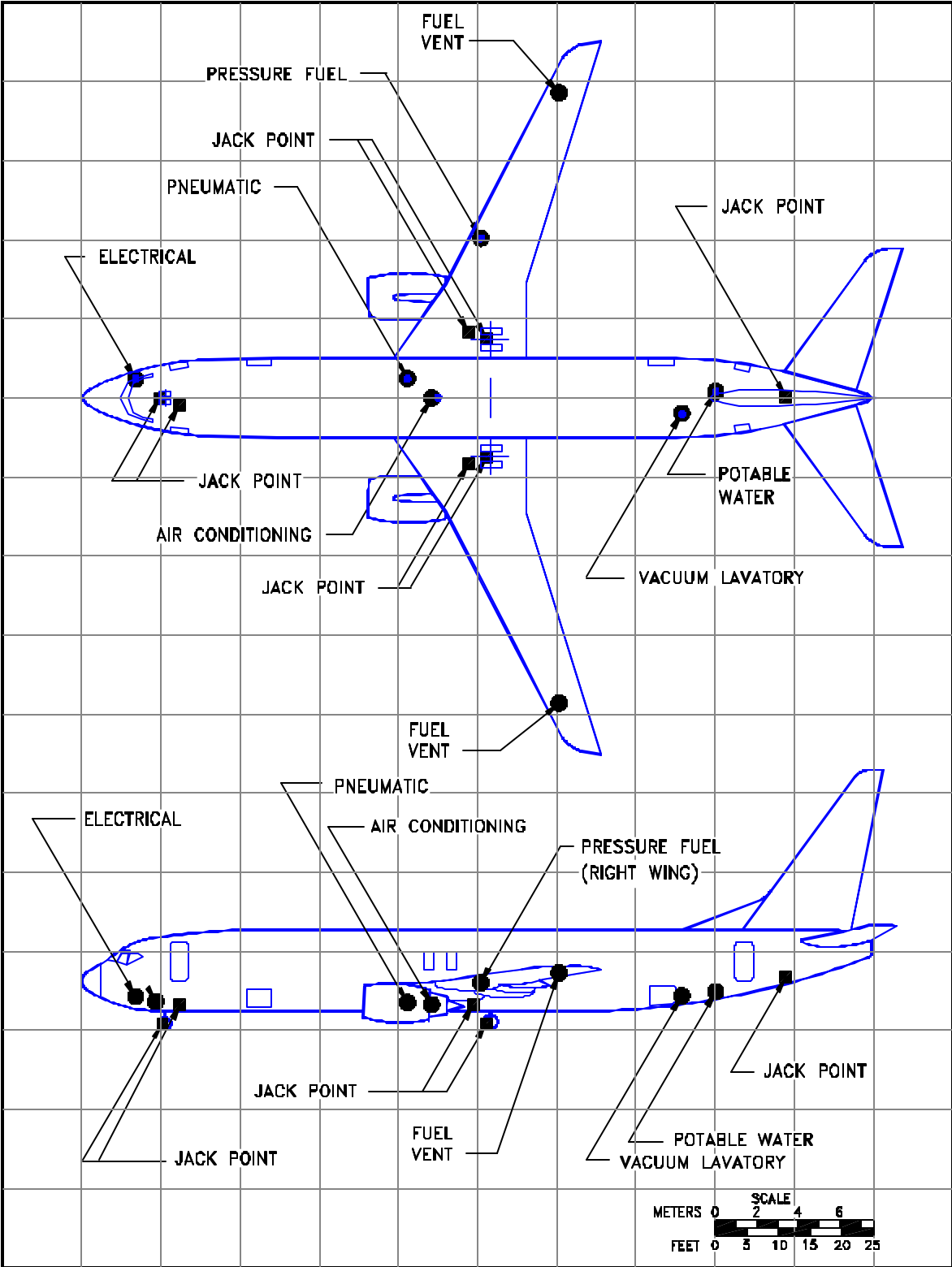

5.4.9 GROUND SERVICING CONNECTIONS
MODEL 737-800

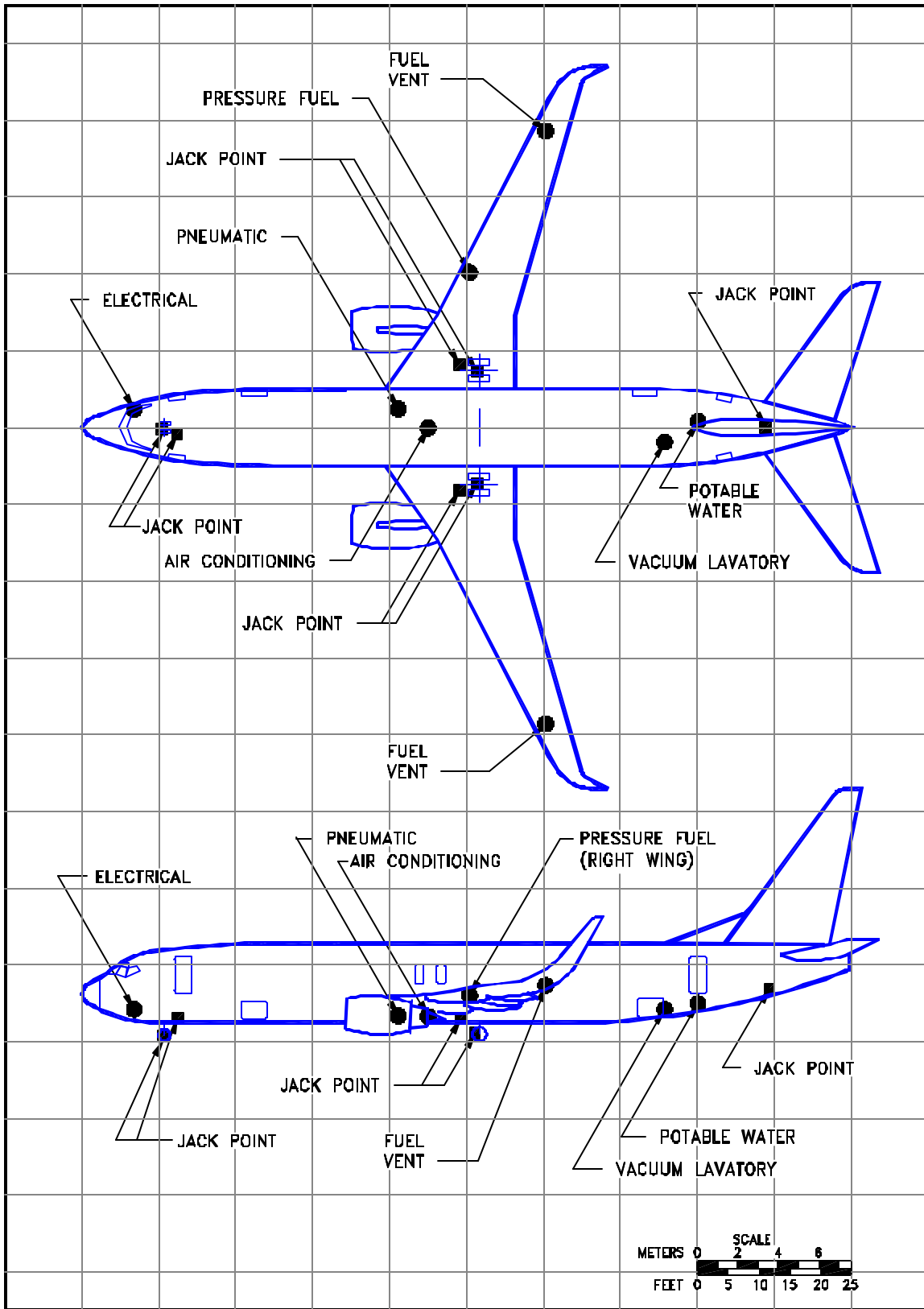

5.4.10 GROUND SERVICING CONNECTIONS
 MODEL 737-800 WITH WINGLETS, 737 BBJ2

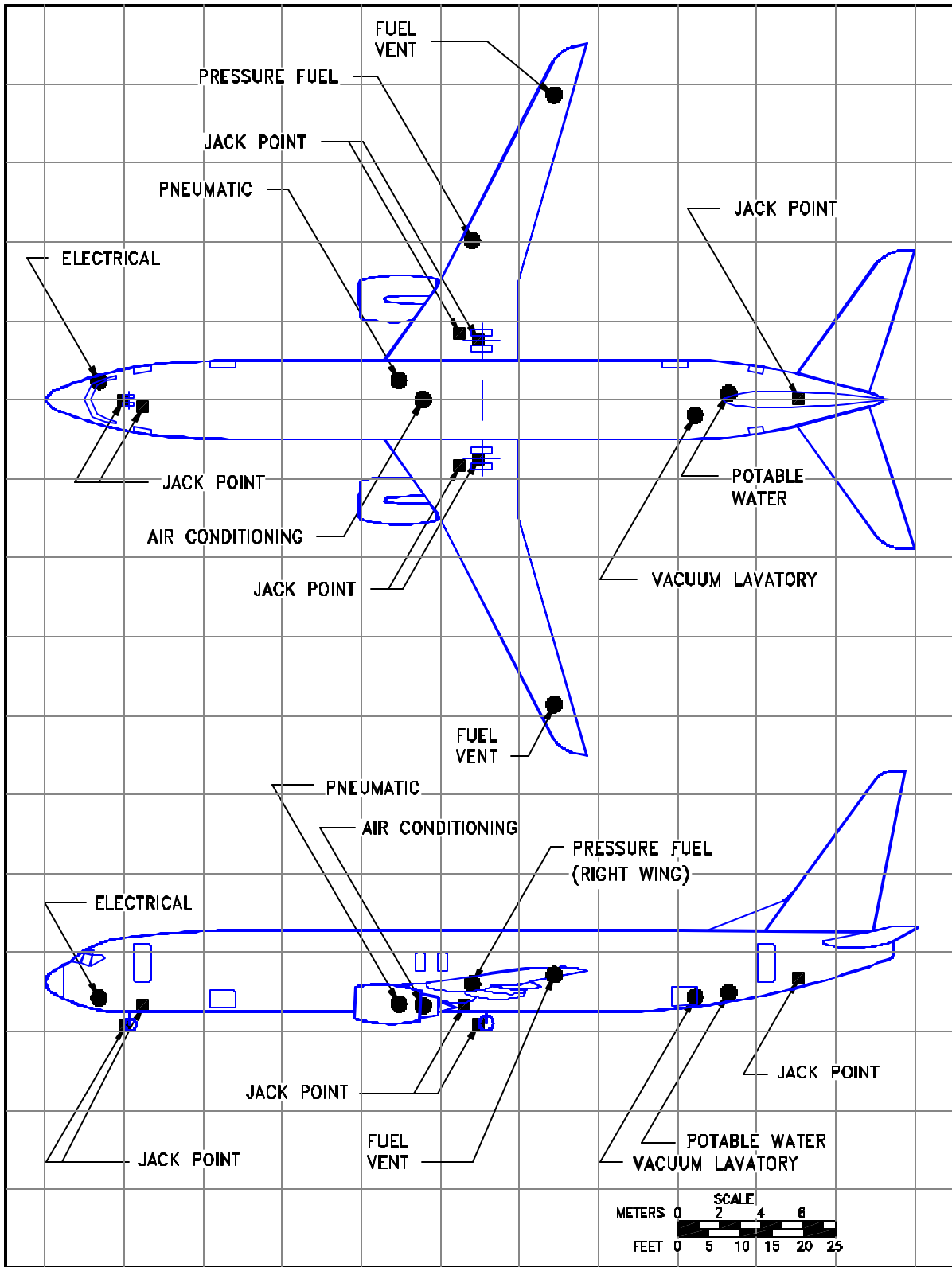

5.4.11 GROUND SERVICING CONNECTIONS
MODEL 737-900, -900ER

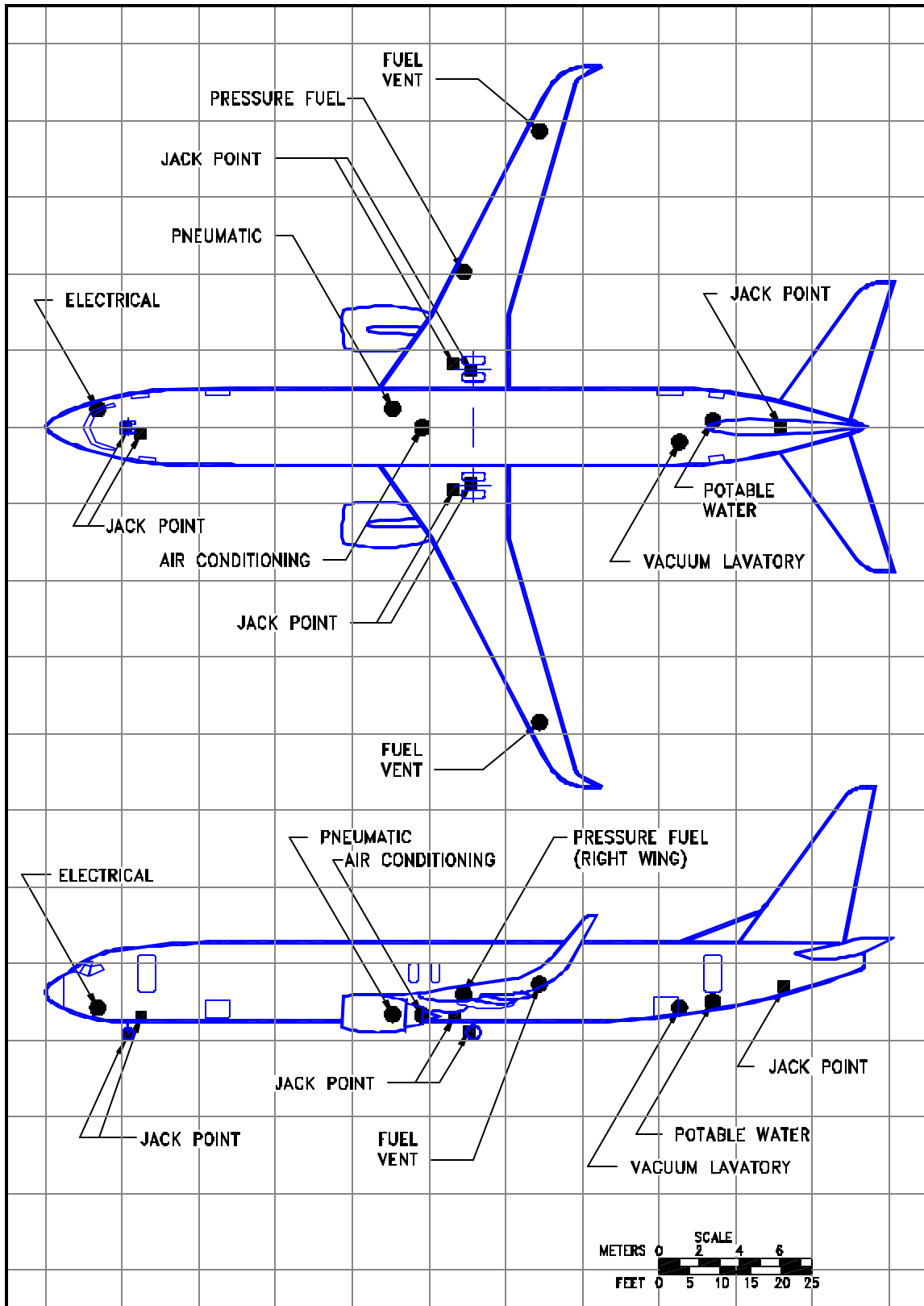

5.4.12 GROUND SERVICING CONNECTIONS
 MODEL 737-900, -900ER WITH WINGLETS

SYSTEM	MODEL	DISTANCE AFT OF NOSE		DISTANCE FROM AIRPLANE CENTERLINE				MAX HEIGHT ABOVE	
		FT-IN	M	LH SIDE		RH SIDE		GROUND	
				FT-IN	M	FT-IN	M	FT-IN	M
CONDITIONED AIR ONE 8-IN (20.3 CM) PORT	737-100	33 - 2	10.1	0	0	0	0	3 - 3	1.0
	737-200	36 - 2	11.0	0	0	0	0	3 - 3	1.0
	737-300	39 - 10	12.1	0	0	0	0	3 - 3	1.0
	737-400	45 - 10	14.0	0	0	0	0	3 - 3	1.0
	737-500	36 - 2	11.0	0	0	0	0	3 - 3	1.0
	737-600	35 - 3	10.7	0	0	0	0	3 - 10	1.2
	737-700	39 - 9	12.1	0	0	0	0	3 - 10	1.2
	737-800	49 - 7	15.1	0	0	0	0	3 - 10	1.2
	737-900	54 - 1	16.5	0	0	0	0	3 - 10	1.2
ELECTRICAL ONE CONNECTION 60 KVA , 200/115 V AC 400 HZ, 3-PHASE EACH	737-100 THRU 737-500	8 - 6	2.6	-	-	2 - 11	0.9	5 - 4	1.6
	737-600 THRU 737-900	8 - 6	2.6	-	-	3 - 1	0.9	6 - 4	1.9
FUEL ONE UNDERWING PRESSURE CONNECTOR ON RIGHT WING (SEE SEC 2.1 FOR CAPACITY)	737-100	44 - 1	13.4	-	-	23 - 6	7.2	8 - 0	2.4
	737-200	47 - 1	14.4	-	-	23 - 6	7.2	8 - 0	2.4
	737-300	50 - 9	15.5	-	-	23 - 6	7.2	8 - 0	2.4
	737-400	56 - 9	17.3	-	-	23 - 6	7.2	8 - 0	2.4
	737-500	47 - 1	14.4	-	-	23 - 6	7.2	8 - 0	2.4
	737-600	48 - 8	14.8	-	-	25 - 3	7.7	9 - 5	2.9
	737-700	53 - 2	16.2	-	-	25 - 3	7.7	9 - 5	2.9
	737-800	63 - 0	19.2	-	-	25 - 3	7.7	9 - 5	2.9
	737-900	67 - 6	20.6	-	-	25 - 3	7.7	9 - 5	2.9
FUEL TWO OVERWING FUEL PORTS	737-100	52 - 1	15.8	34 - 3	10.4	34 - 3	10.4	9 - 4	2.8
	737-200	55 - 1	16.8	34 - 3	10.4	34 - 3	10.4	9 - 4	2.8
	737-300	58 - 9	17.9	34 - 3	10.4	34 - 3	10.4	9 - 4	2.8
	737-400	64 - 9	19.7	34 - 3	10.4	34 - 3	10.4	9 - 4	2.8
	737-500	55 - 1	16.8	34 - 3	10.4	34 - 3	10.4	9 - 4	2.8
FUEL FUEL VENT ON UNDERSIDE OF BOTH WINGTIPS	737-600	61 - 0	18.6	48 - 3	14.7	48 - 3	14.7	UNDERSIDE OF WING	
	737-700	65 - 6	20.0	48 - 3	14.7	48 - 3	14.7		
	737-800	75 - 4	22.0	48 - 3	14.7	48 - 3	14.7		
	737-900	80 - 6	24.5	48 - 3	14.7	48 - 3	14.7		

5.4.13 GROUND SERVICING CONNECTIONS AND CAPACITIES
MODEL 737, ALL MODELS

SYSTEM	MODEL	DISTANCE AFT OF NOSE		DISTANCE FROM AIRPLANE CENTERLINE				MAX HEIGHT ABOVE	
		FT-IN	M	LH SIDE		RH SIDE		GROUND	
				FT-IN	M	FT-IN	M	FT-IN	M
LAVATORY ONE PRESSURE CONNECTION FOR DRAINING, FLUSHING, AND CHEMICAL FILLING - 17 GAL (64.3 L) CAPACITY 10-GPM (37.9 LPM) 20-PSIG (1.4 KG/SQ CM) SERVICE REQUIRED	737-100	11 - 8	3.6	-	-	3 - 10	1.2	5 - 10	1.8
		72 - 2	22.0	-	-	0 - 10	0.3	7 - 10	2.4
	737-200	11 - 8	3.6	-	-	3 - 10	1.2	5 - 10	1.8
		78 - 6	23.9	-	-	0 - 10	0.3	7 - 10	2.4
	737-300	11 - 8	3.6	-	-	3 - 10	1.2	5 - 10	1.8
		88 - 0	26.8	-	-	0 - 10	0.3	7 - 10	2.4
	737-400	11 - 8	3.6	-	-	3 - 10	1.2	5 - 10	1.8
		98 - 0	29.9	-	-	0 - 10	0.3	7 - 10	2.4
	737-500	11 - 8	3.6	-	-	3 - 10	1.2	5 - 10	1.8
		78 - 6	23.9	-	-	0 - 10	0.3	7 - 10	2.4
LAVATORY ONE CONNECTION FOR VACUUM LAVATORY	737-600	67 - 9	20.7	2 - 7	0.8	-	-	5 - 10	1.8
	737-700	75 - 7	23.1	2 - 7	0.8	-	-	5 - 10	1.8
	737-800	94 - 9	28.9	2 - 7	0.8	-	-	5 - 11	1.8
	737-900	102 - 9	31.3	2 - 7	0.8	-	-	5 - 11	1.8
OXYGEN ONE SERVICE CONNECTION FOR OXYGEN FILL - 153 CU FT (4.3 CU M) AT 3,000 PSIG (211 KG/SQ CM) OR 190 CU FT (5.4 CU M) WITH SECOND OBSERVER SEAT.	737-100	21 - 8	6.6	-	-	5 - 0	1.5	6 - 3	1.9
	737-200	21 - 8	6.6	-	-	5 - 0	1.5	6 - 3	1.9
OXYGEN INDIVIDUAL CANISTERS IN EACH PASSENGER SERVICE UNIT	737-300 THRU 737-900								
PNEUMATIC ONE 3-IN (7.6-CM) PORT FOR ENGINE START AND AIRCONDITIONING PACKS	737-100	34 - 2	10.4	-	-	3 - 0	0.9	3 - 8	1.2
	737-200	37 - 3	11.3	-	-	3 - 0	0.9	3 - 8	1.2
	737-300	40 - 10	12.5	-	-	3 - 0	0.9	3 - 8	1.2
	737-400	46 - 10	14.3	-	-	3 - 0	0.9	3 - 8	1.2
	737-500	37 - 2	11.3	-	-	3 - 0	0.9	3 - 8	1.2
	737-600	37 - 1	11.3	-	-	3 - 0	0.9	4 - 2	1.3
	737-700	41 - 7	12.7	-	-	3 - 0	0.9	4 - 3	1.3
	737-800	51 - 5	15.7	-	-	3 - 0	0.9	4 - 3	1.3
	737-900	55 - 11	17.1	-	-	3 - 0	0.9	4 - 3	1.3

5.4.14 GROUND SERVICING CONNECTIONS AND CAPACITIES
MODEL 737, ALL MODELS

SYSTEM	MODEL	DISTANCE AFT OF NOSE		DISTANCE FROM AIRPLANE CENTERLINE				MAX HEIGHT ABOVE GROUND	
		FT-IN	M	LH SIDE		RH SIDE		FT-IN	M
				FT-IN	M	FT-IN	M		
POTABLE WATER TWO SERVICE CONNECTIONS 0.75-IN (1.9 CM) AFT LOCATION OPTIONAL	737-100	68 - 11	21.0	1 - 0	0.3	-	-	6 - 4	1.9
	737-200	72 - 1	22.0	-	-	4 - 8	1.4	10 - 4	3.2
		75 - 3	22.9	1 - 0	0.3	-	-	6 - 4	1.9
		78 - 6	23.9	-	-	4 - 8	1.4	10 - 4	3.2
POTABLE WATER ONE SERVICE CONNECTION 0.75-IN (1.9 CM)	737-300	84 - 9	25.8	1 - 0	0.3	4 - 8	1.4	10 - 4	3.2
	737-400	94 - 9	28.9	1 - 0	0.3	4 - 8	1.4	10 - 4	3.2
	737-500	75 - 3	22.9	1 - 0	0.3	4 - 8	1.4	10 - 6	3.2
	737-600	73 - 1	22.3	-	-	1 - 0	0.3	6 - 4	1.9
	737-700	80 - 11	24.7	-	-	1 - 0	0.3	6 - 4	1.9
	737-800	100 - 1	30.5	-	-	1 - 0	0.3	6 - 5	2.0
	737-900	108 - 1	33.9	-	-	1 - 0	0.3	6 - 5	2.0

NOTES:

- DISTANCES ROUNDED TO THE NEAREST INCH AND 0.1 METER.
- AIRPLANE MODEL DESIGNATIONS ALSO INCLUDE ALL DERIVATIVES.

5.4.15 GROUND SERVICING CONNECTIONS AND CAPACITIES

MODEL 737, ALL MODELS

D6-58325-6

NOTES:

- * JT8D ENGINES
- * MINIMUM STARTING REQUIREMENTS
- * SEA LEVEL
- * COORDINATE WITH USING AIRLINE FOR SPECIFIC PLANNED OPERATING PROCEDURES

EXAMPLE:

AMBIENT TEMPERATURE = 59°F (15°C)
 GROUND CONNECTION TEMPERATURE = 250°F (121°C)
 REQUIRED PRESSURE AT GROUND CONNECTION = 47 PSIA (3.30 KG/SQ CM ABS)
 REQUIRED AIRFLOW AT GROUND CONNECTION = 77 LB/MIN (34.9 KGM/MIN)

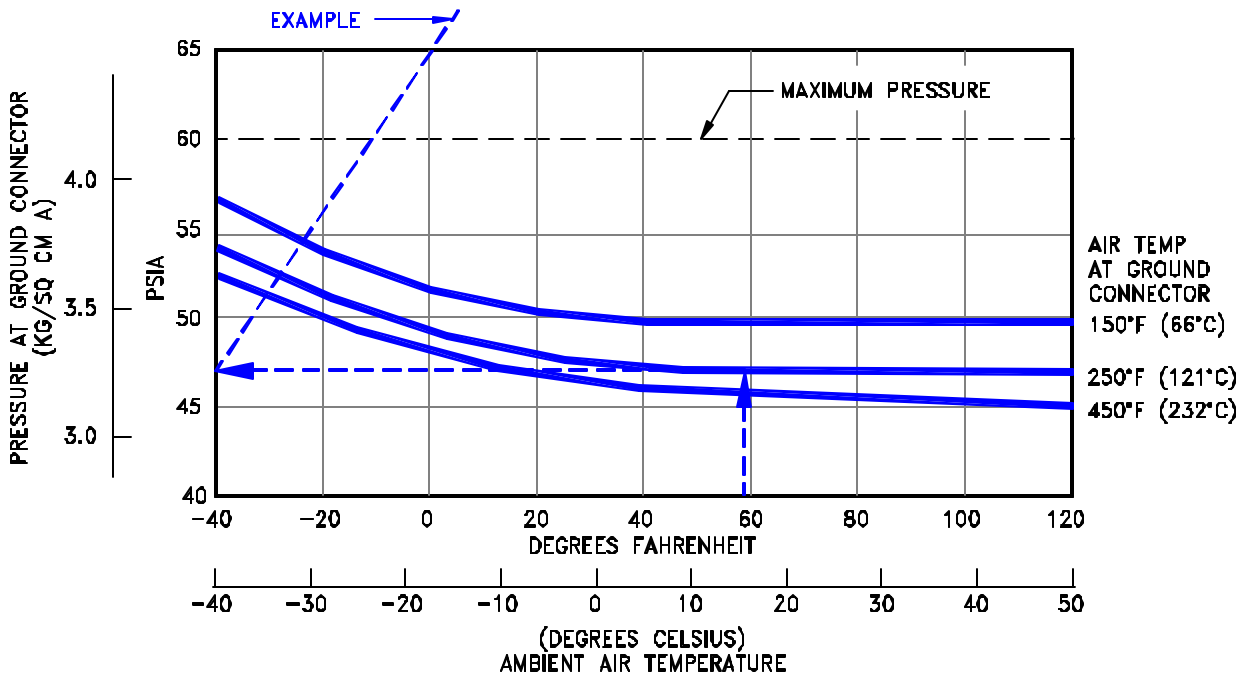
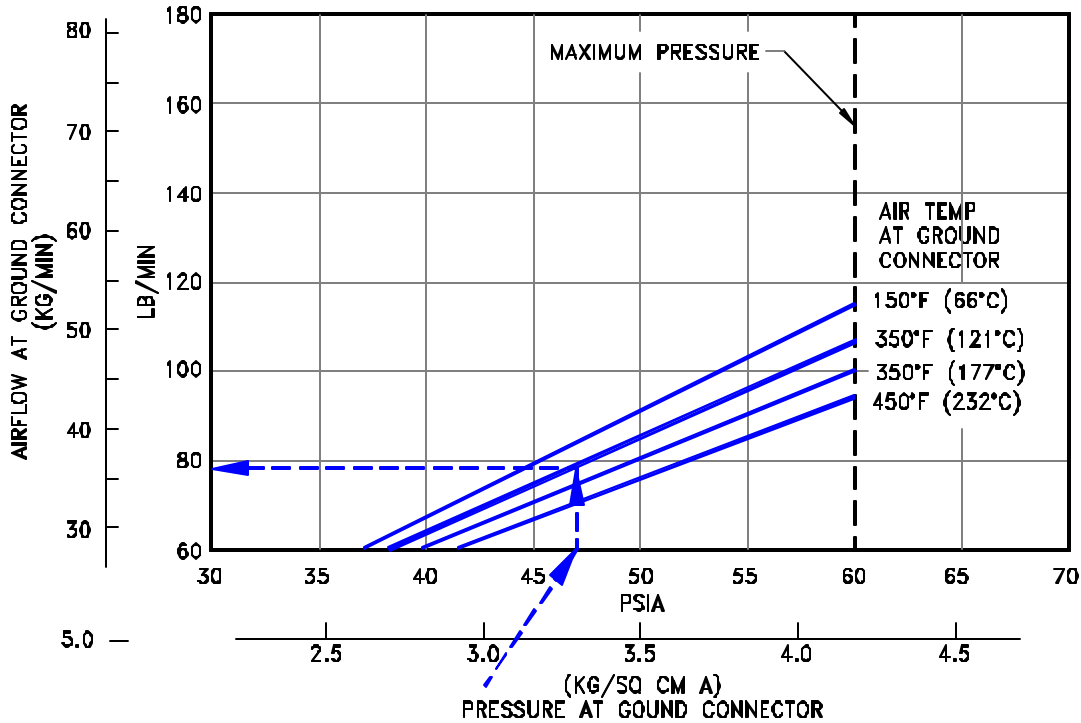

5.5.1 ENGINE START PNEUMATIC REQUIREMENTS - SEA LEVEL

MODEL 737-100, -200

NOTES:

- * CFM56-3 ENGINES
- * MINIMUM STARTING REQUIREMENTS
- * SEA LEVEL
- * COORDINATE WITH USING AIRLINE FOR SPECIFIC PLANNED OPERATING PROCEDURES

EXAMPLE:

AMBIENT TEMPERATURE = 59°F (15°C)
 GROUND CONNECTION TEMPERATURE = 200°F (93°C)
 REQUIRED PRESSURE AT GROUND CONNECTION = 52.5 PSIA (3.69 KG/SQ CM ABS)
 REQUIRED AIRFLOW AT GROUND CONNECTION = 120 LB/MIN (54.4 KGM/MIN)

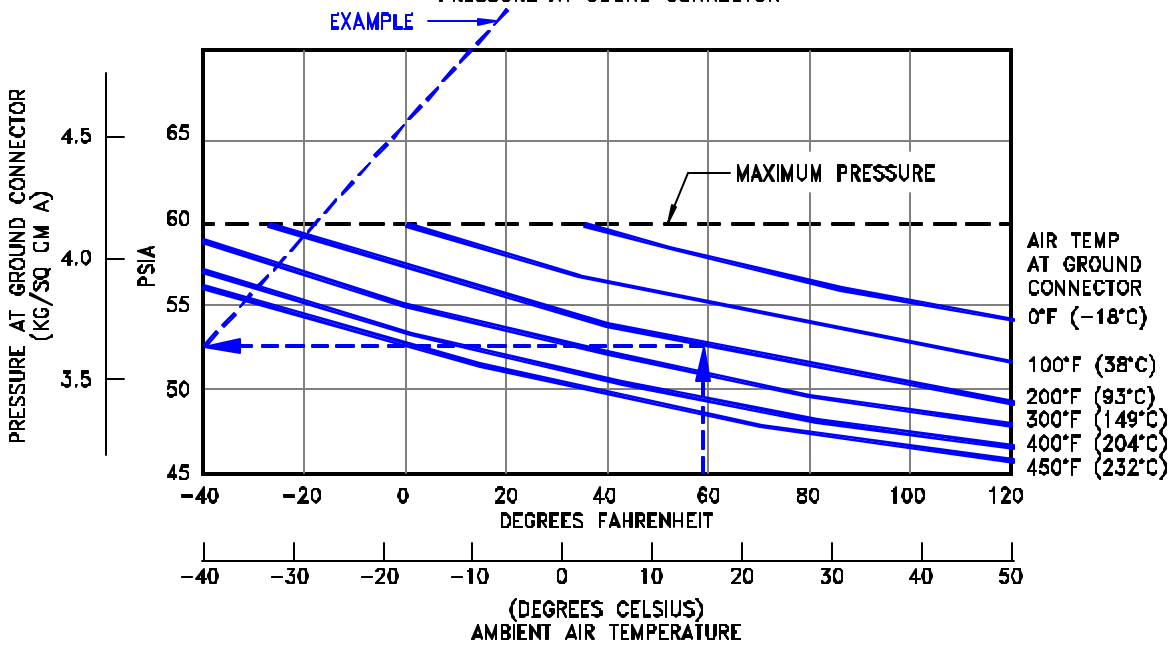
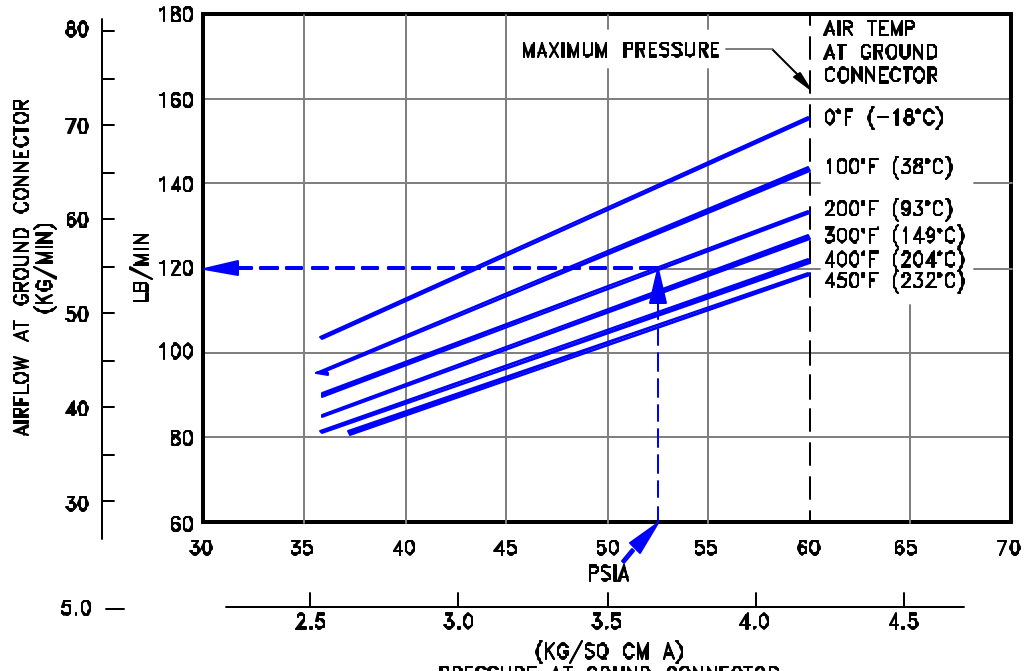

5.5.2 ENGINE START PNEUMATIC REQUIREMENTS - SEA LEVEL

MODEL 737-300, -400, -500

NOTES:

- MINIMUM STARTING REQUIREMENTS
- SEA LEVEL
- COORDINATE WITH USING AIRLINES FOR SPECIFIC PLANNED OPERATING PROCEDURES

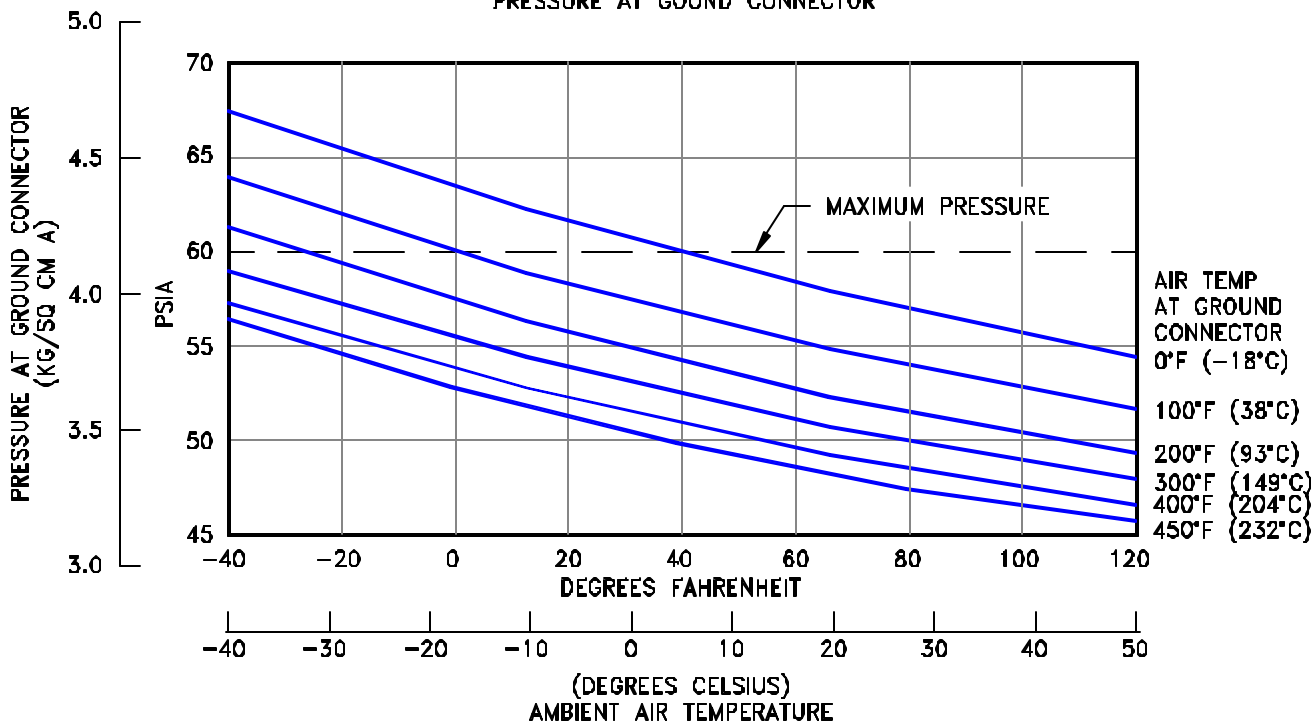
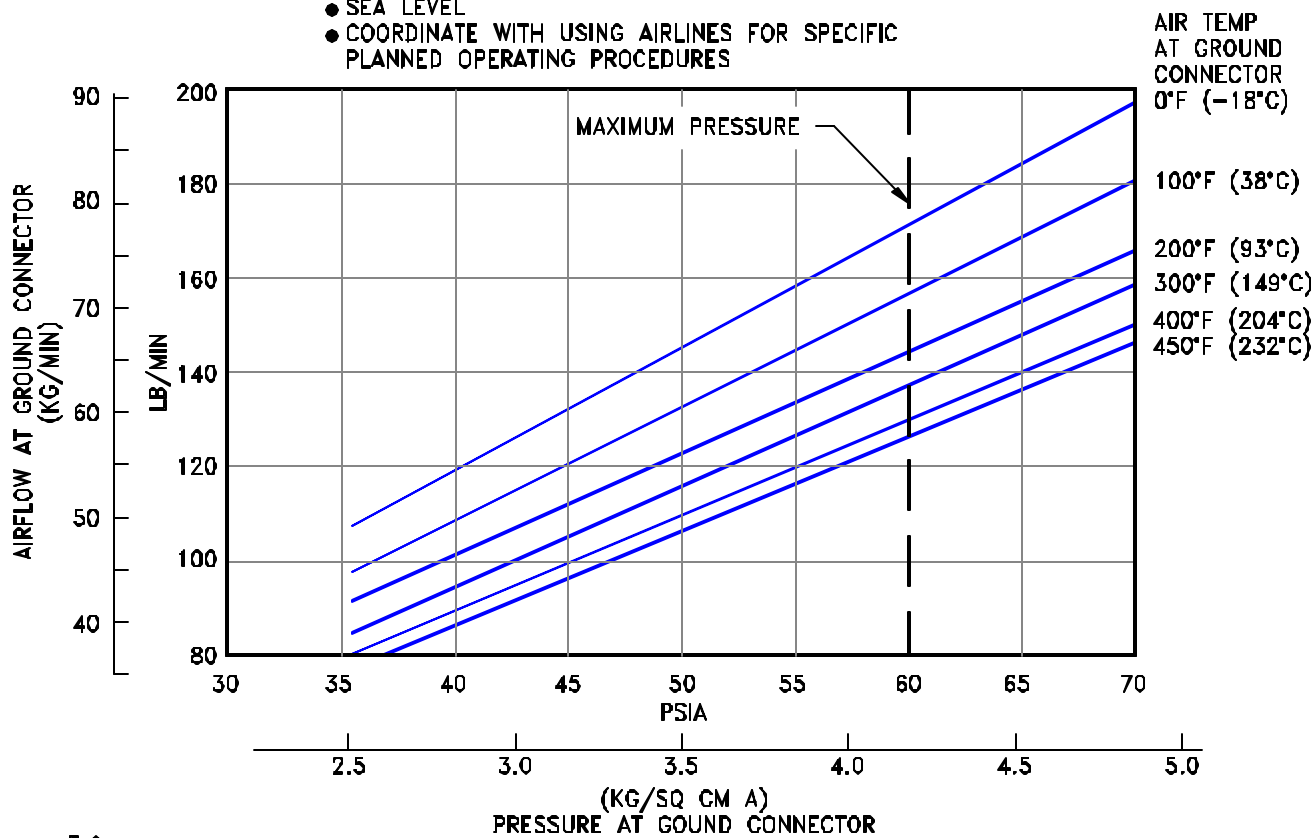

5.5.3 ENGINE START PNEUMATIC REQUIREMENTS - SEA LEVEL

MODEL 737-600, -700, -800, -900, 737 BBJ, 737 BBJ2

- HEATING (PULL-UP)
 * INITIAL CABIN TEMPERATURE: 0°F (-17.9°C)
 * NO GALLEY LOAD
 * NO ELECTRICAL LOAD
 * $W_{CART} = 1.23xW$
 * P = PRESSURE AT GROUND CONNECTION
 * TEMP AT GROUND CONNECTION = 200°F (93°C) TO 450°F (232°C)

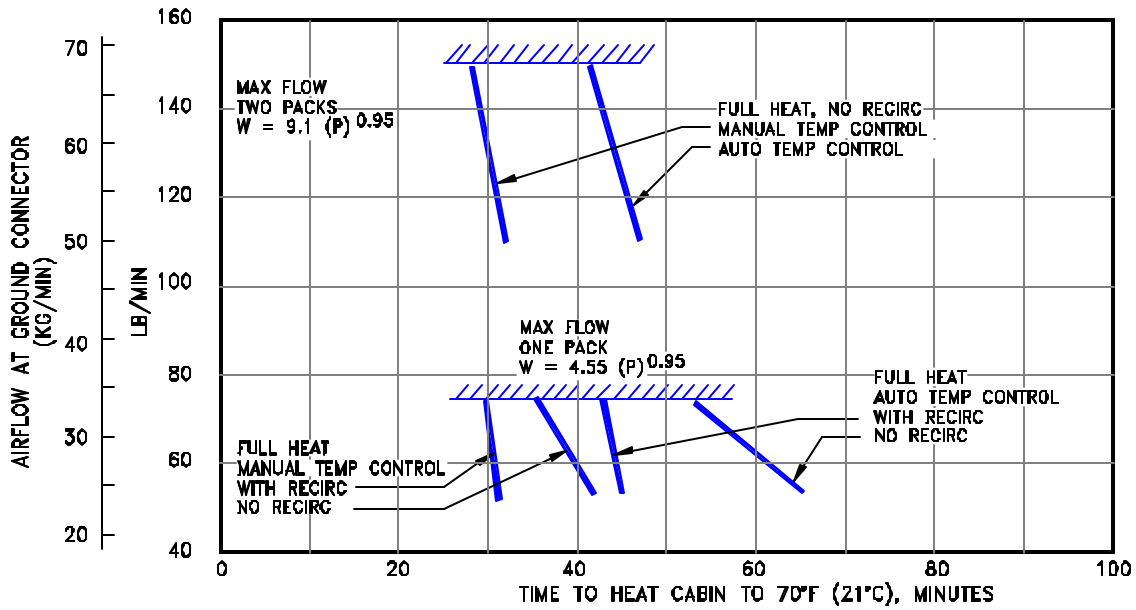

- COOLING (PULL-DOWN)
 * INITIAL CABIN TEMPERATURE: 103°F (39.5°C)
 * OUTSIDE AIR TEMPERATURE: 103°F (39.5°C)
 * SOLAR LOAD: 4,800 BTU/HR (1,210 KCAL/HR)
 * NO GALLEY LOAD
 * TEMPERATURE AT GROUND CONNECTION LESS THAN 450°F (232°C)
 * $W_{CART} = 1.26xW$
 * P = PRESSURE AT GROUND CONNECTION, PSIG
 * NO ELECTRICAL LOAD
 * RH = RELATIVE HUMIDITY

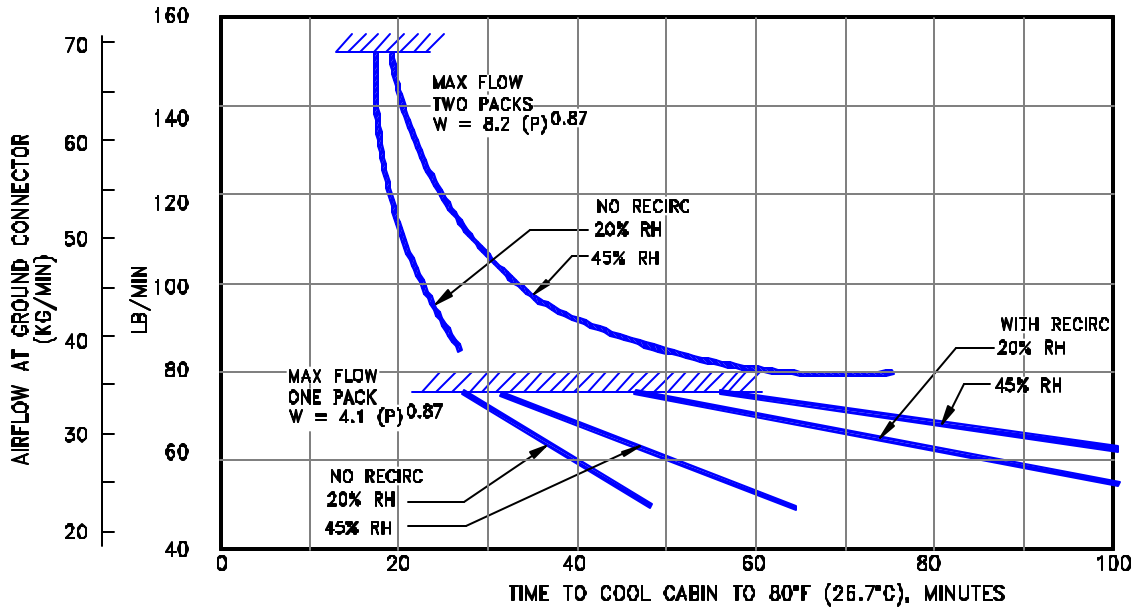

5.6.1 GROUND PNEUMATIC POWER REQUIREMENTS - HEATING/COOLING

MODEL 737-100, -200

HEATING (PULL-UP)

- INITIAL CABIN TEMPERATURE - 0°F (-18°C)
- NO GALLEY LOAD
- NO ELECTRICAL LOAD
- $W_{CART} = 1.23 \times W$
- P = PRESSURE AT GROUND CONNECTION
- TEMP AT GROUND CONNECTION 200°F (66°C) TO 450°F (323°C)

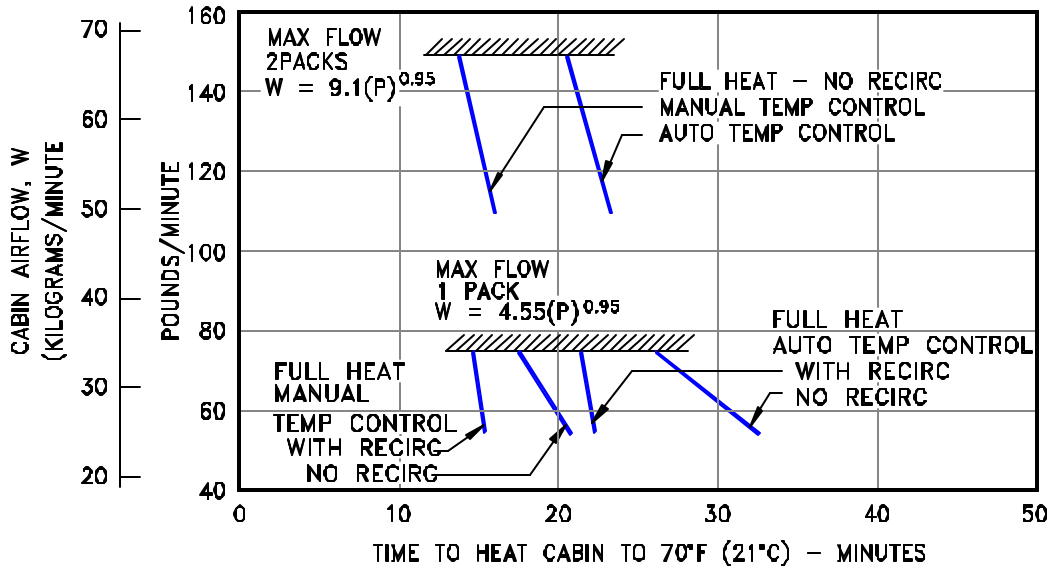

COOLING (PULLDOWN)

- INITIAL CABIN TEMPERATURE - 103°F (39°C)
- OUTSIDE AIR TEMPERATURE - 103°F (39°C)
- SOLAR LOAD - 4,800 BTU/HR (1,210 KCAL/HR)
- NO GALLEY LOAD
- TEMP AT GROUND CONNECTION - LESS THAN 450°F (232°C)
- $W_{CART} = 1.26 \times W$
- P = PRESSURE AT GROUND CONNECTION, PSIG
- NO ELECTRICAL LOAD
- RH = RELATIVE HUMIDITY

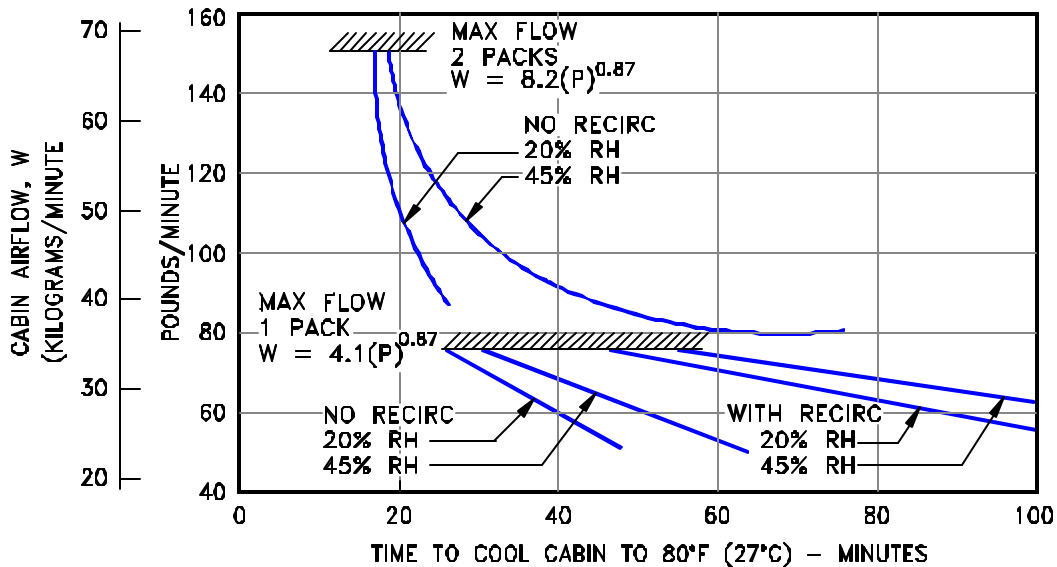

5.6.2 GROUND PNEUMATIC POWER REQUIREMENTS - HEATING/COOLING

MODEL 737-300, -500

HEATING (PULL-UP)
 * INITIAL CABIN TEMPERATURE: 0°F (-17.9°C)
 * OUTSIDE AIR TEMPERATURE: 0°F (-17.9°C)
 * NO GALLEY LOAD, NO ELECTRICAL LOAD
 * $W_{CART} = 1.14 \times W$
 * P = PRESSURE AT GROUND CONNECTION, PSIG
 * TEMP AT GROUND CONNECTION = 200°F (93°C) TO 450°F (232°C)

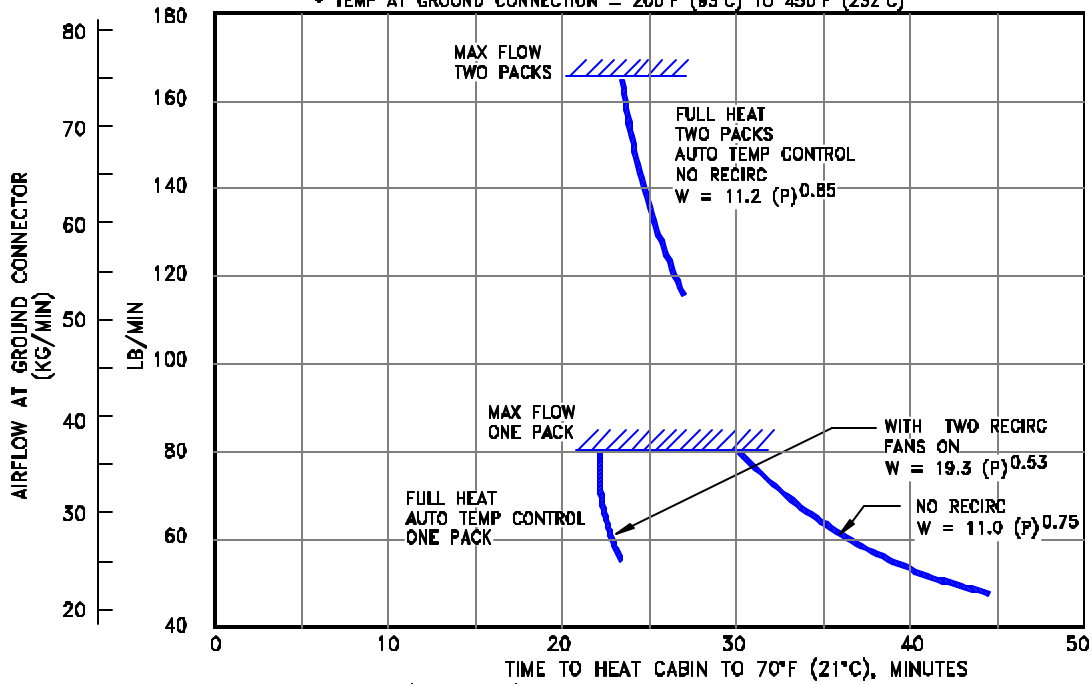

COOLING (PULL-DOWN)
 * INITIAL CABIN TEMPERATURE: 103°F (39.5°C)
 * OUTSIDE AIR TEMPERATURE: 103°F (39.5°C)
 * SOLAR LOAD: 7,741 BTU/HR (1,951 KCAL/HR)
 * NO GALLEY LOAD, NO ELECTRICAL LOAD
 * TEMPERATURE AT GROUND CONNECTION LESS THAN 450°F (232°C)
 * $W_{CART} = 1.17 \times W$
 * P = PRESSURE AT GROUND CONNECTION, PSIG

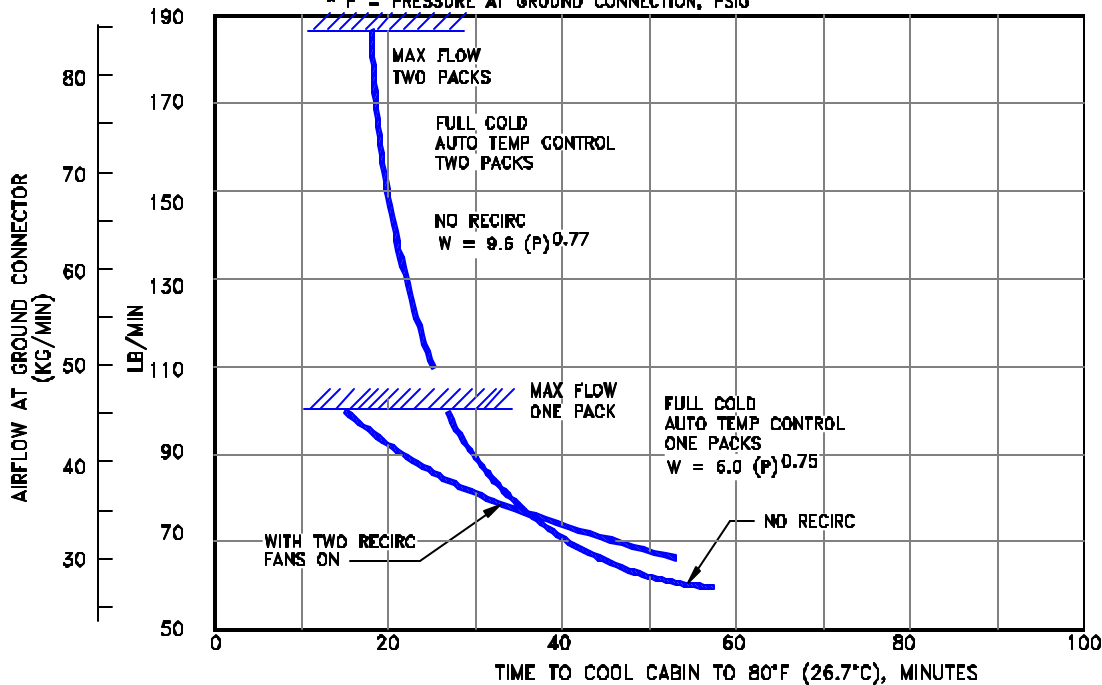

5.6.3 GROUND PNEUMATIC POWER REQUIREMENTS - HEATING/COOLING MODEL 737-400

HEATING (PULL-UP)

- INITIAL CABIN TEMPERATURE - 0°F (-18°C)
- NO GALLEY LOAD
- NO ELECTRICAL LOAD
- $W_{CART} = 1.23 \times W$
- P = PRESSURE AT GROUND CONNECTION
- TEMP AT GROUND CONNECTION 200°F (66°C) TO 450°F (323°C)

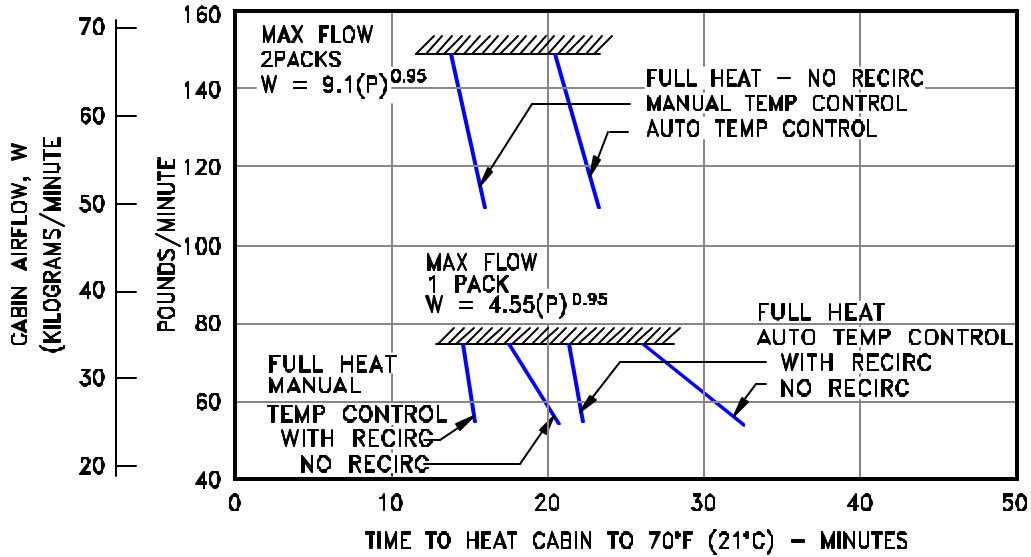

COOLING (PULLDOWN)

- INITIAL CABIN TEMPERATURE - 103°F (39°C)
- OUTSIDE AIR TEMPERATURE - 103°F (39°C)
- SOLAR LOAD - 4,800 BTU/HR (1,210 KCAL/HR)
- NO GALLEY LOAD
- TEMP AT GROUND CONNECTION - LESS THAN 450°F (232°C)
- $W_{CART} = 1.26 \times W$
- P = PRESSURE AT GROUND CONNECTION, PSIG
- NO ELECTRICAL LOAD
- RH = RELATIVE HUMIDITY

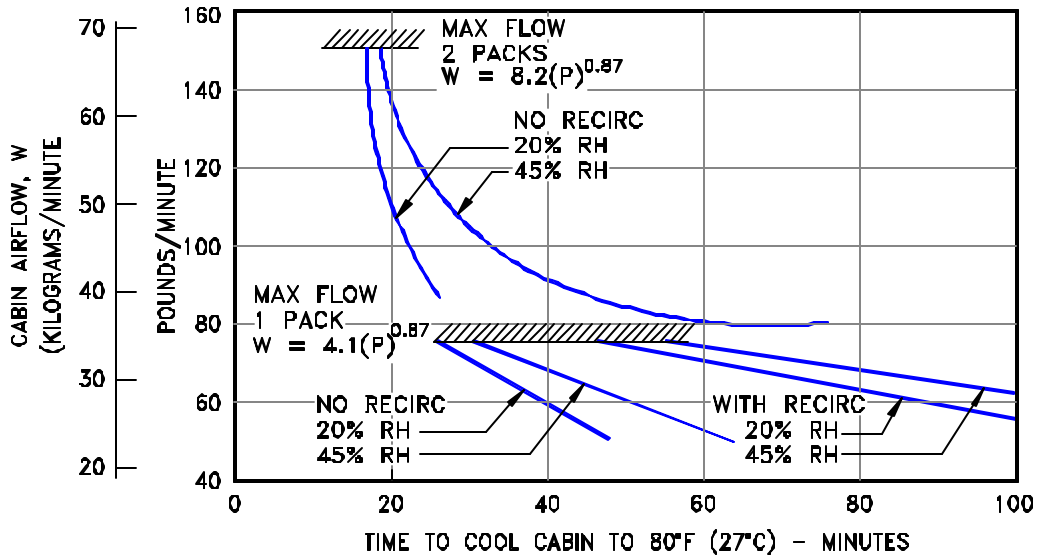

5.6.4 GROUND PNEUMATIC POWER REQUIREMENTS - HEATING/COOLING

MODEL 737-600, -700

HEATING (PULL-UP)

- INITIAL CABIN TEMPERATURE - 0°F (-18°C)
- OUTSIDE AIR TEMPERATURE - 0°F (-18°C)
- NO GALLEY LOAD, NO ELECTRICAL LOAD
- $W_{CART} = 1.14 \times W$
- P = PRESSURE AT GROUND CONNECTION
- TEMP AT GROUND CONNECTION - 200°F (65°C) TO 450°F (232°C)

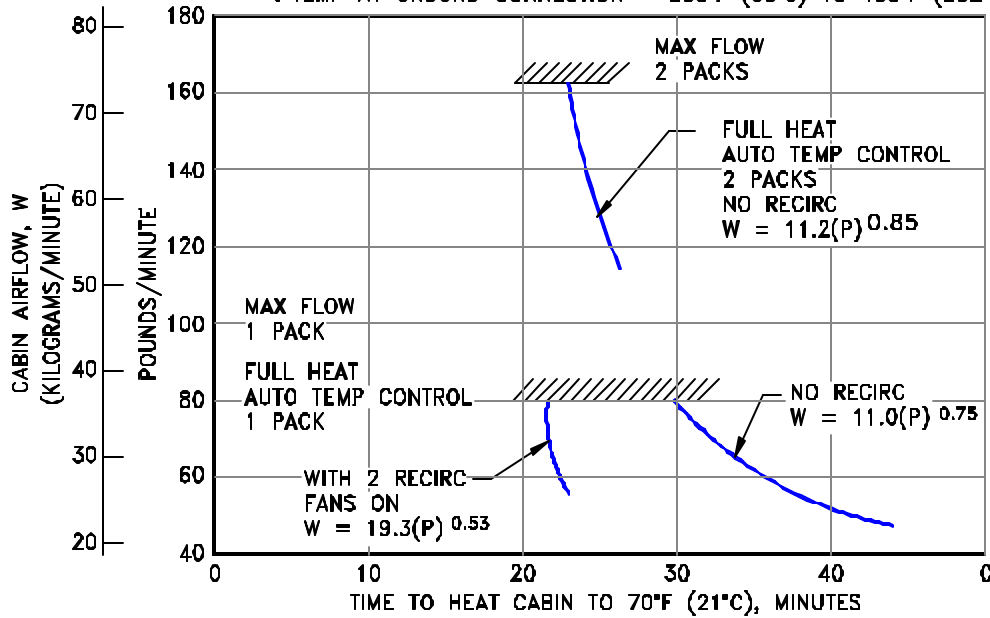

COOLING (PULL-DOWN)

- INITIAL CABIN TEMPERATURE - 103°F (39°C)
- OUTSIDE AIR TEMPERATURE - 103°F (39°C)
- SOLAR LOAD - 7,741 BTU/HR (1,951 KCAL/HR)
- NO GALLEY LOAD, NO ELECTRICAL LOAD
- $W_{CART} = 11.7 \times W$
- P = PRESSURE AT GROUND CONNECTION, PSIG
- TEMP AT GROUND CONNECTION - LESS THAN 450°F (232°C)

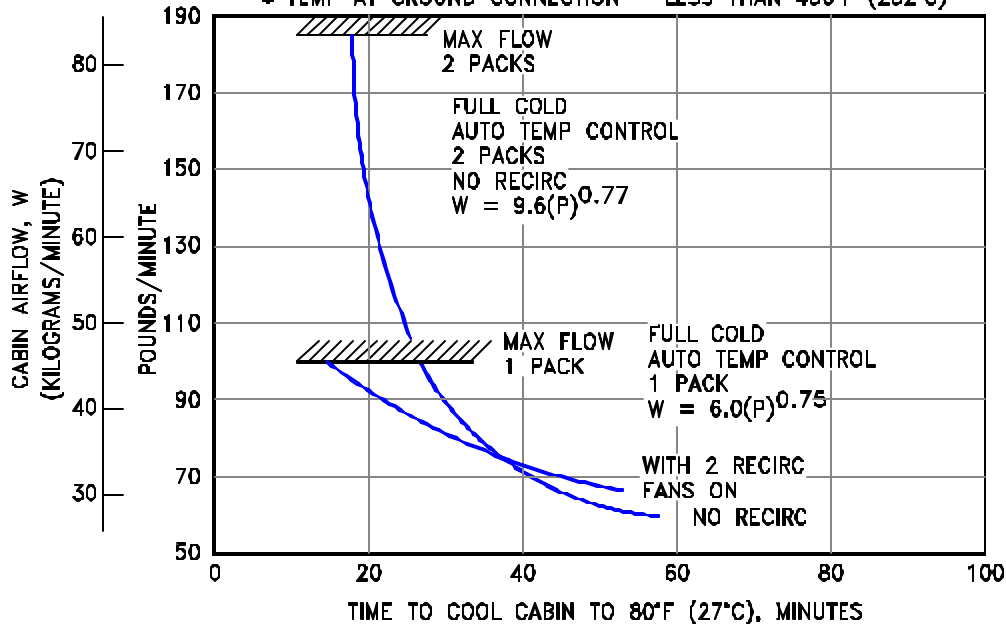

5.6.5 GROUND PNEUMATIC POWER REQUIREMENTS - HEATING/COOLING

MODEL 737-800, -900

COOLING:

- ① CABIN AT 75° F (24° C); 90 PASSENGERS AND CREW; NO GALLEY LOAD; SOLAR LOAD 5,570 BTU/HR; ELECTRICAL LOAD 6,340 BTU/HR.
- ② CABIN AT 80° F (27° C); OTHERWISE SAME AS IN ①.
- ③ CABIN AT 70° F (21° C); 3 CREW MEMBERS; GALLEY LOAD 8,200 BTU/HR; SOLAR LOAD 5,570 BTU/HR; ELECTRICAL LOAD 6,340 BTU/HR.
- ④ CABIN AT 80° F (27° C); 65 PASSENGERS AND CREW; NO GALLEY LOAD; SOLAR LOAD 5,570 BTU/HR; ELECTRICAL LOAD 6,340 BTU/HR. PRECONDITIONED AIRPLANE.

HEATING:

- ⑤ CABIN AT 75° F (24° C); NO CREW OR PASSENGERS; NO OTHER HEAT LOADS.
- ⑥ CABIN AT 75° F (24° C); NO CREW OR PASSENGERS; NO OTHER HEAT LOADS.
- ⑦ CABIN AT 75° F (24° C); NO CREW OR PASSENGERS; NO OTHER HEAT LOADS.
- ⑧ CABIN AT 75° F (24° C); 65 PASSENGERS AND CREW; NO GALLEY LOAD; NO SOLAR LOAD; ELECTRICAL LOAD 6,430 BTU/HR; PRECONDITIONED AIRPLANE.

ΔP_s = GAGE STATIC PRESSURE IN INCHES OF WATER AT GROUND CONNECTION.

1 BTU/HR = 0.252 KG-CAL/HR

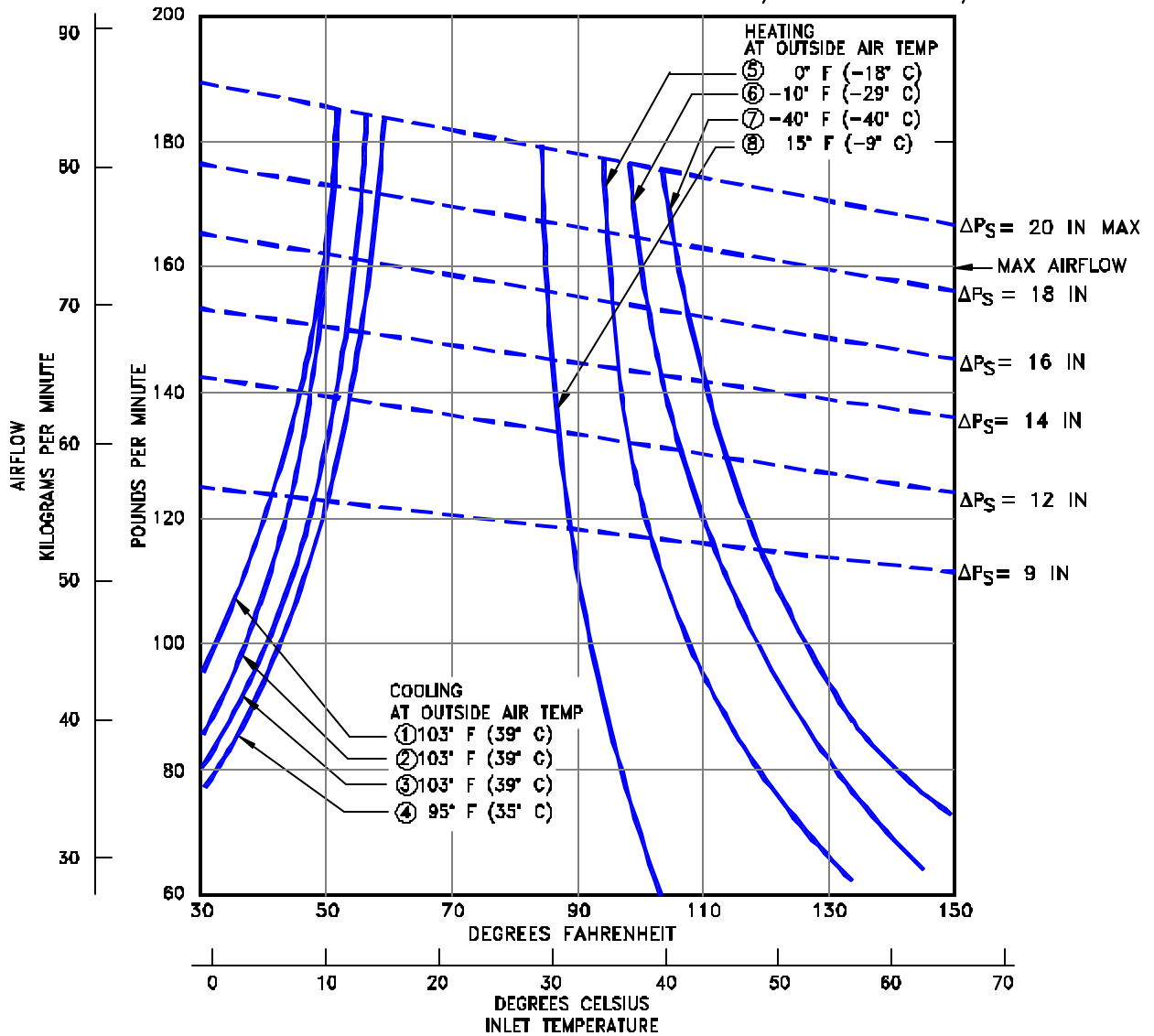

NOTES:

- * AIRFLOW REQUIREMENTS ARE SHOWN FOR THE 737-200 AIRPLANE AND ARE APPROXIMATELY 5 TO 10 LB/MIN GREATER THAN FOR THE 737-100, DEPENDING ON CONDITIONS AND LOADING
- * MAXIMUM RECOMMENDED AIRFLOW = 160 LB/MIN (72 KG/MIN TO AVOID OPENING OF THE DISTRIBUTION RELIEF VALVE)

5.7.1 CONDITIONED AIR FLOW REQUIREMENTS

MODEL 737-100, -200

COOLING:

- ① CABIN AT 75° F (24° C); 138 PASSENGERS AND CREW; NO GALLEY LOAD; SOLAR LOAD 4,800 BTU/HR; ELECTRICAL LOAD 6,984 BTU/HR.
- ② CABIN AT 80° F (27° C); OTHERWISE SAME AS IN ①.
- ③ CABIN AT 70° F (21° C); 2 CREW MEMBERS; GALLEY LOAD 8,200 BTU/HR; SOLAR LOAD 4,800 BTU/HR; ELECTRICAL LOAD 6,984 BTU/HR.
- ④ CABIN AT 80° F (27° C); 98 PASSENGERS AND CREW; NO GALLEY LOAD; SOLAR LOAD 4,800 BTU/HR; ELECTRICAL LOAD 6,984 BTU/HR. PRECONDITIONED AIRPLANE.

HEATING:

- ⑤ CABIN AT 75° F (24° C); NO CREW OR PASSENGERS; NO OTHER HEAT LOADS.
- ⑥ CABIN AT 75° F (24° C); NO CREW OR PASSENGERS; NO OTHER HEAT LOADS.
- ⑦ CABIN AT 75° F (24° C); NO CREW OR PASSENGERS; NO OTHER HEAT LOADS.
- ⑧ CABIN AT 75° F (24° C); 98 PASSENGERS AND CREW; NO GALLEY LOAD; NO SOLAR LOAD; ELECTRICAL LOAD 6,984 BTU/HR; PRECONDITIONED AIRPLANE.

ΔP_s = GAGE STATIC PRESSURE IN INCHES OF WATER AT GROUND CONNECTION.
 1 BTU/HR = 0.252 KG-CAL/HR

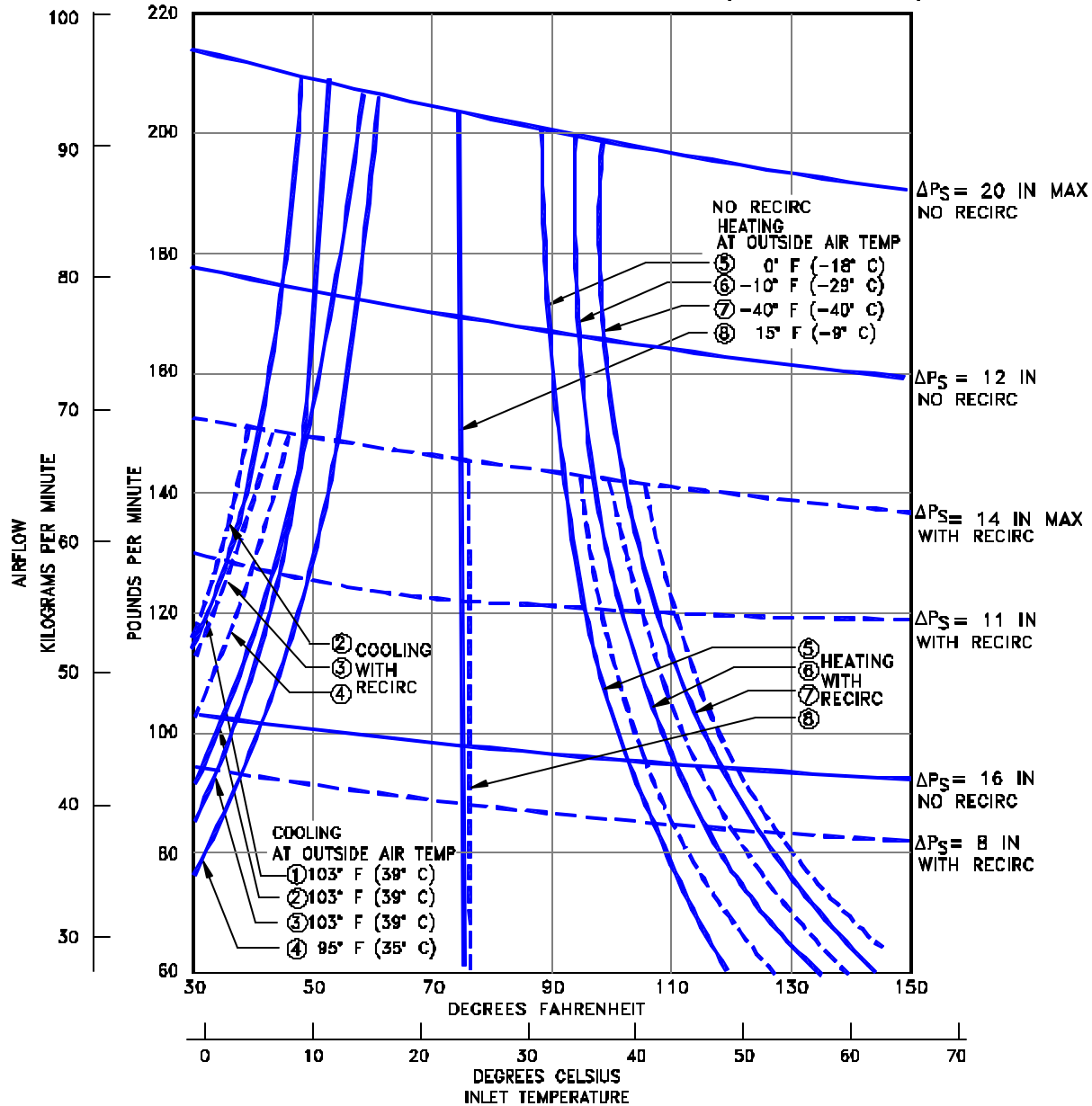

5.7.2 CONDITIONED AIR FLOW REQUIREMENTS
 MODEL 737-300, -500

COOLING:

- ① CABIN AT 75° F (24° C); 165 PASSENGERS AND CREW; NO GALLEY LOAD; SOLAR LOAD 7,741 BTU/HR; ELECTRICAL LOAD 10,955 BTU/HR.
- ② CABIN AT 80° F (27° C); OTHERWISE SAME AS IN ①.
- ③ CABIN AT 70° F (21° C); 2 CREW MEMBERS; GALLEY LOAD 8,200 BTU/HR; SOLAR LOAD 7,741 BTU/HR; ELECTRICAL LOAD 10,955 BTU/HR.
- ④ CABIN AT 80° F (27° C); 117 PASSENGERS AND CREW; NO GALLEY LOAD; SOLAR LOAD 7,741 BTU/HR; ELECTRICAL LOAD 10,955 BTU/HR. PRECONDITIONED AIRPLANE.

HEATING:

- ⑤ CABIN AT 75° F (24° C); NO CREW OR PASSENGERS; NO OTHER HEAT LOADS.
- ⑥ CABIN AT 75° F (24° C); NO CREW OR PASSENGERS; NO OTHER HEAT LOADS.
- ⑦ CABIN AT 75° F (24° C); NO CREW OR PASSENGERS; NO OTHER HEAT LOADS.
- ⑧ CABIN AT 75° F (24° C); 117 PASSENGERS AND CREW; NO GALLEY LOAD; NO SOLAR LOAD; ELECTRICAL LOAD 10,955 BTU/HR; PRECONDITIONED AIRPLANE.

ΔP_s = GAGE STATIC PRESSURE IN INCHES OF WATER AT GROUND CONNECTION.

1 BTU/HR = 0.252 KG-CAL/HR

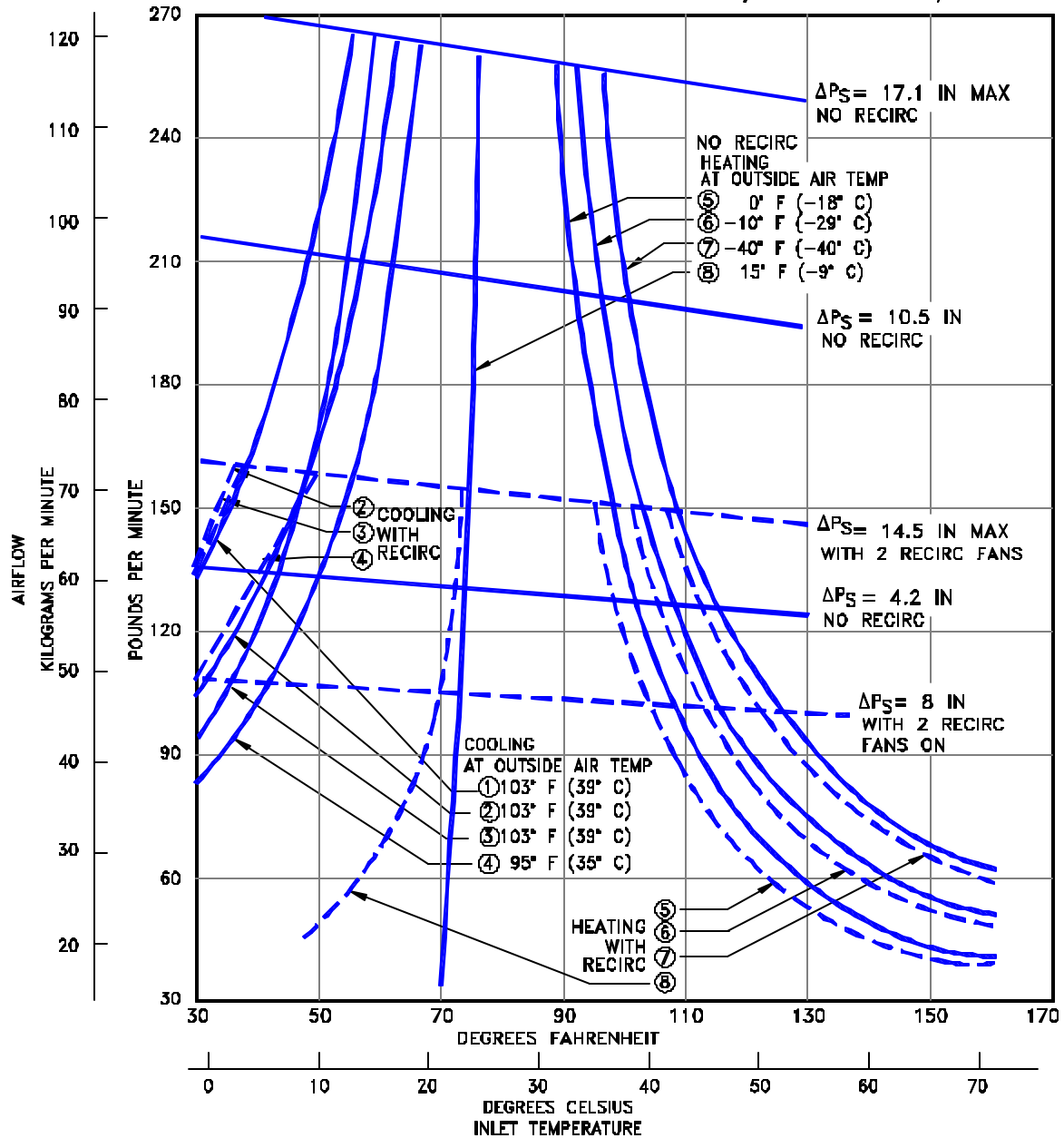

5.7.3 CONDITIONED AIR FLOW REQUIREMENTS

MODEL 737-400

COOLING:

- ① CABIN AT 75° F (24° C); 138 PASSENGERS AND CREW; NO GALLEY LOAD; SOLAR LOAD 4,800 BTU/HR; ELECTRICAL LOAD 6,984 BTU/HR.
- ② CABIN AT 80° F (27° C); OTHERWISE SAME AS IN ①.
- ③ CABIN AT 70° F (21° C); 2 CREW MEMBERS; GALLEY LOAD 8,200 BTU/HR; SOLAR LOAD 4,800 BTU/HR; ELECTRICAL LOAD 6,984 BTU/HR.
- ④ CABIN AT 80° F (27° C); 98 PASSENGERS AND CREW; NO GALLEY LOAD; SOLAR LOAD 4,800 BTU/HR; ELECTRICAL LOAD 6,984 BTU/HR. PRECONDITIONED AIRPLANE.

HEATING:

- ⑤ CABIN AT 75° F (24° C); NO CREW OR PASSENGERS; NO OTHER HEAT LOADS.
 - ⑥ CABIN AT 75° F (24° C); NO CREW OR PASSENGERS; NO OTHER HEAT LOADS.
 - ⑦ CABIN AT 75° F (24° C); NO CREW OR PASSENGERS; NO OTHER HEAT LOADS.
 - ⑧ CABIN AT 75° F (24° C); 98 PASSENGERS AND CREW; NO GALLEY LOAD; NO SOLAR LOAD; ELECTRICAL LOAD 6,984 BTU/HR; PRECONDITIONED AIRPLANE.
- ΔP_s = GAGE STATIC PRESSURE IN INCHES OF WATER AT GROUND CONNECTION.

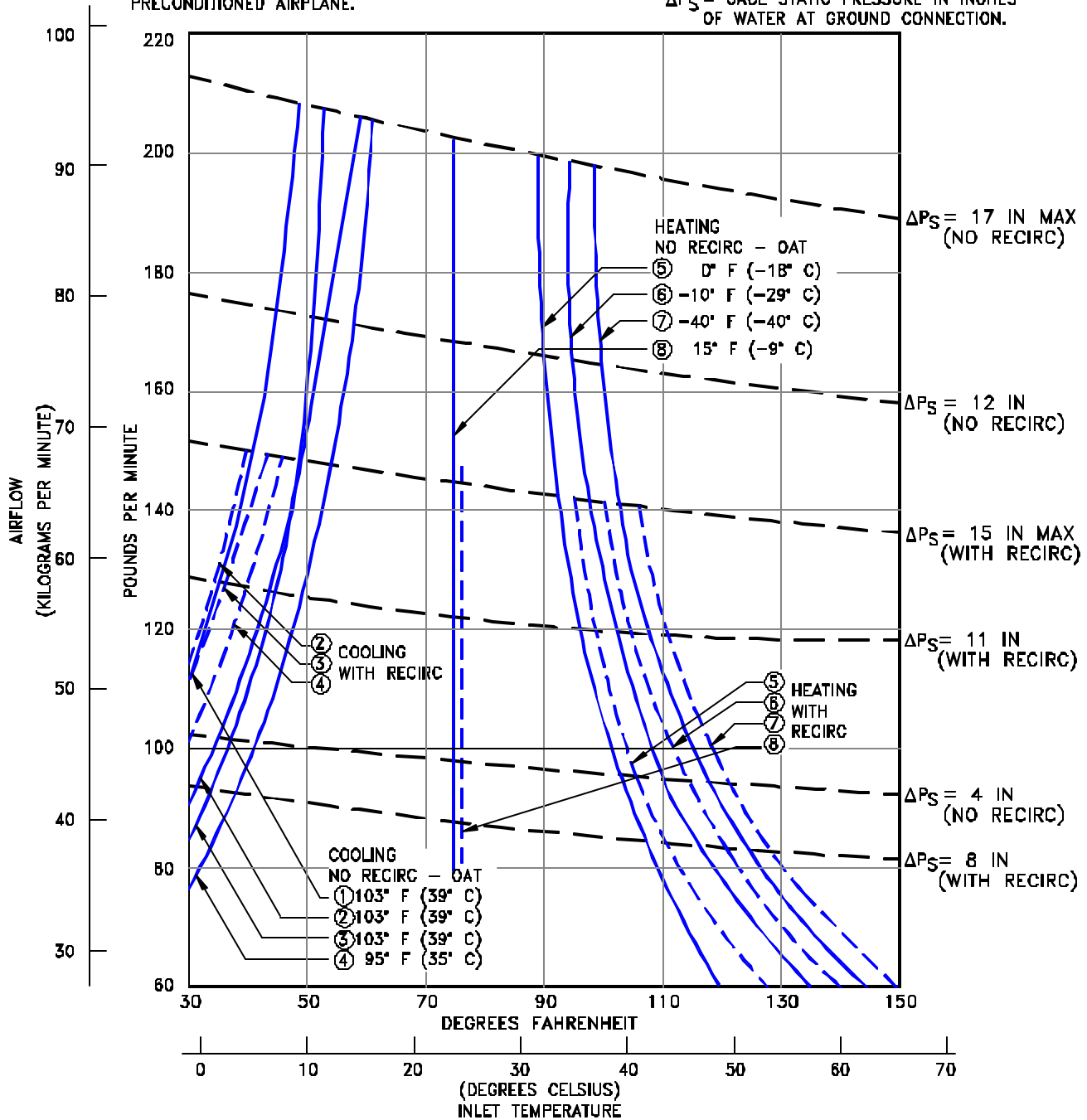

5.7.4 CONDITIONED AIR FLOW REQUIREMENTS

MODEL 737-600, -700

COOLING:

- ① CABIN AT 75° F (24° C); 185 PASSENGERS AND CREW; NO GALLEY LOAD; SOLAR LOAD 7,741 BTU/HR; ELECTRICAL LOAD 10,955 BTU/HR.
- ② CABIN AT 80° F (27° C); OTHERWISE SAME AS IN ①
- ③ CABIN AT 70° F (21° C); 2 CREW MEMBERS; GALLEY LOAD 8,200 BTU/HR; SOLAR LOAD 7,741 BTU/HR; ELECTRICAL LOAD 10,955 BTU/HR.
- ④ CABIN AT 80° F (27° C); 117 PASSENGERS AND CREW; NO GALLEY LOAD; SOLAR LOAD 7,741 BTU/HR; ELECTRICAL LOAD 10,955 BTU/HR; PRECONDITIONED AIRPLANE.

HEATING:

- ⑤ CABIN AT 75° F (24° C); NO CREW OR PASSENGERS; NO OTHER HEAT LOADS.
- ⑥ CABIN AT 75° F (24° C); NO CREW OR PASSENGERS; NO OTHER HEAT LOADS.
- ⑦ CABIN AT 75° F (24° C); NO CREW OR PASSENGERS; NO OTHER HEAT LOADS.
- ⑧ CABIN AT 75° F (24° C); 117 PASSENGERS AND CREW; NO GALLEY LOAD; NO SOLAR LOAD; ELECTRICAL LOAD 10,955 BTU/HR; PRECONDITIONED AIRPLANE.

ΔP_s = GAGE STATIC PRESSURE IN INCHES OF WATER AT GROUND CONNECTION.

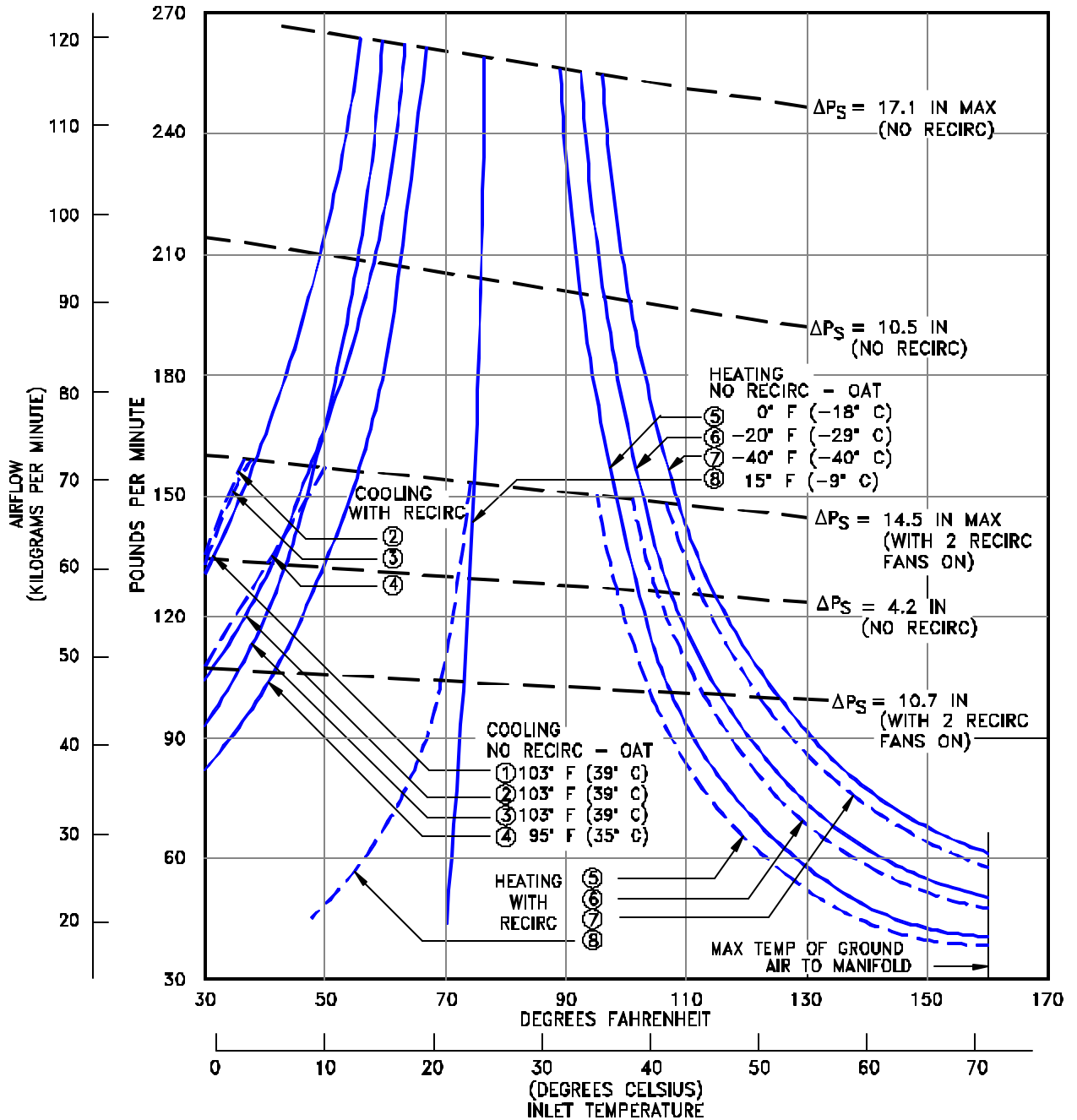

5.7.5 CONDITIONED AIR FLOW REQUIREMENTS
MODEL 737-800, -900

NOTES:

- UNUSUAL BREAKAWAY CONDITIONS NOT REFLECTED
- ESTIMATED FOR RUBBER-TIRED TOW VEHICLES
- COEFFICIENT OF FRICTION (μ) APPROXIMATE

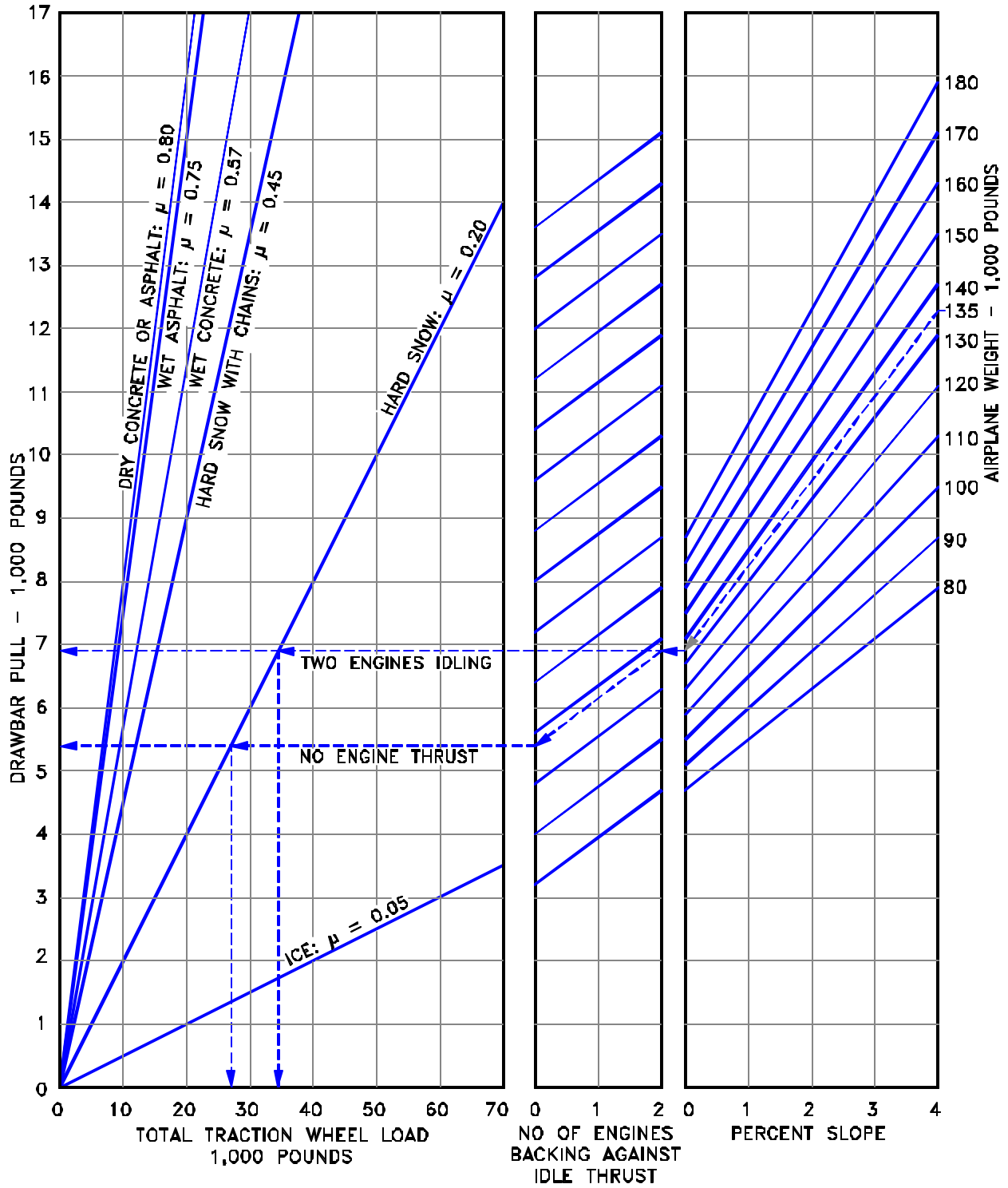

5.8.1 GROUND TOWING REQUIREMENTS - ENGLISH UNITS
 MODEL 737, ALL MODELS

NOTES:

- UNUSUAL BREAKAWAY CONDITIONS NOT REFLECTED
- ESTIMATED FOR RUBBER-TIRED TOW VEHICLES
- COEFFICIENT OF FRICTION (μ) APPROXIMATE

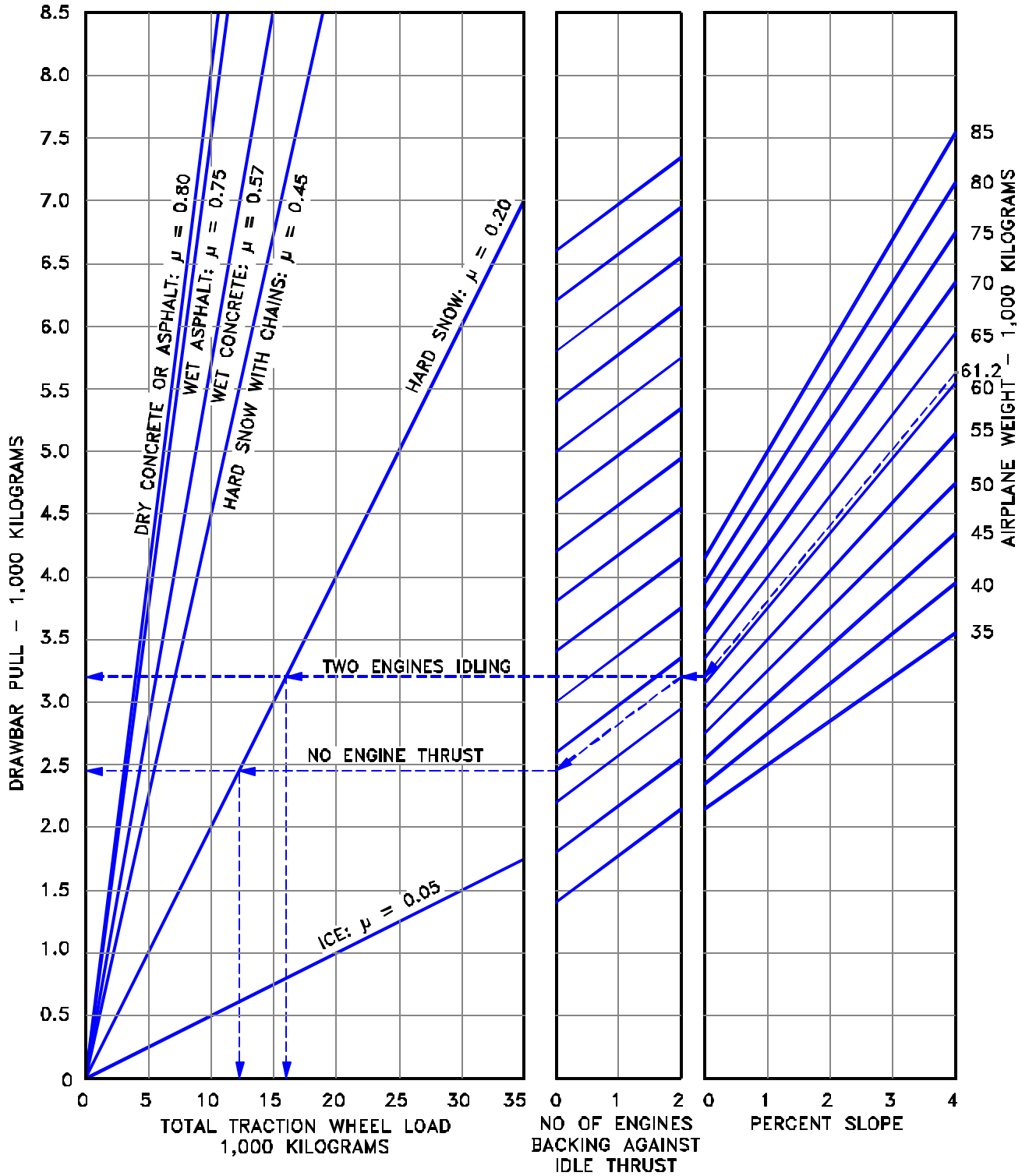

5.8.2 GROUND TOWING REQUIREMENTS - METRIC UNITS
MODEL 737, ALL MODELS

THIS PAGE INTENTIONALLY LEFT BLANK

6.0 JET ENGINE WAKE AND NOISE DATA

6.1 Jet Engine Exhaust Velocities and Temperatures

6.2 Airport and Community Noise

6.0 JET ENGINE WAKE AND NOISE DATA

6.1 Jet Engine Exhaust Velocities and Temperatures

This section shows exhaust velocity and temperature contours aft of the 737 airplanes. The contours were calculated from a standard computer analysis using three-dimensional viscous flow equations with mixing of primary, fan, and free-stream flow. The presence of the ground plane is included in the calculations as well as engine tilt and toe-in. Mixing of flows from the engines is also calculated. The analysis does not include thermal buoyancy effects which tend to elevate the jet wake above the ground plane. The buoyancy effects are considered to be small relative to the exhaust velocity and therefore are not included.

The graphs show jet wake velocity and temperature contours are valid for sea level, static, standard day conditions. The effect of wind on jet wakes was not included. There is evidence to show that a downwind or an upwind component does not simply add or subtract from the jet wake velocity, but rather carries the whole envelope in the direction of the wind. Crosswinds may carry the jet wake contour far to the side at large distances behind the airplane.

- NOTES:
- STANDARD DAY
 - ZERO WIND
 - JT8D ENGINES
 - SEA LEVEL
 - STATIC AIRPLANE

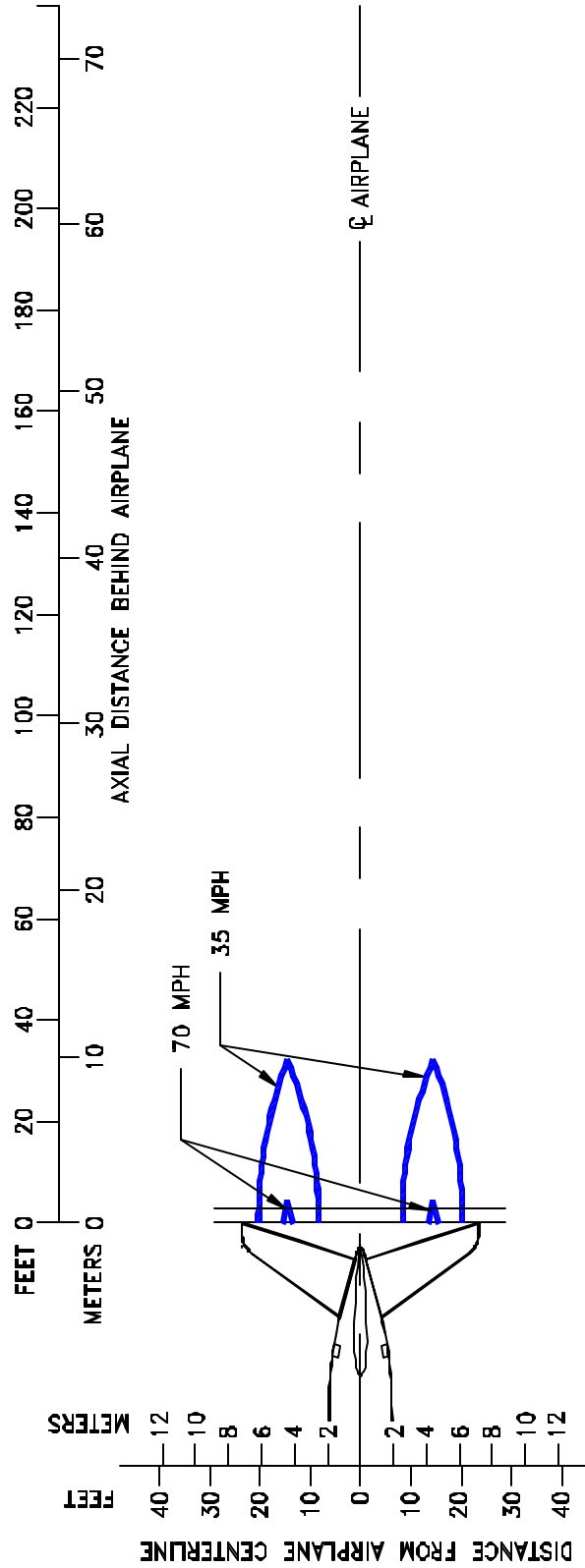
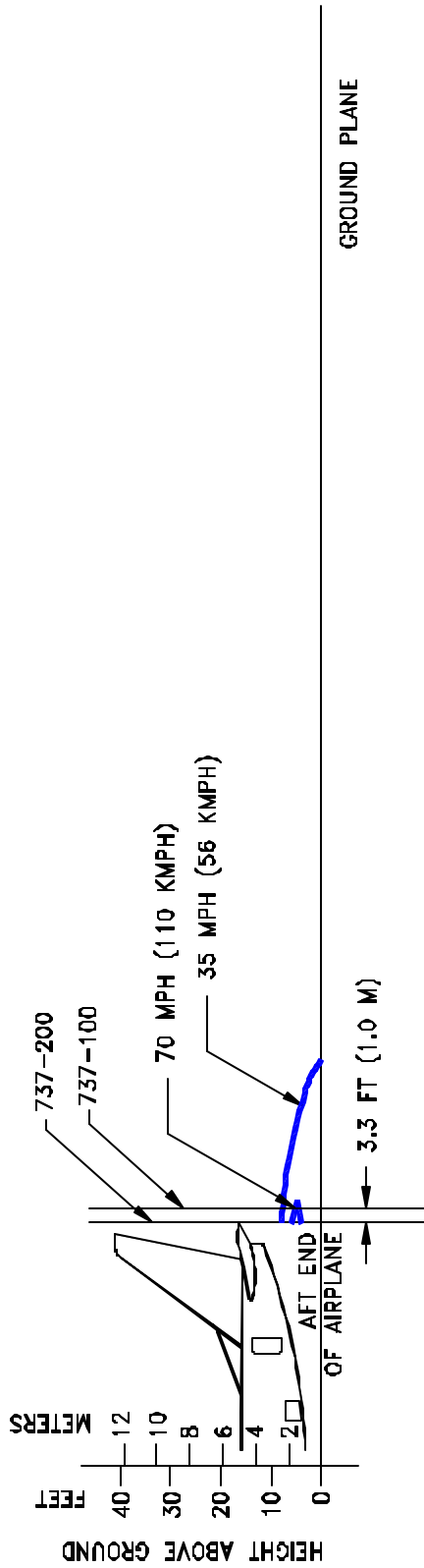

6.1.1 PREDICTED JET ENGINE EXHAUST VELOCITY CONTOURS
 - IDLE THRUST
 MODEL 737-100, -200

- NOTES:
- SEA LEVEL
 - STANDARD DAY
 - ZERO WIND
 - STATIC AIRPLANE

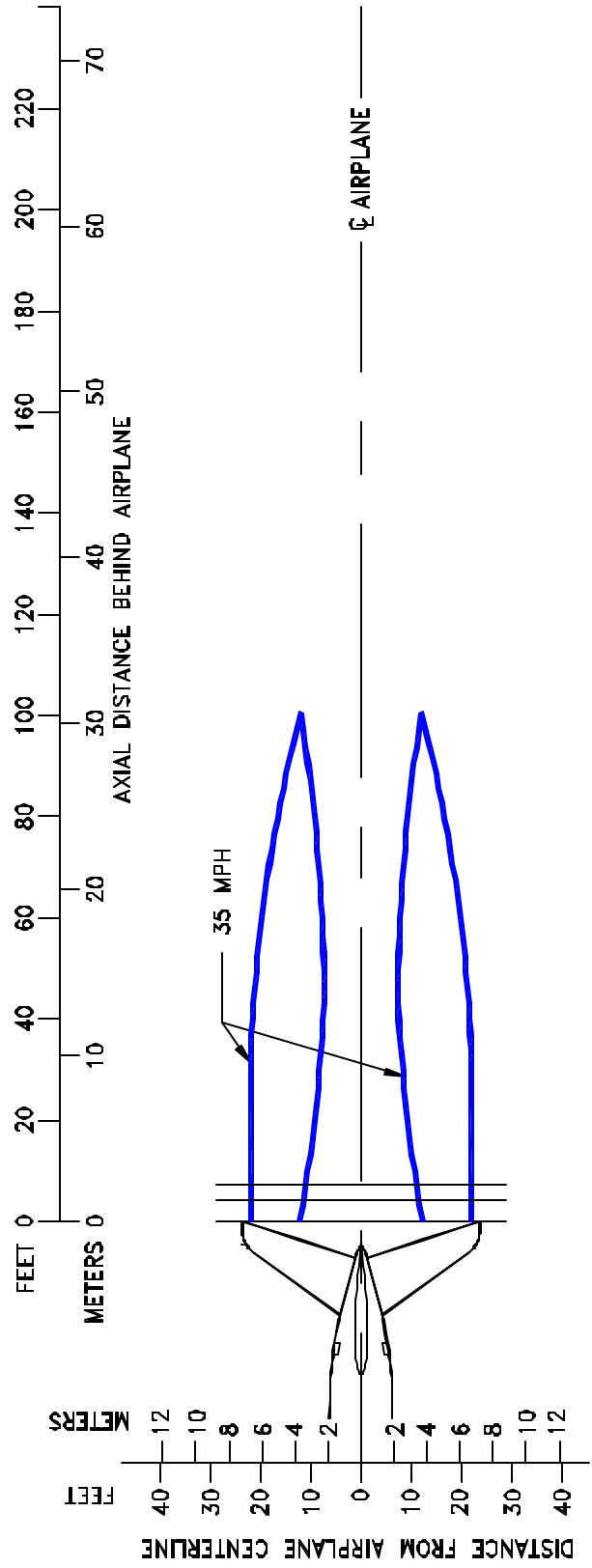
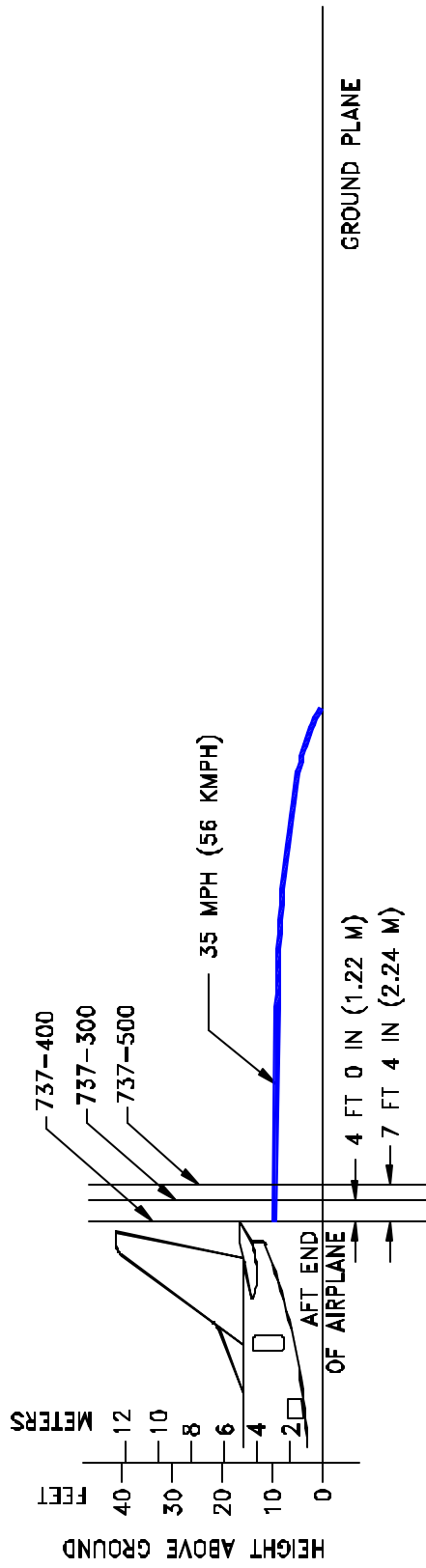

6.1.2 PREDICTED JET ENGINE EXHAUST VELOCITY CONTOURS
 - IDLE THRUST
 MODEL 737-300, -400, -500

- NOTES:
- STANDARD DAY
 - ZERO WIND
 - SEA LEVEL
 - STATIC AIRPLANE

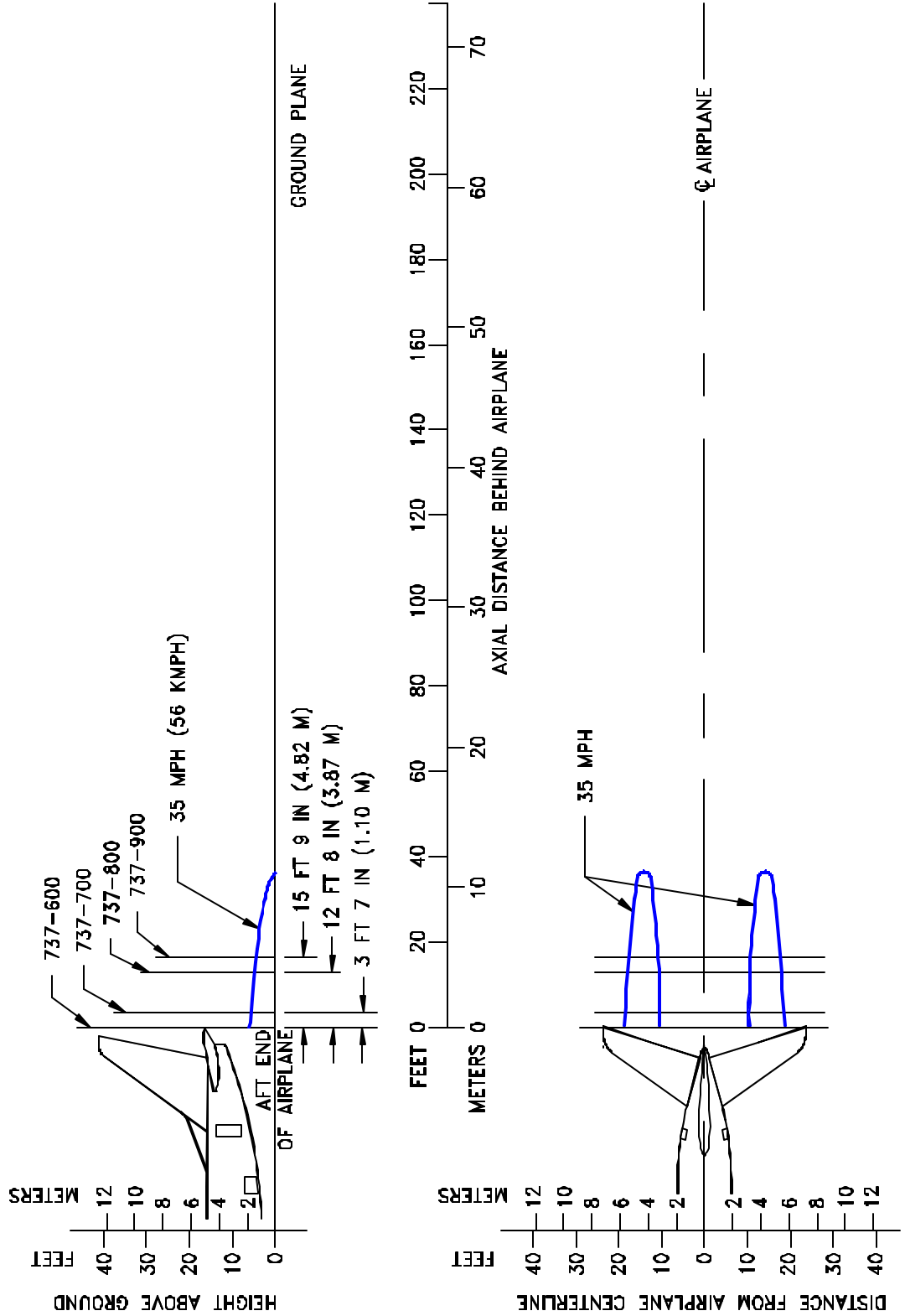

6.1.3 PREDICTED JET ENGINE EXHAUST VELOCITY CONTOURS
 - IDLE THRUST
 MODEL 737-600, -700, -800, -900, ALL MODELS

- NOTES:
- STANDARD DAY
 - ZERO WIND
 - JT8D ENGINES
 - SEA LEVEL
 - STATIC AIRPLANE

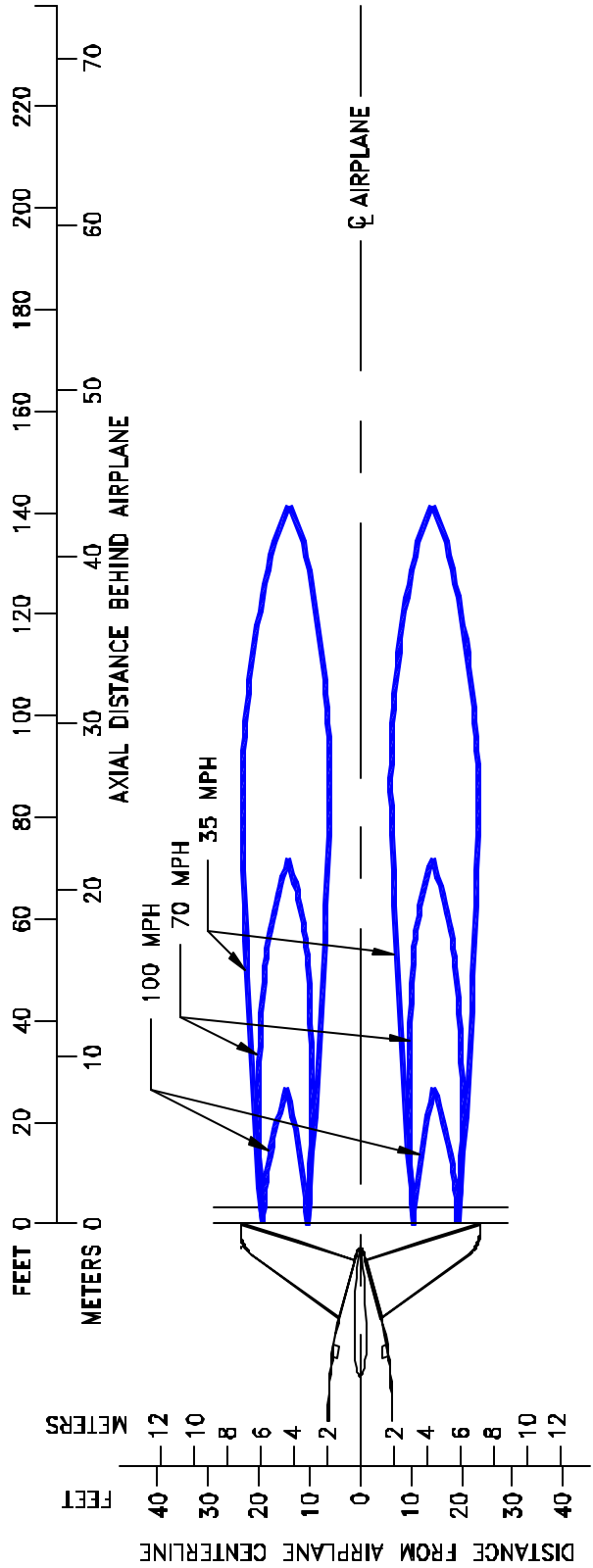
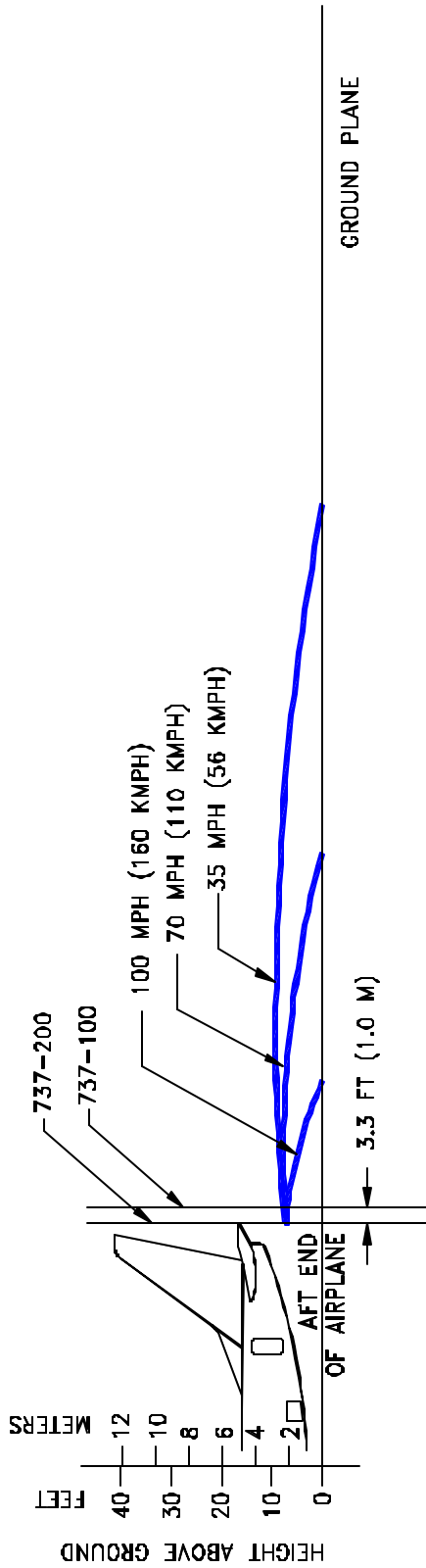

**6.1.4 PREDICTED JET ENGINE EXHAUST VELOCITY CONTOURS
- BREAKAWAY THRUST
MODEL 737-100, -200**

- NOTES:
- STANDARD DAY
 - ZERO WIND
 - SEA LEVEL
 - STATIC AIRPLANE

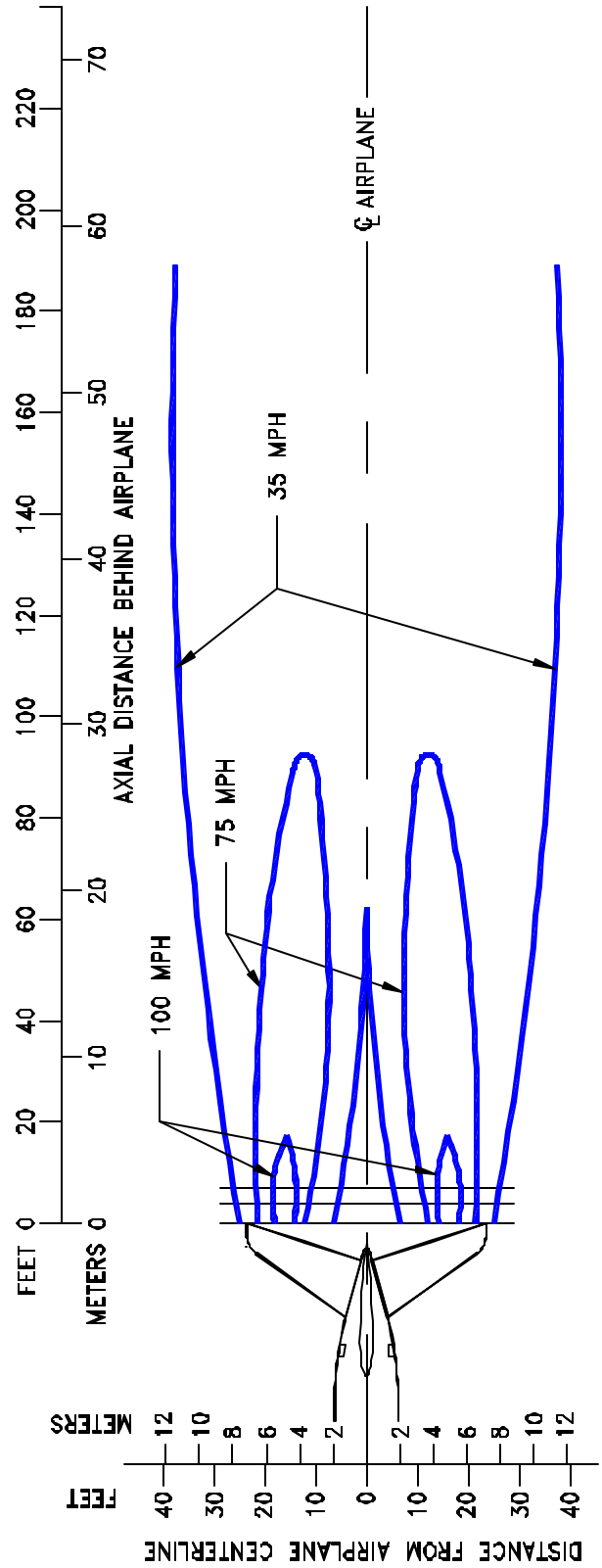
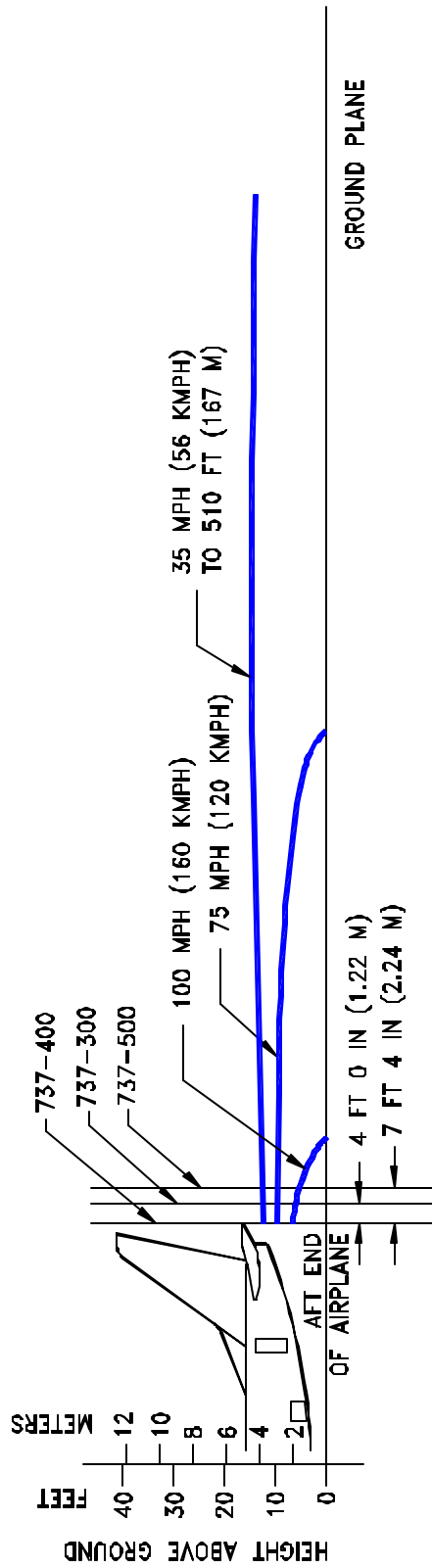

6.1.5 PREDICTED JET ENGINE EXHAUST VELOCITY CONTOURS
- BREAKAWAY THRUST
MODEL 737-300, -400, -500

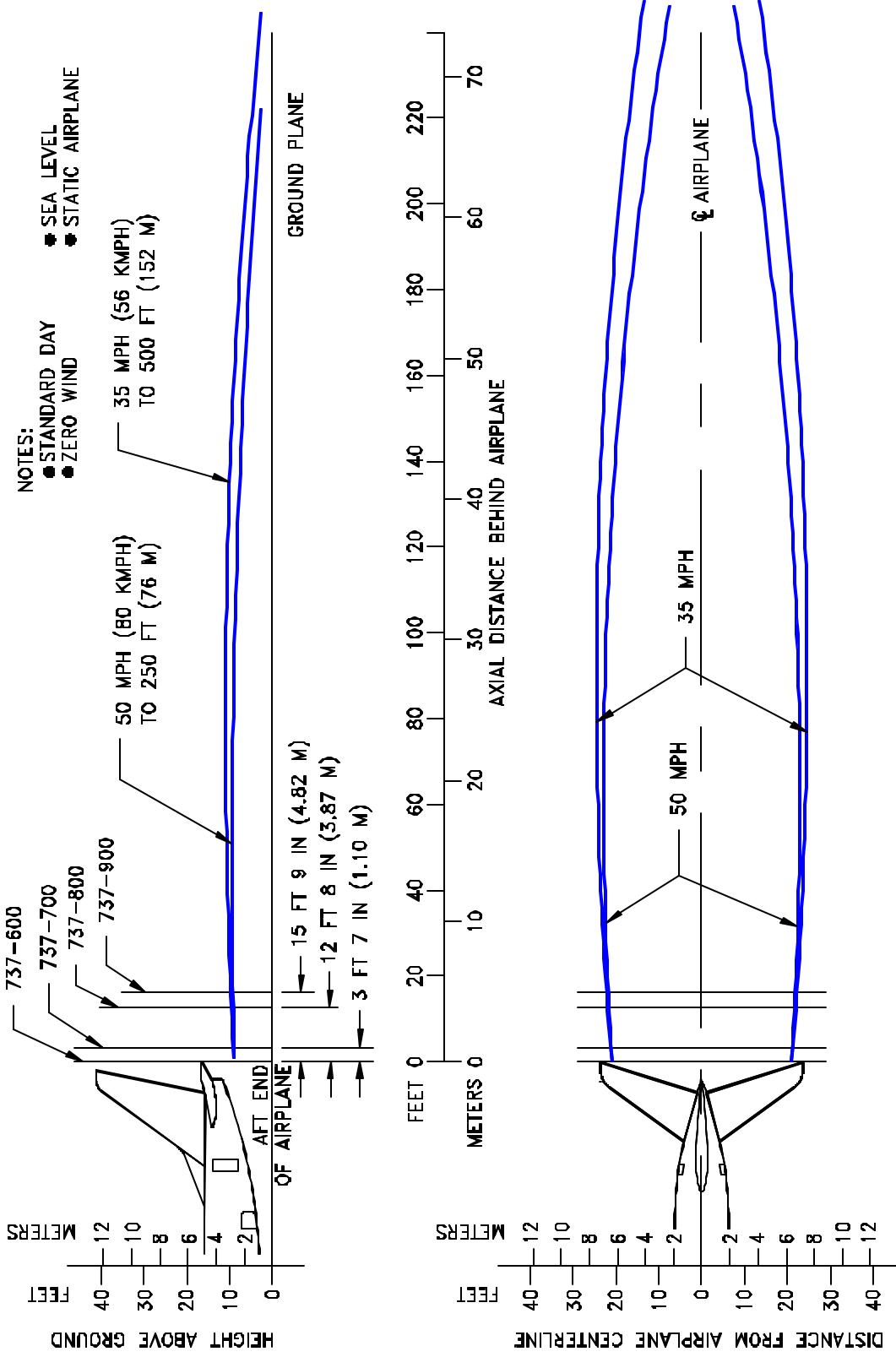

6.1.6 PREDICTED JET ENGINE EXHAUST VELOCITY CONTOURS - BREAKAWAY THRUST
 MODEL 737-600, -700, -800, -900 ALL MODELS

- NOTES:
- STANDARD DAY
 - ZERO WIND
 - SEA LEVEL
 - STATIC AIRPLANE
 - JT8D-17 ENGINES, OTHER JT8D ENGINES EXHIBIT SMALLER VELOCITY CONTOURS

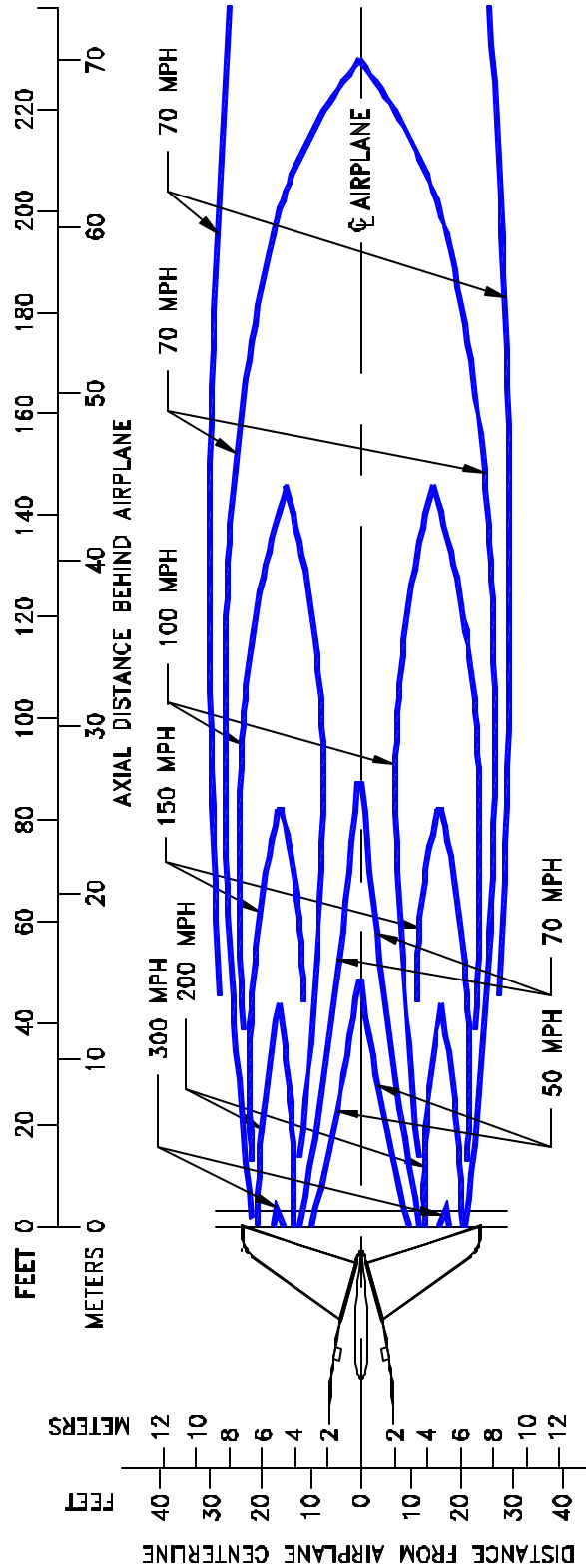
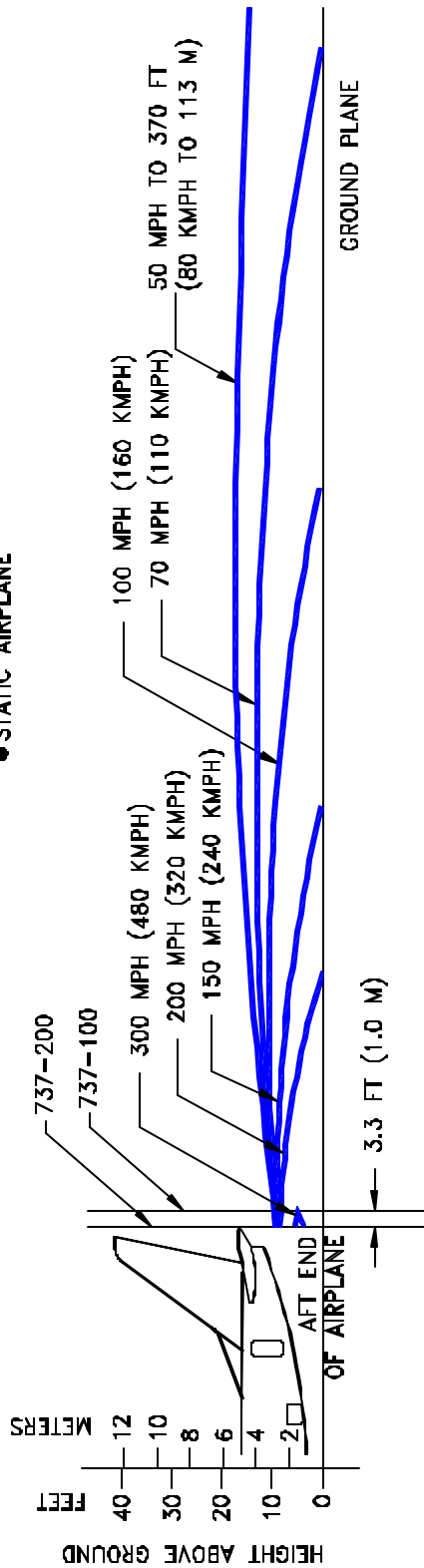

6.1.7 PREDICTED JET ENGINE EXHAUST VELOCITY CONTOURS
 - TAKEOFF THRUST
 MODEL 737-100, -200

- NOTES:
- SEA LEVEL
 - STANDARD DAY
 - ZERO WIND
 - STATIC AIRPLANE

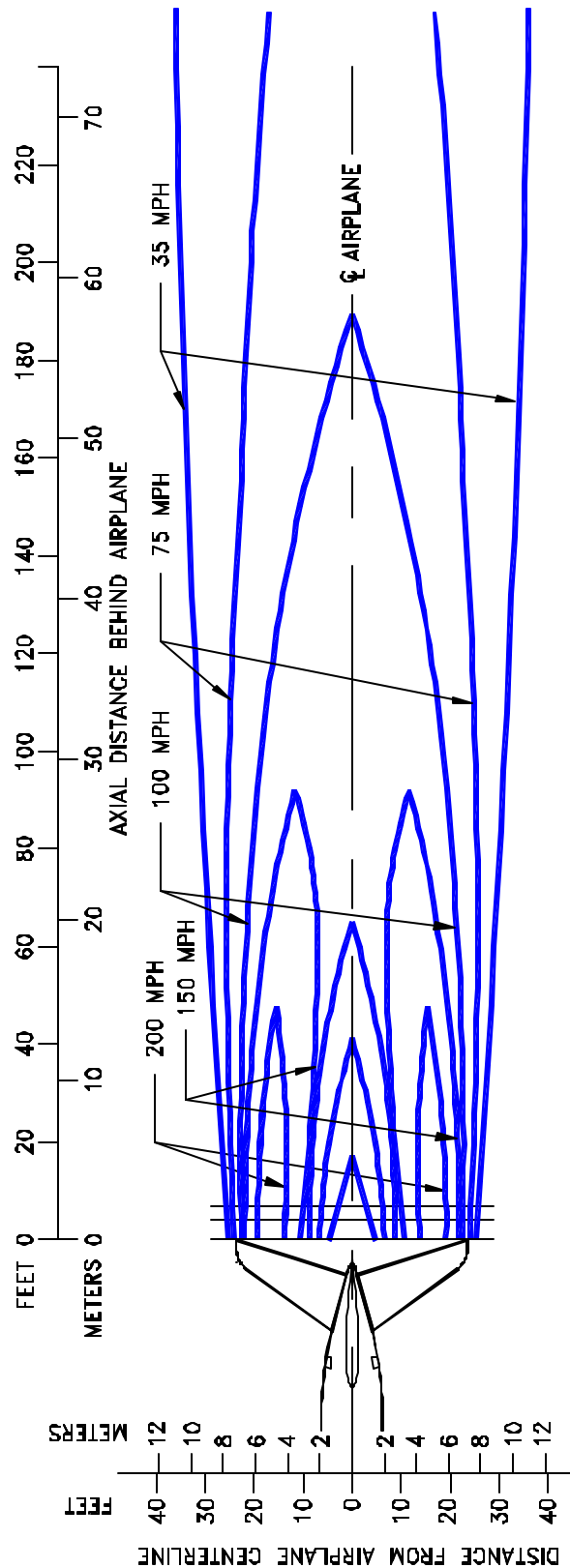
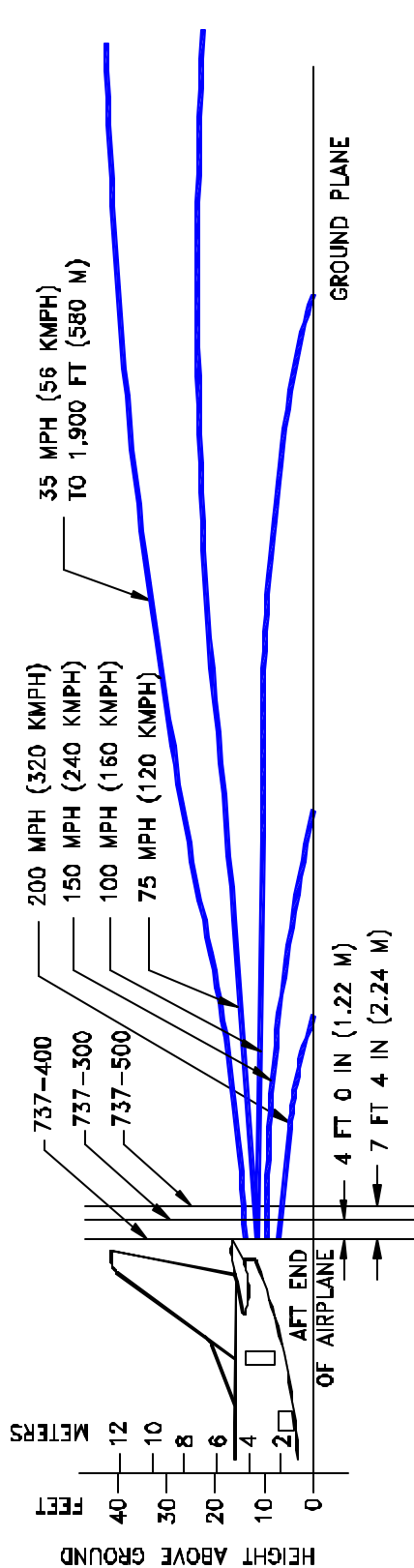

6.1.8 PREDICTED JET ENGINE EXHAUST VELOCITY CONTOURS
 - TAKEOFF THRUST
 MODEL 737-300, -400, -500

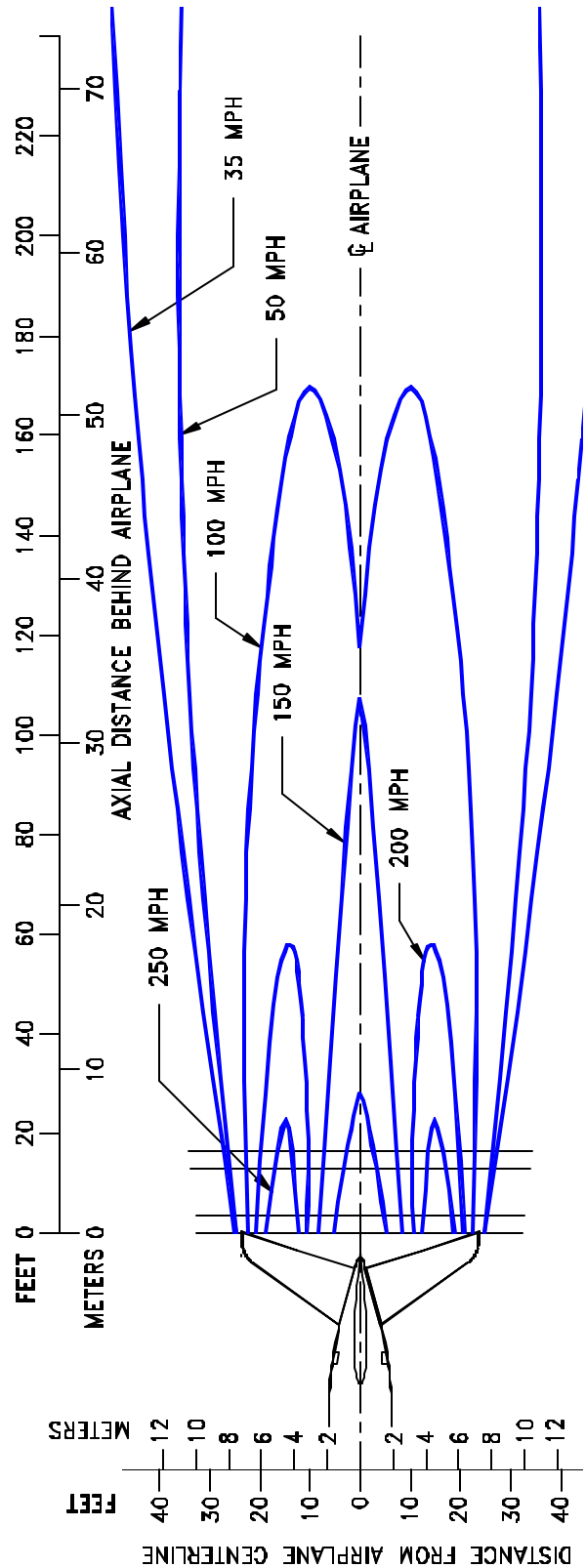
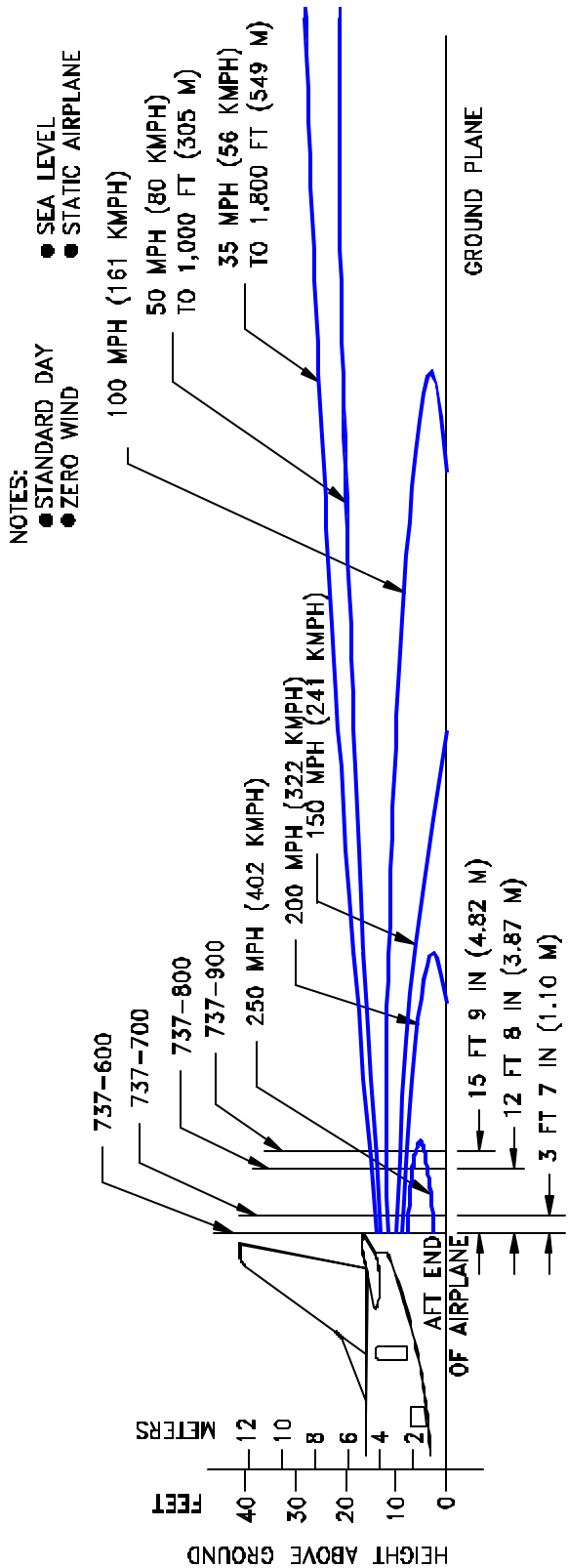

**6.1.9 PREDICTED JET ENGINE EXHAUST VELOCITY CONTOURS
 - TAKEOFF THRUST**

MODEL 737-600, -700, -800, -900 ALL MODELS

- NOTES:
- STANDARD DAY
 - ZERO WIND
 - SEA LEVEL
 - STATIC AIRPLANE
 - JT8D-17 ENGINES

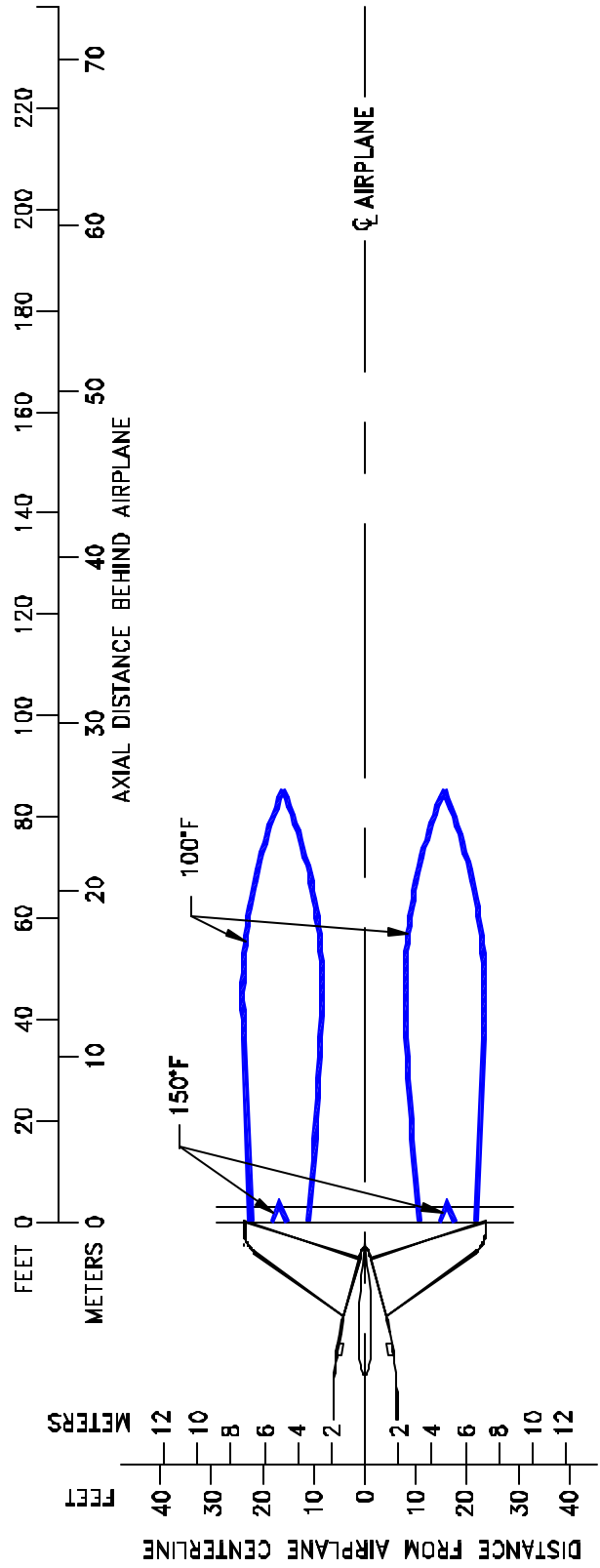
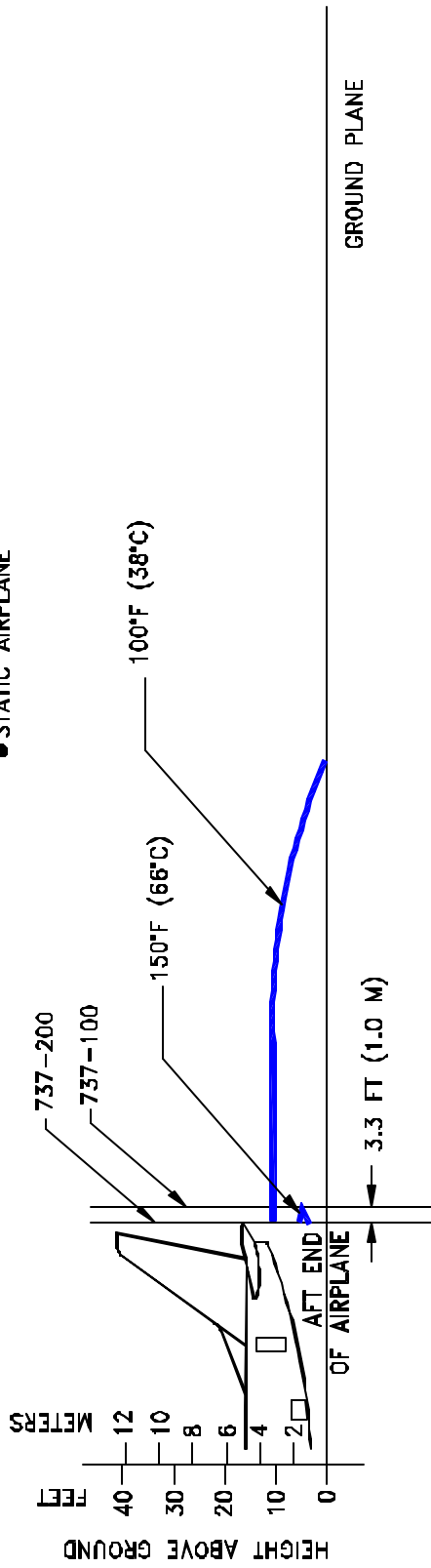

6.1.10 PREDICTED JET ENGINE EXHAUST TEMPERATURE CONTOURS
 - IDLE THRUST
 MODEL 737-100, -200

- NOTES:
- STANDARD DAY
 - ZERO WIND
 - SEA LEVEL
 - STATIC AIRPLANE

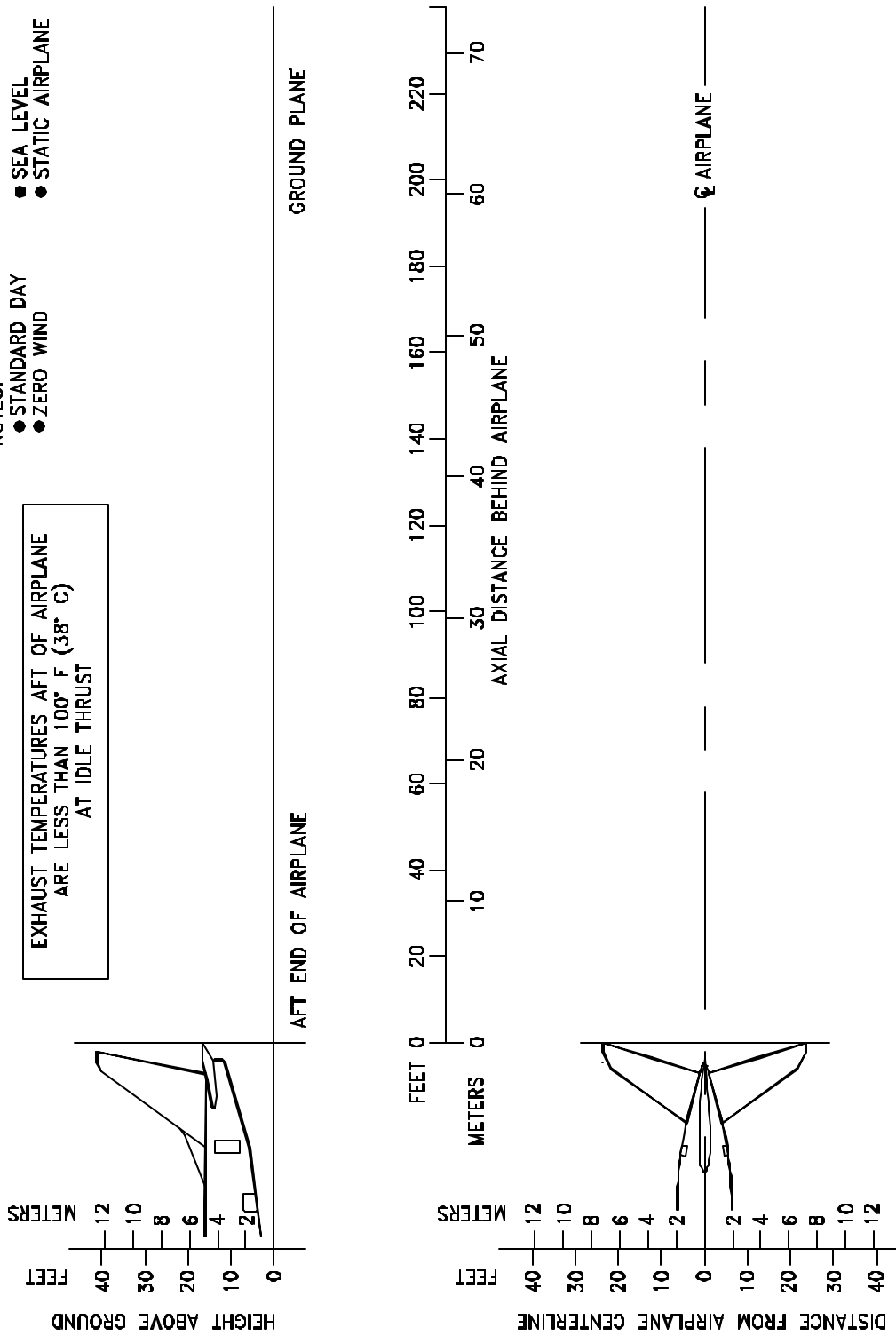

6.1.11 PREDICTED JET ENGINE EXHAUST TEMPERATURE CONTOURS
 - IDLE THRUST
 MODEL 737-300, -400, -500

- NOTES:
- STANDARD DAY
 - ZERO WIND
 - SEA LEVEL
 - STATIC AIRPLANE

EXHAUST TEMPERATURES AFT OF AIRPLANE
ARE LESS THAN 100° F (38° C)
AT BREAKAWAY THRUST

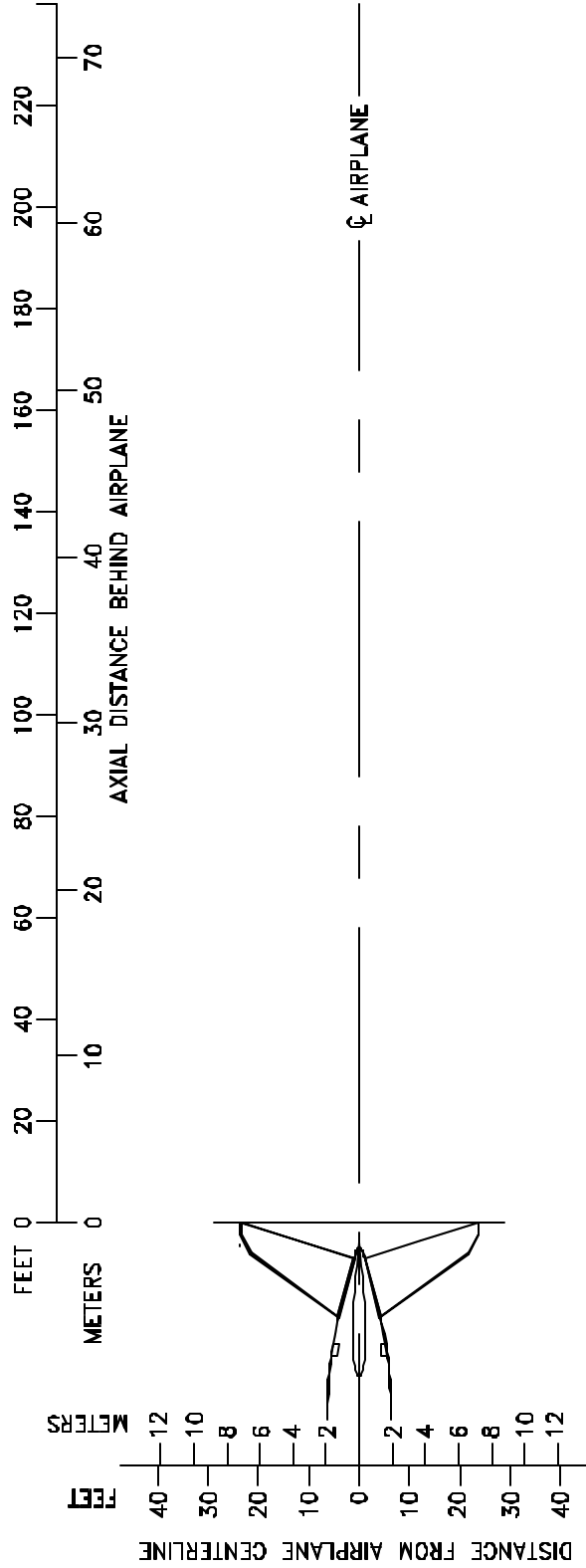
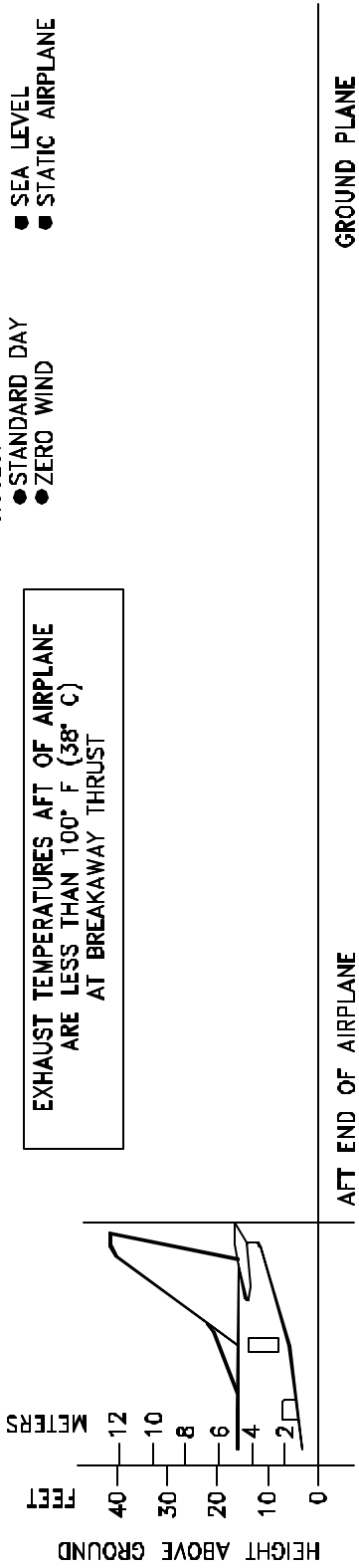

6.1.12 PREDICTED JET ENGINE EXHAUST TEMPERATURE CONTOURS
- IDLE THRUST
MODEL 737-600, -700, -800, -900 ALL MODELS

- NOTES:
- STANDARD DAY
 - ZERO WIND
 - SEA LEVEL
 - JT8D-17 ENGINES
 - STATIC AIRPLANE

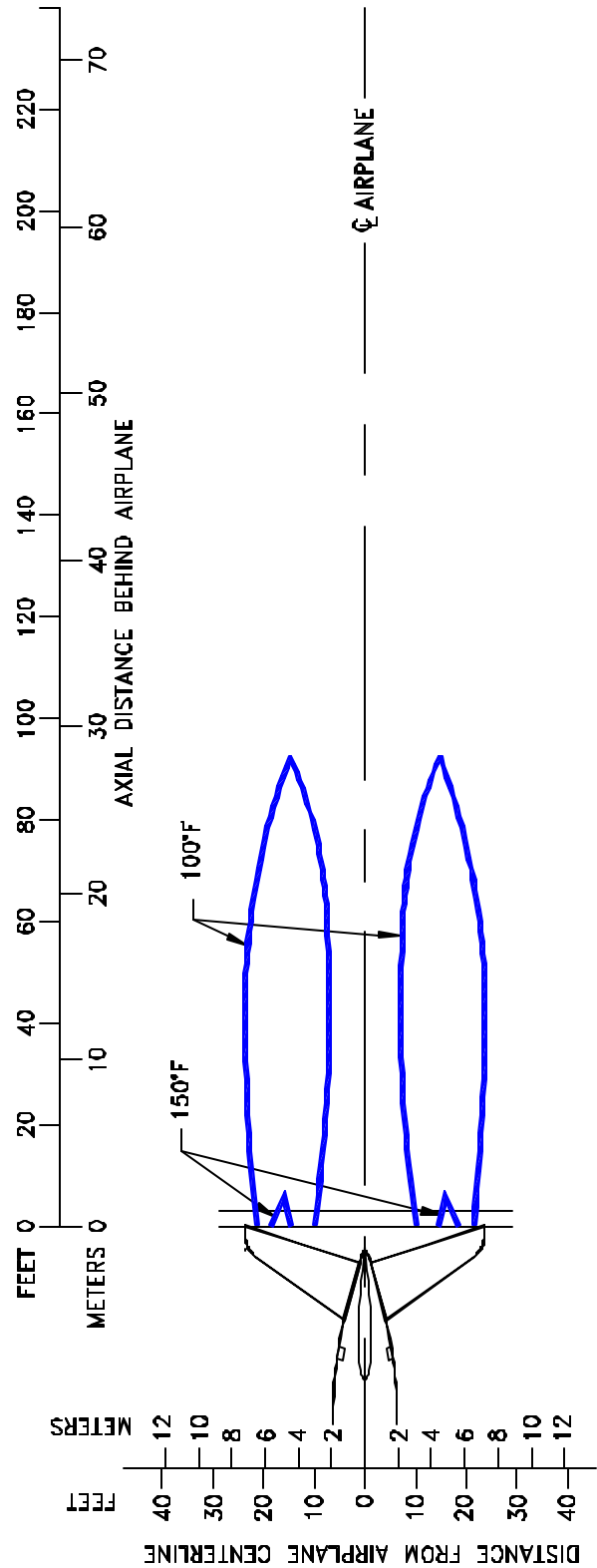
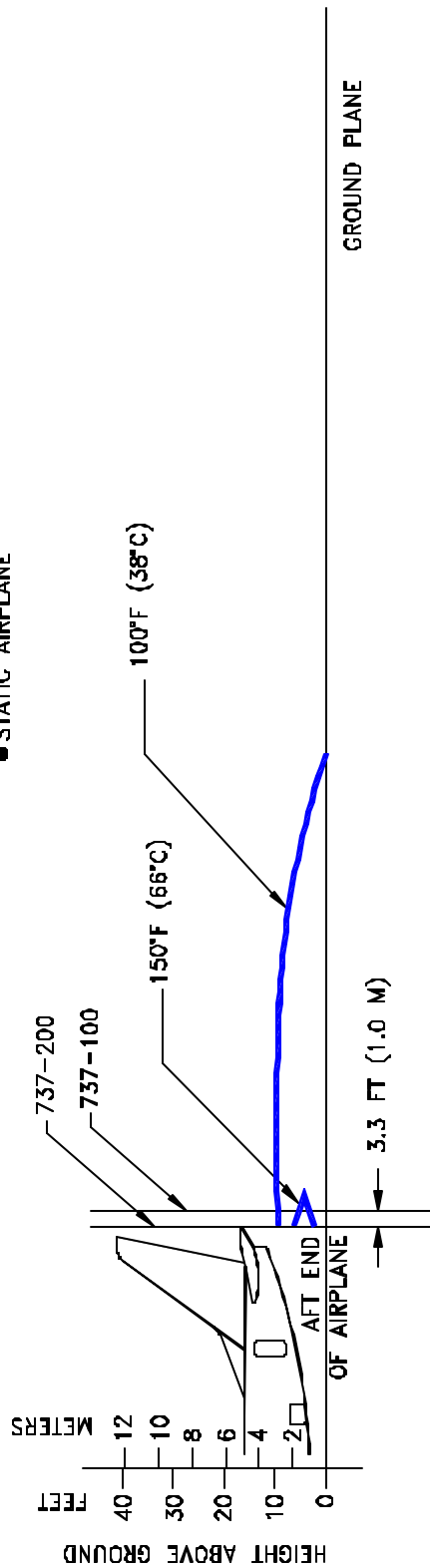

6.1.13 PREDICTED JET ENGINE EXHAUST TEMPERATURE CONTOURS
 - BREAKAWAY THRUST
 MODEL 737-100, -200

- NOTES:
- STANDARD DAY
 - ZERO WIND
 - SEA LEVEL
 - STATIC AIRPLANE

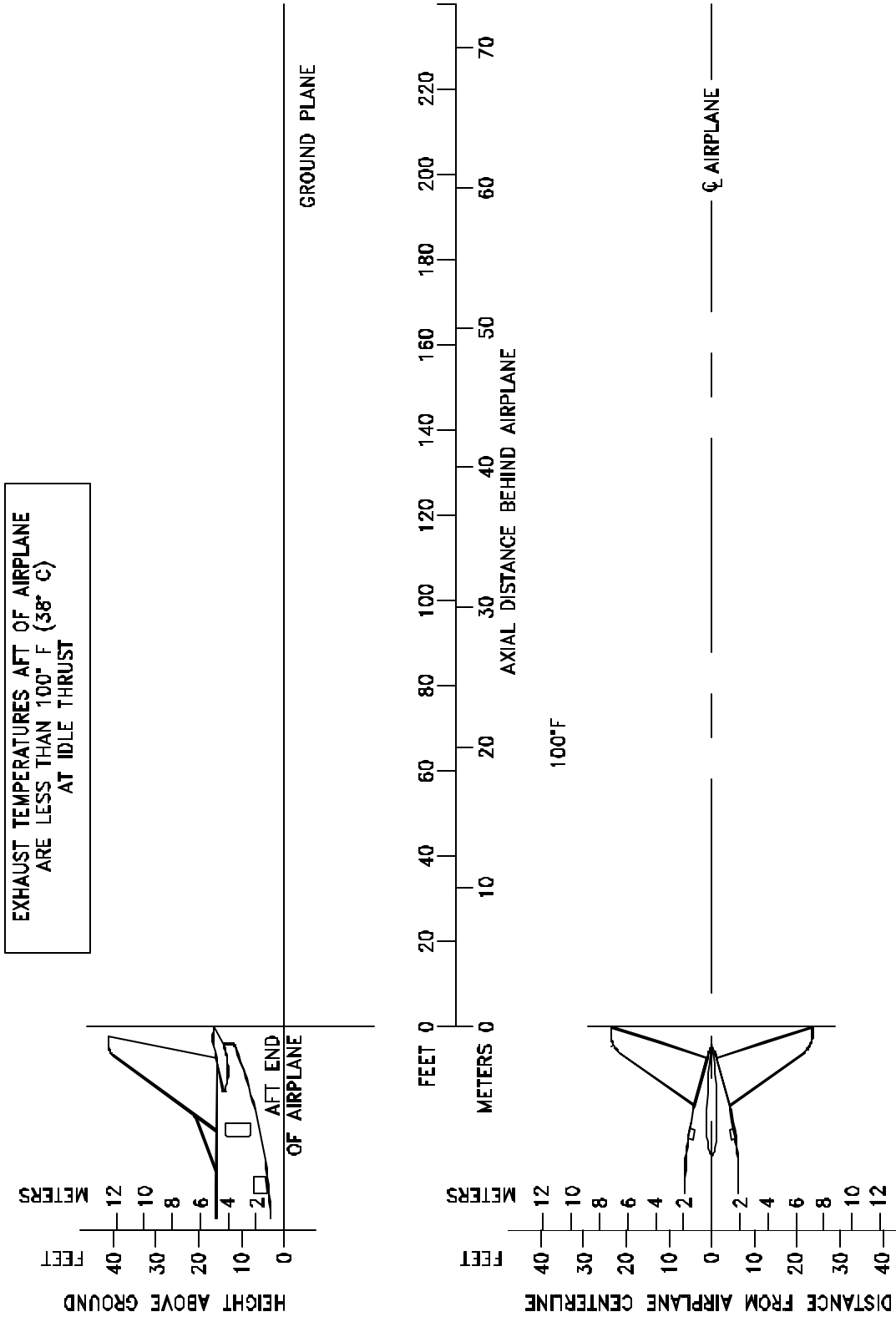

**6.1.14 PREDICTED JET ENGINE EXHAUST TEMPERATURE CONTOURS
 - BREAKAWAY THRUST**
MODEL 737-300, -400, -500

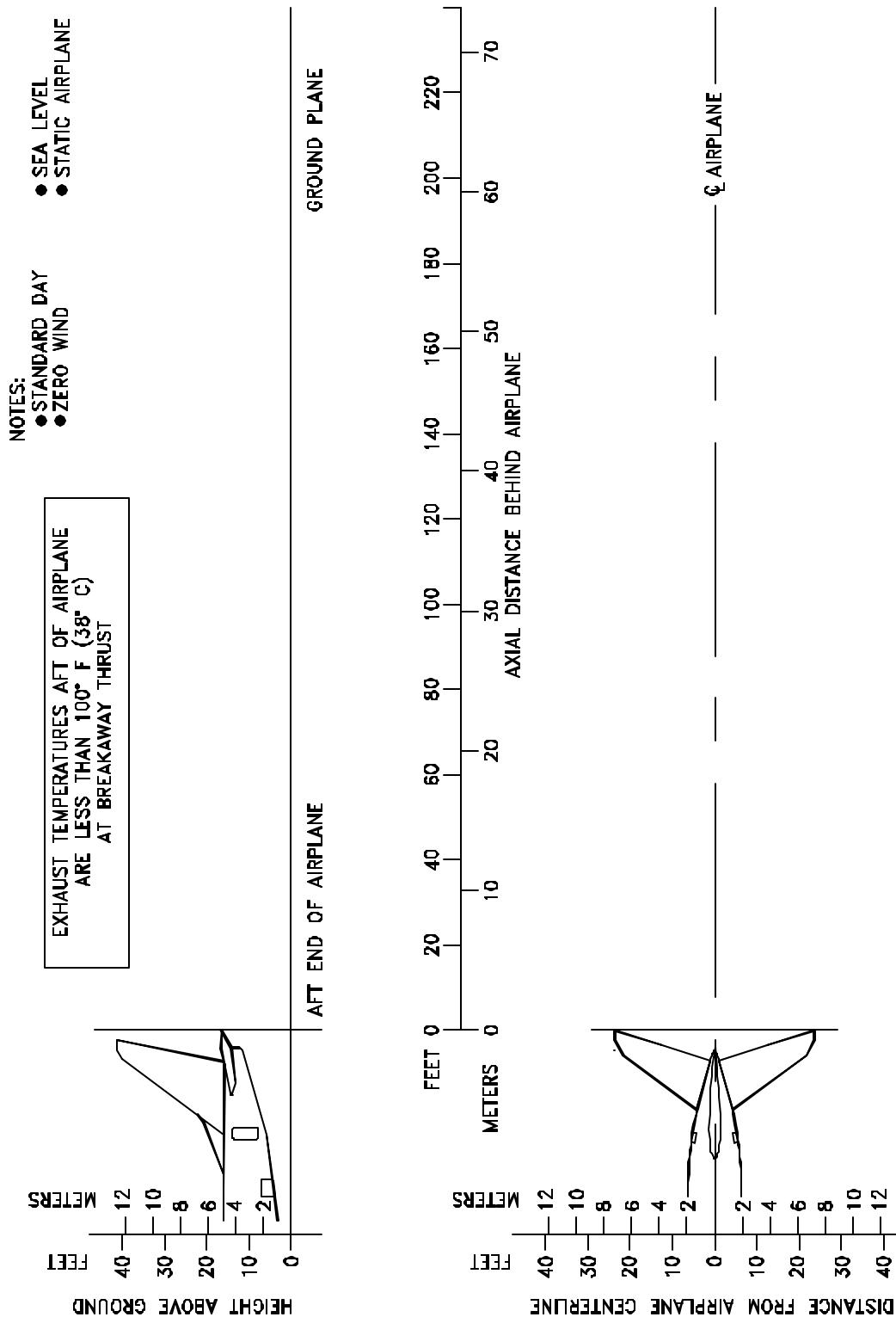

**6.1.15 PREDICTED JET ENGINE EXHAUST TEMPERATURE CONTOURS
- BREAKAWAY THRUST**

MODEL 737-600, -700, -800, -900 ALL MODELS

- NOTES:
- STANDARD DAY
 - ZERO WIND
 - SEA LEVEL
 - STATIC AIRPLANE
 - JT8D-17 ENGINES, OTHER JT8D ENGINES EXHIBIT SMALLER VELOCITY CONTOURS

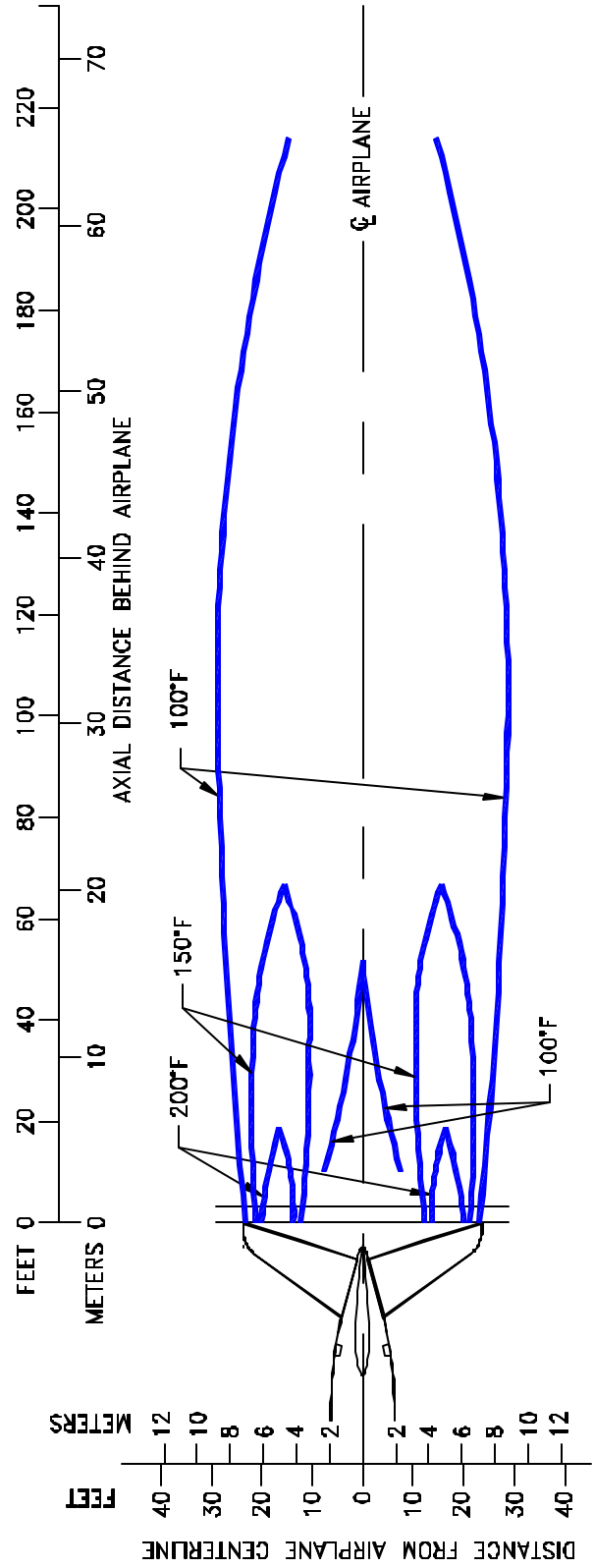
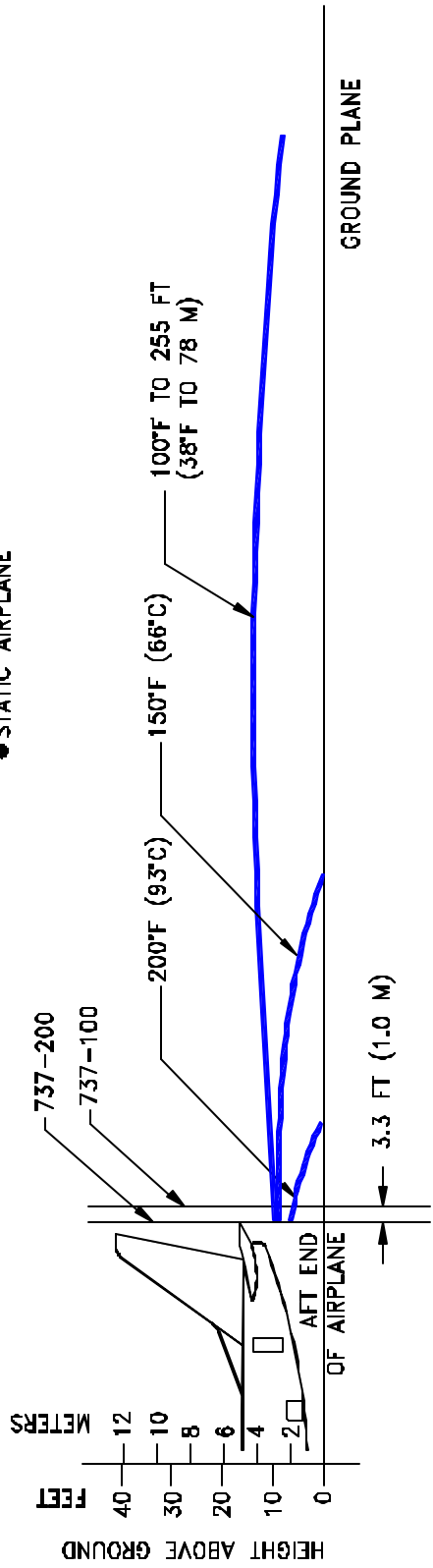

6.1.16 PREDICTED JET ENGINE EXHAUST TEMPERATURE CONTOURS
 - TAKEOFF THRUST
 MODEL 737-100, -200

- NOTES:
- STANDARD DAY
 - ZERO WIND
 - SEA LEVEL
 - STATIC AIRPLANE

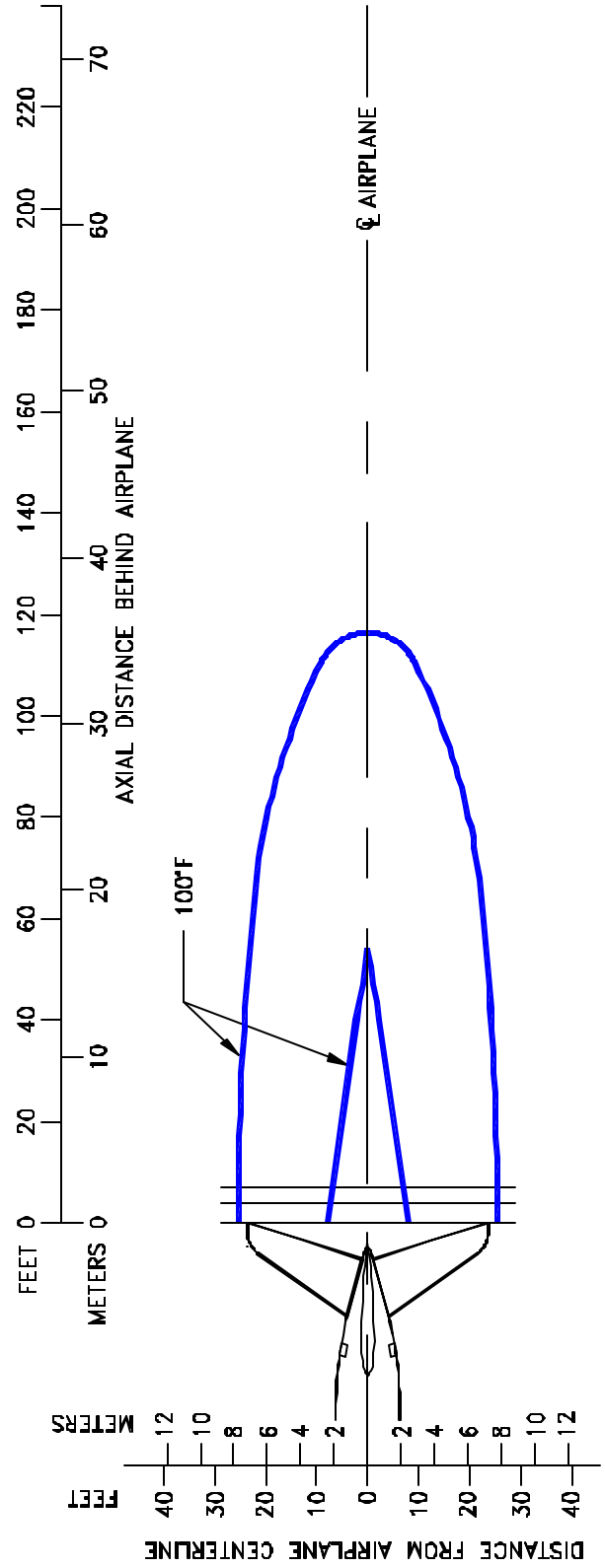
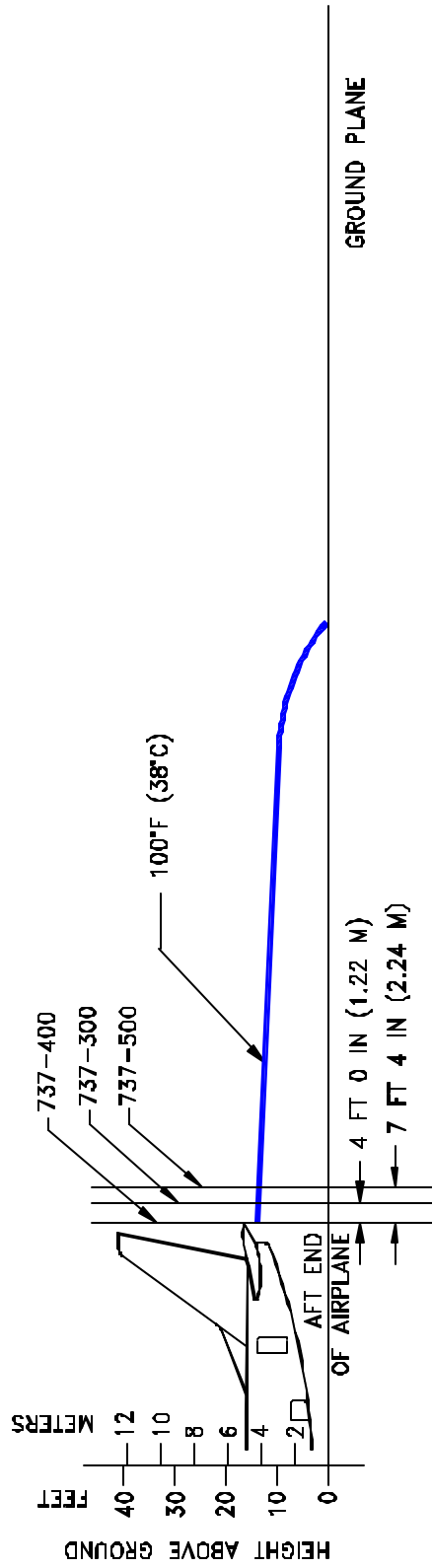

6.1.17 PREDICTED JET ENGINE EXHAUST TEMPERATURE CONTOURS
 - TAKEOFF THRUST
 MODEL 737-300, -400, -500

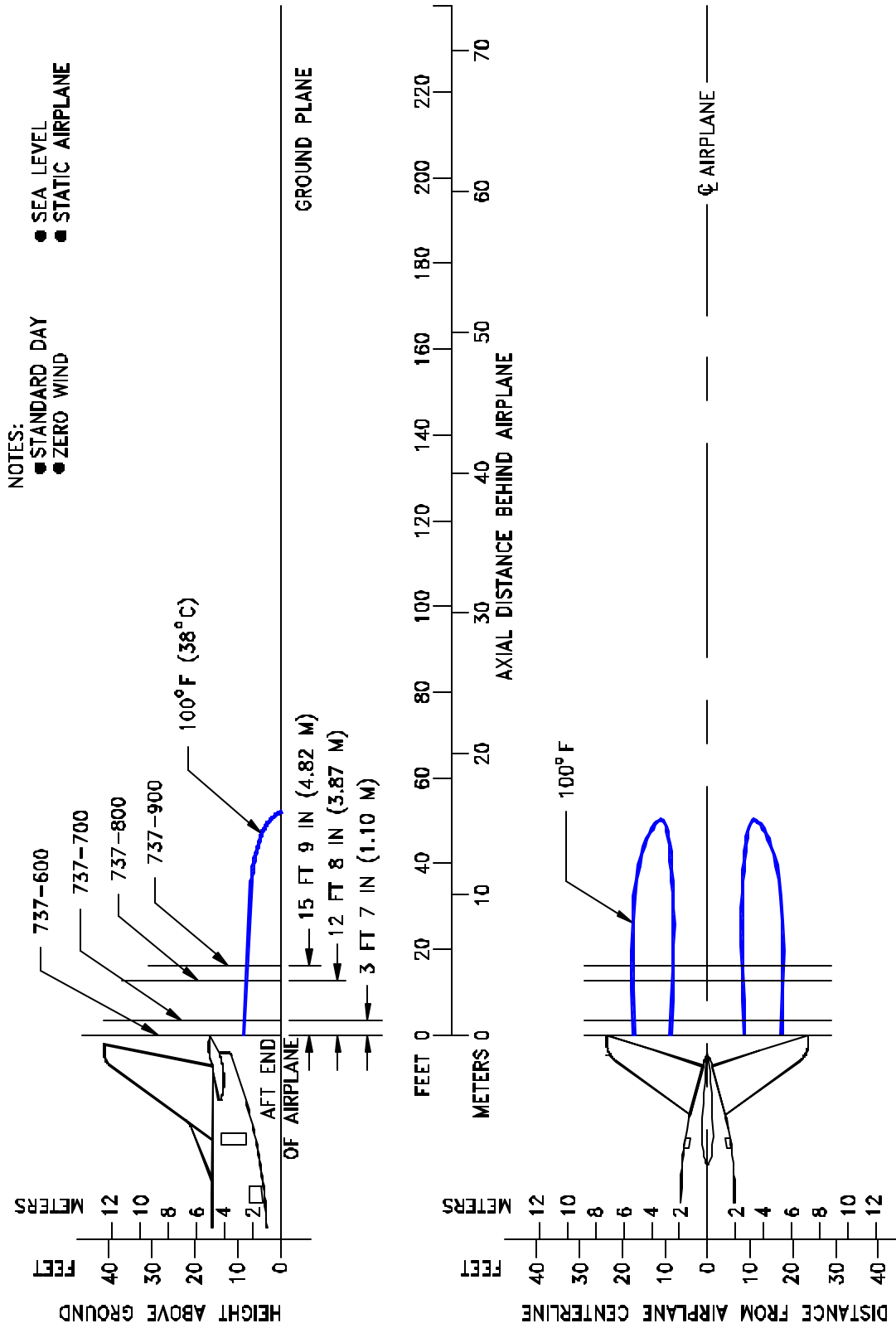

6.1.18 PREDICTED JET ENGINE EXHAUST TEMPERATURE CONTOURS
 - TAKEOFF THRUST
 MODEL 737-600, -700, -800, -900 ALL MODELS

6.2 Airport and Community Noise

Airport noise is of major concern to the airport and community planner. The airport is a major element in the community's transportation system and, as such, is vital to its growth. However, the airport must also be a good neighbor, and this can be accomplished only with proper planning. Since aircraft noise extends beyond the boundaries of the airport, it is vital to consider the impact on surrounding communities. Many means have been devised to provide the planner with a tool to estimate the impact of airport operations. Too often they oversimplify noise to the point where the results become erroneous. Noise is not a simple subject; therefore, there are no simple answers.

The cumulative noise contour is an effective tool. However, care must be exercised to ensure that the contours, used correctly, estimate the noise resulting from aircraft operations conducted at an airport.

The size and shape of the single-event contours, which are inputs into the cumulative noise contours, are dependent upon numerous factors. They include the following:

1. Operational Factors

- (a) Aircraft Weight-Aircraft weight is dependent on distance to be traveled, en route winds, payload, and anticipated aircraft delay upon reaching the destination.
- (b) Engine Power Settings-The rates of ascent and descent and the noise levels emitted at the source are influenced by the power setting used.
- (c) Airport Altitude-Higher airport altitude will affect engine performance and thus can influence noise.

2. Atmospheric Conditions-Sound Propagation

- (a) Wind-With stronger headwinds, the aircraft can take off and climb more rapidly relative to the ground. Also, winds can influence the distribution of noise in surrounding communities.
- (b) Temperature and Relative Humidity-The absorption of noise in the atmosphere along the transmission path between the aircraft and the ground observer varies with both temperature and relative humidity.

3. Surface Condition-Shielding, Extra Ground Attenuation (EGA)

- (a) Terrain-If the ground slopes down after takeoff or before landing, noise will be reduced since the aircraft will be at a higher altitude above ground. Additionally, hills, shrubs, trees, and large buildings can act as sound buffers.

All these factors can alter the shape and size of the contours appreciably. To demonstrate the effect of some of these factors, estimated noise level contours for two different operating conditions are shown below. These contours reflect a given noise level upon a ground level plane at runway elevation.

Condition 1

Landing

Takeoff

Maximum Structural Landing Weight
 10-knot Headwind
 3° Approach
 84 °F
 Humidity 15%

Maximum Gross Takeoff Weight
 Zero Wind
 84 °F
 Humidity 15%

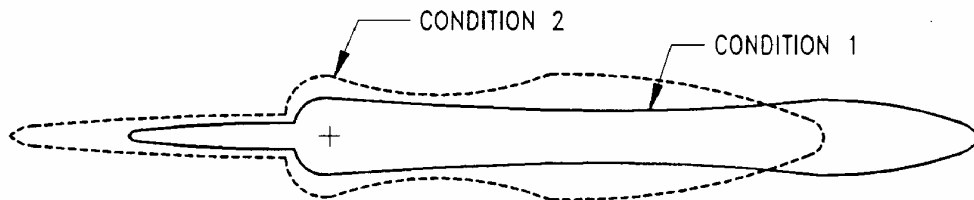

Condition 2

Landing:

Takeoff:

85% of Maximum Structural Landing Weight
 10-knot Headwind
 3° Approach
 59 °F
 Humidity 70%

80% of Maximum Gross Takeoff Weight
 10-knot Headwind
 59 °F
 Humidity 70%

As indicated from these data, the contour size varies substantially with operating and atmospheric conditions. Most aircraft operations are, of course, conducted at less than maximum gross weights because average flight distances are much shorter than maximum aircraft range capability and average load factors are less than 100%. Therefore, in developing cumulative contours for planning purposes, it is recommended that the airlines serving a particular city be contacted to provide operational information.

In addition, there are no universally accepted methods for developing aircraft noise contours or for relating the acceptability of specific zones to specific land uses. It is therefore expected that noise contour data for particular aircraft and the impact assessment methodology will be changing. To ensure that the best currently available information of this type is used in any planning study, it is recommended that it be obtained directly from the Office of Environmental Quality in the Federal Aviation Administration in Washington, D.C.

It should be noted that the contours shown herein are only for illustrating the impact of operating and atmospheric conditions and do not represent the single-event contour of the family of aircraft described in this document. It is expected that the cumulative contours will be developed as required by planners using the data and methodology applicable to their specific study.

7.0 PAVEMENT DATA

- 7.1 General Information**
- 7.2 Landing Gear Footprint**
- 7.3 Maximum Pavement Loads**
- 7.4 Landing Gear Loading on Pavement**
- 7.5 Flexible Pavement Requirements - U.S. Army Corps of Engineers Method S-77-1 and FAA Design Method**
- 7.6 Flexible Pavement Requirements - LCN Conversion**
- 7.7 Rigid Pavement Requirements - Portland Cement Association Design Method**
- 7.8 Rigid Pavement Requirements - LCN Conversion**
- 7.9 Rigid Pavement Requirements - FAA Design Method**
- 7.10 ACN/PCN Reporting System - Flexible and Rigid Pavements**
- 7.11 Tire Inflation Chart (737-100 thru -500 only)**

7.0 PAVEMENT DATA

7.1 General Information

A brief description of the pavement charts that follow will help in their use for airport planning. Each airplane configuration is depicted with a minimum range of five loads imposed on the main landing gear to aid in interpolation between the discrete values shown. All curves for any single chart represent data based on rated loads and tire pressures considered normal and acceptable by current aircraft tire manufacturer's standards. Tire pressures, where specifically designated on tables and charts, are at values obtained under loaded conditions as certificated for commercial use.

Section 7.2 presents basic data on the landing gear footprint configuration, maximum design taxi loads, and tire sizes and pressures.

Maximum pavement loads for certain critical conditions at the tire-to-ground interface are shown in Section 7.3, with the tires having equal loads on the struts.

Pavement requirements for commercial airplanes are customarily derived from the static analysis of loads imposed on the main landing gear struts. The charts in Section 7.4 are provided in order to determine these loads throughout the stability limits of the airplane at rest on the pavement. These main landing gear loads are used as the point of entry to the pavement design charts, interpolating load values where necessary.

The flexible pavement design curves (Section 7.5) are based on procedures set forth in Instruction Report No. S-77-1, "Procedures for Development of CBR Design Curves," dated June 1977, and as modified according to the methods described in FAA Advisory Circular 150/5320-6D, "Airport Pavement Design and Evaluation," dated July 7, 1995. Instruction Report No. S-77-1 was prepared by the U.S. Army Corps of Engineers Waterways Experiment Station, Soils and Pavements Laboratory, Vicksburg, Mississippi. The line showing 10,000 coverages is used to calculate Aircraft Classification Number (ACN).

The following procedure is used to develop the curves, such as shown in Section 7.5:

1. Having established the scale for pavement depth at the bottom and the scale for CBR at the top, an arbitrary line is drawn representing 5,000 annual departures.
2. Values of the aircraft gross weight are then plotted.
3. Additional annual departure lines are drawn based on the load lines of the aircraft gross weights already established.
4. An additional line representing 10,000 coverages (used to calculate the flexible pavement Aircraft Classification Number) is also placed.

All Load Classification Number (LCN) curves (Sections 7.6 and 7.8) have been developed from a computer program based on data provided in International Civil Aviation Organization (ICAO) document 9157-AN/901, Aerodrome Design Manual, Part 3, "Pavements", Second Edition, 1983. LCN values are shown directly for parameters of weight on main landing gear, tire pressure, and radius of relative stiffness (l) for rigid pavement or pavement thickness or depth factor (h) for flexible pavement.

Rigid pavement design curves (Section 7.7) have been prepared with the Westergaard equation in general accordance with the procedures outlined in the Design of Concrete Airport Pavement (1955 edition) by Robert G. Packard, published by the Portland Cement Association, 5420 Old Orchard Road, Skokie, Illinois 60077-1083. These curves are modified to the format described in the Portland Cement Association publication XP6705-2, Computer Program for Airport Pavement Design (Program PDILB), 1968, by Robert G. Packard.

The following procedure is used to develop the rigid pavement design curves shown in Section 7.7:

1. Having established the scale for pavement thickness to the left and the scale for allowable working stress to the right, an arbitrary load line is drawn representing the main landing gear maximum weight to be shown.
2. Values of the subgrade modulus (k) are then plotted.
3. Additional load lines for the incremental values of weight on the main landing gear are drawn on the basis of the curve for $k = 300$, already established.

The rigid pavement design curves (Section 7.9) have been developed based on methods used in the FAA Advisory Circular AC 150/5320-6D July 7, 1995. The following procedure is used to develop the curves, such as shown in Section 7.9:

1. Having established the scale for pavement flexure strength on the left and temporary scale for pavement thickness on the right, an arbitrary load line is drawn representing the main landing gear maximum weight to be shown at 5,000 coverages.
2. Values of the subgrade modulus (k) are then plotted.
3. Additional load lines for the incremental values of weight are then drawn on the basis of the subgrade modulus curves already established.
4. The permanent scale for the rigid-pavement thickness is then placed. Lines for other than 5,000 coverages are established based on the aircraft pass-to-coverage ratio.

The ACN/PCN system (Section 7.10) as referenced in ICAO Annex 14, "Aerodromes," 3rd Edition, July 1999, provides a standardized international airplane/pavement rating system replacing the various S, T, TT, LCN, AUW, ISWL, etc., rating systems used throughout the world. ACN is the Aircraft Classification Number and PCN is the Pavement Classification Number. An aircraft having an ACN equal to or less than the PCN can operate on the pavement subject to any limitation on the tire pressure. Numerically, the ACN is two times the derived single-wheel load expressed in thousands of kilograms, where the derived single wheel load is defined as the load on a single tire inflated to 181 psi (1.25 MPa) that would have the same pavement requirements as the aircraft. Computationally, the ACN/PCN system uses the PCA program PDILB for rigid pavements and S-77-1 for flexible pavements to calculate ACN values. The method of pavement evaluation is left up to the airport with the results of their evaluation presented as follows:

PCN	PAVEMENT TYPE	SUBGRADE CATEGORY	TIRE PRESSURE CATEGORY	EVALUATION METHOD
	R = Rigid F = Flexible	A = High B = Medium C = Low D = Ultra Low	W = No Limit X = To 217 psi (1.5 MPa) Y = To 145 psi (1.0 MPa) Z = To 73 psi (0.5 MPa)	T = Technical U = Using Aircraft

ACN values for flexible pavements are calculated for the following four subgrade categories:

- Code A - High Strength - CBR 15
- Code B - Medium Strength - CBR 10
- Code C - Low Strength - CBR 6
- Code D - Ultra Low Strength - CBR 3

ACN values for rigid pavements are calculated for the following four subgrade categories:

- Code A - High Strength, $k = 550 \text{ pci (150 MN/m}^3\text{)}$
- Code B - Medium Strength, $k = 300 \text{ pci (80 MN/m}^3\text{)}$
- Code C - Low Strength, $k = 150 \text{ pci (40 MN/m}^3\text{)}$
- Code D - Ultra Low Strength, $k = 75 \text{ pci (20 MN/m}^3\text{)}$

DRAWING
NOT TO SCALE

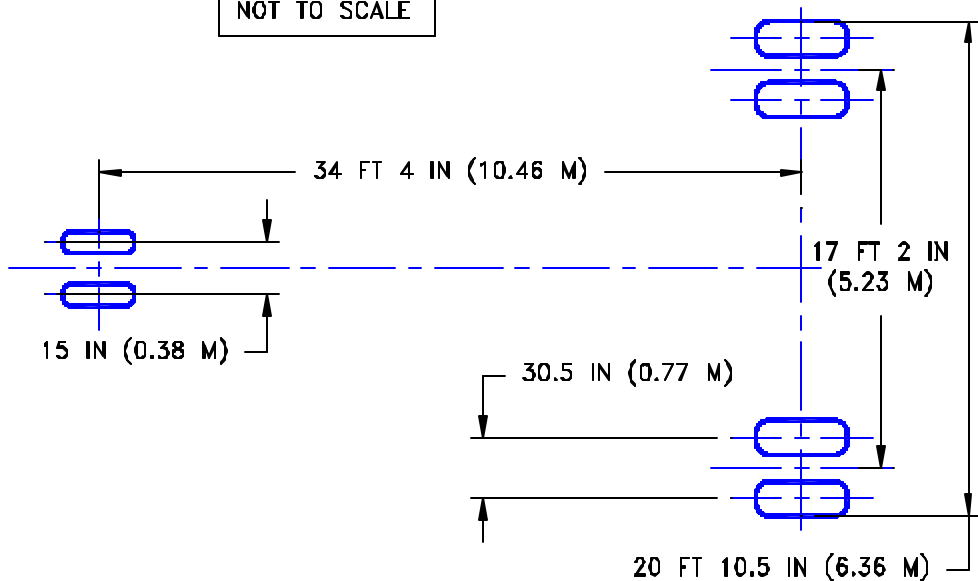

MAXIMUM DESIGN TAXI WEIGHT	MODEL 737-100			
	LB	97,800	104,000	111,000
KG	44,361	47,174	50,349	
PERCENT OF WEIGHT ON MAIN GEAR	SEE SECTION 7.4			
NOSE GEAR TIRE SIZE	IN	24 x 7.7 - 10 14 PR		24 x 7.7 - 10 16 PR
NOSE GEAR TIRE PRESSURE	PSI	135	135	145
	KG/CM ²	9.49	9.49	10.19
MAIN GEAR TIRE SIZE	IN	40 x 14 - 16 22 PR	40 x 14 - 16 22 PR	40 x 14 - 16 24 PR
MAIN GEAR TIRE PRESSURE	PSI	138	146	157
	KG/CM ²	9.70	10.27	11.04

7.2.1 LANDING GEAR FOOTPRINT
MODEL 737-100

DRAWING
NOT TO SCALE

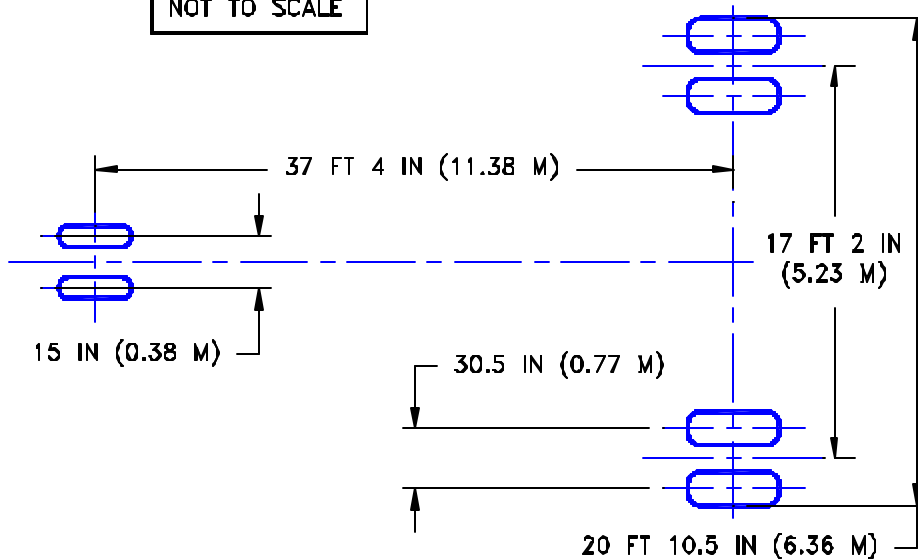

MAXIMUM DESIGN TAXI WEIGHT	MODEL 737-200					
	LB	100,800	104,000	110,000	111,000	116,000
	KG	45,722	47,174	49,895	50,349	52,617
PERCENT OF WEIGHT ON MAIN GEAR	SEE SECTION 7.4					

STANDARD TIRES AND BRAKES

NOSE GEAR TIRE SIZE	IN	24 x 7.7 – 10 14 PR		24 x 7.7 – 10 16 PR		
NOSE GEAR TIRE PRESSURE	PSI	135	135	145	145	145
	KG/CM ²	9.49	9.49	10.19	10.19	10.19
MAIN GEAR TIRE SIZE	IN	40 x 14 – 16 22 PR		40 x 14 – 16 24 PR		
MAIN GEAR TIRE PRESSURE	PSI	141	146	156	157	158
	KG/CM ²	9.91	10.27	10.97	11.04	11.67

HEAVY-DUTY TIRES AND BRAKES

NOSE GEAR TIRE SIZE	IN	24 x 7.7 – 10 16 PR				
NOSE GEAR TIRE PRESSURE	PSI	145	145	145	145	145
	KG/CM ²	10.19	10.19	10.19	10.19	10.19
MAIN GEAR TIRE SIZE	IN	C40 X 14 – 21 22 PR		C40 X 14 – 21 24 PR		
MAIN GEAR TIRE PRESSURE	PSI	141	146	156	157	164
	KG/CM ²	9.91	10.27	10.97	11.04	11.53

7.2.2 LANDING GEAR FOOTPRINT

MODEL 737-200

NOTE: SEE PREVIOUS PAGE FOR TIRE LAYOUT

MAXIMUM DESIGN TAXI WEIGHT	MODEL ADVANCED 737-200					
	LB	116,000	117,500	120,000	125,000	128,600
	KG	52,617	53,297	54,431	56,699	58,332
PERCENT OF WEIGHT ON MAIN GEAR	SEE SECTION 7.4					

STANDARD TIRES AND BRAKES

NOSE GEAR TIRE SIZE	IN	24 x 7.7 – 10 16 PR			(NOT AVAILABLE)
NOSE GEAR TIRE PRESSURE	PSI	140			
	KG/CM ²	9.84			
MAIN GEAR TIRE SIZE	IN	40 x 14 – 16 24 PR			
MAIN GEAR TIRE PRESSURE	PSI	166	168	172	
	KG/CM ²	11.67	11.81	12.09	

HEAVY-DUTY TIRES AND BRAKES

NOSE GEAR TIRE SIZE	IN	24 x 7.7 – 10 16 PR			
NOSE GEAR TIRE PRESSURE	PSI	140			
	KG/CM ²	9.84			
MAIN GEAR TIRE SIZE	IN	C40 X 14 – 21 24 PR			C40 X 14 – 21 26 PR OR H40 x 14.5 – 19 24 PR
MAIN GEAR TIRE PRESSURE	PSI	164	166	170	178 182
	KG/CM ²	11.53	11.67	11.95	12.52 12.80

LOW PRESSURE TIRES

NOSE GEAR TIRE SIZE	IN	C24.5 x 18.5 – 12 12 PR	C24.5 x 18.5 – 12 12 PR	(NOT AVAILABLE)
NOSE GEAR TIRE PRESSURE	PSI	104	104	
	KG/CM ²	7.31	7.31	
MAIN GEAR TIRE SIZE	IN	C40 X 18 - 17 20 PR	C40 X 18 - 17 20 PR	
MAIN GEAR TIRE PRESSURE	PSI	95	96	
	KG/CM ²	6.68	6.75	

7.2.3 LANDING GEAR FOOTPRINT

MODEL ADVANCED 737-200

D6-58325-6

DRAWING
NOT TO SCALE

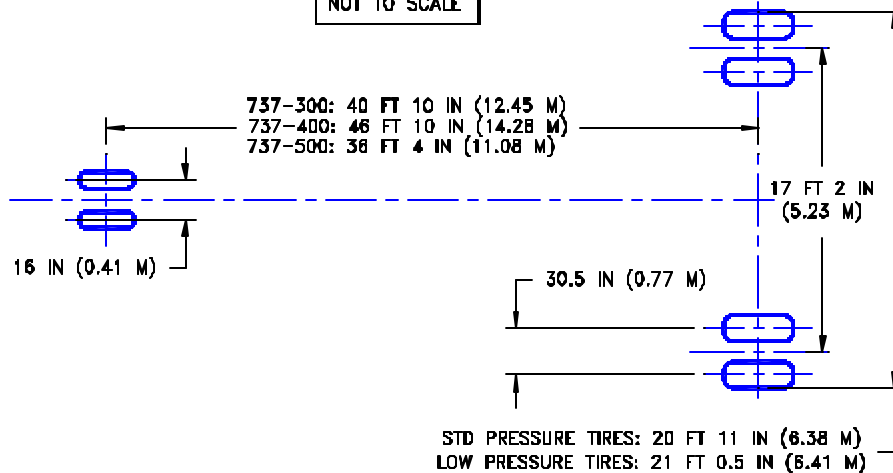

		737-300	737-400				737-500
MAXIMUM DESIGN TAXI WEIGHT	LB	125,000 TO 140,000	139,000	143,000	144,000	150,500	116,000 TO 134,000
	KG	56,699 TO 63,503	63,049	64,864	65,317	68,266	52,617 TO 60,781
PERCENT OF WEIGHT ON MAIN GEAR	SEE SECTION 7.4						

STANDARD TIRES AND BRAKES

NOSE GEAR TIRE SIZE	IN	140	40 x 14 - 16 24 PR				24 x 7.7 - 10 16 PR
NOSE GEAR TIRE PRESSURE	PSI	166	171	172	173	177	186
	KG/CM ²	11.67	12.02	12.09	12.16	12.44	13.08
MAIN GEAR TIRE SIZE	IN	H40 x 14.5 - 19 24 PR	H40 x 14.5 - 19 26 PR		H42 x 16 - 19 26 PR	H40 x 14.5 - 19 24 PR	
MAIN GEAR TIRE PRESSURE (1)	PSI	180 TO 201	203	209	211	185	170 TO 194
	KG/CM ²	12.65 TO 14.13	14.27	14.69	14.83	13.00	11.95 TO 13.64

LOW PRESSURE TIRES

NOSE GEAR TIRE SIZE	IN	24 x 7.75 - 15 10 PR	24 x 7.75 - 15 12 PR				24 x 7.75 - 15 12 PR
NOSE GEAR TIRE PRESSURE	PSI	166	171	172	173	(NA)	186
	KG/CM ²	11.67	12.02	12.09	12.16	(NA)	13.08
MAIN GEAR TIRE SIZE	IN	H42 X 16 - 19 24 PR	H42 X 16 - 19 24 PR			(NA)	H42 X 16 - 19 24 PR
MAIN GEAR TIRE PRESSURE (1)	PSI	152 TO 170	171	176	177	(NA)	144 TO 164
	KG/CM ²	10.69 TO 11.95	12.02	12.37	12.44	(NA)	10.12 TO 11.53

NOTE: (1) SEE SEC 7.11 - TIRE INFLATION CHART, FOR TIRE PRESSURES AT INTERMEDIATE WEIGHTS.

7.2.4 LANDING GEAR FOOTPRINT

MODEL 737-300, -400, -500

DRAWING
NOT TO SCALE

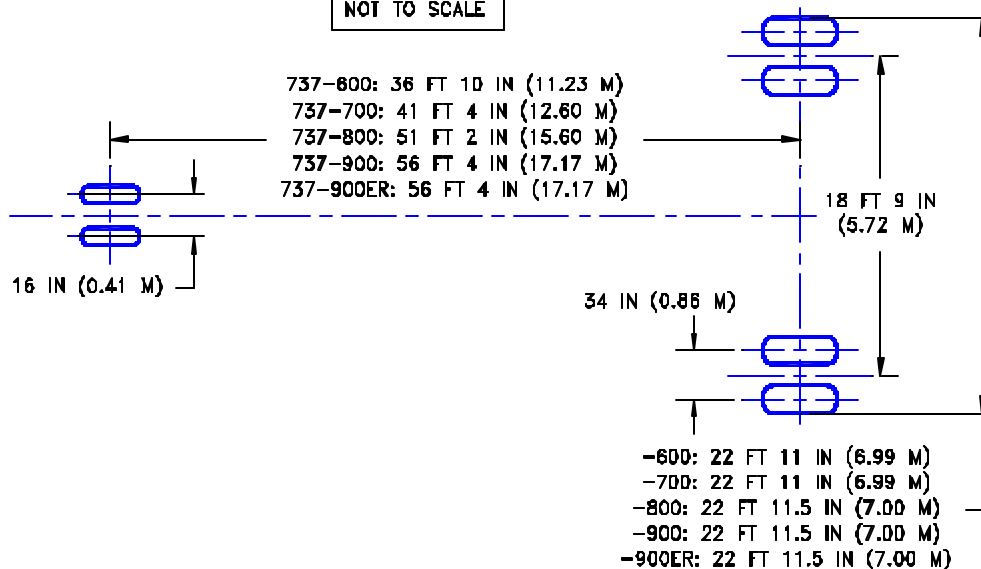

	UNITS	737-600	737-700	737-800	737-900	737-900ER
MAXIMUM DESIGN	LB	124,500 THRU 145,000	133,500 THRU 155,000	156,000 THRU 174,700	164,500 THRU 174,700	164,500 THRU 188,200
TAXI WEIGHT	KG	56,472 THRU 65,771	60,554 THRU 70,307	70,760 THRU 79,242	74,616 THRU 79,242	74,616 THRU 85,366
NOSE GEAR TIRE SIZE	IN.	27 x 7.7 - 15 12 PR			27 x 7.75 - 15 12 PR	27 x 7.75 - 15 12 PR
NOSE GEAR TIRE PRESSURE	PSI	206	205	185	185	185
	KG/CM ²	14.50	14.44	13.03	13.03	13.03
MAIN GEAR TIRE SIZE	IN.	H43.5 x 16.0 - 21 24PR OR 26 PR	H43.5 x 16.0 - 21 26 PR	H44.5 x 16.5 - 21 28 PR	H44.5 x 16.5 - 21 28 PR	H44.5 x 16.5 - 21 30 PR
MAIN GEAR TIRE PRESSURE	PSI	182 THRU 205	197THRU 205	204 THRU 205	204 THRU 205	205 THRU 220
	KG/CM ²	12.80 THRU 14.41	13.85 THRU 14.41	14.39 THRU 14.41	14.34 THRU 14.41	14.41 THRU 15.47

OPTIONAL TIRES

MAIN GEAR TIRE SIZE	IN.	H44.5 x 16.5 - 21 28PR (1)	H44.5 x 16.5 - 21 28PR	NOT AVAILABLE	NOT AVAILABLE	NOT AVAILABLE
MAIN GEAR TIRE PRESSURE	PSI	168 THRU 205	179 THRU 205	NOT AVAILABLE	NOT AVAILABLE	NOT AVAILABLE
	KG/CM ²	11.81THRU 14.41	12.59 THRU 14.41	NOT AVAILABLE	NOT AVAILABLE	NOT AVAILABLE

NOTE: (1) H44.5 x 16.5 - 21 28PR TIRE CERTIFICATED ON 737-600 UP TO 144,000 LB (65,317 KG)

7.2.5 LANDING GEAR FOOTPRINT

MODEL 737-600, -700, -800, -900, -900ER WITH AND WITHOUT WINGLETS

DRAWING
NOT TO SCALE

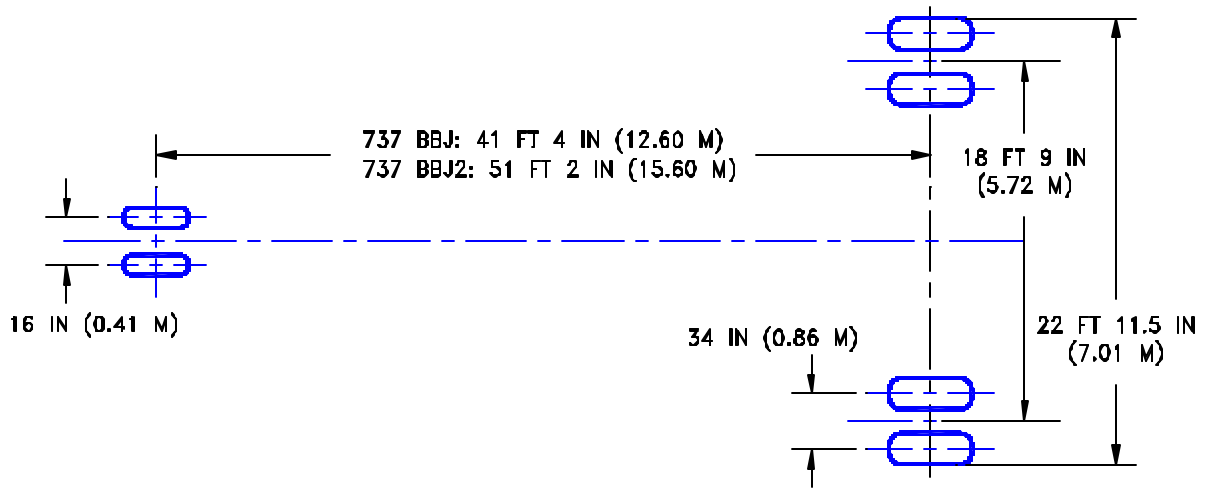

	UNITS	737 BBJ	737 BBJ2
MAXIMUM DESIGN TAXI WEIGHT	LB	171,500	174,700
	KG	77,790	79,250
		SEE SECTION 7.4	
PERCENT OF WEIGHT ON MAIN GEAR		SEE SECTION 7.4	
NOSE GEAR TIRE SIZE	IN.	27 x 7.7 - 15 12 PR	
NOSE GEAR TIRE PRESSURE	PSI	185	185
	KG/CM ²	13.03	13.03
MAIN GEAR TIRE SIZE	IN.	H44.5 x 16.5 - 21 28 PR	H44.5 x 16.5 - 21 28 PR
MAIN GEAR TIRE PRESSURE	PSI	204	204
	KG/CM ²	14.34	14.34

7.2.6 LANDING GEAR FOOTPRINT
MODEL 737 BBJ, 737 BBJ2

V_{NG} = MAXIMUM VERTICAL NOSE GEAR GROUND LOAD AT MOST FORWARD CENTER OF GRAVITY

V_{MG} = MAXIMUM VERTICAL MAIN GEAR GROUND LOAD AT MOST AFT CENTER OF GRAVITY

H = MAXIMUM HORIZONTAL GROUND LOAD FROM BRAKING

NOTE: ALL LOADS CALCULATED USING AIRPLANE MAXIMUM DESIGN TAXI WEIGHT

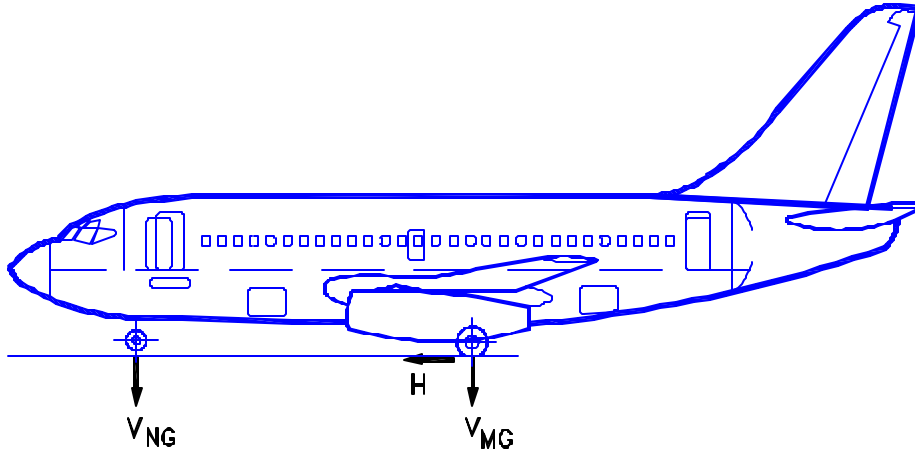

MODEL	UNITS	MAXIMUM DESIGN TAXI WEIGHT	V_{NG}		V_{MG} PER STRUT AT MAX LOAD AT STATIC AFT C.G.	H PER STRUT	
			STATIC AT MOST FWD C.G.	STATIC + BRAKING 10 FT/SEC ² DECEL		STEADY BRAKING 10 FT/SEC ² DECEL	AT INSTANTANEOUS BRAKING ($\mu=0.8$)
737-100	LB	97,800	14,000	21,500	45,200	15,100	36,200
	KG	44,362	6,350	9,752	20,503	6,849	16,420
737-100,-200	LB	104,000	18,200	24,000	48,000	16,100	38,400
	KG	47,174	8,255	10,886	21,773	7,303	17,418
737-200,200	LB	111,000	17,700	25,600	51,000	17,300	40,800
	KG	50,349	8,029	11,612	23,133	7,847	18,507
737-200,200C	LB	116,000	16,500	25,200	52,800	18,000	42,200
	KG	52,617	7,484	11,431	23,950	8,165	19,142
737-200,200C	LB	117,500	15,800	23,500	54,500	18,200	43,600
	KG	53,298	7,167	10,660	24,721	8,255	19,777
737-200	LB	100,800	14,700	21,400	46,800	13,800	37,500
	KG	45,723	6,668	9,707	21,228	6,260	17,010
737-200	LB	110,000	16,100	24,000	51,000	17,000	40,800
	KG	49,896	7,303	10,886	23,133	7,711	18,507
737-200,200C	LB	120,000	16,500	24,500	55,600	16,800	44,500
	KG	54,432	7,484	11,113	25,220	7,620	20,185
737-200,200C	LB	125,000	16,400	24,700	57,900	19,400	46,300
	KG	56,700	7,439	11,204	26,263	8,800	21,002
737-200,200C	LB	128,600	14,200	22,800	59,100	20,000	47,300
	KG	58,333	6,441	10,342	26,808	9,072	21,455

7.3.1 MAXIMUM PAVEMENT LOADS

MODEL 737-100, -200

V_{NG} = MAXIMUM VERTICAL NOSE GEAR GROUND LOAD AT MOST FORWARD CENTER OF GRAVITY

V_{MG} = MAXIMUM VERTICAL MAIN GEAR GROUND LOAD AT MOST AFT CENTER OF GRAVITY

H = MAXIMUM HORIZONTAL GROUND LOAD FROM BRAKING

NOTE: ALL LOADS CALCULATED USING AIRPLANE MAXIMUM DESIGN TAXI WEIGHT

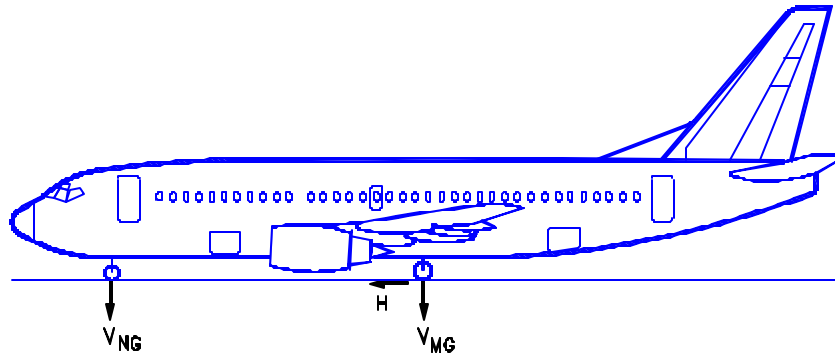

MODEL	UNITS	MAXIMUM DESIGN TAXI WEIGHT	V_{NG}		V_{MG} PER STRUT AT MAX LOAD AT STATIC AFT C.G.	H PER STRUT	
			STATIC AT MOST FWD C.G.	STATIC + BRAKING 10 FT/SEC ² DECEL		STEADY BRAKING 10 FT/SEC ² DECEL	AT INSTANTANEOUS BRAKING ($\mu=0.8$)
737-300	LB	125,000	154,000	22,700	58,300	19,400	46,600
	KG	56,700	69,854	10,297	26,445	8,800	21,138
737-300	LB	130,500	15,300	23,100	60,600	20,300	48,500
	KG	59,194	6,940	10,478	27,488	9,208	21,999
737-300	LB	135,500	15,200	23,400	62,200	21,000	49,800
	KG	61,462	6,895	10,614	28,214	9,526	22,589
737-300	LB	137,500	15,600	24,300	63,200	21,400	50,500
	KG	62,370	7,076	11,022	28,667	9,707	22,907
737-300	LB	139,000	15,600	24,400	63,600	21,600	50,900
	KG	63,050	7,076	11,068	28,849	9,798	23,088
737-300	LB	140,000	14,500	23,400	63,600	21,700	50,900
	KG	63,504	6,577	10,614	28,849	9,843	23,088
737-400	LB	139,000	15,900	23,000	64,900	21,600	51,900
	KG	63,050	7,212	10,433	29,438	9,798	23,542
737-400	LB	143,000	16,000	20,800	67,100	22,200	53,700
	KG	64,864	7,258	9,435	30,436	10,070	24,358
737-400	LB	144,000	12,200	19,700	66,900	22,400	56,500
	KG	65,318	5,534	8,936	30,346	10,161	25,628
737-400	LB	150,500	16,500	24,400	70,600	23,400	56,500
	KG	68,266	7,484	11,068	32,024	10,614	25,628
737-500	LB	116,000	17,100	25,000	53,700	18,000	42,900
	KG	52,617	7,757	11,340	24,358	8,165	19,459
737-500	LB	125,000	17,300	25,800	57,700	19,400	46,200
	KG	56,700	7,847	11,703	26,173	8,800	20,956
737-500	LB	134,000	17,300	26,400	61,800	20,800	49,400
	KG	60,781	7,847	11,975	28,032	9,435	22,407

7.3.2 MAXIMUM PAVEMENT LOADS

MODEL 737-300, -400, -500

V_{NG} = MAXIMUM VERTICAL NOSE GEAR GROUND LOAD AT MOST FORWARD CENTER OF GRAVITY

V_{MG} = MAXIMUM VERTICAL MAIN GEAR GROUND LOAD AT MOST AFT CENTER OF GRAVITY

H = MAXIMUM HORIZONTAL GROUND LOAD FROM BRAKING

NOTE: ALL LOADS CALCULATED USING AIRPLANE MAXIMUM DESIGN TAXI WEIGHT

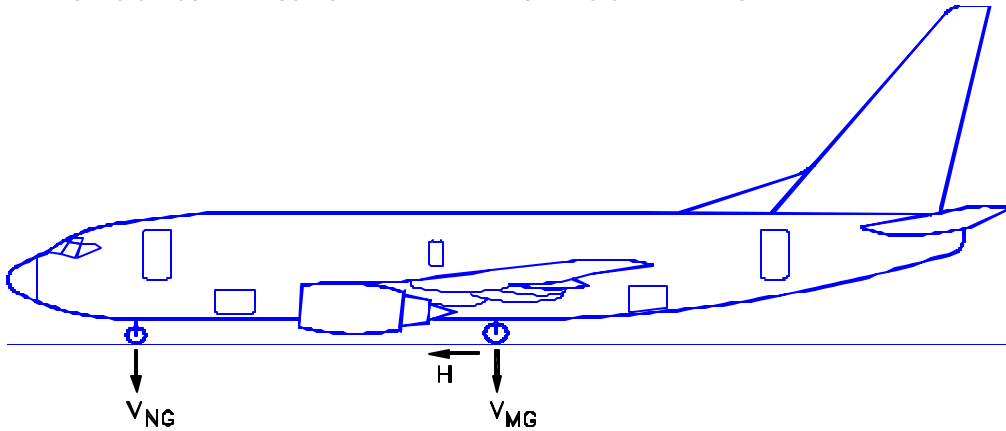

MODEL	UNITS	MAXIMUM DESIGN TAXI WEIGHT	V_{NG}		V_{MG} PER STRUT AT MAX LOAD AT STATIC AFT C.G.	H PER STRUT	
			STATIC AT MOST FWD C.G.	STATIC + BRAKING 10 FT/SEC ² DECEL		STEADY BRAKING 10 FT/SEC ² DECEL	AT INSTANTANEOUS BRAKING ($\mu=0.8$)
737-600	LB	124,500	16,839	26,489	58,333	19,298	46,666
	KG	56,472	7,638	12,015	26,459	8,708	21,167
737-600	LB	144,000	19,020	30,180	66,708	22,320	53,366
	KG	65,317	8,627	13,689	30,258	10,124	24,206
737-600	LB	145,000	19,000	30,236	66,454	22,475	53,163
	KG	65,771	8,618	13,715	30,143	10,194	24,114
737-700	LB	133,500	17,558	26,711	63,000	20,692	50,400
	KG	60,554	7,963	12,116	28,576	9,386	22,861
737-700	LB	153,500	18,740	29,265	71,482	23,792	57,185
	KG	69,626	8,500	13,274	32,424	10,792	25,939
737-700	LB	155,000	16,925	27,552	71,060	24,025	56,847
	KG	70,307	7,677	12,497	32,232	10,898	25,785
737-800	LB	156,000	16,770	25,510	75,062	24,180	60,050
	KG	70,750	7,607	11,571	34,047	10,968	27,442
737-800	LB	173,000	17,059	26,752	82,143	26,815	65,715
	KG	78,471	7,738	12,134	37,259	12,163	29,808
737-800	LB	174,700	15,100	24,886	81,730	27,078	65,384
	KG	79,242	6,849	11,279	37,060	12,282	29,658
737-900	LB	164,500	14,998	23,369	78,962	25,498	63,169
	KG	74,616	6,803	10,600	35,817	11,566	28,653
737-900	LB	174,700	14,155	23,045	81,743	27,078	65,394
	KG	79,242	6,421	10,453	37,078	12,282	29,662
737-900ER	LB	188,200	15,206	24,810	88,993	29,227	71,194
	KG	85,366	6,897	11,254	40,367	13,257	32,293

7.3.3 MAXIMUM PAVEMENT LOADS

MODEL 737-600, -700, -800, -900, -900ER WITH AND WITHOUT WINGLETS

V_{NG} = MAXIMUM VERTICAL NOSE GEAR GROUND LOAD AT MOST FORWARD CENTER OF GRAVITY

V_{MG} = MAXIMUM VERTICAL MAIN GEAR GROUND LOAD AT MOST AFT CENTER OF GRAVITY

H = MAXIMUM HORIZONTAL GROUND LOAD FROM BRAKING

NOTE: ALL LOADS CALCULATED USING AIRPLANE MAXIMUM DESIGN TAXI WEIGHT

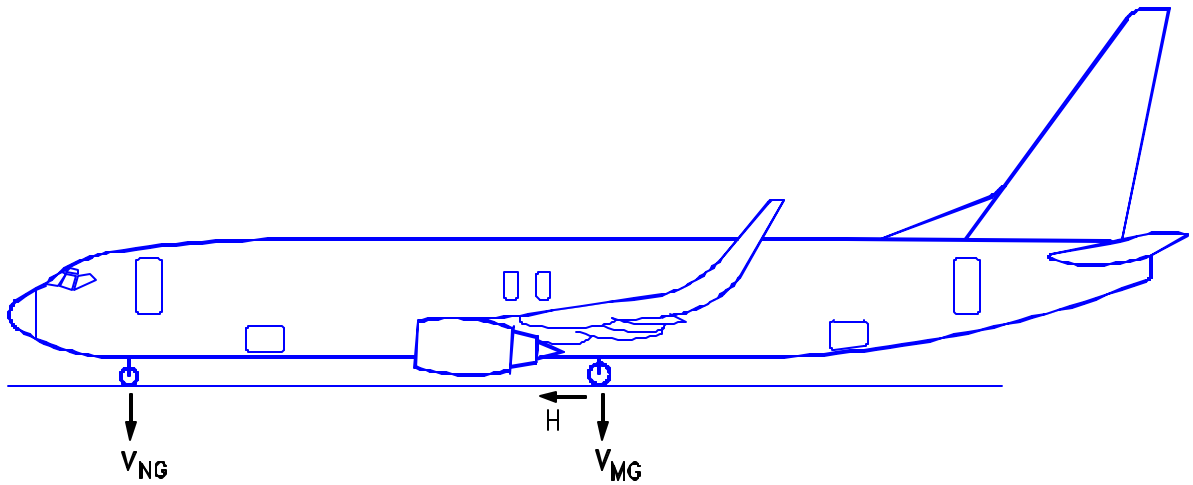

MODEL	UNITS	MAXIMUM DESIGN TAXI WEIGHT	V_{NG}		V_{MG} PER STRUT AT MAX LOAD AT STATIC AFT C.G.	H PER STRUT	
			STATIC AT MOST FWD C.G.	STATIC + BRAKING 10 FT/SEC ² DECEL		STEADY BRAKING 10 FT/SEC ² DECEL	AT INSTANTANEOUS BRAKING ($\mu=0.8$)
737 BBJ	LB	171,500	17,400	29,400	78,700	26,600	62,900
	KG	77,800	7,900	13,340	35,700	12,100	28,550
737 BBJ2	LB	174,700	15,100	24,900	81,700	27,100	65,400
	KG	79,250	6,850	11,300	37,050	12,300	29,650

7.3.4 MAXIMUM PAVEMENT LOADS

MODEL 737 BBJ, 737 BBJ2

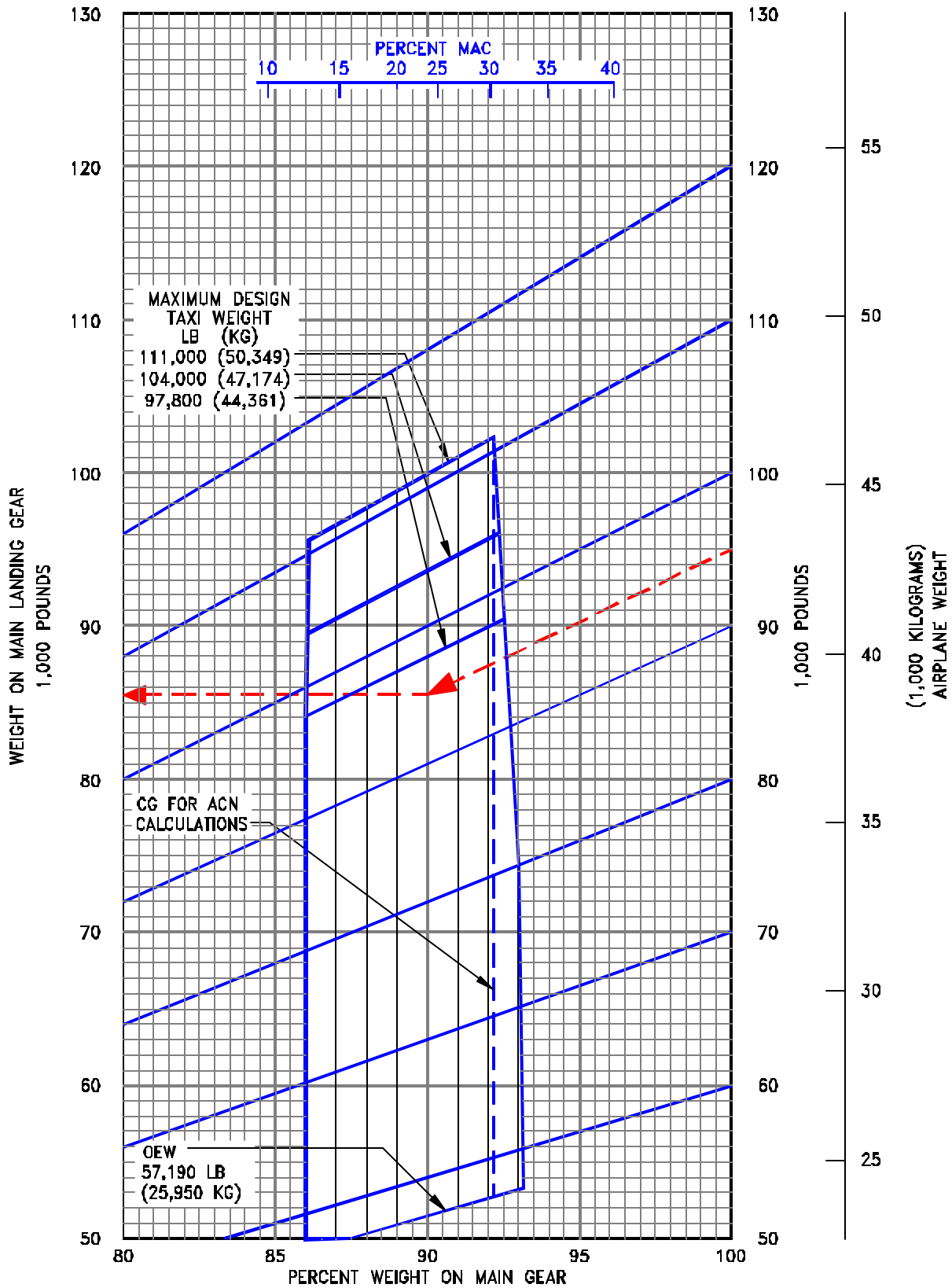

7.4.1 LANDING GEAR LOADING ON PAVEMENT
MODEL 737-100

D6-58325-6

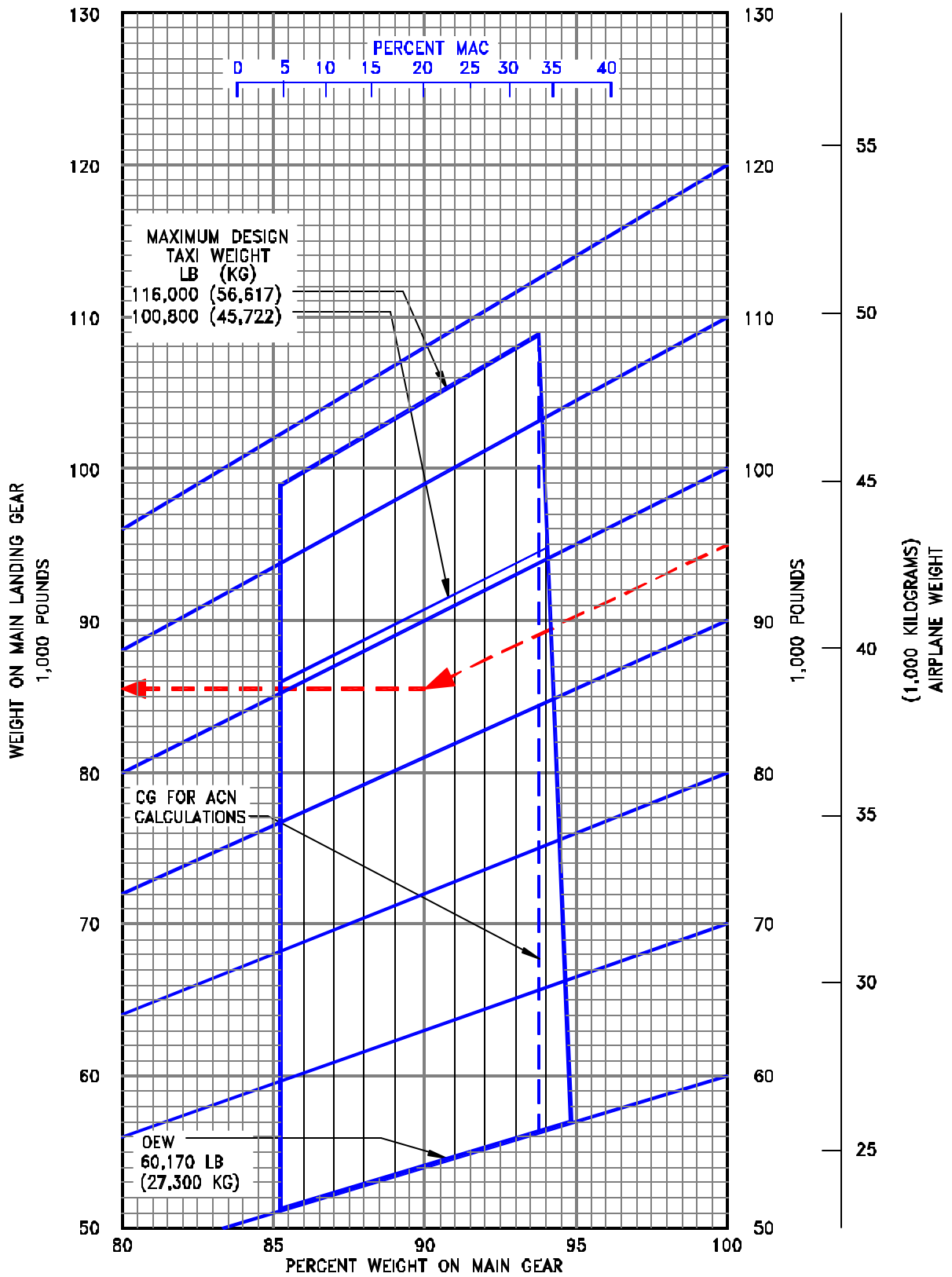

7.4.2 LANDING GEAR LOADING ON PAVEMENT
MODEL 737-200

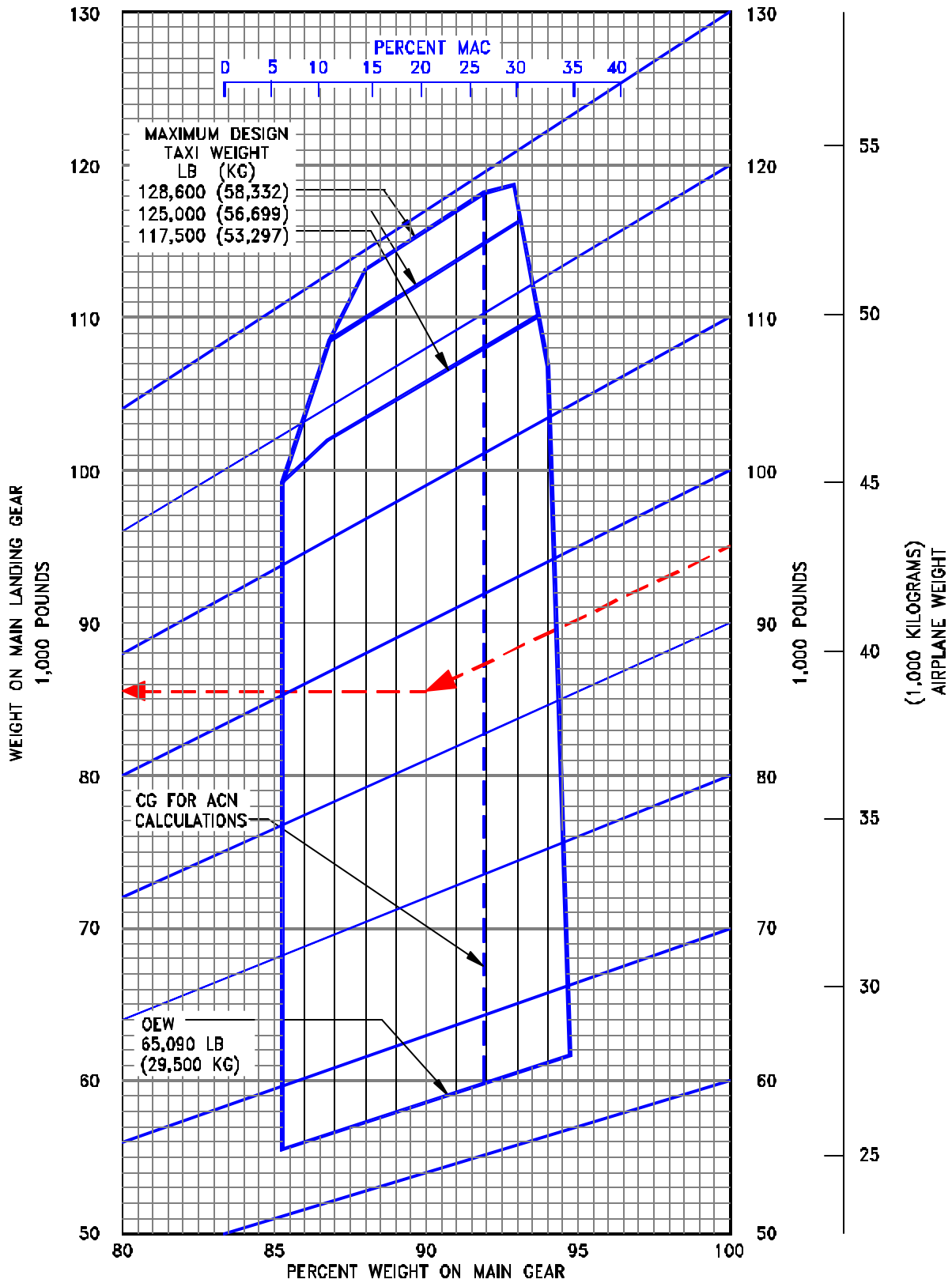

7.4.3 LANDING GEAR LOADING ON PAVEMENT
MODEL 737-200 ADVANCED

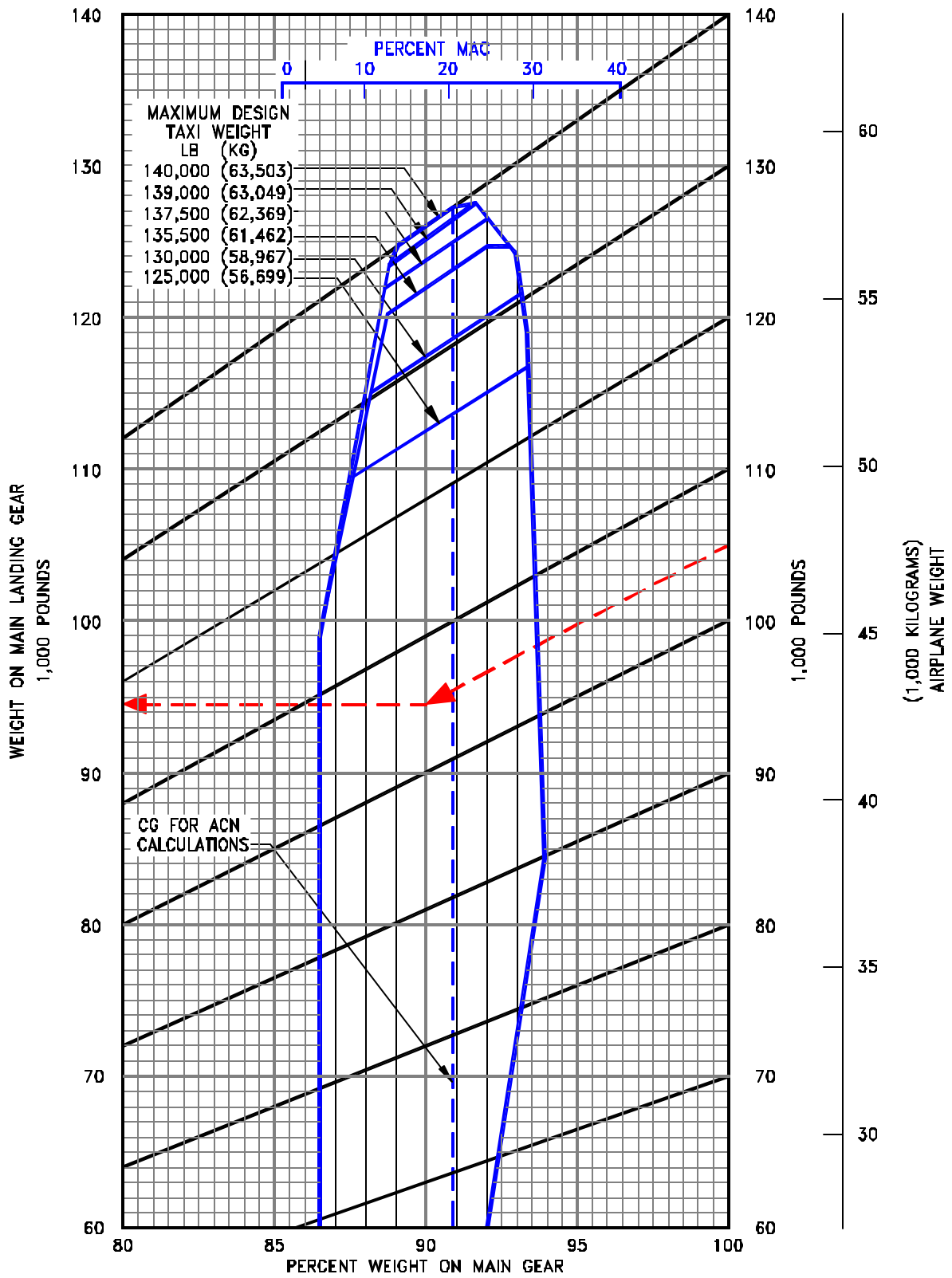

7.4.4 LANDING GEAR LOADING ON PAVEMENT
MODEL 737-300

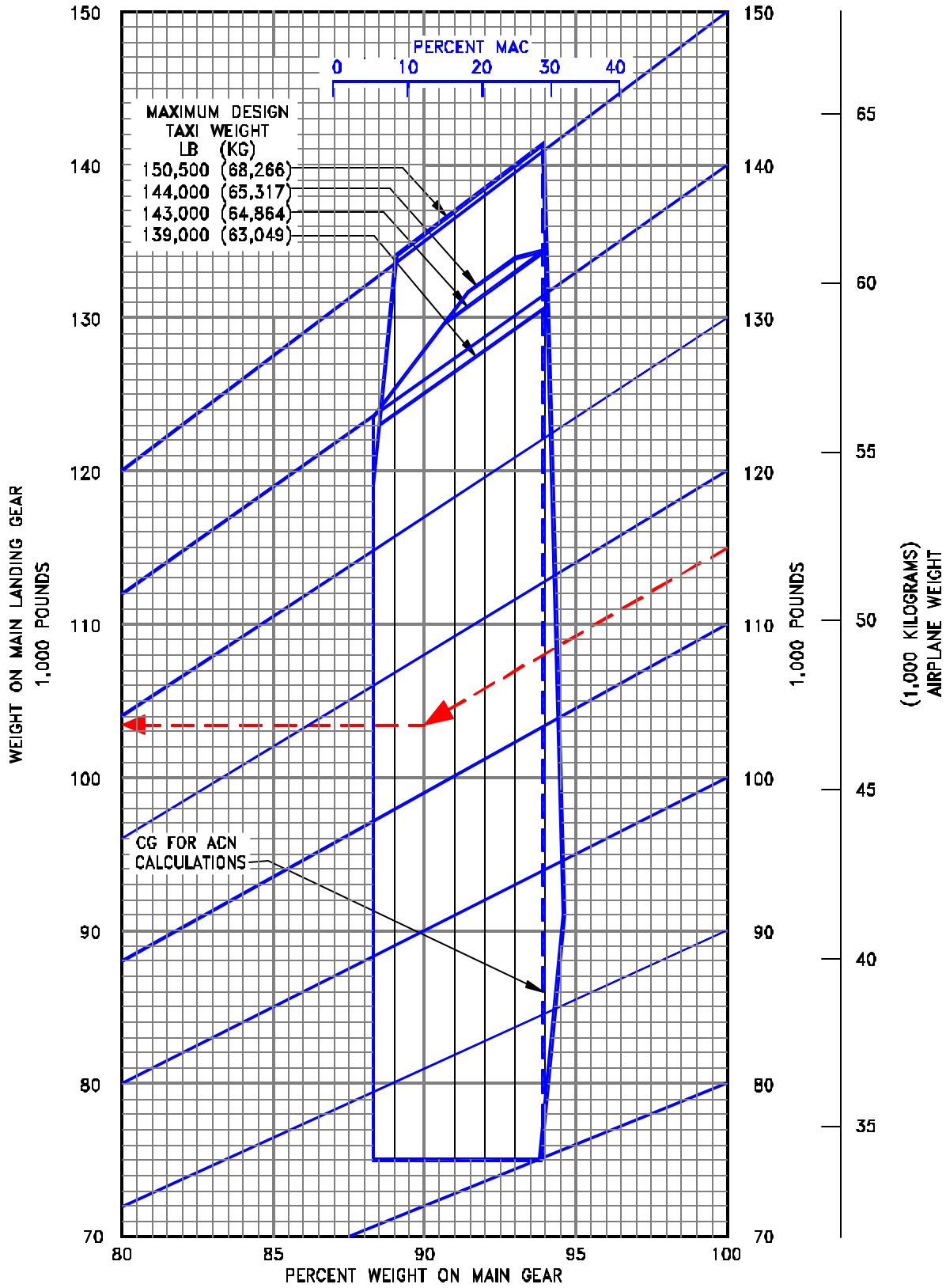

7.4.5 LANDING GEAR LOADING ON PAVEMENT
MODEL 737-400

D6-58325-6

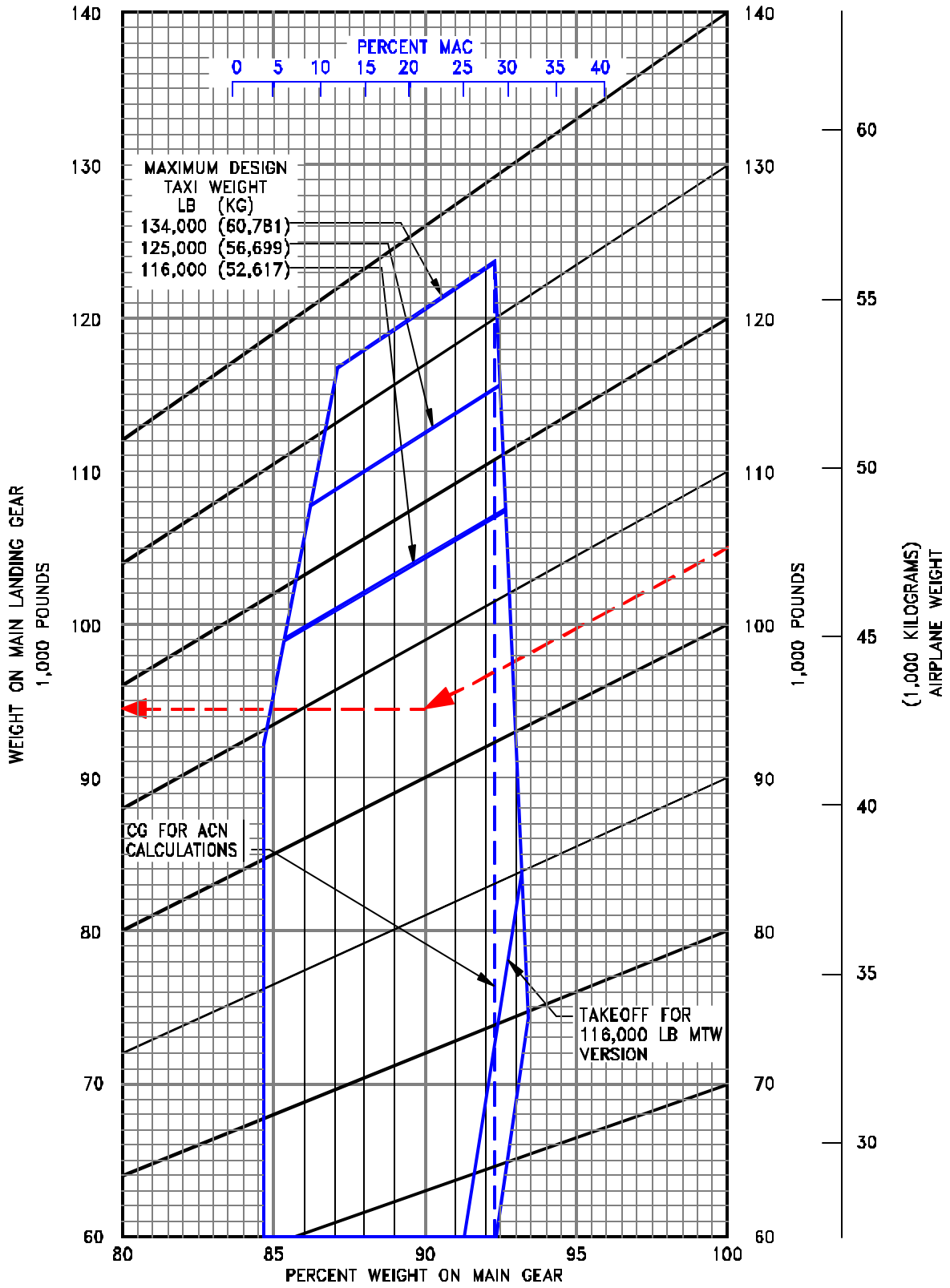

7.4.6 LANDING GEAR LOADING ON PAVEMENT
MODEL 737-500

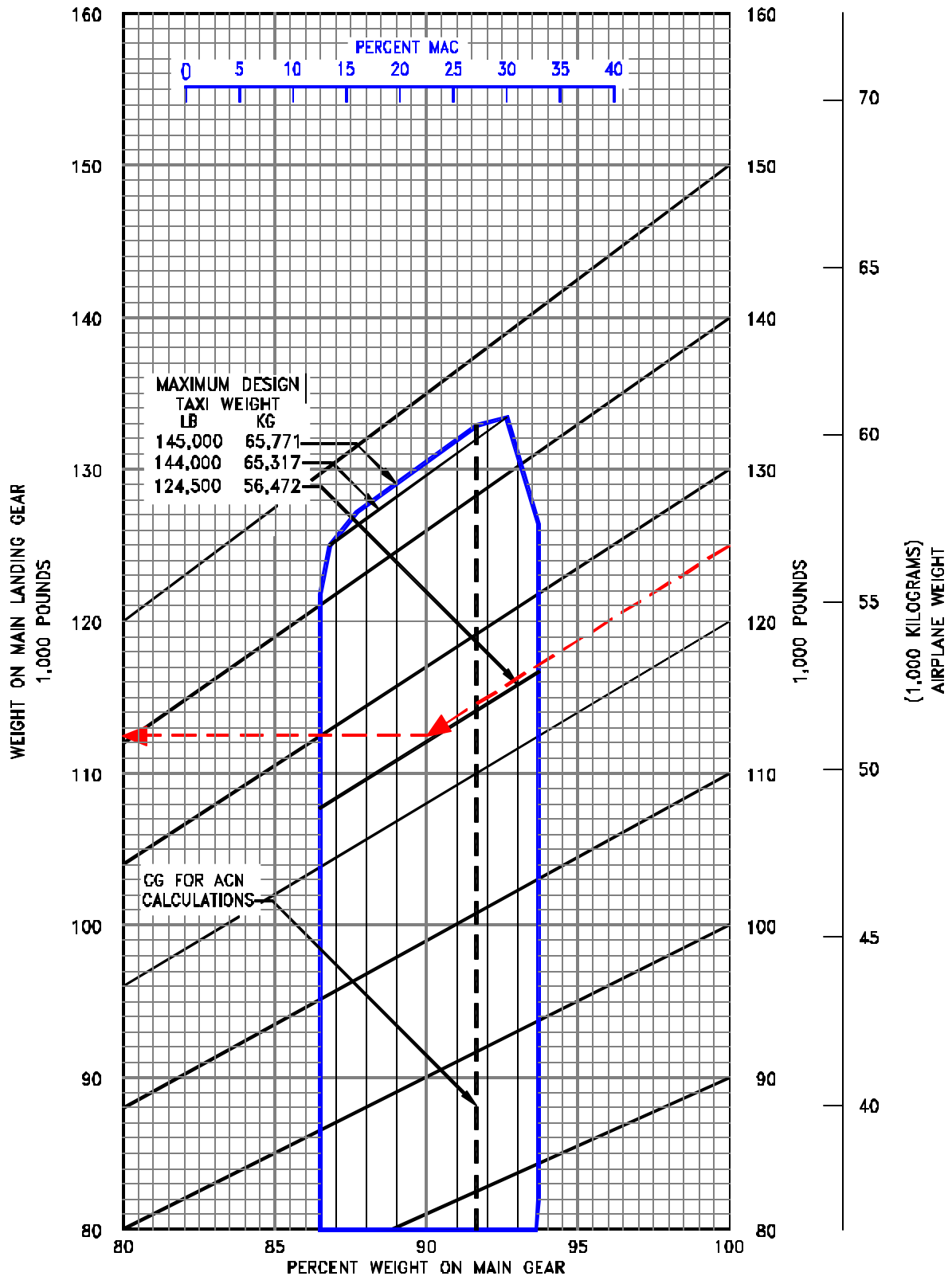

7.4.7 LANDING GEAR LOADING ON PAVEMENT
MODEL 737-600

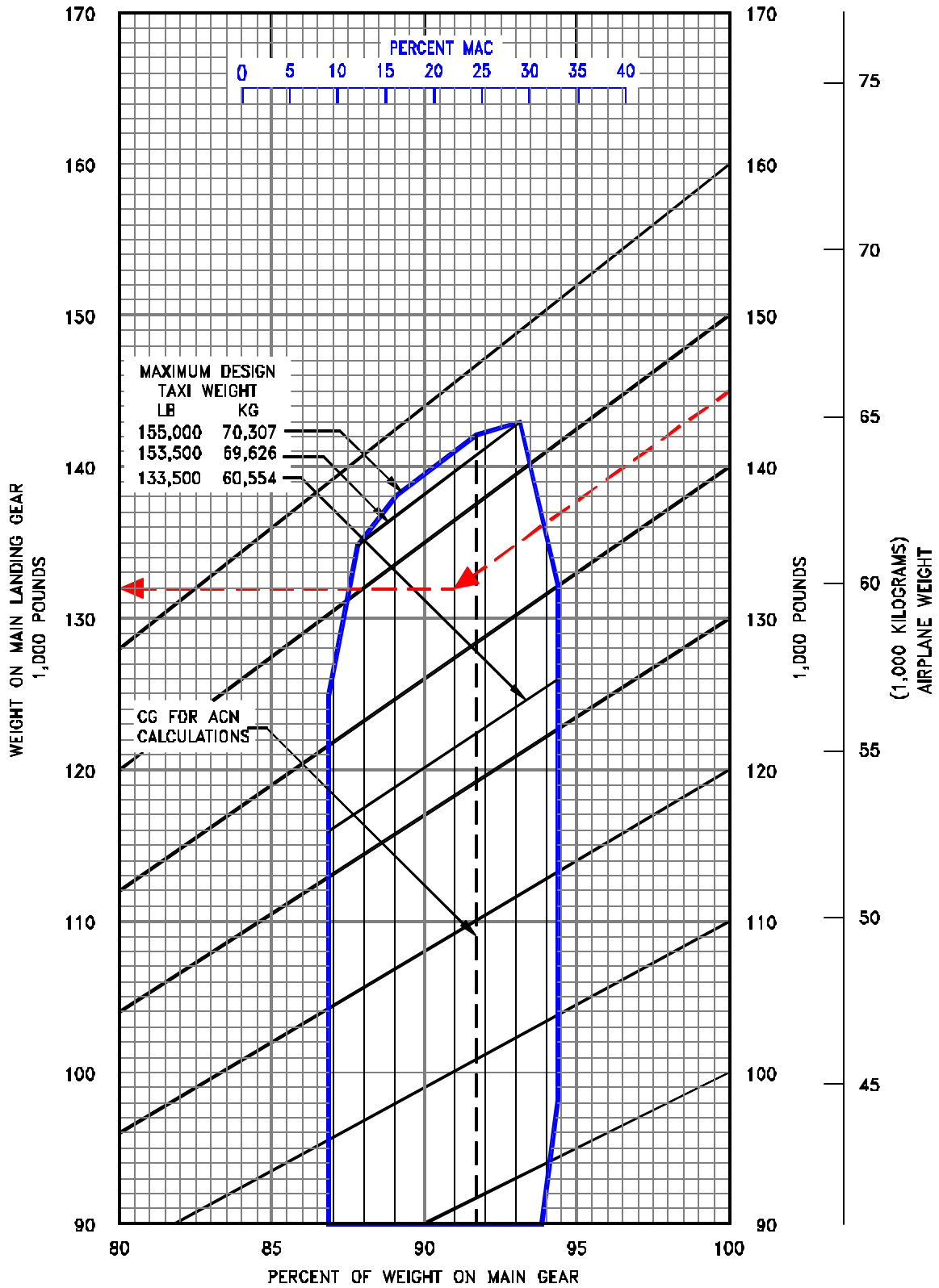

7.4.8 LANDING GEAR LOADING ON PAVEMENT
MODEL 737-700, -700 WITH WINGLETS

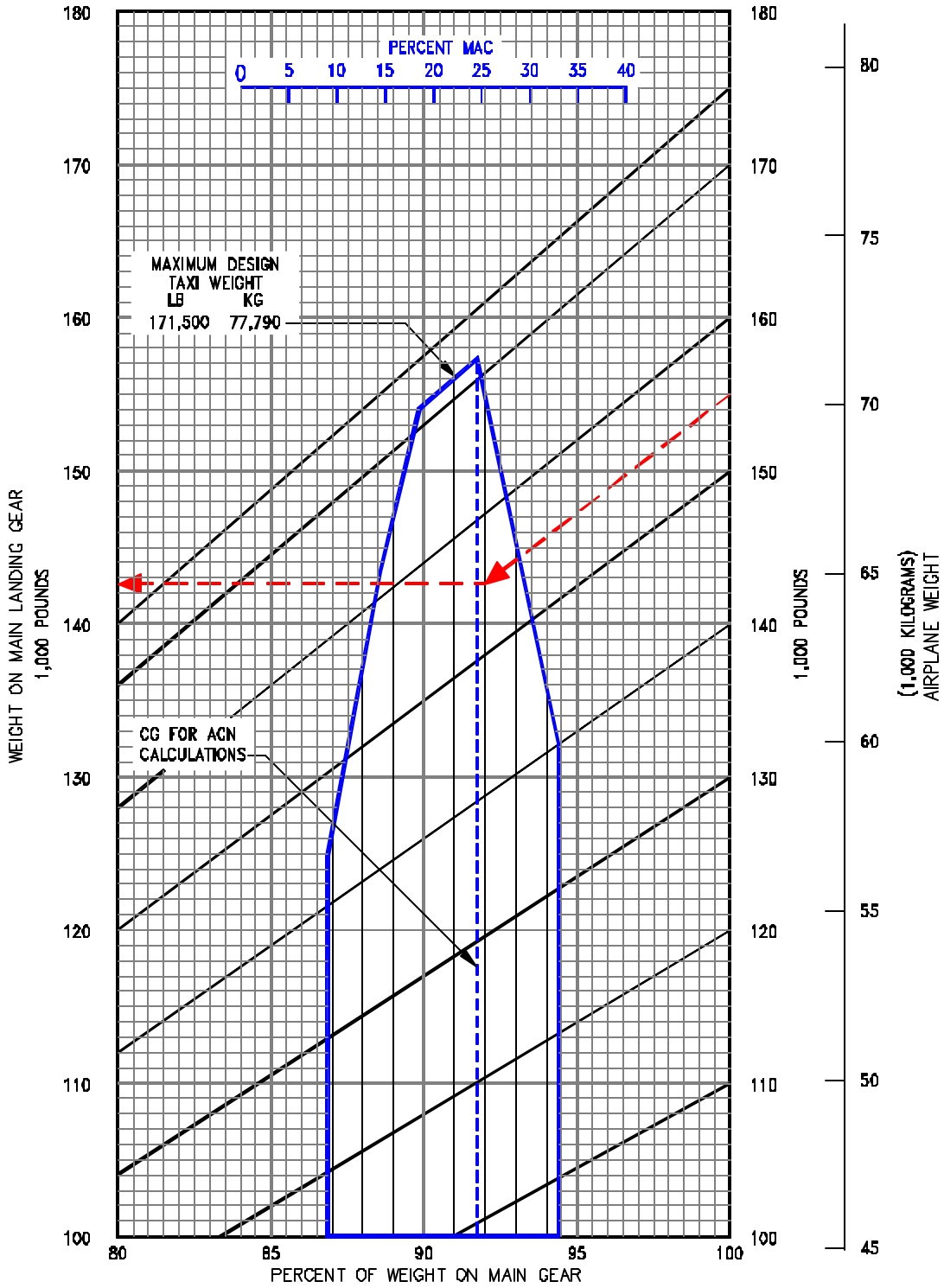

7.4.9 LANDING GEAR LOADING ON PAVEMENT
MODEL 737 BBJ

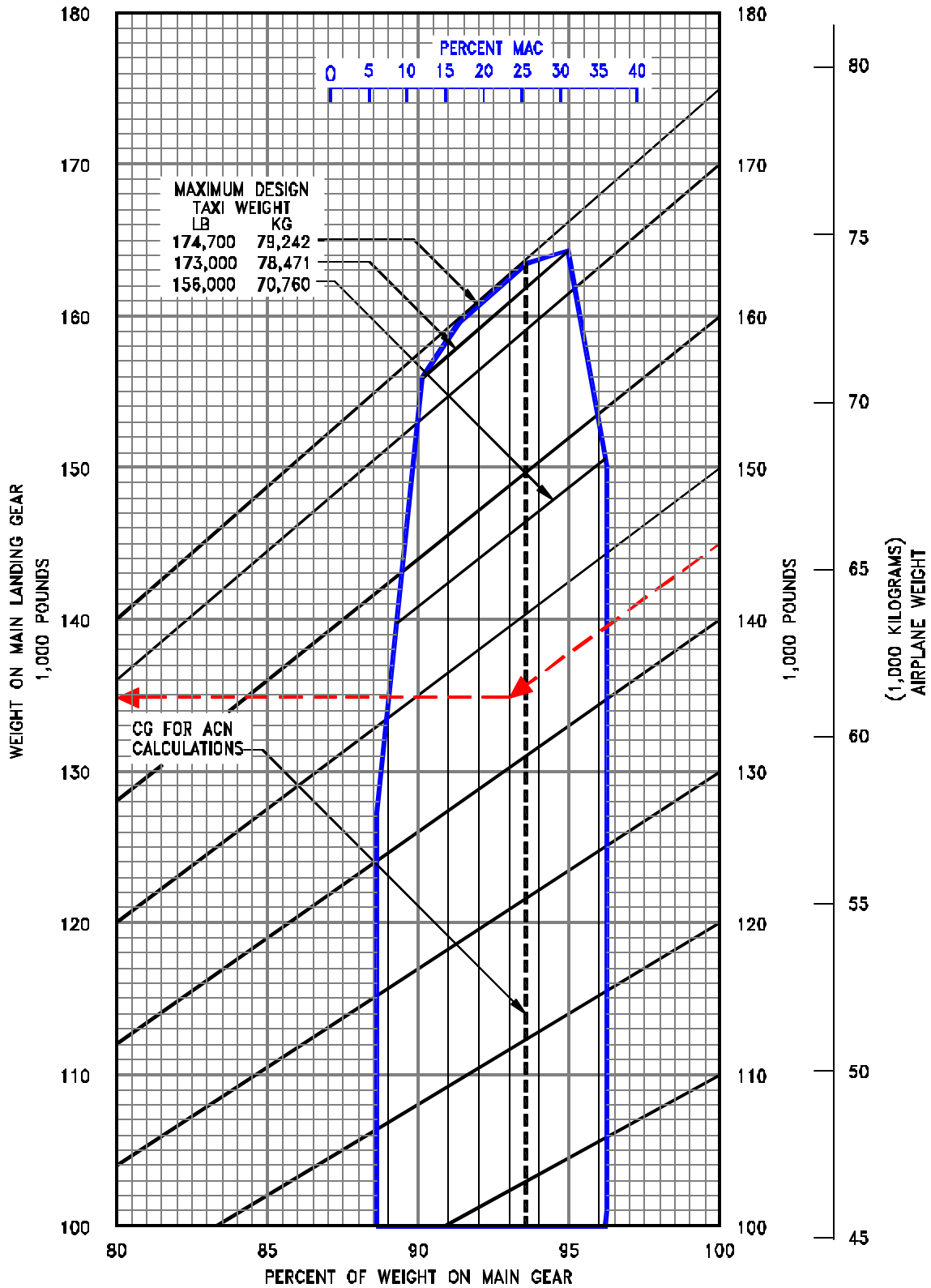

7.4.10 LANDING GEAR LOADING ON PAVEMENT
MODEL 737-800, -800 WITH WINGLETS

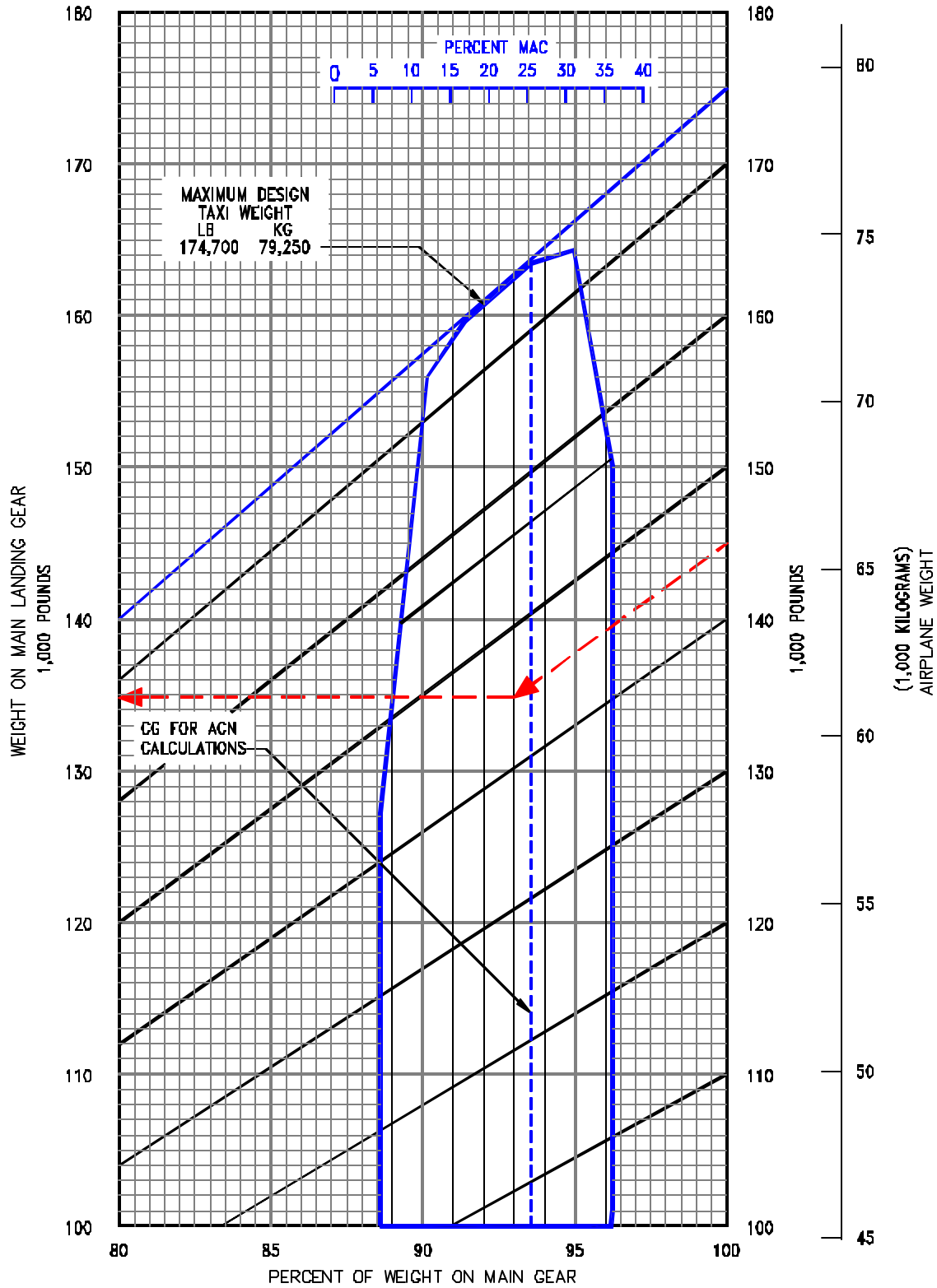

7.4.11 LANDING GEAR LOADING ON PAVEMENT
MODEL 737 BBJ2

D6-58325-6

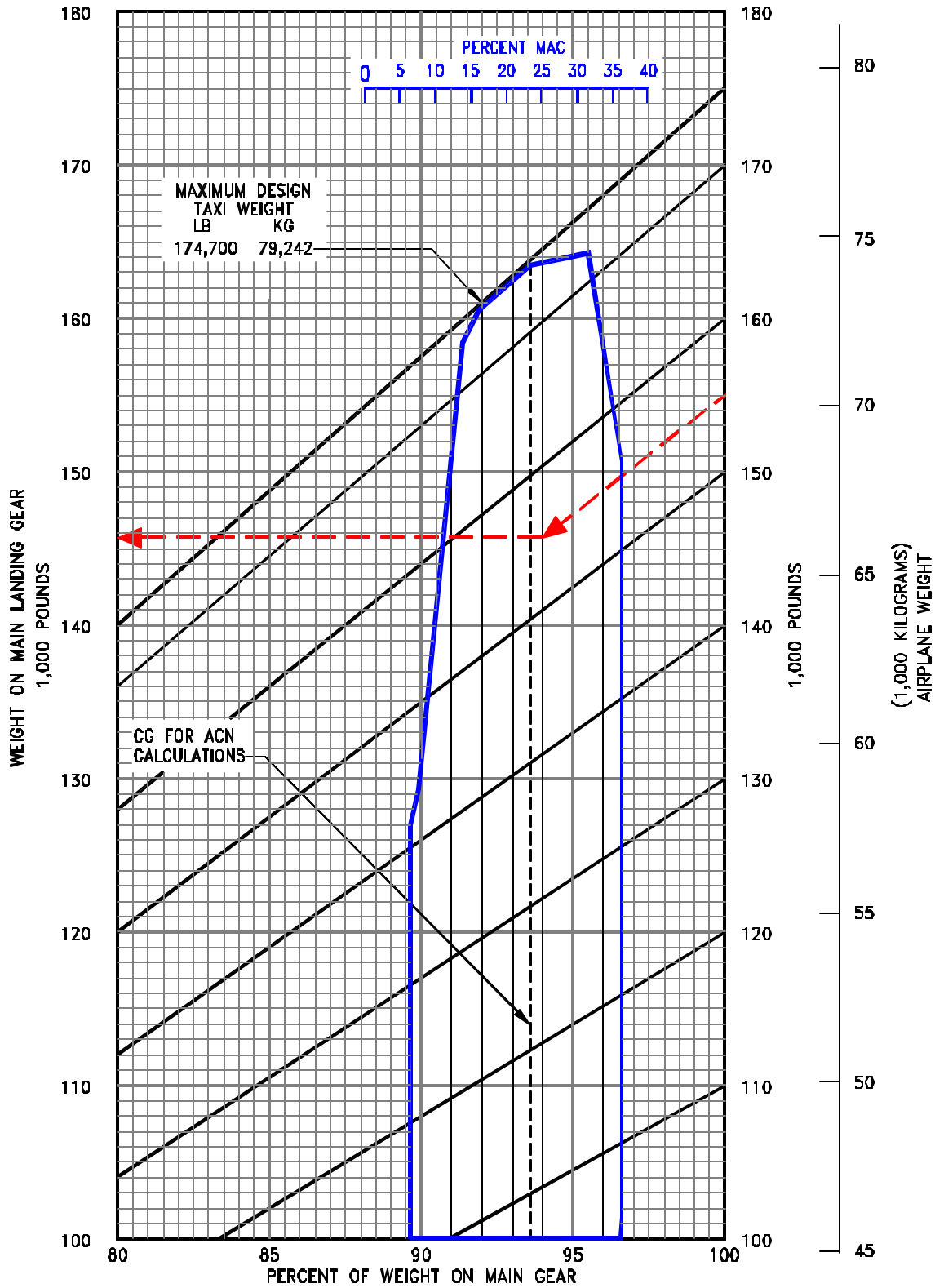

7.4.12 LANDING GEAR LOADING ON PAVEMENT
 MODEL 737-900, -900 WITH WINGLETS

D6-58325-6

PRELIMINARY INFORMATION

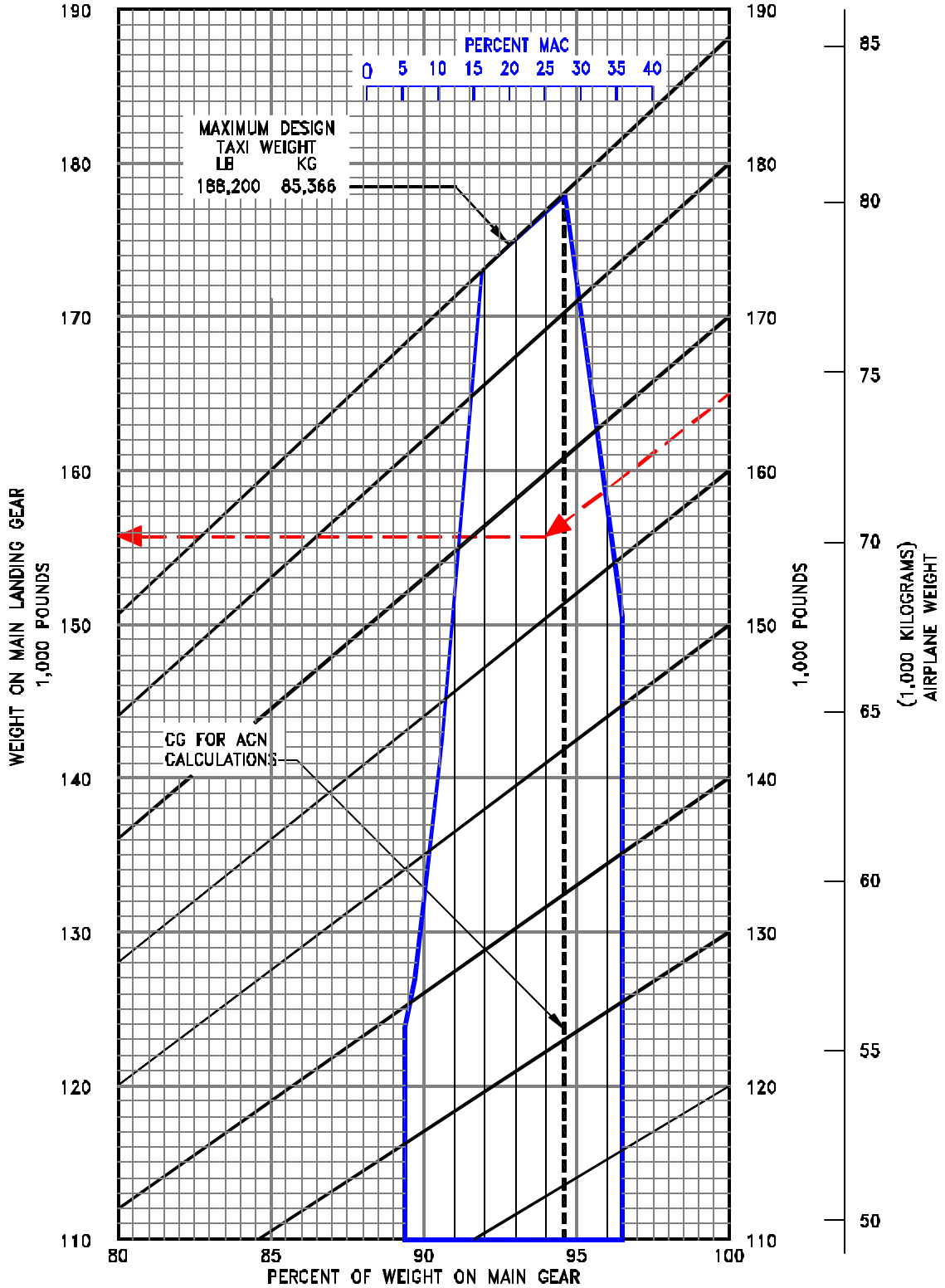

7.4.13 LANDING GEAR LOADING ON PAVEMENT MODEL 737-900ER, -900ER WITH WINGLETS

D6-58325-6

7.5 Flexible Pavement Requirements - U.S. Army Corps of Engineers Method (S-77-1) and FAA Design Method

The following flexible-pavement design chart presents the data of five incremental main-gear loads at the minimum tire pressure required at the maximum design taxi weight.

In the example shown in the next page, for a CBR of 25 and an annual departure level of 10,000, the required flexible pavement thickness for an airplane with a main gear loading of 85,000 pounds is 8.2 inches. Similar examples are shown in succeeding charts.

The line showing 10,000 coverages is used for ACN calculations (see Section 7.10).

The FAA design method uses a similar procedure using total airplane weight instead of weight on the main landing gears. The equivalent main gear loads for a given airplane weight could be calculated from Section 7.4.

NOTES:

* TIRES - 40 x 14 - 16 28 PR; C40 x 14 - 21 22 PR

* PRESSURE RANGE FROM 138 TO 146 PSI (9.70 TO 10.27 KG/SC CM)

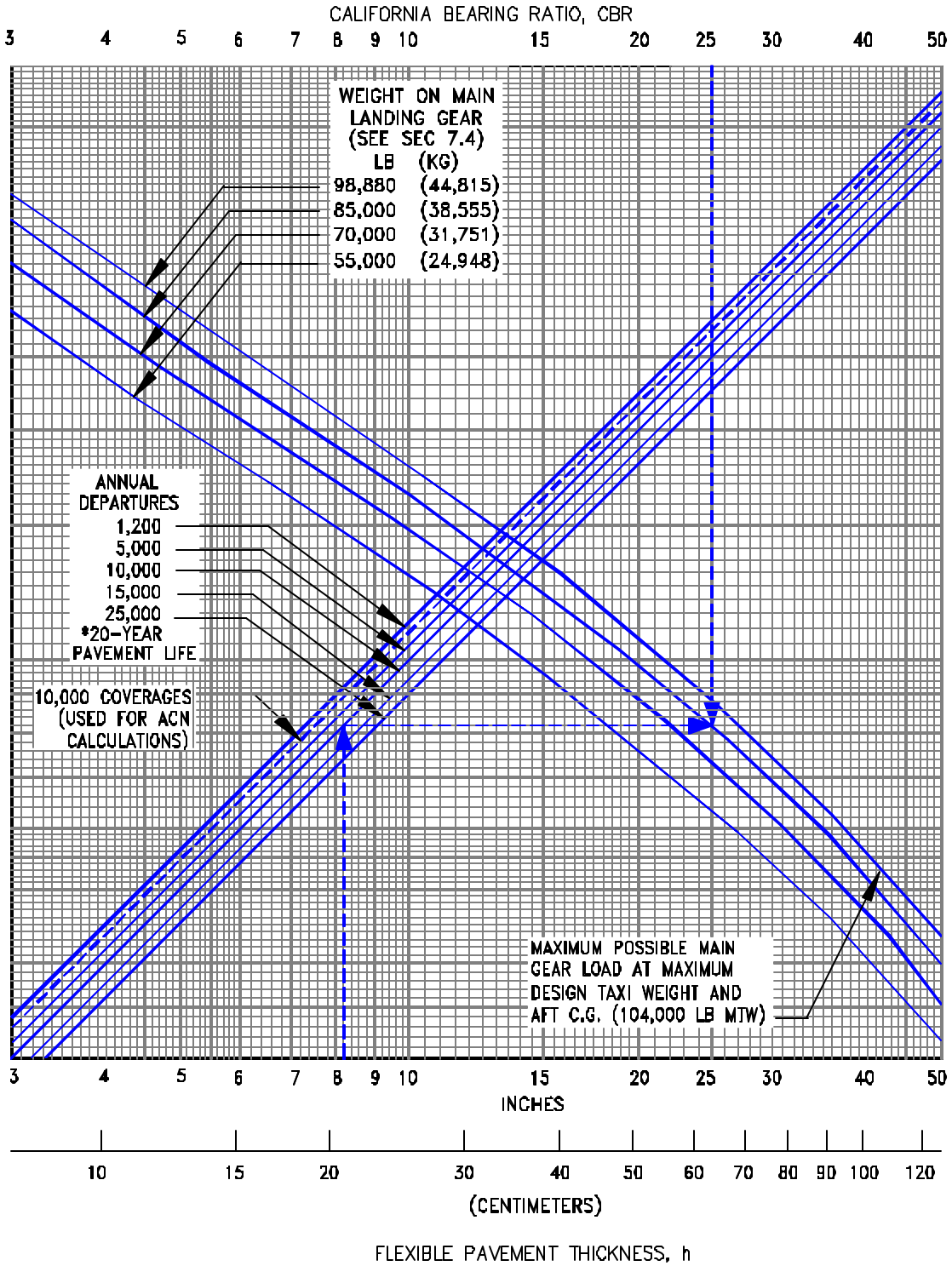

7.5.1 FLEXIBLE PAVEMENT REQUIREMENTS - U.S. ARMY CORPS OF ENGINEERS DESIGN METHOD (S-77-1) AND FAA DESIGN METHOD
 MODEL 737-100, -200 TO 104,000 LB (47,170 KG) MTW

D6-58325-6

- NOTES:
 * TIRES - 40 x 14 - 16 24 PR; C40 x 14 - 21 24 PR
 * PRESSURE RANGE FROM 156 TO 168 PSI (10.97 TO 11.81 KG/SC CM)

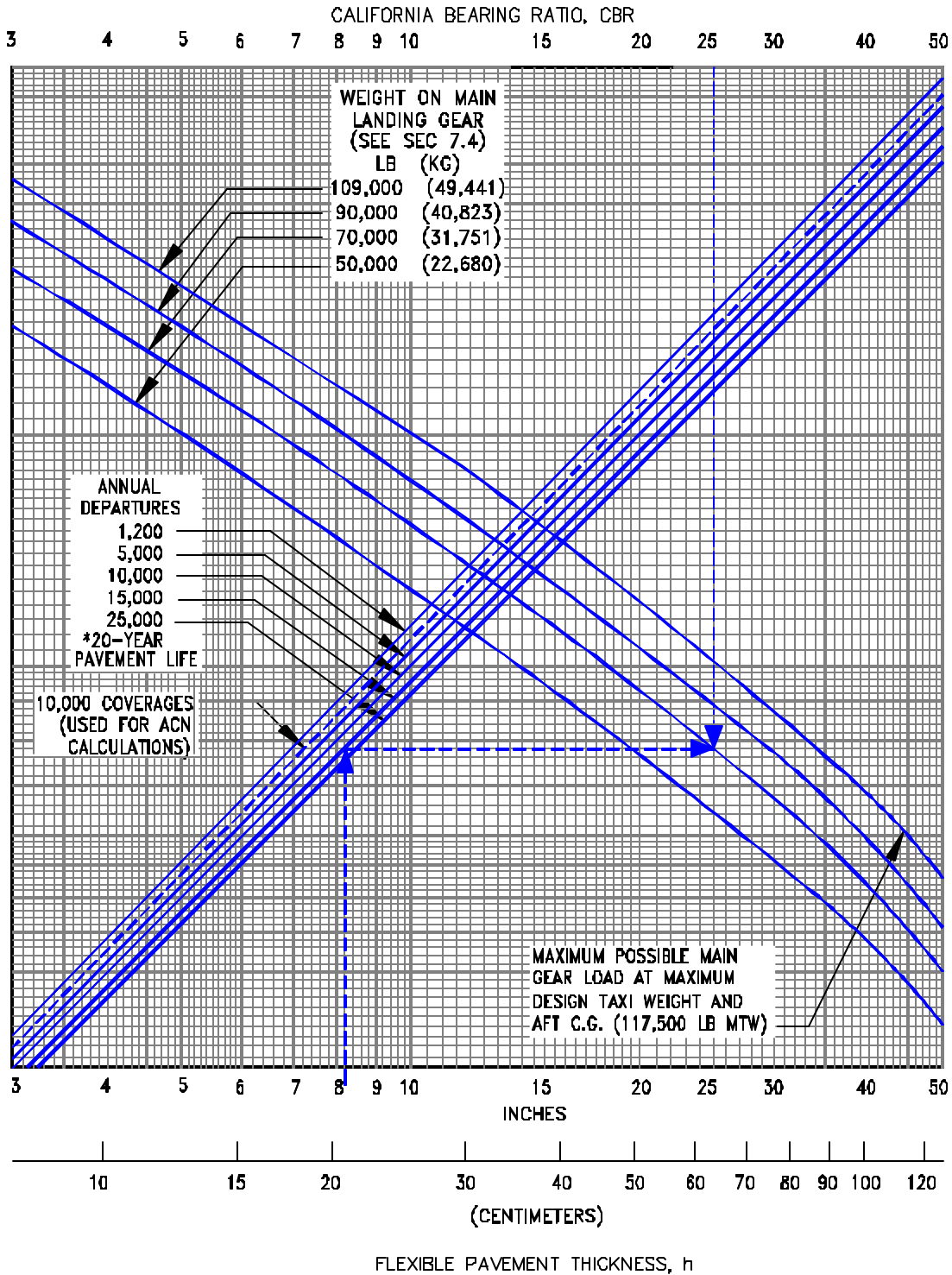

7.5.2 FLEXIBLE PAVEMENT REQUIREMENTS - U.S. ARMY CORPS OF ENGINEERS DESIGN METHOD (S-77-1) AND FAA DESIGN METHOD
 MODEL 737-100, -200, -200 ADV AT 110,000 TO 117,500 LB (49,895 TO 53,297 KG) MTW

NOTES:

* TIRES - C40 x 18 - 17 20 PR

* PRESSURE RANGE AT 95 OR 96 PSI (6.68 OR 6.75 KG/SC CM)

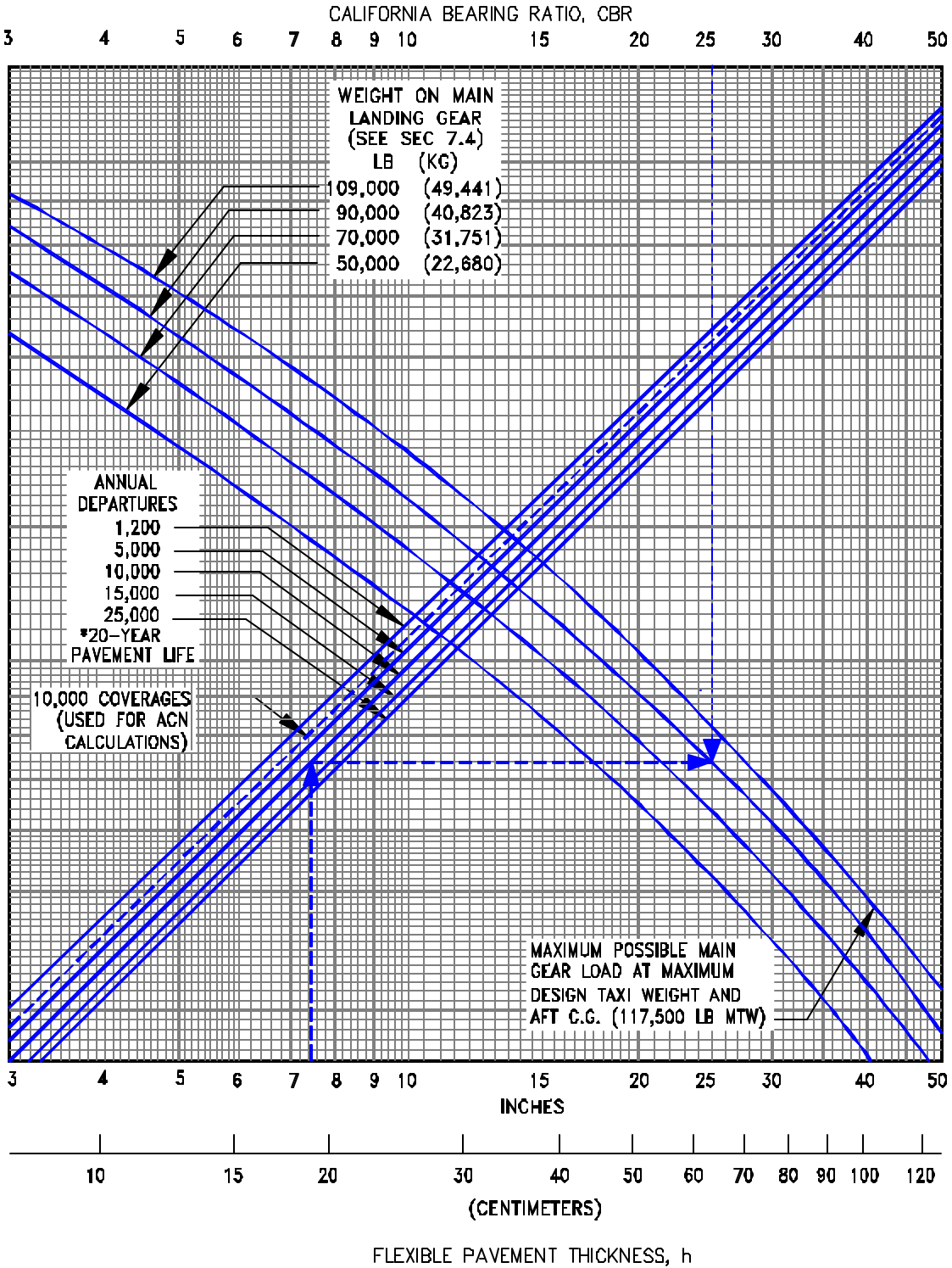

7.5.3 FLEXIBLE PAVEMENT REQUIREMENTS - U.S. ARMY CORPS OF ENGINEERS DESIGN METHOD (S-77-1) AND FAA DESIGN METHOD

MODEL 737-200 ADV AT 116,000 TO 117,500 LB (52,617 TO 53,297 KG) MTW, LOW PRESSURE TIRES

D6-58325-6

- NOTES:
 * TIRES - C40 x 18 - 17 20 PR
 * PRESSURE RANGE AT 95 OR 96 PSI (6.68 OR 6.75 KG/SC CM)

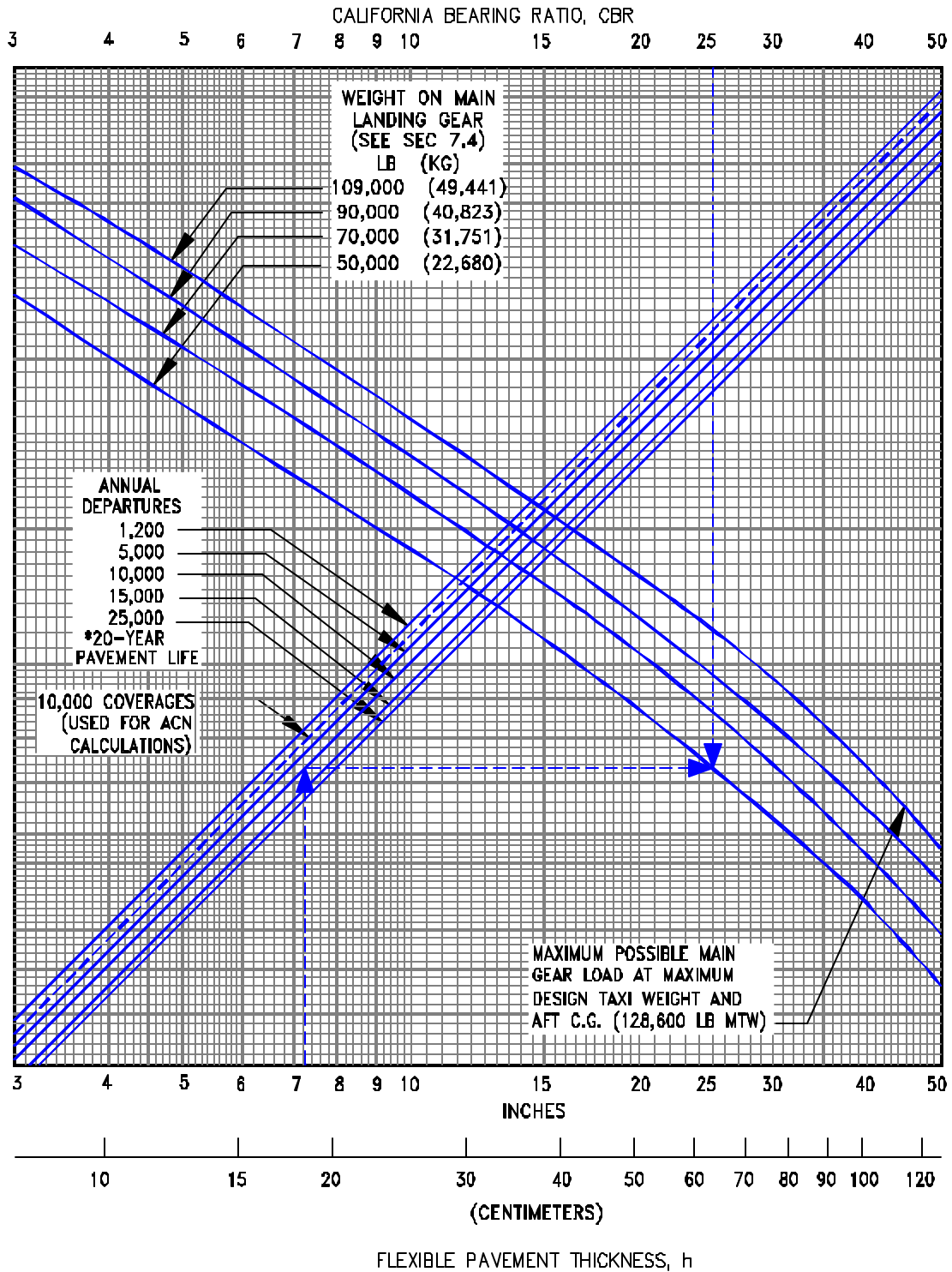

7.5.4 FLEXIBLE PAVEMENT REQUIREMENTS - U.S. ARMY CORPS OF ENGINEERS DESIGN METHOD (S-77-1) AND FAA DESIGN METHOD

MODEL 737-200 ADV AT 120,000 TO 128,600 LB (54,431 TO 58,332 KG) MTW

NOTE:

* TIRES - H40 x 14.5 - 19 24 PR, 26 PR, H42 x 16-19 24 PR, 26 PR

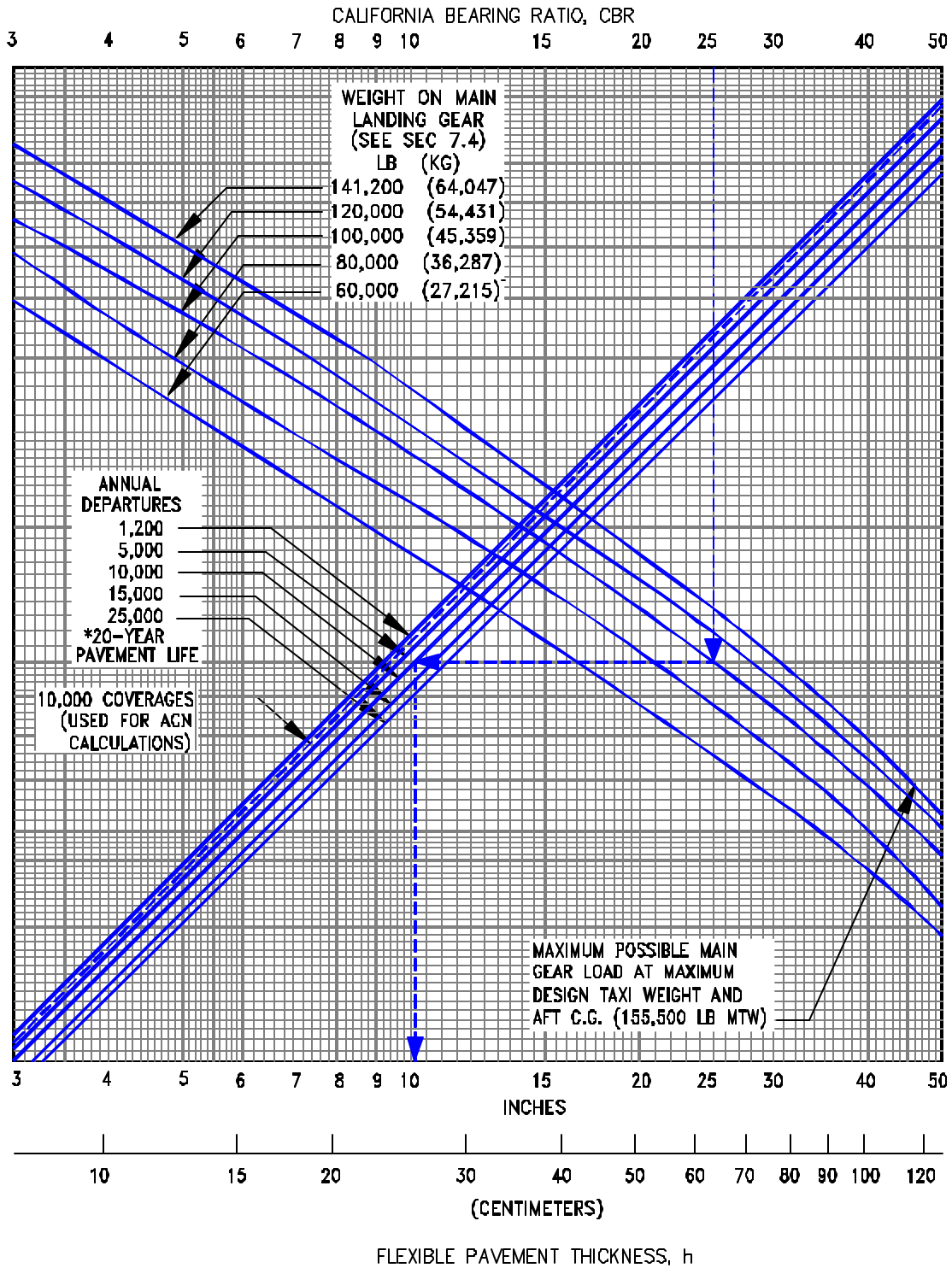

7.5.5 FLEXIBLE PAVEMENT REQUIREMENTS - U.S. ARMY CORPS OF ENGINEERS DESIGN METHOD (S-77-1) AND FAA DESIGN METHOD
MODEL 737-300, -400, -500

NOTE: TIRES - H44.5 x 16.5-21 30 PR

CALIFORNIA BEARING RATIO, CBR

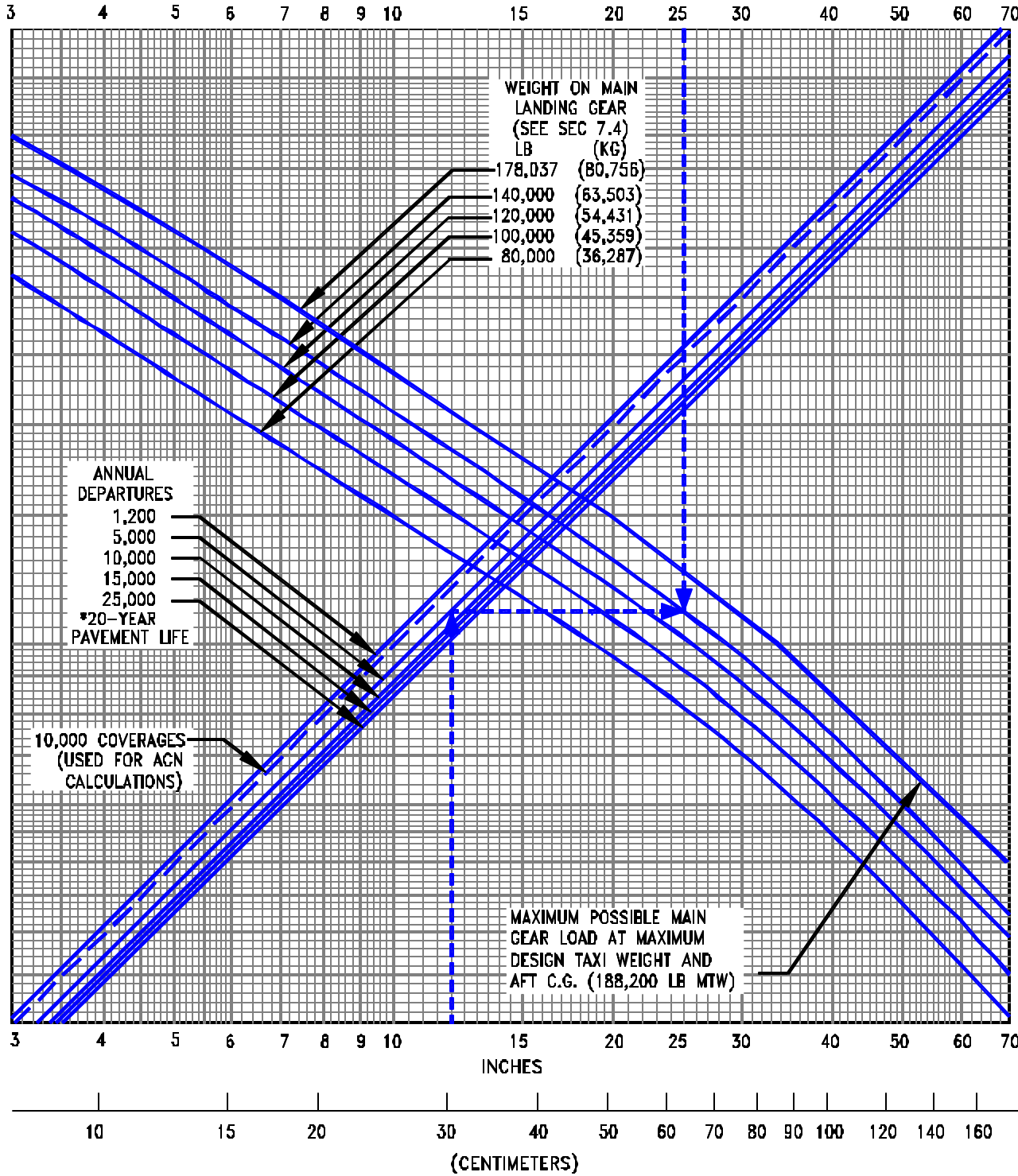

FLEXIBLE PAVEMENT THICKNESS, h

7.5.6 FLEXIBLE PAVEMENT REQUIREMENTS - U.S. ARMY CORPS OF ENGINEERS DESIGN METHOD (S-77-1) AND FAA DESIGN METHOD
 MODEL 737-600, -700, -800, -900, -900ER WITH AND WITHOUT WINGLETS, 737 BBJ, 737 BBJ2

7.6 Flexible Pavement Requirements - LCN Method

To determine the airplane weight that can be accommodated on a particular flexible pavement, both the Load Classification Number (LCN) of the pavement and the thickness must be known.

In the example shown on the next page, flexible pavement thickness is shown at 23.75 in. with an LCN of 42. For these conditions, the apparent maximum allowable weight permissible on the main landing gear is 85,000 lb for an airplane with 138 to 146-psi main gear tires. Similar examples are shown in succeeding charts.

Note: If the resultant aircraft LCN is not more than 10% above the published pavement LCN, the bearing strength of the pavement can be considered sufficient for unlimited use by the airplane. The figure 10% has been chosen as representing the lowest degree of variation in LCN that is significant (reference: ICAO Aerodrome Manual, Part 2, "Aerodrome Physical Characteristics," Chapter 4, Paragraph 4.1.5.7v, 2nd Edition dated 1965).

- NOTES:
- * TIRES - H40 x 14 - 16 22PR, C40 x 14 - 21 22 PR
 - * TIRE PRESSURE RANGE FROM 138 TO 146 PSI (9.70 TO 10.27 KG/SQ CM)

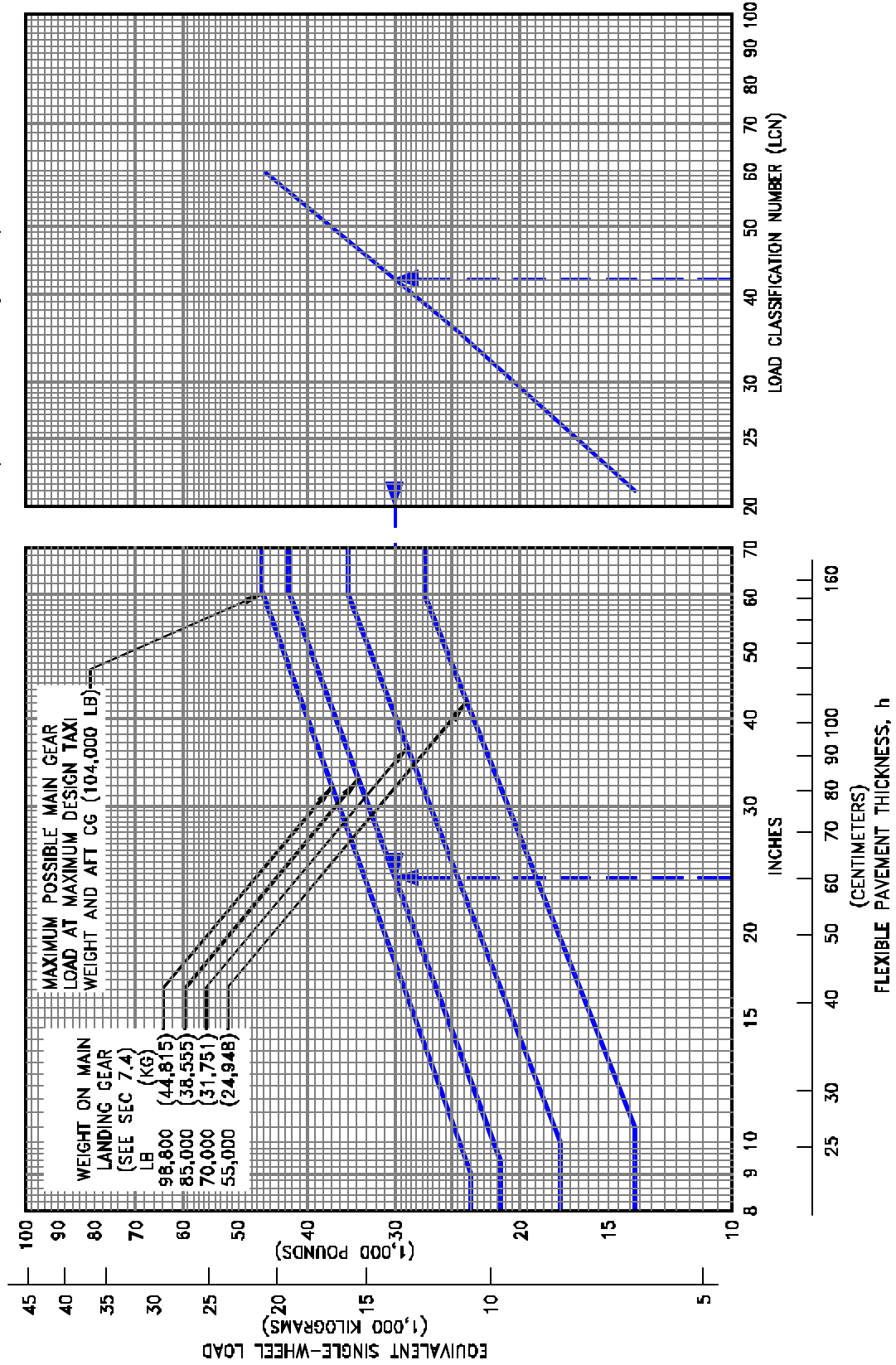

7.6.1 FLEXIBLE PAVEMENT REQUIREMENTS - LCN METHOD
 MODEL 737-100, -200 AT 104,000 LB (47,174 KG) MTW

NOTES:

- * TIRES - H40 x 14 - 16 24PR, C40 x 14 - 21 24 PR
- * TIRE PRESSURE RANGE FROM 156 TO 168 PSI (10.97 TO 11.81 KG/SQ CM)

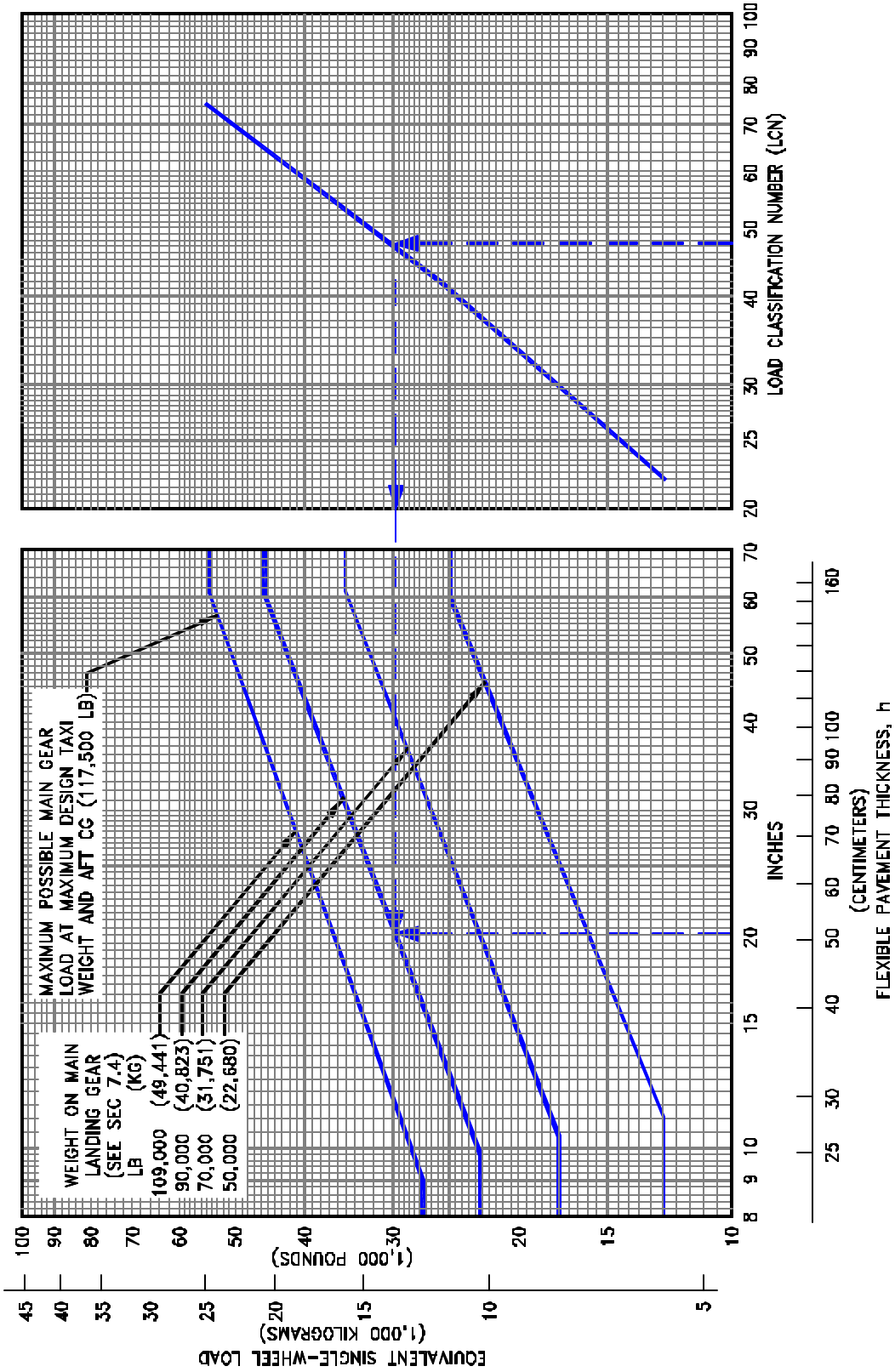

7.6.2 FLEXIBLE PAVEMENT REQUIREMENTS - LCN METHOD

MODEL 737-100, -200, -200 ADV AT 110,000 TO 117,500 LB (49,895 TO 53,297 KG) MTW

NOTES:

- * TIRES - C40 x 18 - 17 20 PR
- * TIRE PRESSURE AT 95 OR 96 PSI (6.68 OR 6.75 KG/SQ CM)

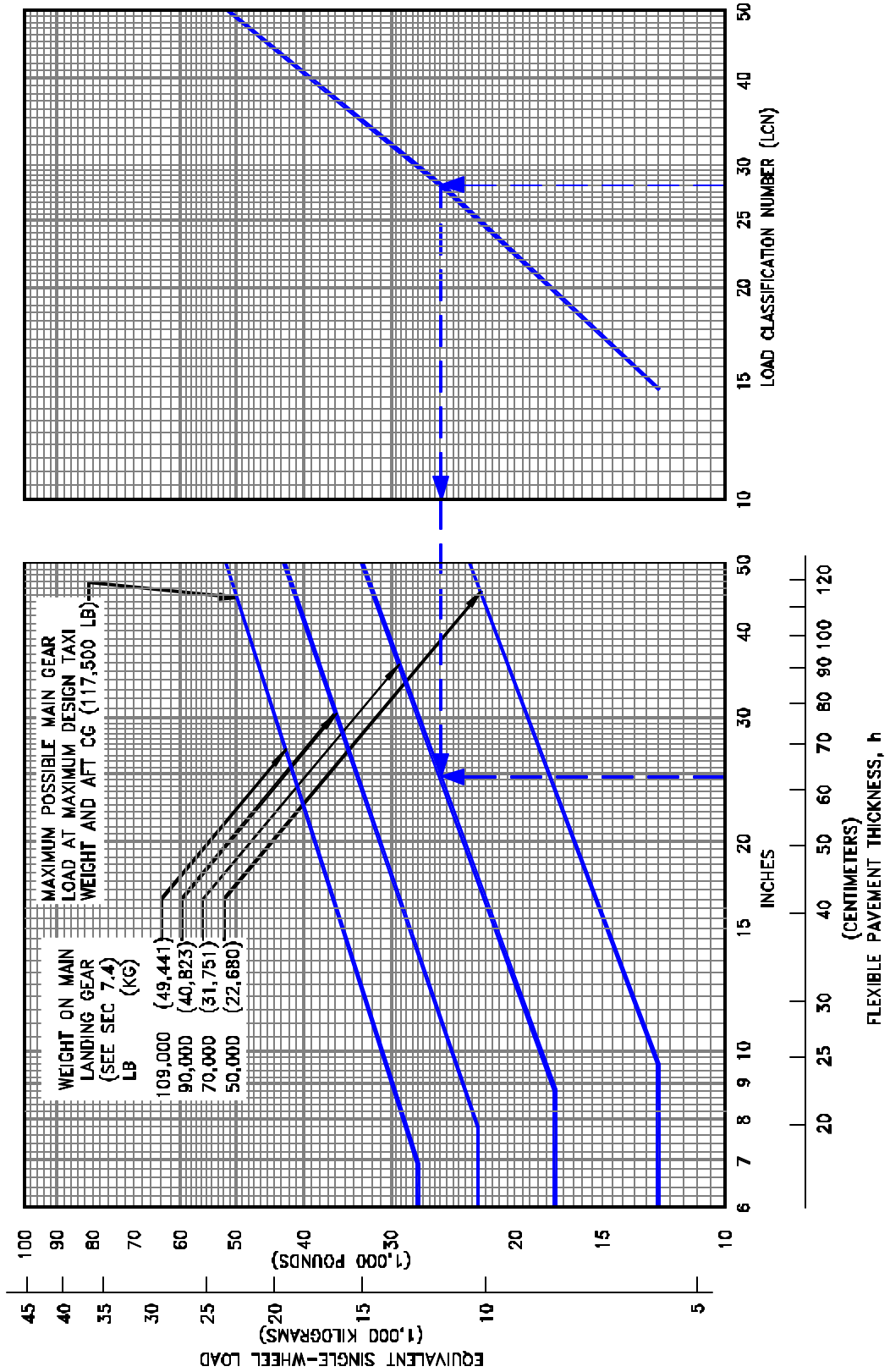

7.6.3 FLEXIBLE PAVEMENT REQUIREMENTS - LCN METHOD

MODEL 737-200 ADV AT 116,000 TO 117,500 LB (52,617 TO 53,297 KG) MTW, LOW PRESSURE TIRES

- NOTES:
- * TIRES - H40 x 14 - 16 24PR, C40 x 14 - 21 24 PR OR 26 PR; H40 x 14.5 - 19 24 PR
 - * TIRE PRESSURE RANGE FROM 170 TO 182 PSI (11.95 TO 12.80 KG/SQ CM)

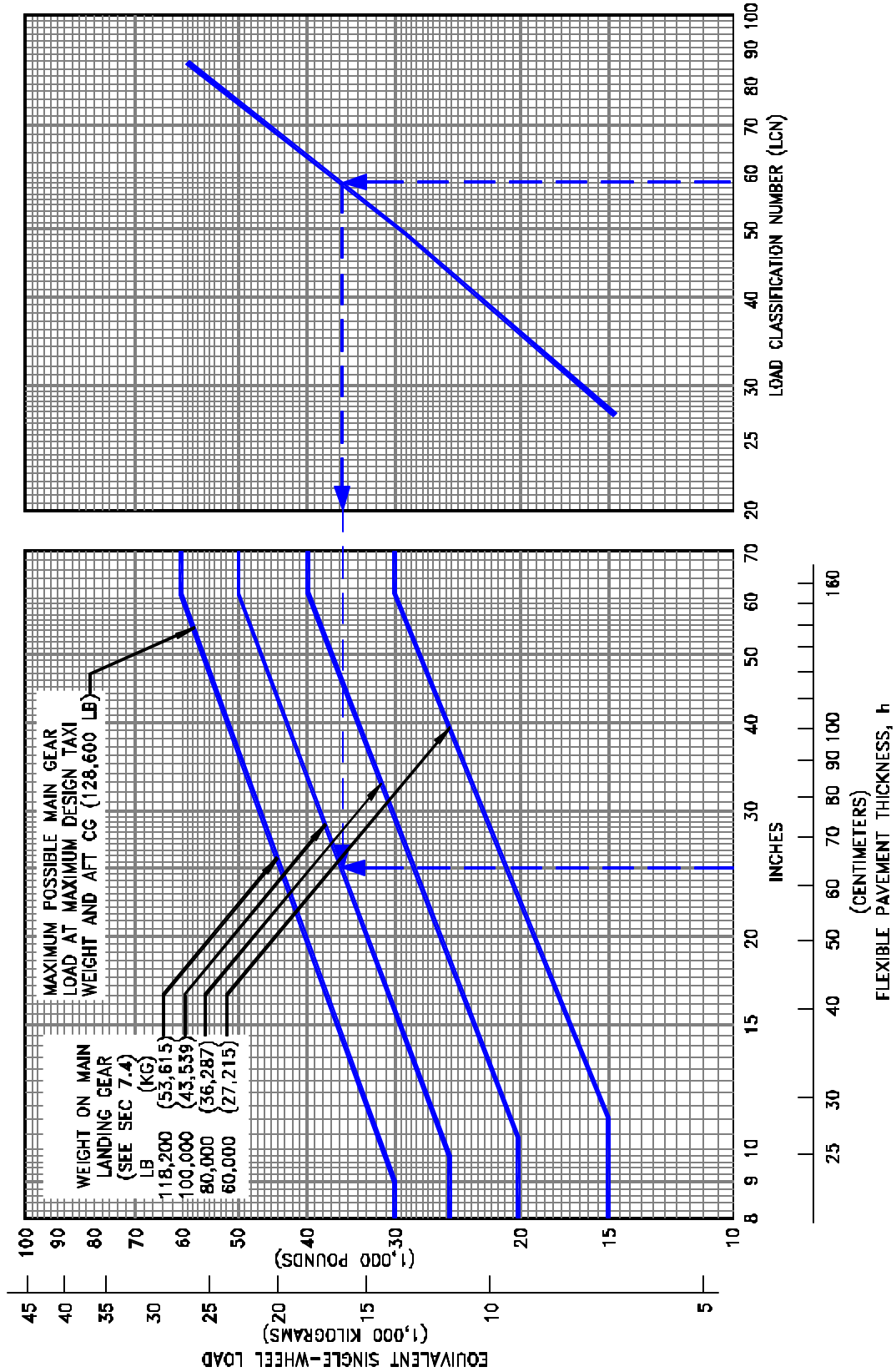

7.6.4 FLEXIBLE PAVEMENT REQUIREMENTS - LCN METHOD

MODEL 737-200 ADV AT 120,000 TO 128,600 LB (54,431 TO 58,332 KG) MTW

D6-58325-6

NOTE: * TIRES - H40 x H40 x 14.5 - 19 24 PR, 26 PR; H42 x 16 - 19 24 PR, 26 PR

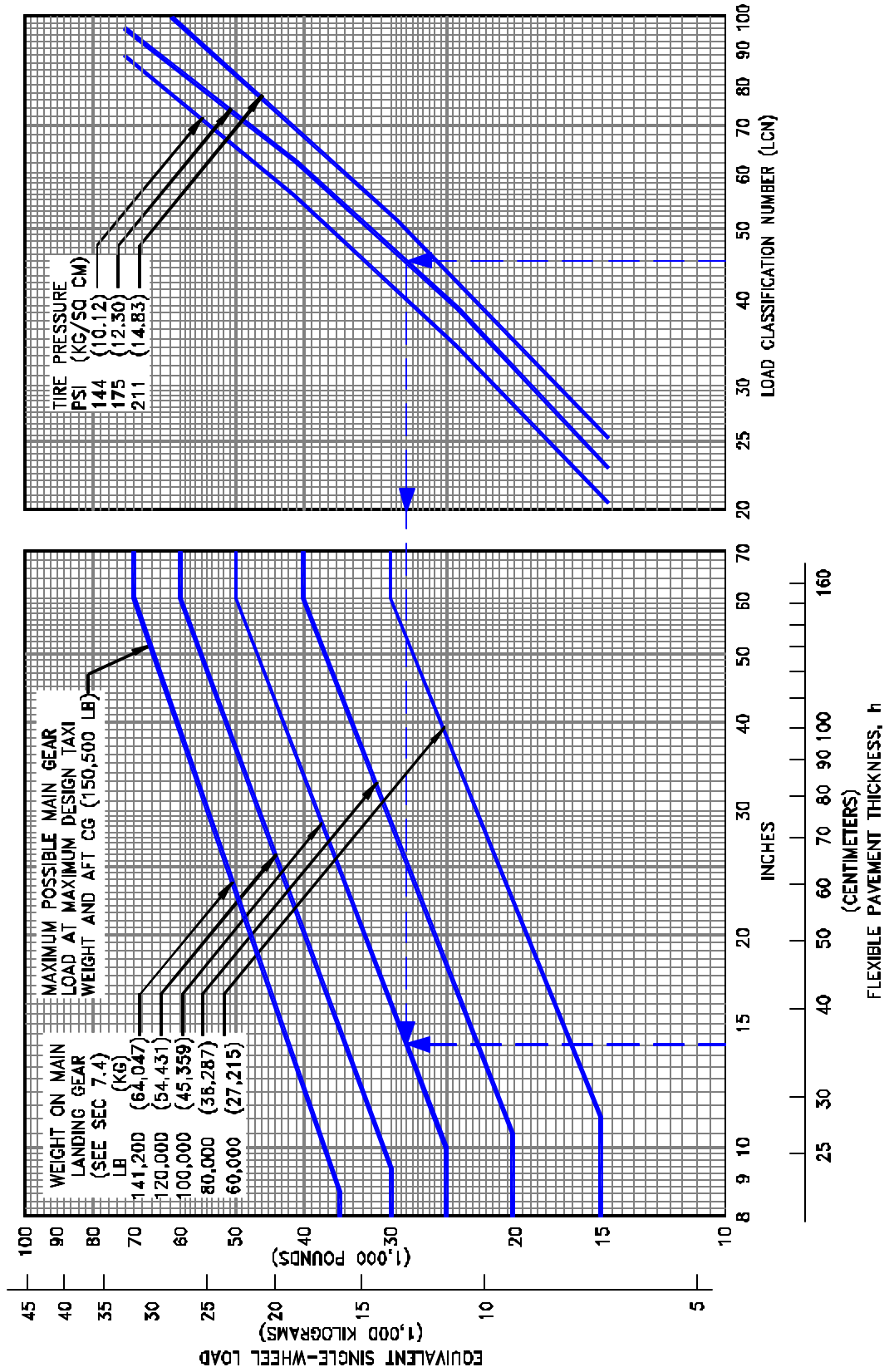

7.6.5 FLEXIBLE PAVEMENT REQUIREMENTS - LCN METHOD
 MODEL 737-300, -400, -500

NOTES:
 * TIRES - H44.5 x 16.5 - 21.30PR, TIRE PRESSURE 220 PSI (15.47 KG/SQ CM)
 * EQUIVALENT SINGLE-WHEEL LOADS ARE DERIVED FROM ICAD AERODROME MANUAL, PART 2 PAR. 4.1.3, DATED 1965.

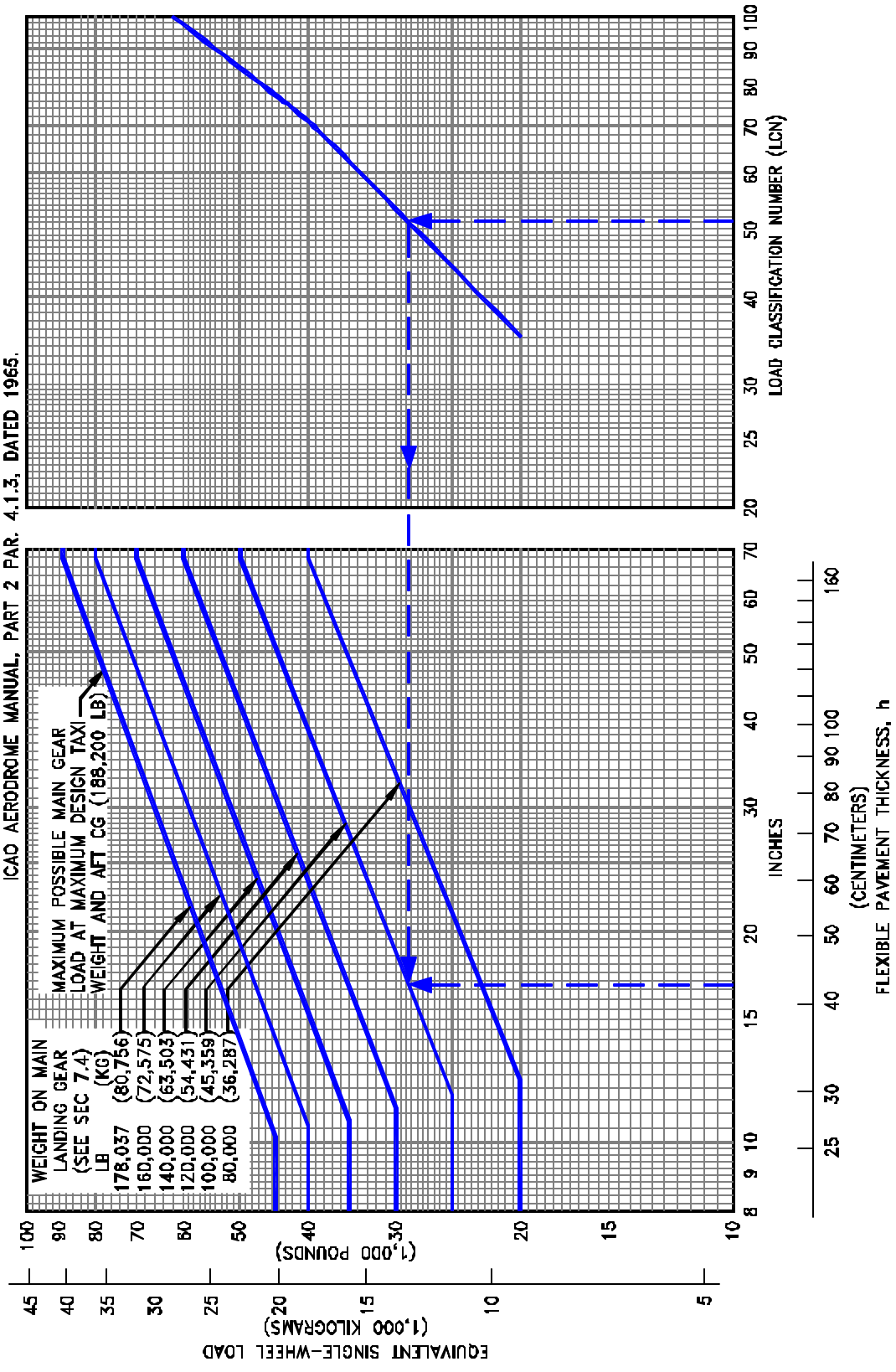

7.6.6 FLEXIBLE PAVEMENT REQUIREMENTS - LCN METHOD

MODEL 737-600, -700, -800, -900, -900ER WITH AND WITHOUT WINGLETS, 737 BBJ, 737 BBJ2

7.7 Rigid Pavement Requirements - Portland Cement Association Design Method

The Portland Cement Association method of calculating rigid pavement requirements is based on the computerized version of "Design of Concrete Airport Pavement" (Portland Cement Association, 1965) as described in XP6705-2, "Computer Program for Airport Pavement Design" by Robert G. Packard, Portland Cement Association, 1968.

The following rigid pavement design chart presents the data for five incremental main gear loads at the minimum tire pressure required at the maximum design taxi weight.

In the example shown on the next page, for an allowable working stress of 400 psi, a main gear load of 70,000 lb, and a subgrade strength (k) of 300, the required rigid pavement thickness is 7.7 in. Similar examples are shown in succeeding charts.

NOTES:

- * TIRES - H40 x 14 - 16 22 PR; C40 x 14 - 21 22PR
- * PRESSURE RANGE FROM 138 TO 146 PSI (9.70 TO 10.27 KG/SQ CM)

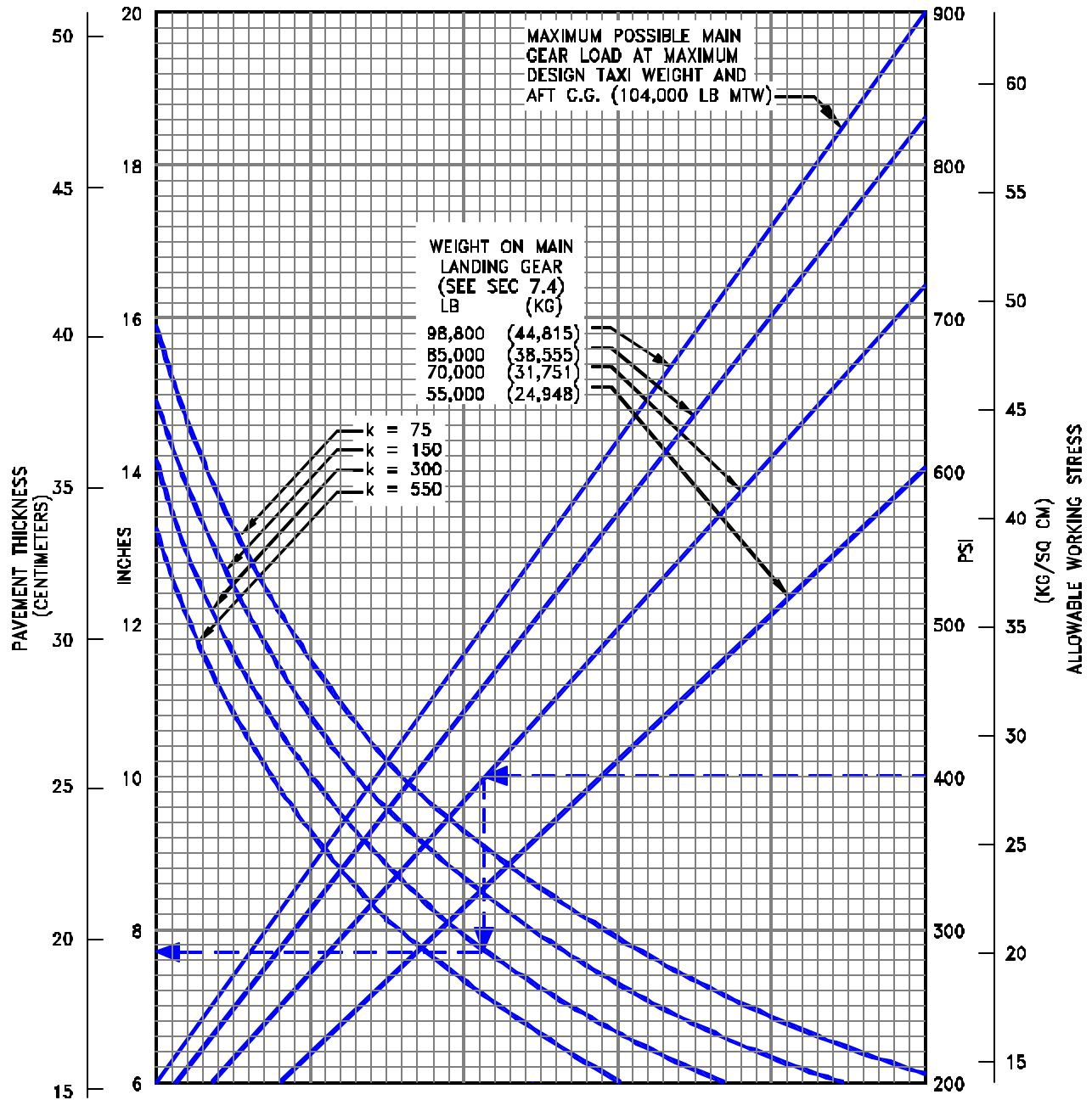

NOTE:
 THE VALUES OBTAINED BY USING THE MAXIMUM LOAD REFERENCE LINE AND ANY VALUE OF k ARE EXACT. FOR LOADS LESS THAN MAXIMUM, THE CURVES ARE EXACT FOR k = 300 BUT DEVIATE SLIGHTLY FOR OTHER VALUES OF k.

REFERENCES:
 "DESIGN OF CONCRETE AIRPORT PAVEMENT" AND "COMPUTER PROGRAM FOR AIRPORT PAVEMENT DESIGN - PROGRAM PDILB"
 PORTLAND CEMENT ASSOCIATION.

7.7.1 RIGID PAVEMENT REQUIREMENTS - PORTLAND CEMENT ASSOCIATION DESIGN METHOD

MODEL 737-100, -200 TO 104,000 LB (47,170 KG) MTW

NOTES:

- * TIRES - H40 x 14 - 16 24 PR; C40 x 14 - 21 24PR
- * PRESSURE RANGE FROM 156 TO 168 PSI (10.97 TO 18.81 KG/SQ CM)

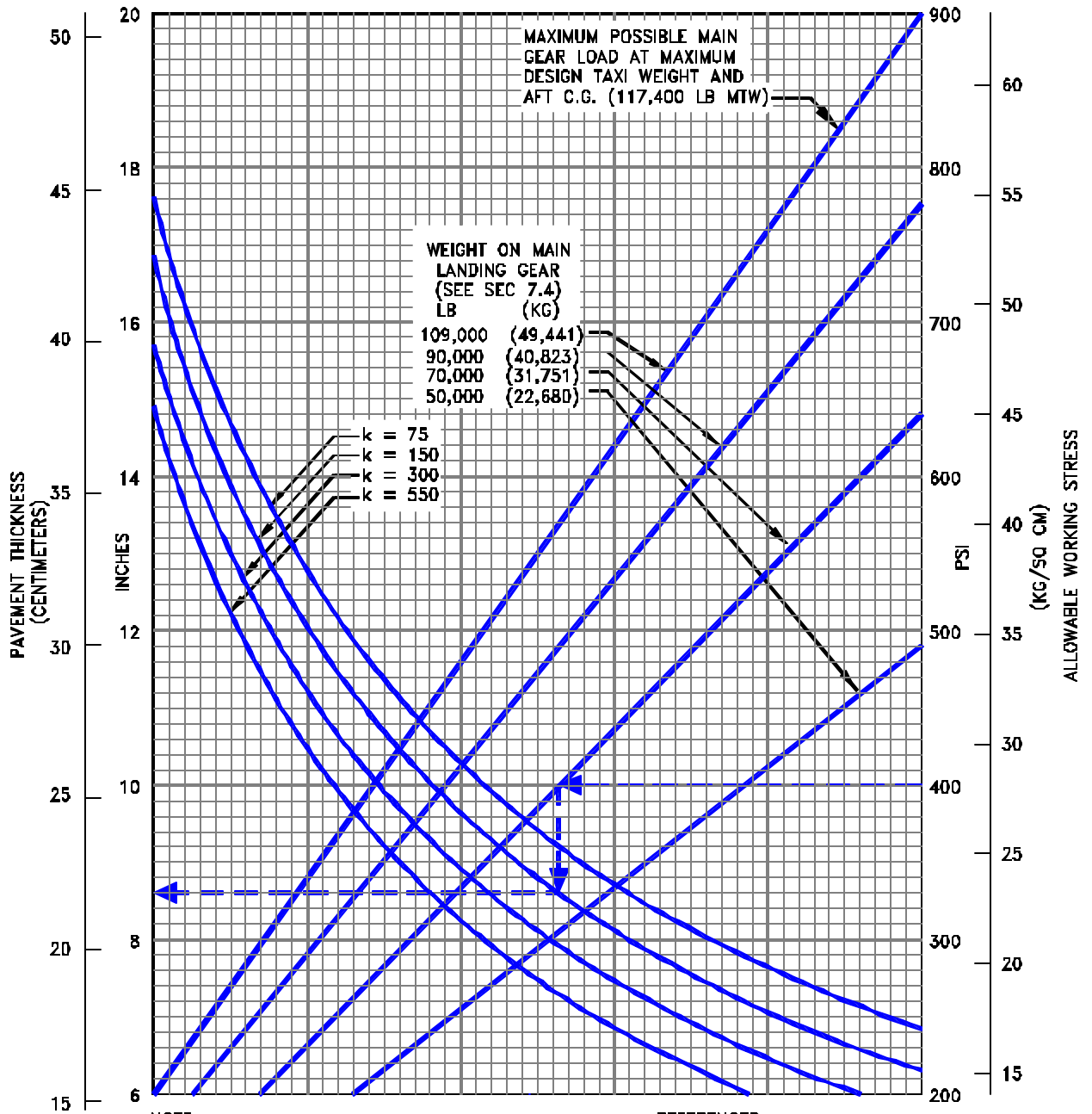

NOTE:
 THE VALUES OBTAINED BY USING THE MAXIMUM LOAD REFERENCE LINE AND ANY VALUE OF k ARE EXACT. FOR LOADS LESS THAN MAXIMUM, THE CURVES ARE EXACT FOR k = 300 BUT DEVIATE SLIGHTLY FOR OTHER VALUES OF k.

REFERENCES:
 "DESIGN OF CONCRETE AIRPORT PAVEMENT" AND "COMPUTER PROGRAM FOR AIRPORT PAVEMENT DESIGN - PROGRAM PDILB" PORTLAND CEMENT ASSOCIATION.

7.7.2 RIGID PAVEMENT REQUIREMENTS - PORTLAND CEMENT ASSOCIATION DESIGN METHOD

MODEL 737-100, -200, ADVANCED 737-200 AT 110,000 TO 117,500 LB (49,900 TO 53,290 KG) MTW

NOTES:

- * TIRES - C40 x 18 - 17 20 PR
- * PRESSURE AT 95 OR 96 PSI (6.68 OR 6.75 KG/SQ CM)

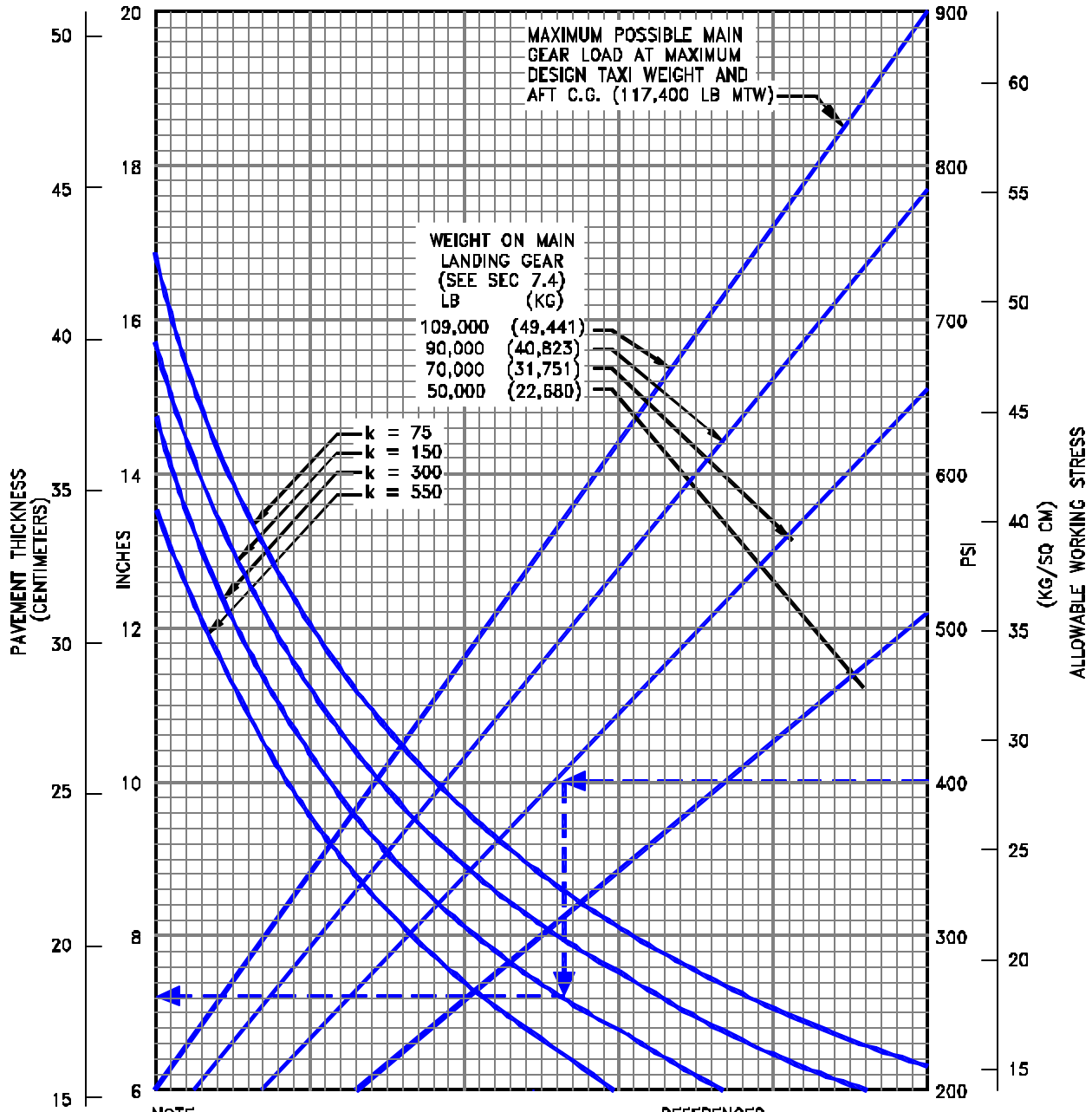

NOTE:
 THE VALUES OBTAINED BY USING THE MAXIMUM LOAD REFERENCE LINE AND ANY VALUE OF k ARE EXACT. FOR LOADS LESS THAN MAXIMUM, THE CURVES ARE EXACT FOR k = 300 BUT DEVIATE SLIGHTLY FOR OTHER VALUES OF k.

REFERENCES:
 "DESIGN OF CONCRETE AIRPORT PAVEMENT" AND "COMPUTER PROGRAM FOR AIRPORT PAVEMENT DESIGN - PROGRAM PDILB"
 PORTLAND CEMENT ASSOCIATION.

7.7.3 RIGID PAVEMENT REQUIREMENTS - PORTLAND CEMENT ASSOCIATION DESIGN METHOD

MODEL ADV 737-200 AT 116,000 TO 117,500 LB (52,610 TO 53,290 KG) MTW (LOW PRESSURE TIRES)

NOTES:

- * TIRES - H40 x 14-16 24PR; C40 x 14- 1 24PR OR 26PR; H40 x 14.5-19 24PR
- * PRESSURE RANGE FROM 170 TO 182 PSI (11.95 TO 12.80 KG/SQ CM)

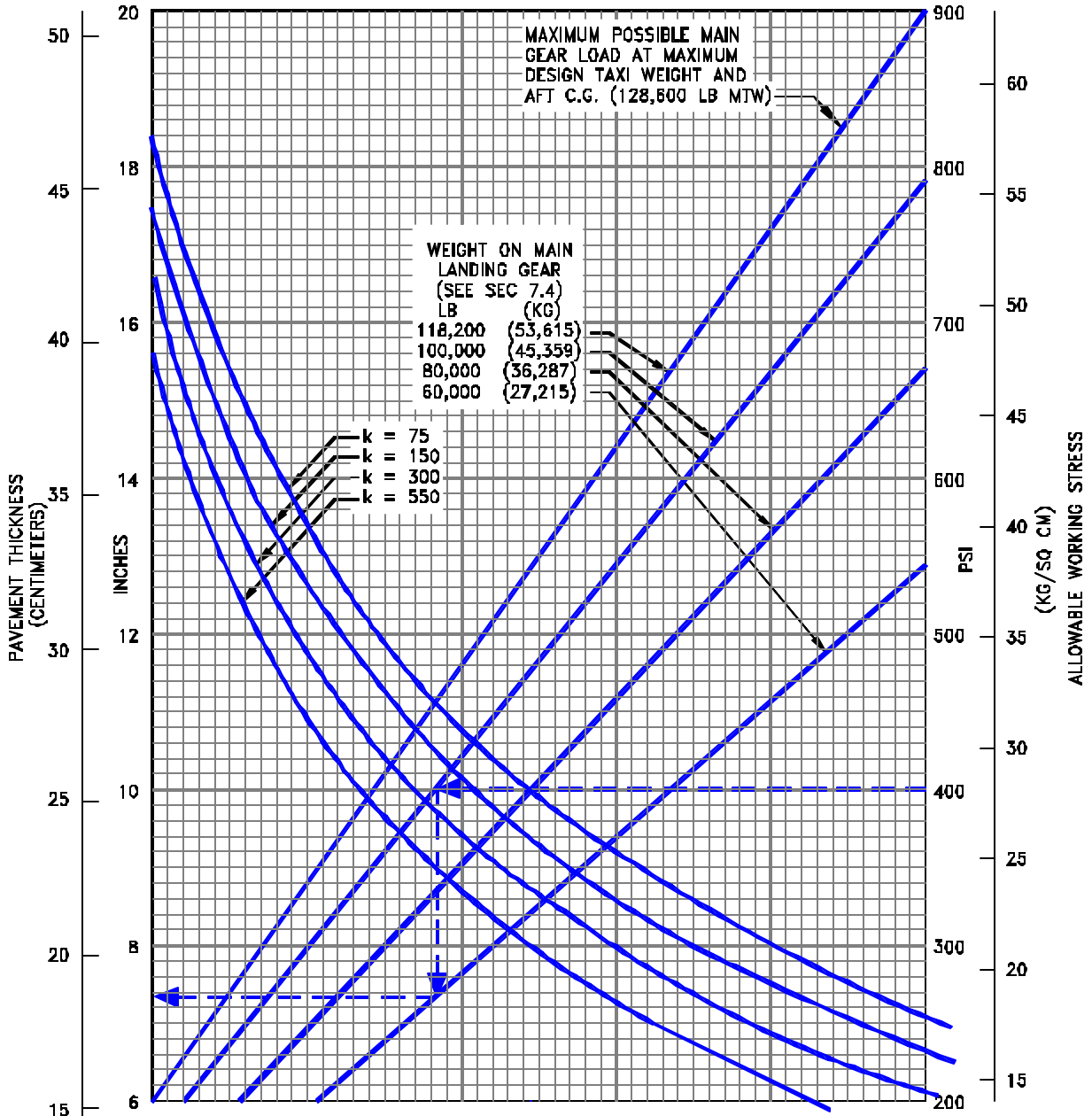

NOTE:
 THE VALUES OBTAINED BY USING THE MAXIMUM LOAD REFERENCE LINE AND ANY VALUE OF k ARE EXACT. FOR LOADS LESS THAN MAXIMUM, THE CURVES ARE EXACT FOR k = 300 BUT DEVIATE SLIGHTLY FOR OTHER VALUES OF k.

REFERENCES:
 "DESIGN OF CONCRETE AIRPORT PAVEMENT" AND "COMPUTER PROGRAM FOR AIRPORT PAVEMENT DESIGN - PROGRAM PDILB" PORTLAND CEMENT ASSOCIATION.

7.7.4 RIGID PAVEMENT REQUIREMENTS - PORTLAND CEMENT ASSOCIATION DESIGN METHOD

MODEL ADV 737-200 AT 120,000 TO 128,000 LB (54,430 TO 58,330 KG) MTW

NOTES:

* TIRES - H40 x 14.5-19 24PR, 26PR; H42 x 16-19 26PR

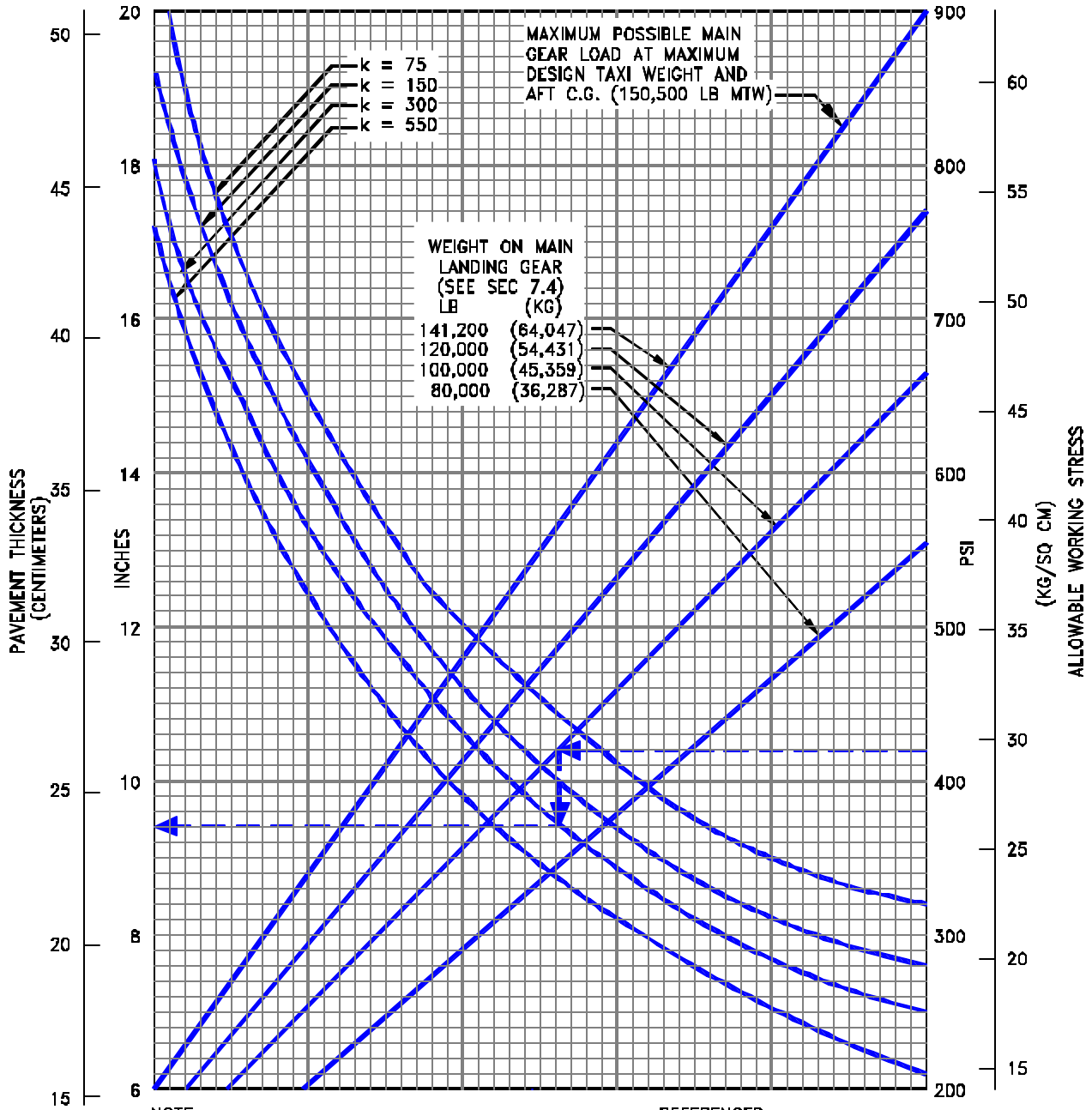

MAXIMUM POSSIBLE MAIN GEAR LOAD AT MAXIMUM DESIGN TAXI WEIGHT AND AFT C.G. (150,500 LB MTW)

WEIGHT ON MAIN LANDING GEAR (SEE SEC 7.4)

LB	(KG)
141,200	(64,047)
120,000	(54,431)
100,000	(45,359)
80,000	(36,287)

NOTE:
 THE VALUES OBTAINED BY USING THE MAXIMUM LOAD REFERENCE LINE AND ANY VALUE OF k ARE EXACT. FOR LOADS LESS THAN MAXIMUM, THE CURVES ARE EXACT FOR k = 300 BUT DEVIATE SLIGHTLY FOR OTHER VALUES OF k.

REFERENCES:
 "DESIGN OF CONCRETE AIRPORT PAVEMENT" AND "COMPUTER PROGRAM FOR AIRPORT PAVEMENT DESIGN - PROGRAM PDILB" PORTLAND CEMENT ASSOCIATION.

7.7.5 RIGID PAVEMENT REQUIREMENTS - PORTLAND CEMENT ASSOCIATION DESIGN METHOD

MODEL 737-300, -400, -500

NOTES:

* TIRES - H42 x 16-19 26PR

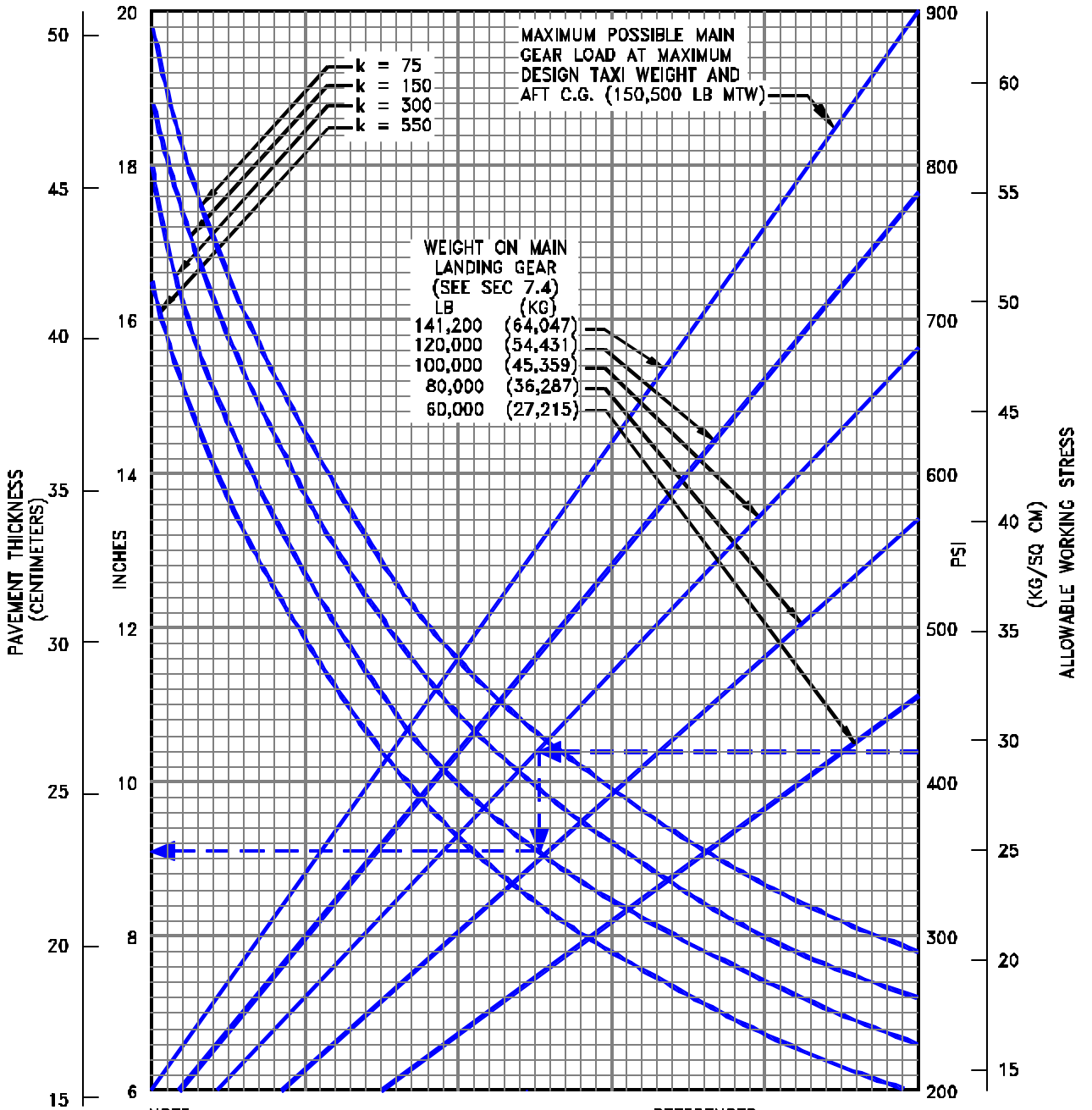

NOTE:
 THE VALUES OBTAINED BY USING THE MAXIMUM LOAD REFERENCE LINE AND ANY VALUE OF k ARE EXACT. FOR LOADS LESS THAN MAXIMUM, THE CURVES ARE EXACT FOR k = 300 BUT DEVIATE SLIGHTLY FOR OTHER VALUES OF k.

REFERENCES:
 "DESIGN OF CONCRETE AIRPORT PAVEMENT" AND "COMPUTER PROGRAM FOR AIRPORT PAVEMENT DESIGN - PROGRAM PDILB"
 PORTLAND CEMENT ASSOCIATION.

7.7.5 RIGID PAVEMENT REQUIREMENTS - PORTLAND CEMENT ASSOCIATION DESIGN METHOD

MODEL 737-300, -400, -500 (LOW PRESSURE TIRES)

NOTE: TIRES - H44.5 x 16.5 - 21 30PR

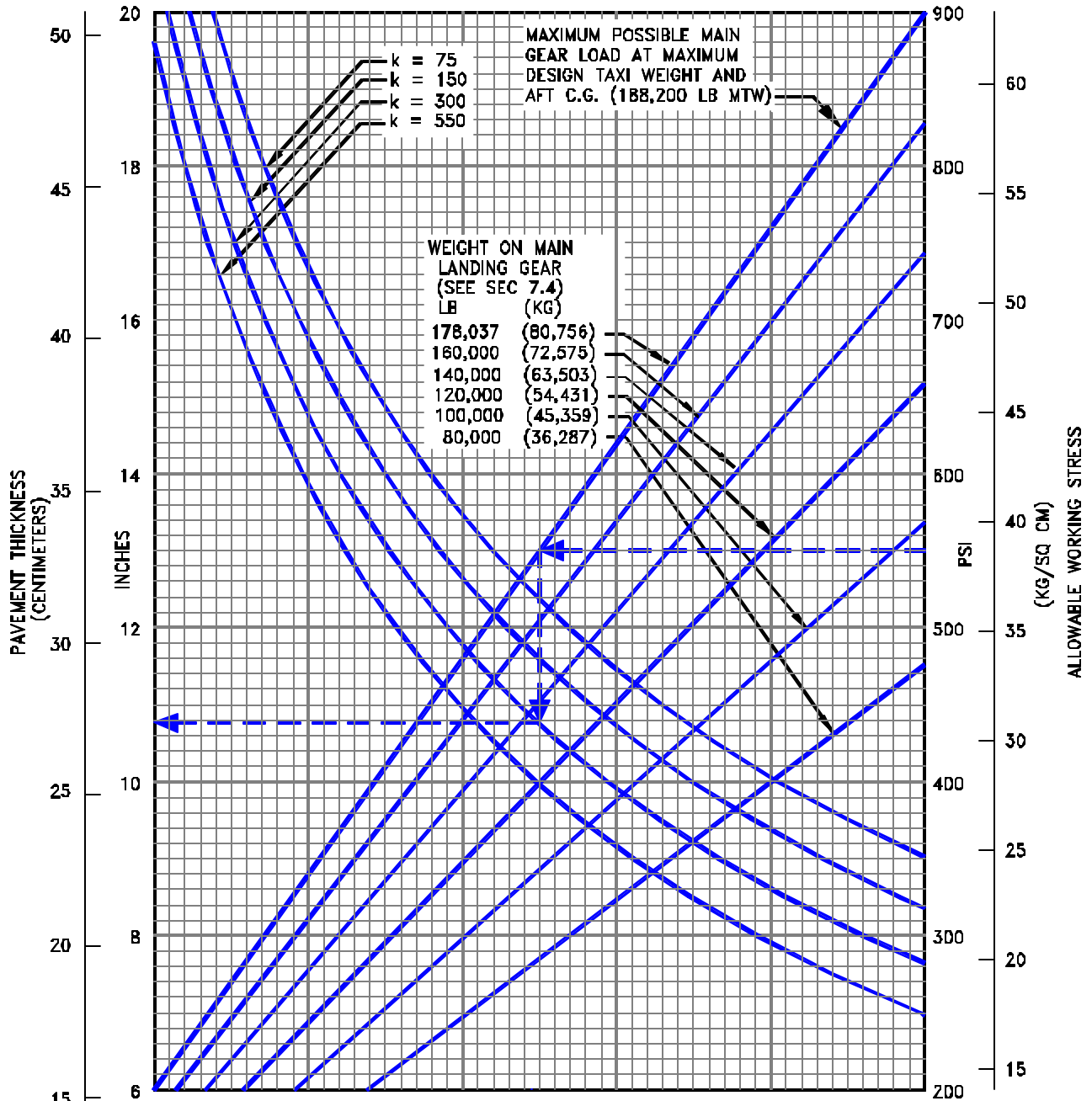

NOTE:
 THE VALUES OBTAINED BY USING THE MAXIMUM LOAD REFERENCE LINE AND ANY VALUE OF k ARE EXACT. FOR LOADS LESS THAN MAXIMUM, THE CURVES ARE EXACT FOR k = 300 BUT DEVIATE SLIGHTLY FOR OTHER VALUES OF k.

REFERENCES:
 "DESIGN OF CONCRETE AIRPORT PAVEMENT" AND "COMPUTER PROGRAM FOR AIRPORT PAVEMENT DESIGN - PROGRAM PDILB"
 PORTLAND CEMENT ASSOCIATION.

7.7.6 RIGID PAVEMENT REQUIREMENTS - PORTLAND CEMENT ASSOCIATION DESIGN METHOD

MODEL 737-600, -700, -800, -900, -900ER WITH AND WITHOUT WINGLETS, 737 BBJ, 737 BBJ2

NOTE: TIRES - H44.5 x 16.5 - 21 28PR

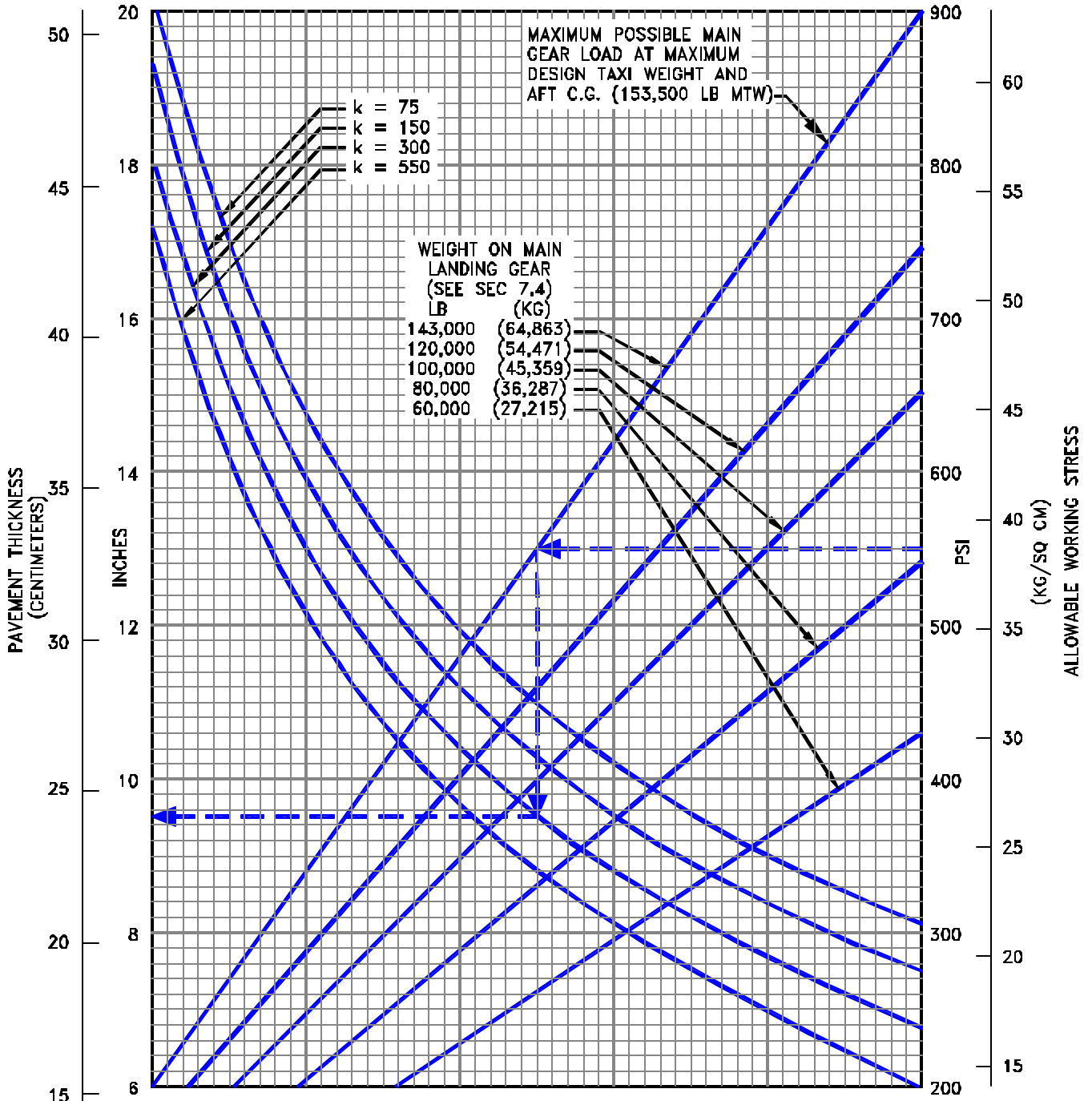

7.7.7 RIGID PAVEMENT REQUIREMENTS - PORTLAND CEMENT ASSOCIATION DESIGN METHOD

MODEL 737-600, -700 (OPTIONAL TIRES)

7.8 Rigid Pavement Requirements - LCN Conversion

To determine the airplane weight that can be accommodated on a particular rigid pavement, both the LCN of the pavement and the radius of relative stiffness (t) of the pavement must be known.

In the example shown in Section 7.8.2, for a rigid pavement with a radius of relative stiffness of 40 with an LCN of 42.5, the maximum allowable weight permissible on the main landing gear is 85,000 lb. Similar examples are shown in succeeding charts.

Note: If the resultant aircraft LCN is not more than 10% above the published pavement LCN, the bearing strength of the pavement can be considered sufficient for unlimited use by the airplane. The figure 10% has been chosen as representing the lowest degree of variation in LCN that is significant (reference: ICAO Aerodrome Manual, Part 2, "Aerodrome Physical Characteristics," Chapter 4, Paragraph 4.1.5.7v, 2nd Edition dated 1965).

RADIUS OF RELATIVE STIFFNESS (l)
VALUES IN INCHES

$$l = \sqrt[4]{\frac{Ed^3}{12(1-\mu^2)k}} = 24.1652 \sqrt[4]{\frac{d^3}{k}}$$

WHERE: E = YOUNG'S MODULUS OF ELASTICITY = 4 x 10⁶ psi
 k = SUBGRADE MODULUS, LB PER CU IN
 d = RIGID PAVEMENT THICKNESS, IN
 μ = POISSON'S RATIO = 0.15

d	k = 75	k = 100	k = 150	k = 200	k = 250	k = 300	k = 350	k = 400	k = 500	k = 550
6.0	31.48	29.29	26.47	24.63	23.30	22.26	21.42	20.71	19.59	19.13
6.5	33.42	31.10	28.11	26.16	24.74	23.63	22.74	21.99	20.80	20.31
7.0	35.33	32.88	29.71	27.65	26.15	24.99	24.04	23.25	21.99	21.47
7.5	37.21	34.63	31.29	29.12	27.54	26.31	25.32	24.49	23.16	22.61
8.0	39.06	36.35	32.84	30.56	28.91	27.62	26.57	25.70	24.31	23.73
8.5	40.87	38.04	34.37	31.99	30.25	28.90	27.81	26.90	25.44	24.84
9.0	42.66	39.70	35.88	33.39	31.57	30.17	29.03	28.07	26.55	25.93
9.5	44.43	41.35	37.36	34.77	32.88	31.42	30.23	29.24	27.65	27.00
10.0	46.17	42.97	38.83	36.13	34.17	32.65	31.41	30.38	28.73	28.06
10.5	47.89	44.57	40.27	37.48	35.44	33.87	32.58	31.52	29.81	29.10
11.0	49.59	46.15	41.70	38.81	36.70	35.07	33.74	32.63	30.86	30.14
11.5	51.27	47.72	43.12	40.12	37.95	36.26	34.89	33.74	31.91	31.16
12.0	52.94	49.26	44.51	41.43	39.18	37.43	36.02	34.83	32.94	32.17
12.5	54.58	50.80	45.90	42.71	40.40	38.60	37.14	35.92	33.97	33.17
13.0	56.21	52.31	47.27	43.99	41.60	39.75	38.25	36.99	34.98	34.16
13.5	57.83	53.81	48.63	45.25	42.80	40.89	39.34	38.05	35.99	35.14
14.0	59.43	55.30	49.97	46.50	43.98	42.02	40.43	39.10	36.98	36.11
14.5	61.01	56.78	51.30	47.74	45.15	43.14	41.51	40.15	37.97	37.07
15.0	62.58	58.24	52.62	48.97	46.32	44.25	42.58	41.18	38.95	38.03
15.5	64.14	59.69	53.93	50.19	47.47	45.35	43.64	42.21	39.92	38.98
16.0	65.69	61.13	55.23	51.40	48.61	46.45	44.69	43.22	40.88	39.92
16.5	67.22	62.55	56.52	52.60	49.75	47.53	45.73	44.23	41.83	40.85
17.0	68.74	63.97	57.80	53.79	50.87	48.61	46.77	45.23	42.78	41.77
17.5	70.25	65.38	59.07	54.97	51.99	49.68	47.80	46.23	43.72	42.69
18.0	71.75	66.77	60.34	56.15	53.10	50.74	48.82	47.22	44.65	43.60
19.0	74.72	69.54	62.83	58.47	55.30	52.84	50.84	49.17	46.50	45.41
20.0	77.65	72.26	65.30	60.77	57.47	54.91	52.83	51.10	48.33	47.19
21.0	80.55	74.96	67.73	63.03	59.61	56.95	54.80	53.00	50.13	48.95
22.0	83.41	77.62	70.14	65.27	61.73	58.98	56.75	54.88	51.91	50.68
23.0	86.23	80.25	72.51	67.48	63.82	60.98	58.67	56.74	53.67	52.40
24.0	89.03	82.85	74.86	69.67	65.89	62.95	60.57	58.58	55.41	54.10
25.0	91.80	85.43	77.19	71.84	67.94	64.91	62.46	60.41	57.13	55.78

**7.8.1 RADIUS OF RELATIVE STIFFNESS
(REFERENCE: PORTLAND CEMENT ASSOCIATION)**

- NOTES:
- * TIRES - 40x14-16 22PR; C40x14-21 22PR
 - * PRESSURE RANGE FROM 138 TO 146 PSI (9.70 TO 10.27 KG/SQ CM)
 - * EQUIVALENT SINGLE-WHEEL LOADS ARE DERIVED FROM ICAO AERODROME MANUAL, PART 2 PAR 4.1.3, DATED 1965.

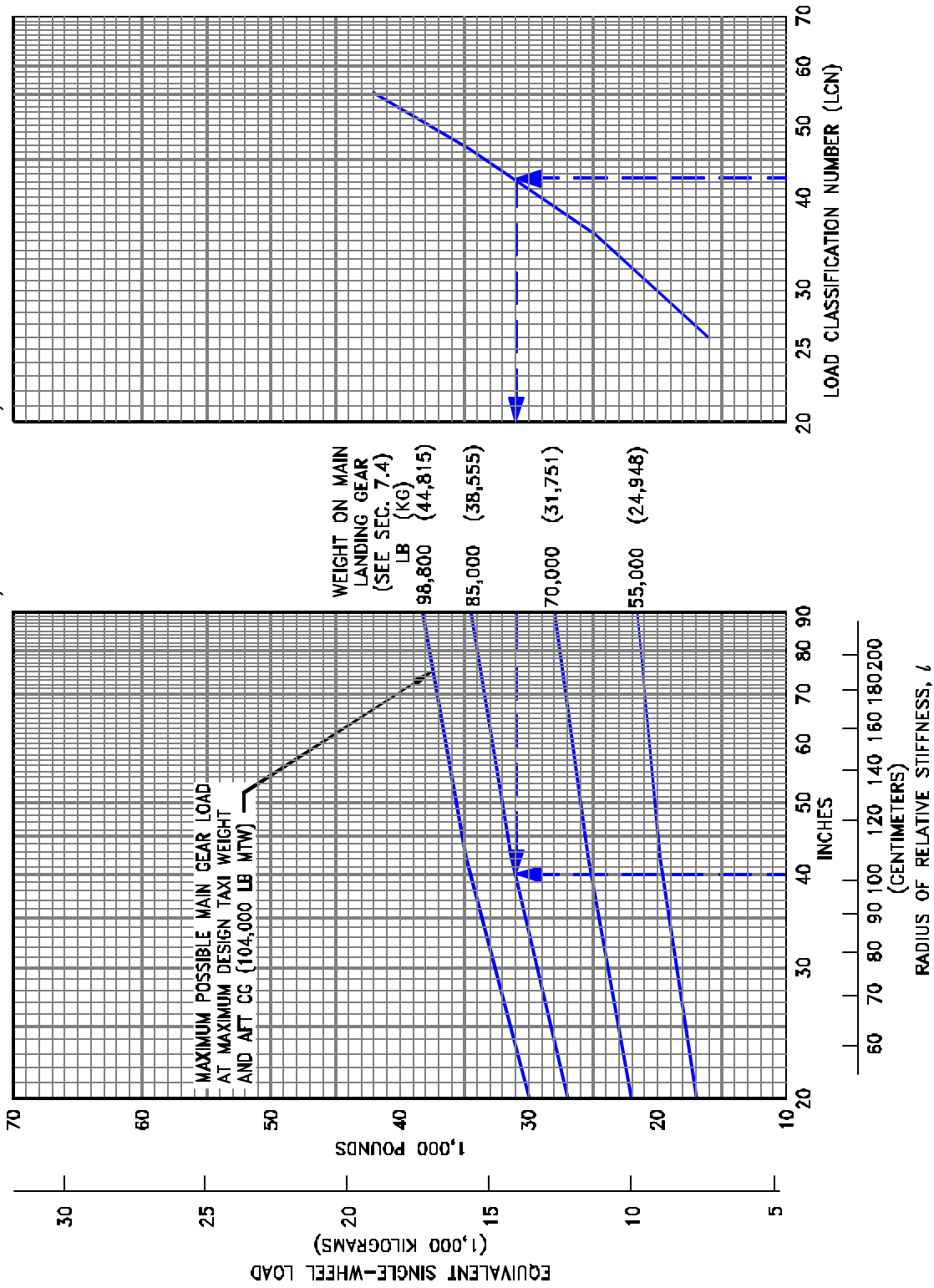

7.8.2 RIGID PAVEMENT REQUIREMENTS - LCN CONVERSION

MODEL 737-100, -200 TO 104,000 LB (47,170 KG) MTW

D6-58325-6

- NOTES:
- * TIRES - 40x14-1B 24PR; C40x14-21 24PR
 - * PRESSURE RANGE FROM 156 TO 168 PSI (10.97 TO 11.81 KG/SQ CM)
 - * EQUIVALENT SINGLE-WHEEL LOADS ARE DERIVED FROM ICAO AERODROME MANUAL, PART 2 PAR 4.1.3, DATED 1965.

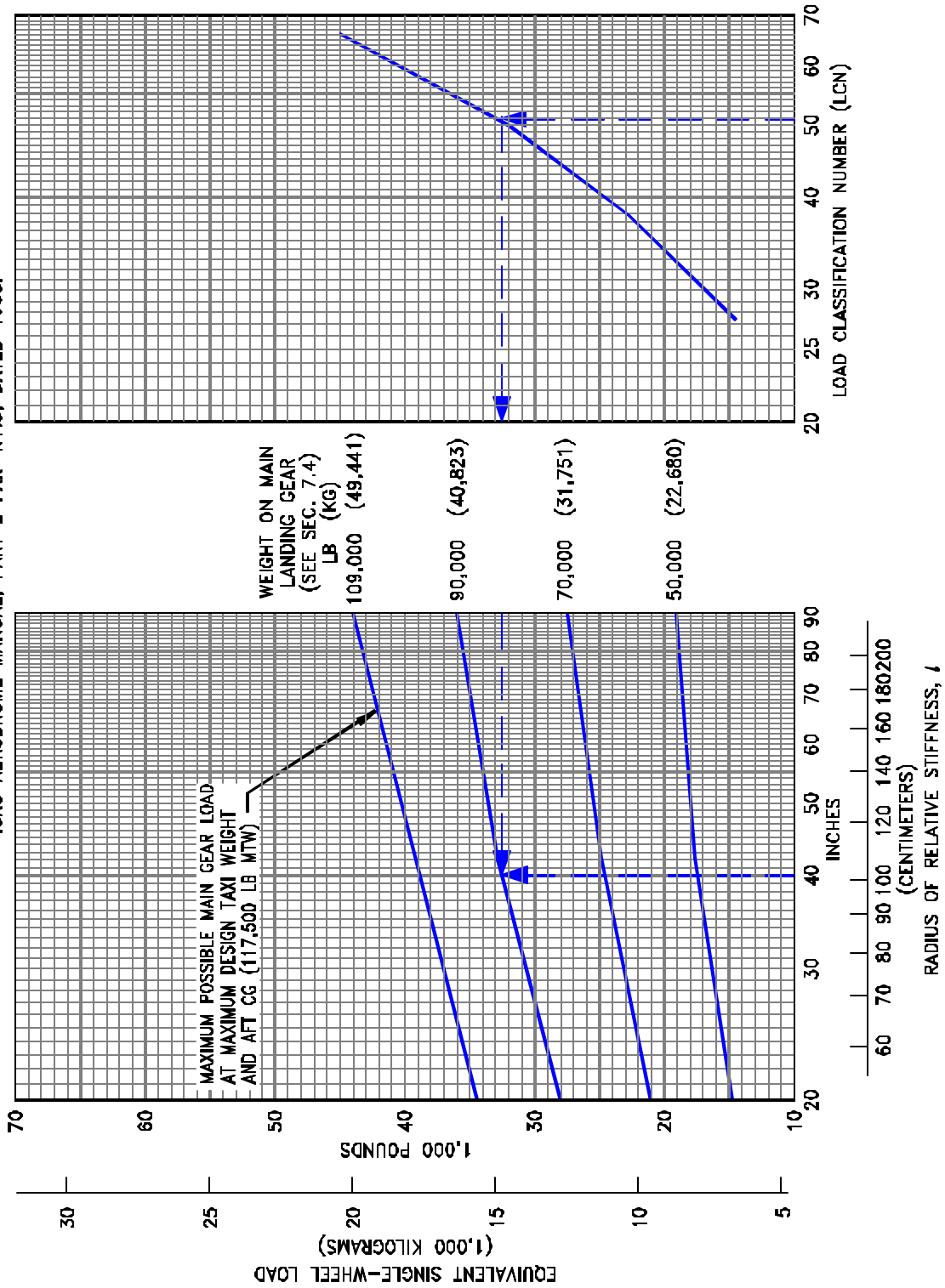

7.8.3 RIGID PAVEMENT REQUIREMENTS - LCN CONVERSION

MODEL 737-100, -200 AT 110,000 TO 117,500 LB (49,900 TO 53,290 KG) MTW

- NOTES:
- * TIRES - C40x18-17 20PR
 - * PRESSURE AT 95 OR 96 PSI (6.68 OR 6.75 KG/SQ CM)
 - * EQUIVALENT SINGLE-WHEEL LOADS ARE DERIVED FROM ICAO AERODROME MANUAL, PART 2 PAR 4.1.3, DATED 1965.

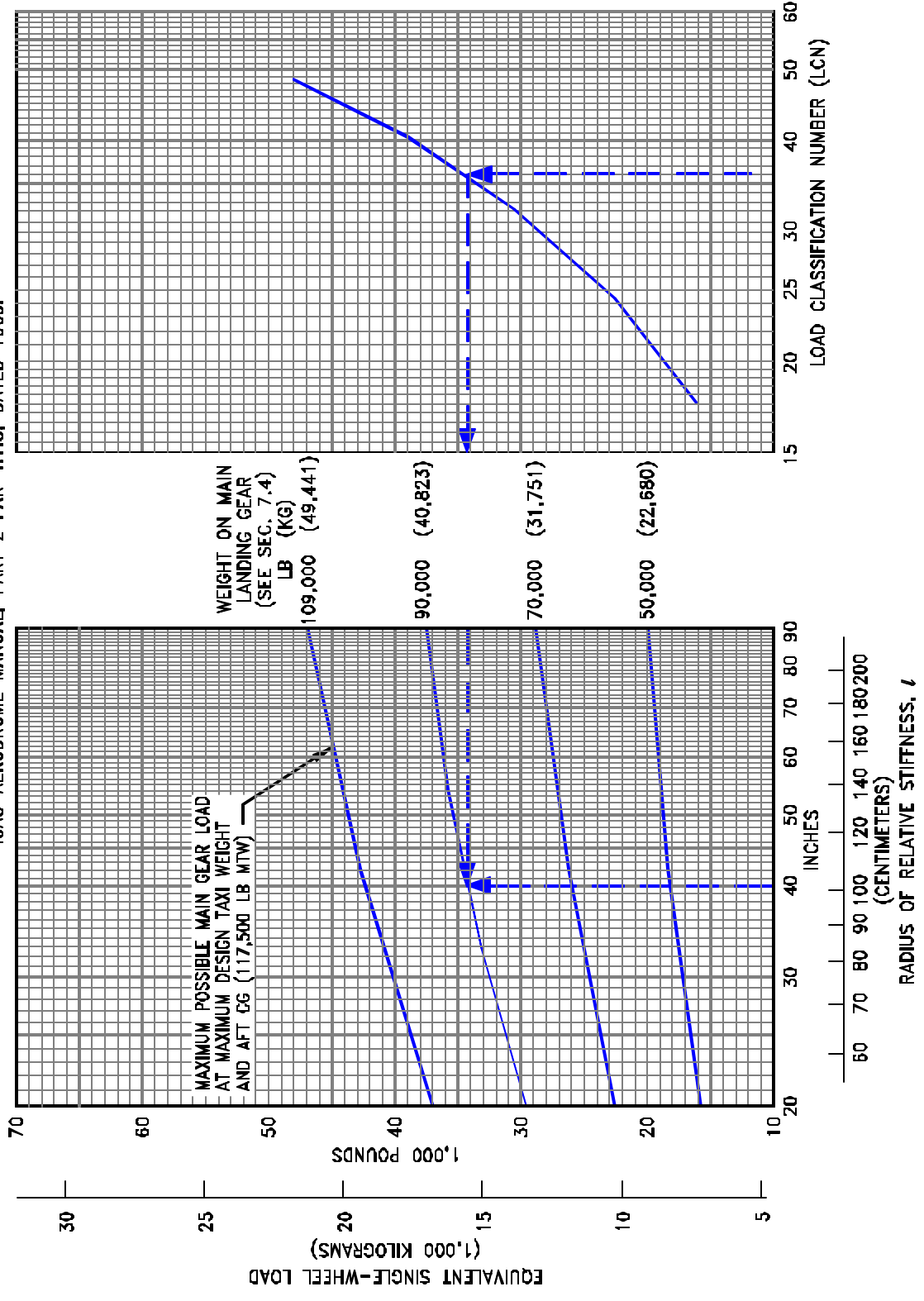

7.8.4 RIGID PAVEMENT REQUIREMENTS - LCN CONVERSION

MODEL ADV 737-200 AT 116,000 TO 117,500 LB (52,610 TO 53,290 KG) MTW (LOW PRESSURE TIRES)

- NOTES:
- * TIRES - 40x14-16 24PR; C40x14-21 24PR OR 26PR; H40x14.5-19 24PR
 - * PRESSURE RANGE FROM 170 TO 182 PSI (11.95 TO 12.80 KG/SQ CM)
 - * EQUIVALENT SINGLE-WHEEL LOADS ARE DERIVED FROM ICAC AERODROME MANUAL, PART 2 PAR 4.1.3, DATED 1965.

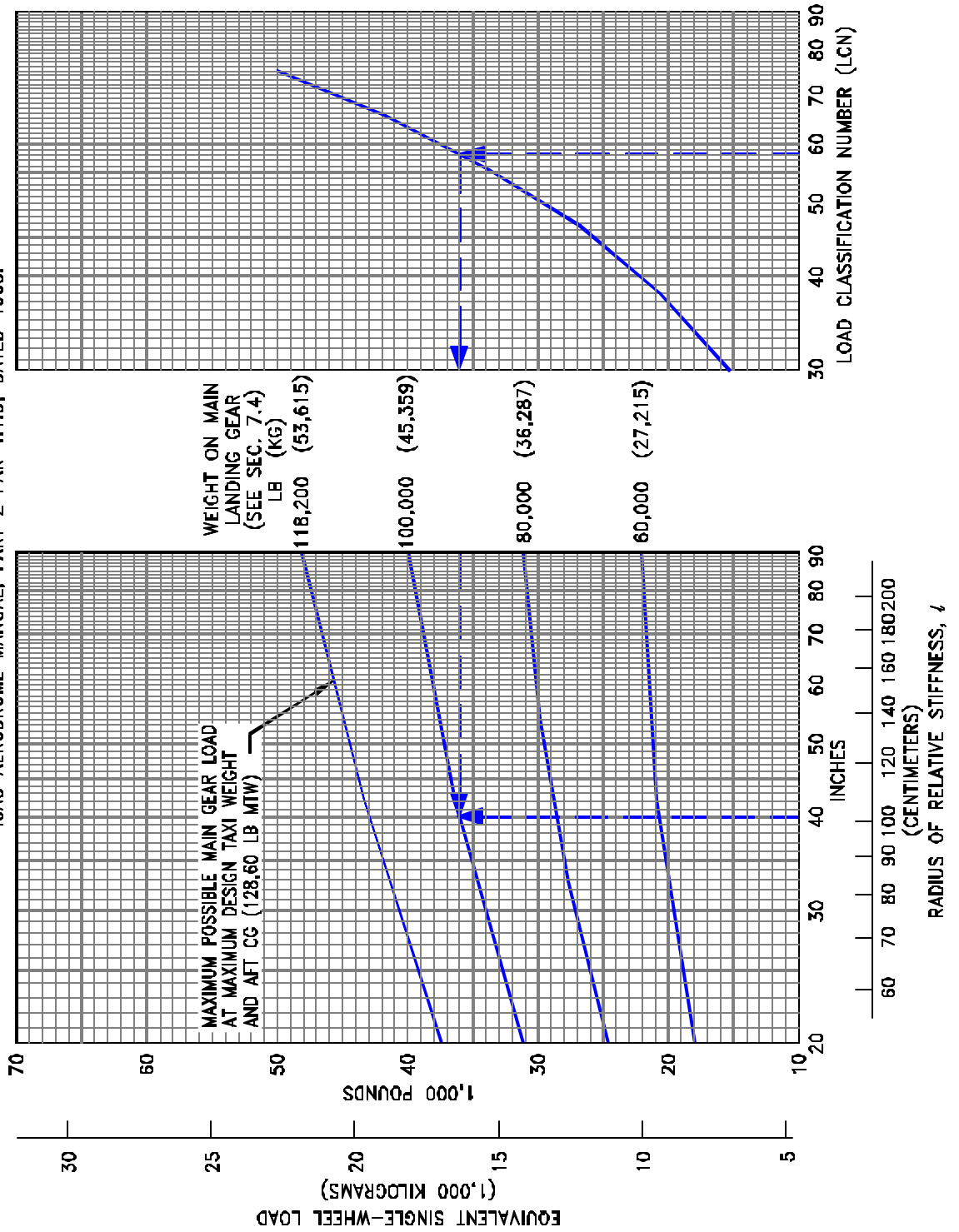

7.8.5 RIGID PAVEMENT REQUIREMENTS - LCN CONVERSION

MODEL ADV 737-200 AT 120,000 TO 128,600 LB (54,430 TO 58,330 KG) MTW

NOTES: * TIRES - H40 x 14.5-19 24PR, 26PR; H42 x 16-29 24PR, 26PR
 * EQUIVALENT SINGLE-WHEEL LOADS ARE DERIVED FROM ICAO AERODROME MANUAL, PART 2 PAR 4.1.3, DATED 1965.

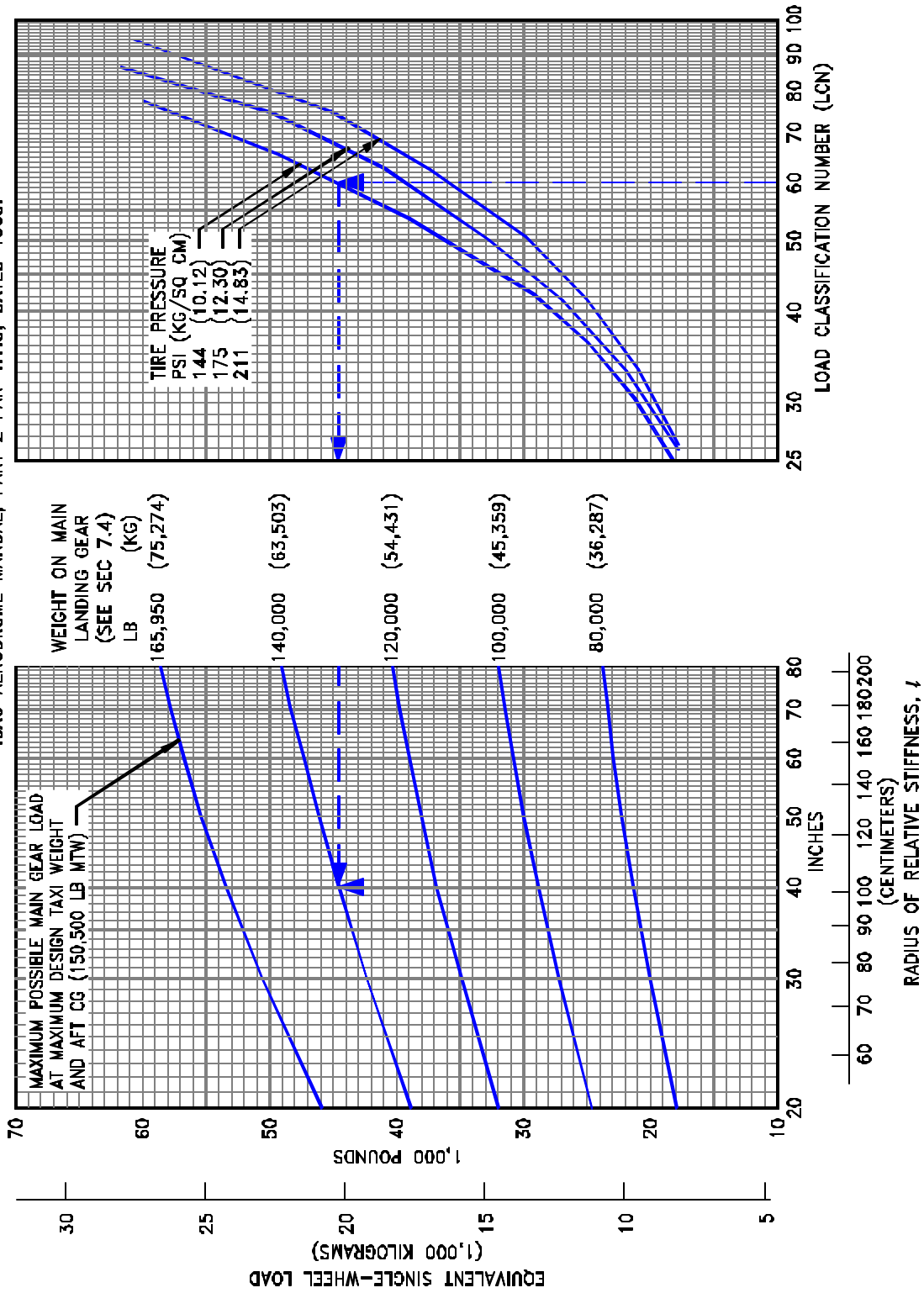

7.8.6 RIGID PAVEMENT REQUIREMENTS - LCN CONVERSION

MODEL 737-300, -400, -500

NOTES: * TIRES - H44.5 x 16.5 - 21 30PR
 * EQUIVALENT SINGLE-WHEEL LOADS ARE DERIVED FROM ICAO AERODROME MANUAL, PART 2 PAR 4.1.3, DATED 1965.

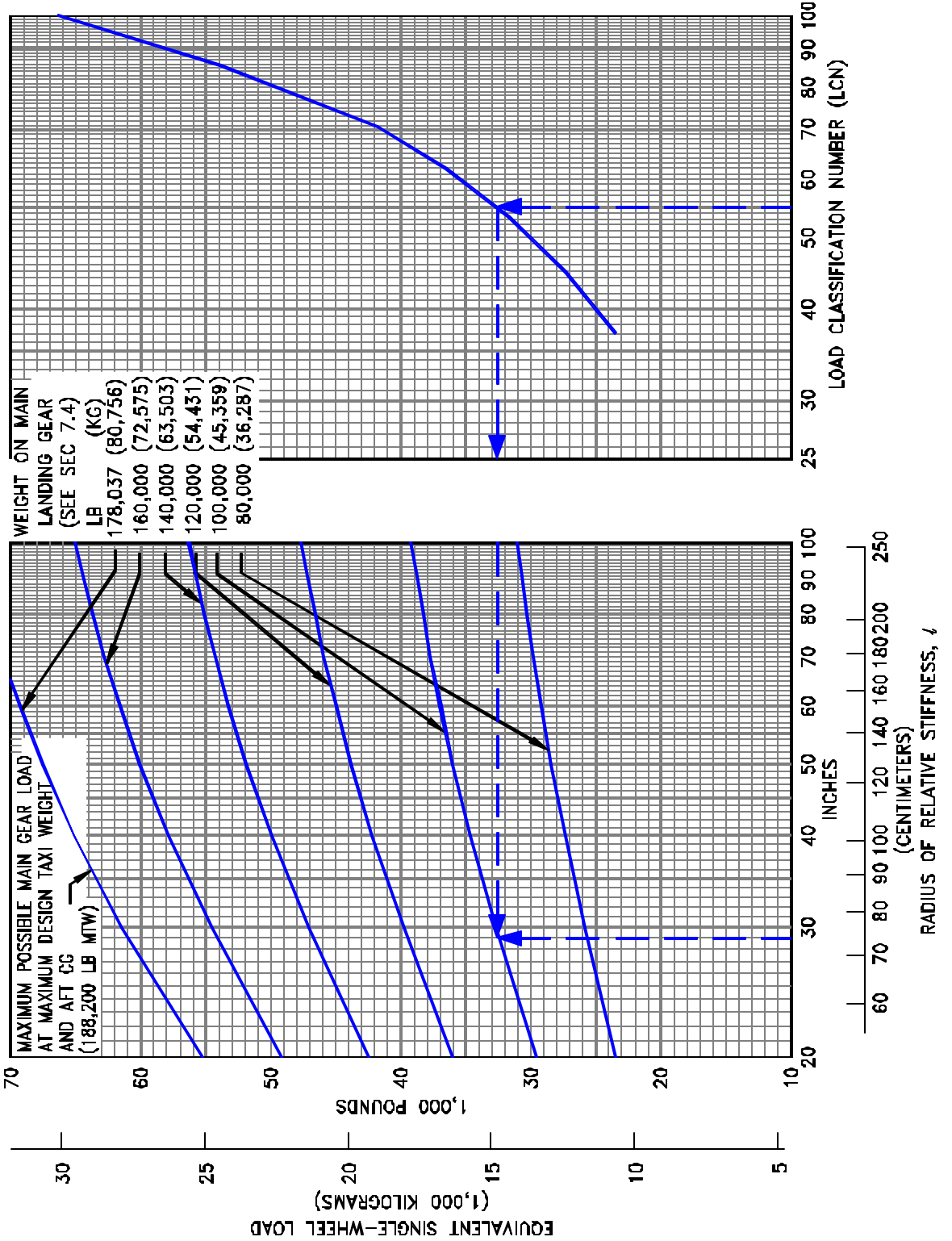

7.8.7 RIGID PAVEMENT REQUIREMENTS - LCN CONVERSION

MODEL 737-600, -700, -800, -900, -900ER WITH AND WITHOUT WINGLETS, 737 BBJ, 737 BBJ2

7.9 Rigid Pavement Requirements - FAA Design Method

The following rigid pavement design charts present data on five incremental main gear loads at the minimum tire pressure required at the maximum design taxi weight.

In the example shown in the next page, the pavement flexural stress is shown at 700 psi, the subgrade strength is shown at $k = 550$, and the annual departure level is 6,000. For these conditions, the required rigid pavement thickness for an airplane with main gear load of 100,000 pounds is 10.4 inches. Similar examples are shown in succeeding charts.

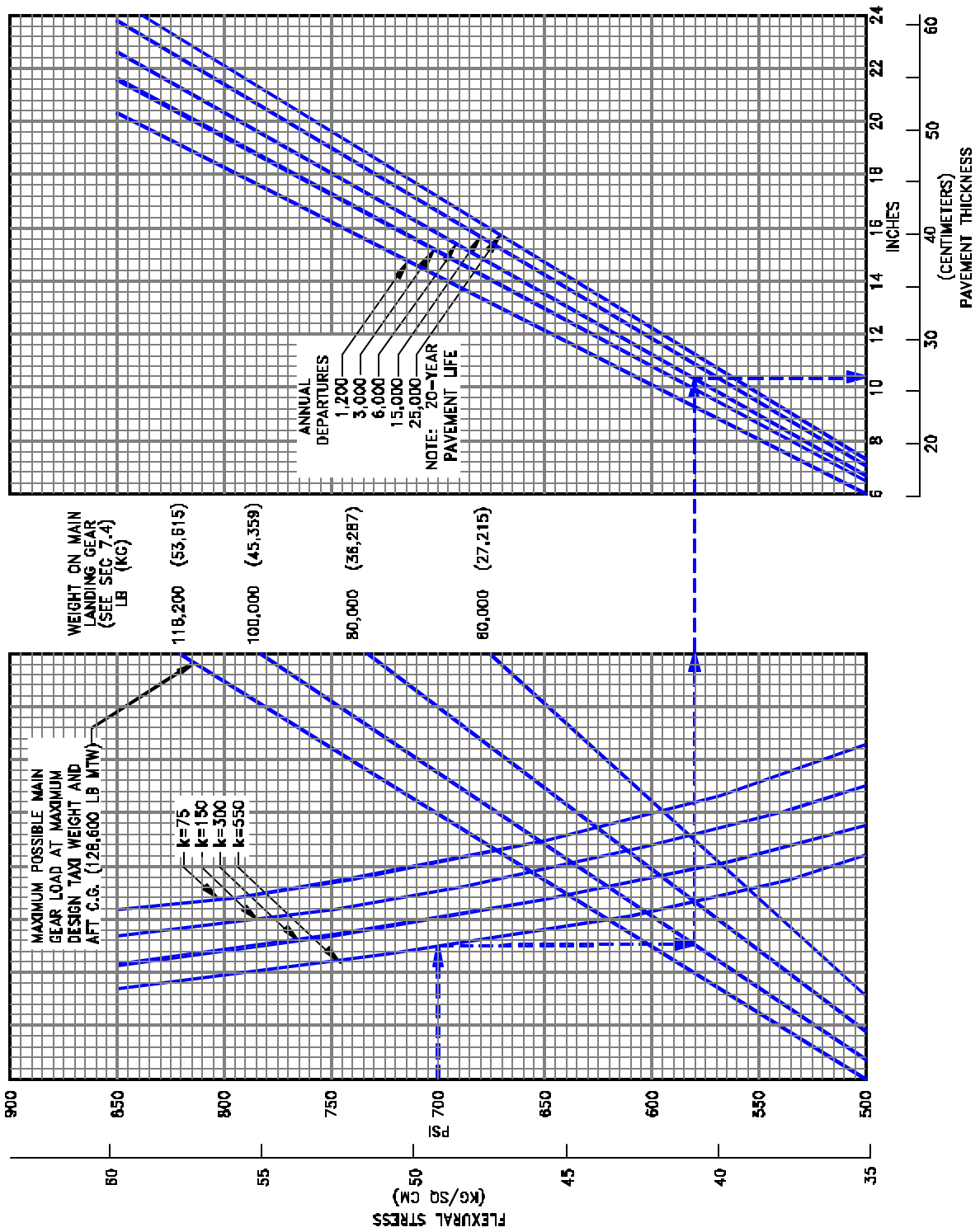

7.9.1 RIGID PAVEMENT REQUIREMENTS - FAA DESIGN METHOD
 MODEL 737-100, -200

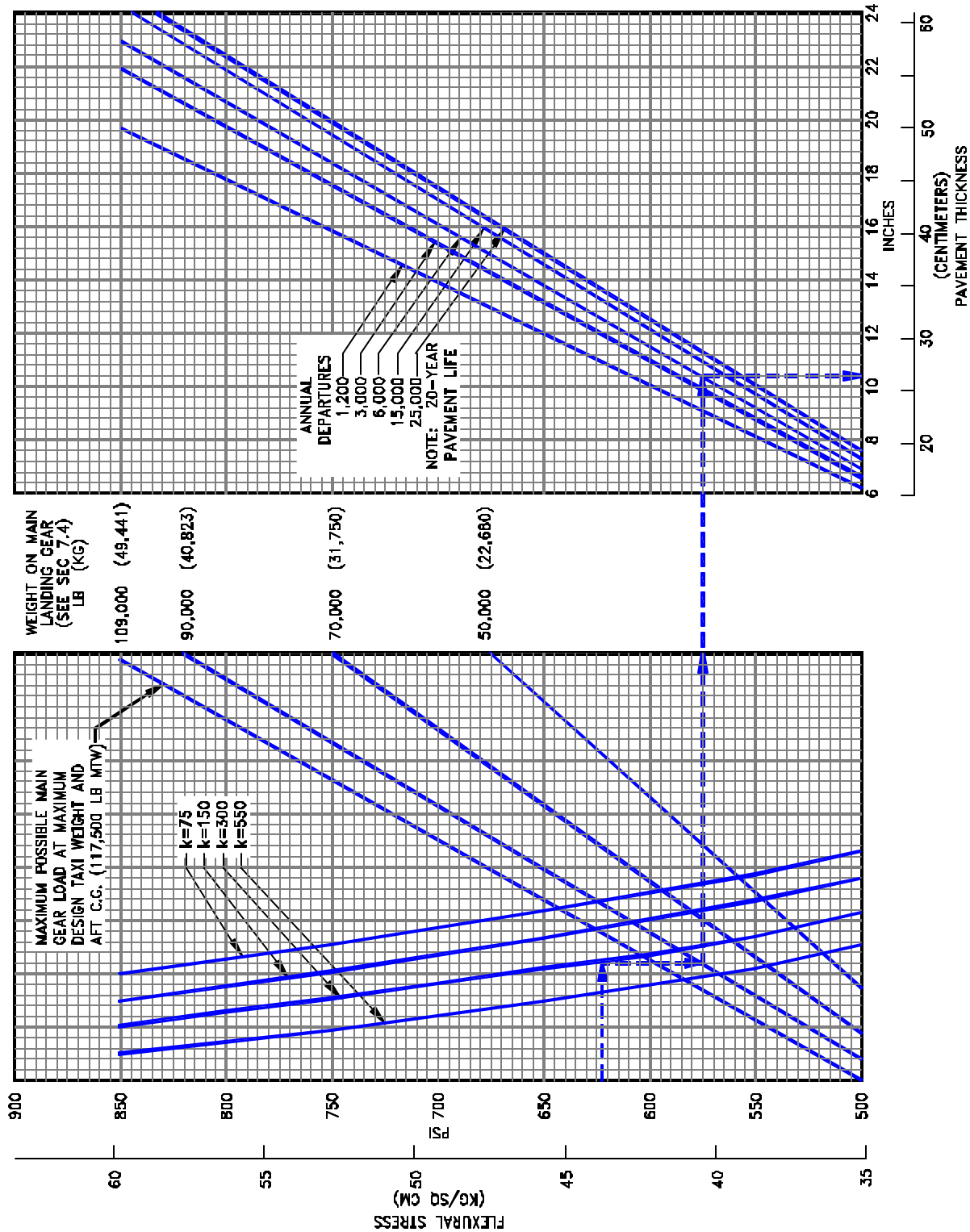

7.9.2 RIGID PAVEMENT REQUIREMENTS - FAA DESIGN METHOD
 MODEL ADV 737-200 (LOW PRESSURE TIRES)

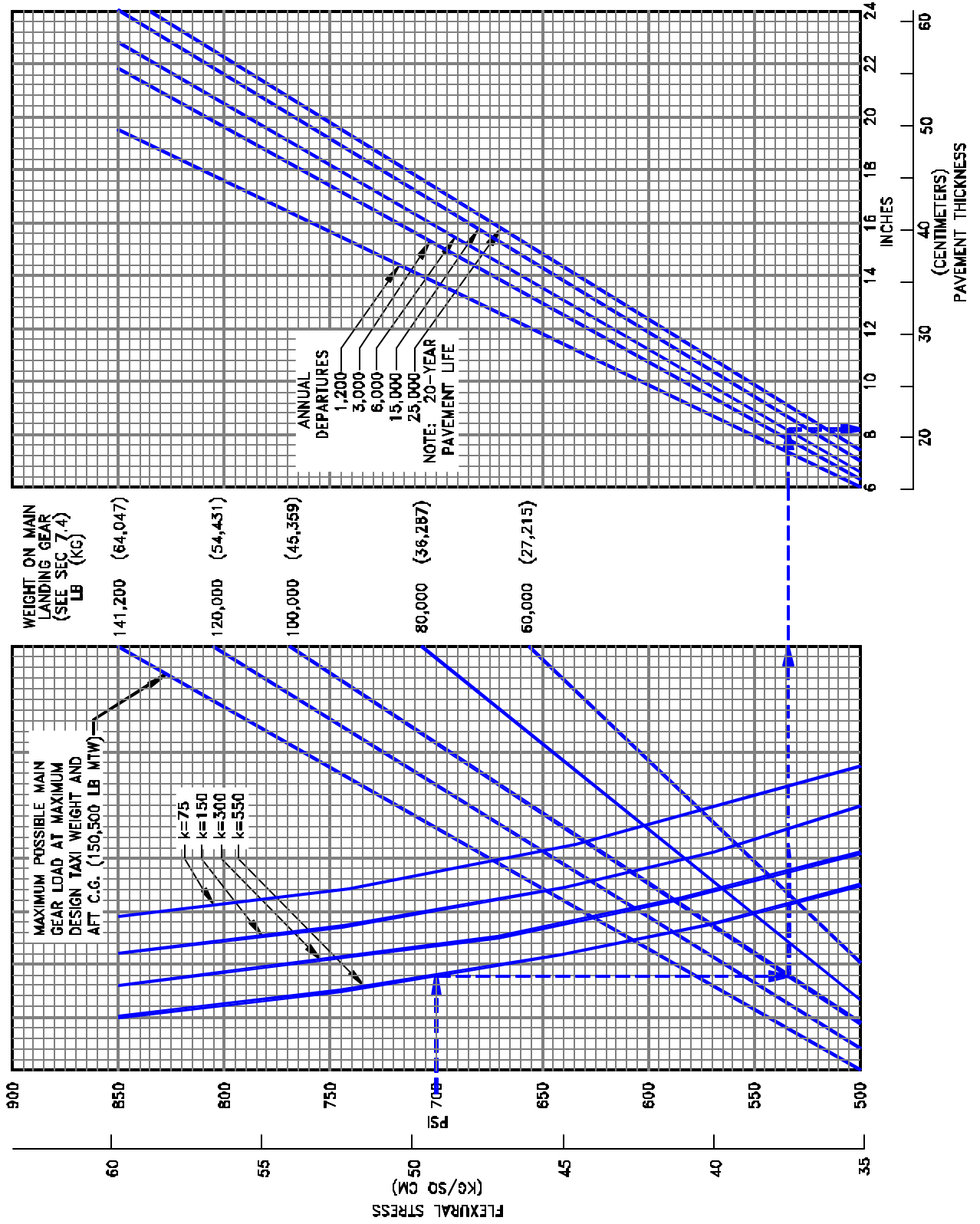

7.9.3 RIGID PAVEMENT REQUIREMENTS - FAA DESIGN METHOD
 MODEL 737-300, -400, -500

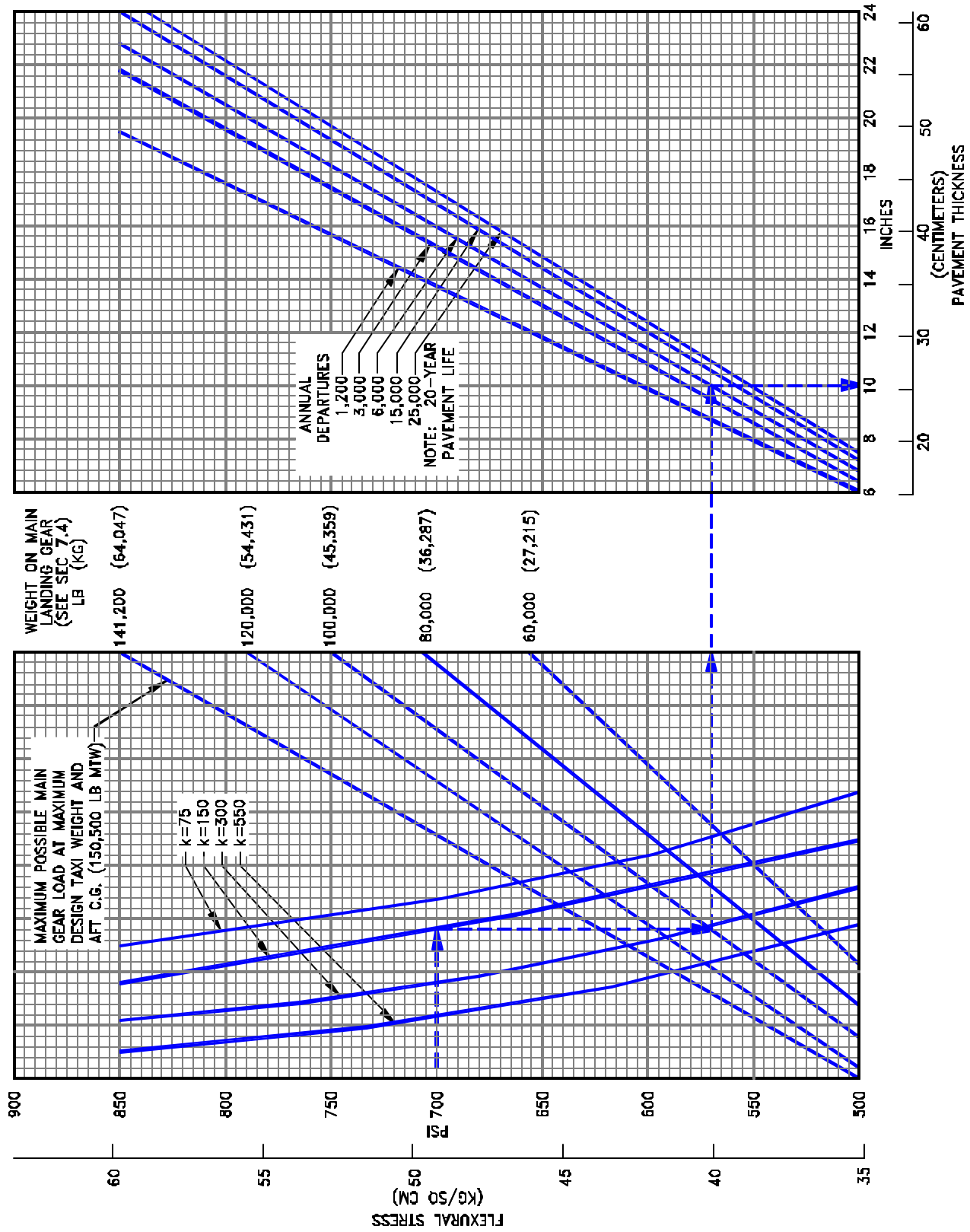

7.9.4 RIGID PAVEMENT REQUIREMENTS - FAA DESIGN METHOD
 MODEL 737-300, -400, -500 (LOW PRESSURE TIRES)

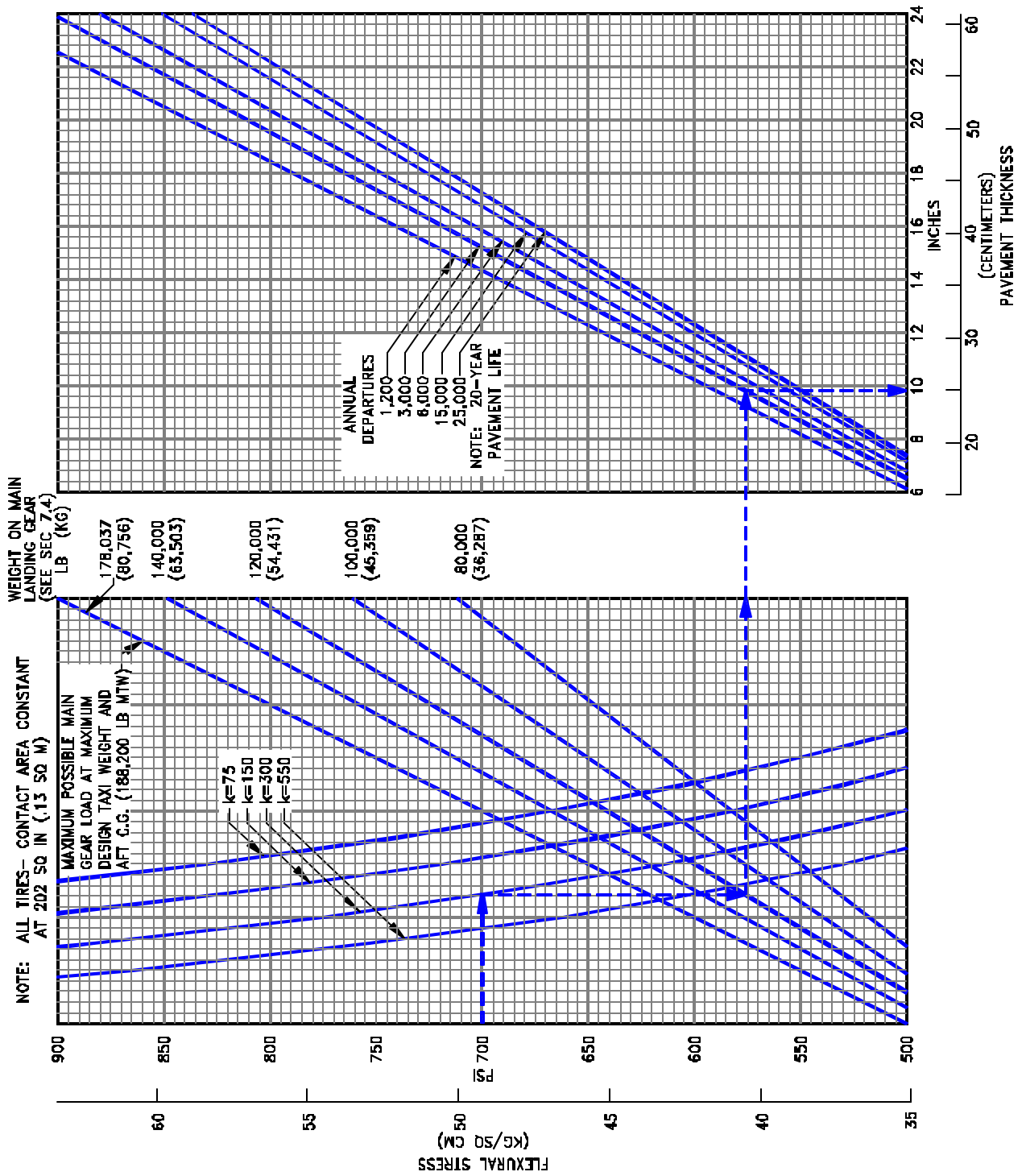

7.9.5 RIGID PAVEMENT REQUIREMENTS - FAA DESIGN METHOD

MODEL 737-600, -700, -800, -900, -900ER WITH AND WITHOUT WINGLETS, 737 BBJ, 737 BBJ2

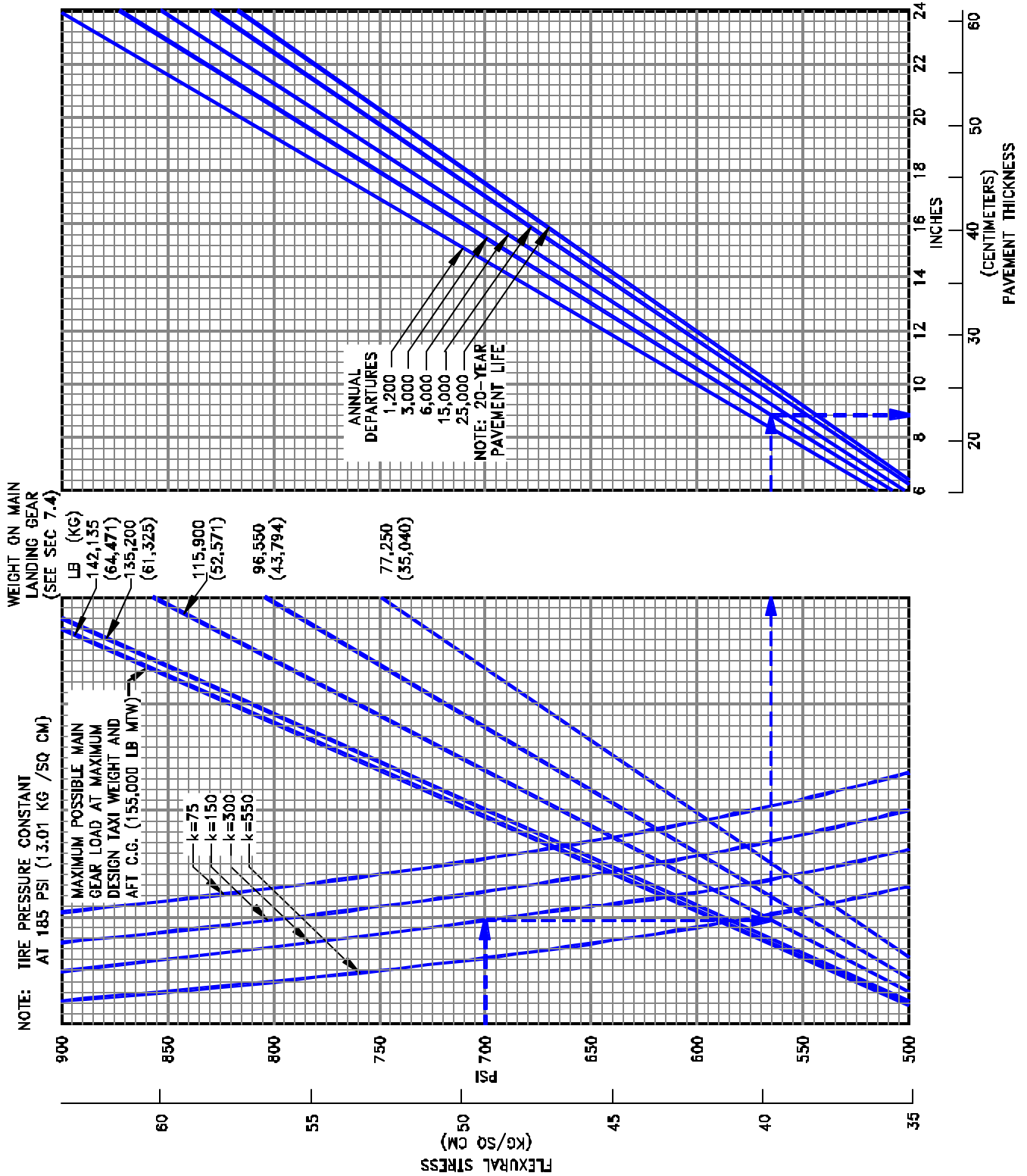

7.9.6 RIGID PAVEMENT REQUIREMENTS - FAA DESIGN METHOD
 MODEL 737-600, -700 (OPTIONAL TIRES)

7.10 ACN/PCN Reporting System: Flexible and Rigid Pavements

To determine the ACN of an aircraft on flexible or rigid pavement, both the aircraft gross weight and the subgrade strength category must be known. In the chart in Section 7.10.1, for an aircraft with gross weight of 80,000 lb and low subgrade strength, the flexible pavement ACN is 19.5. In Section 7.10.20, for the same gross weight and subgrade strength, the rigid pavement ACN is 20.6.

Note: An aircraft with an ACN equal to or less than the reported PCN can operate on that pavement subject to any limitations on the tire pressure.

The following table provides ACN data in tabular format similar to the one used by ICAO in the “Aerodrome Design Manual Part 3, Pavements”. If the ACN for an intermediate weight between maximum taxi weight and the empty weight of the aircraft is required, Figures 7.10.1 through 7.10.38 should be consulted.

AIRCRAFT MODEL	ALL-UP MASS/ OPERATING MASS EMPTY LB (KG)	LOAD ON ONE MAIN GEAR LEG (%)	TIRE PRESSURE PSI (MPa)	ACN FOR RIGID PAVEMENT SUBGRADES – MN/m ³				ACN FOR FLEXIBLE PAVEMENT SUBGRADES – CBR			
				HIGH 150	MEDIUM 80	LOW 40	ULTRA LOW 20	HIGH 15	MEDIUM 10	LOW 6	ULTRA LOW 3
737-100	111,000 (50,349) 62,000 (28,123)	45.95	157 (1.08)	27 14	29 15	31 16	32 17	25 13	26 13	29 14	33 16
737-200	128,600 (58,332) 65,300 (29,620)	45.96	182 (1.25)	34 15	36 16	38 17	39 18	30 14	31 14	35 15	39 17
737-300	140,000 (63,503) 72,540 (32,904)	45.43	201 (1.38)	38 17	40 18	42 19	43 20	33 15	35 16	39 17	43 20
737-400	150,500 (68,266) 74,170 (33,643)	46.91	185 (1.27)	42 18	44 19	47 20	48 21	37 16	39 17	44 18	48 21
737-500	134,000 (60,781) 69,030 (31,311)	46.12	194 (1.33)	37 17	38 18	40 19	42 20	32 15	33 15	37 16	41 19
737-600	145,000 (65,771) 80,200 (36,378)	45.83	182 (1.25)	37 19	39 19	41 21	43 22	33 17	34 17	38 19	44 21
737-600	144,000 (65,317) 80,200 (36,378)	45.83	168 (1.15)	36 18	38 19	40 20	42 22	33 17	34 17	38 18	43 21
737-700	155,000 (70,307) 83,000 (37,648)	45.85	197 (1.36)	41 19	43 20	46 22	47 23	36 18	38 18	42 19	47 22
737-700	155,000 (70,307) 83,000 (37,648)	45.85	179 (1.23)	40 20	42 21	45 22	47 23	36 18	37 18	42 19	47 22
737 BBJ	171,500 (77,790) 100,000 (45,360)	45.86	204 (1.41)	47 25	49 26	52 28	54 29	41 22	43 23	48 24	53 28
737-800	174,700 (79,242) 91,300 (41,413)	46.79	204 (1.41)	49 23	52 24	54 25	56 27	43 20	45 21	50 22	55 26
737 BBJ2	174,700(79,260) 100,000(45,360)	46.79	204 (1.41)	49 24	52 26	54 28	56 30	42 22	45 23	50 25	55 29
737-900	174,700 (79,242) 94,580 (42,901)	46.79	204 (1.41)	49 24	52 25	54 27	56 28	43 21	45 22	50 23	55 27
737-900ER	188,200(85,366) 98,495(44,676)	47.29	220 (1.52)	56 26	58 27	61 29	63 30	48 22	51 23	56 25	61 29

NOTE: VALUES FOR 737-700, -800, -900, -900ER ARE VALID FOR MODELS WITH AND WITHOUT WINGLETS.

NOTES:
 * TIRES - H40 x 14- 6, 22PR, C40 x 14-21 22PR
 * PRESSURE RANGE FROM 138 TO 145 PSI (9.70 TO 10.27 KG/SQ CM)

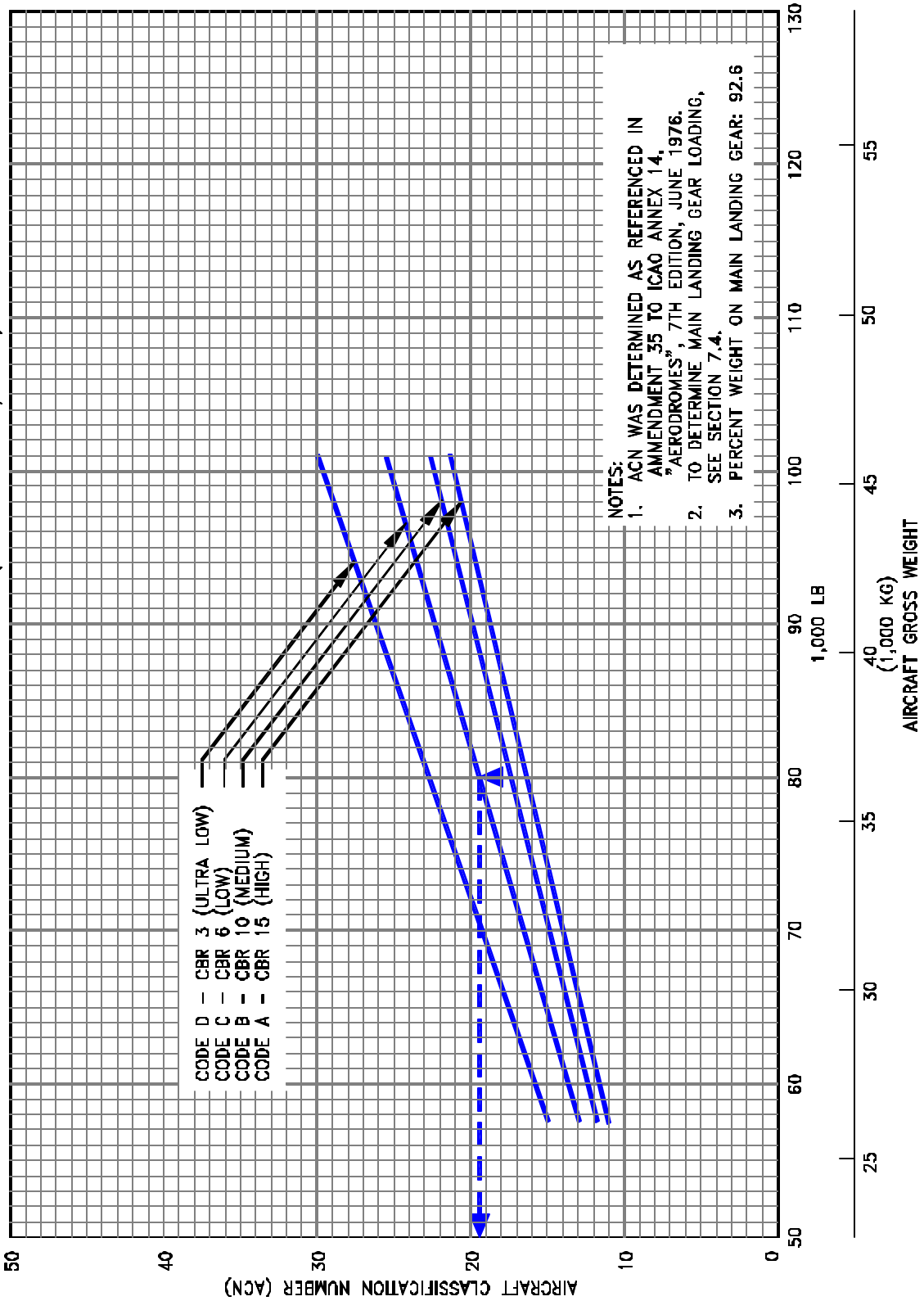

7.10.1 AIRCRAFT CLASSIFICATION NUMBER - FLEXIBLE PAVEMENT
 MODEL 737-100, -200 TO 104,000 LB (47,170 KG) MTW

NOTES:

- * TIRES - H40 x 14-16, 24PR, C40 x 14-21 24PR
- * PRESSURE RANGE FROM 156 TO 168 PSI (10.79 TO 11.81 KG/SQ CM)

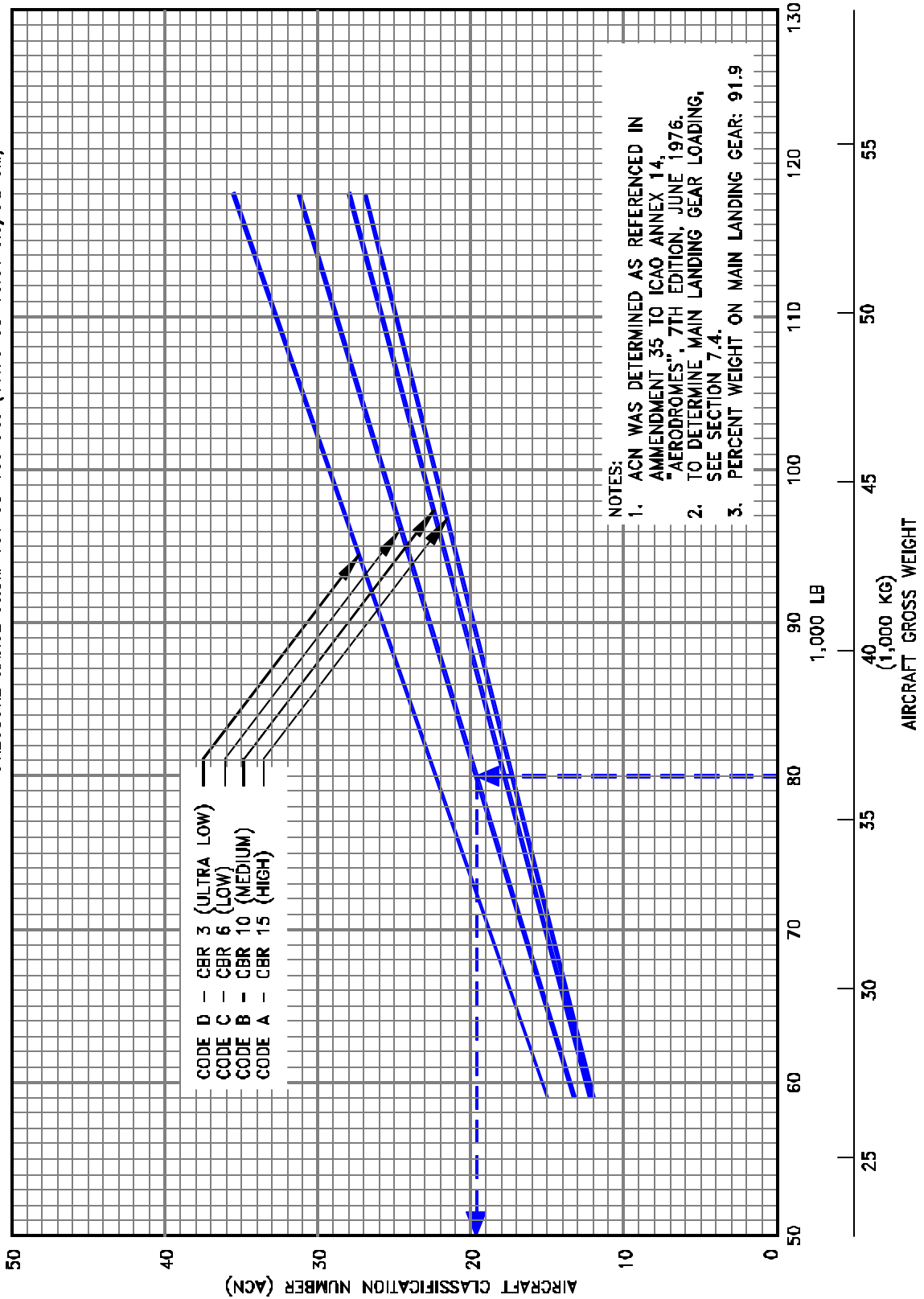

7.10.2 AIRCRAFT CLASSIFICATION NUMBER - FLEXIBLE PAVEMENT

MODEL 737-100, -200, ADV 737-200 AT 110,000 TO 117,500 LB (49,900 TO 53,290 KG) MTW

NOTES:
 * TIRES - C40 x 18-17 20PR
 * PRESSURE AT 95 OR 96 PSI (16.68 OR 6.75 KG/SQ CM)

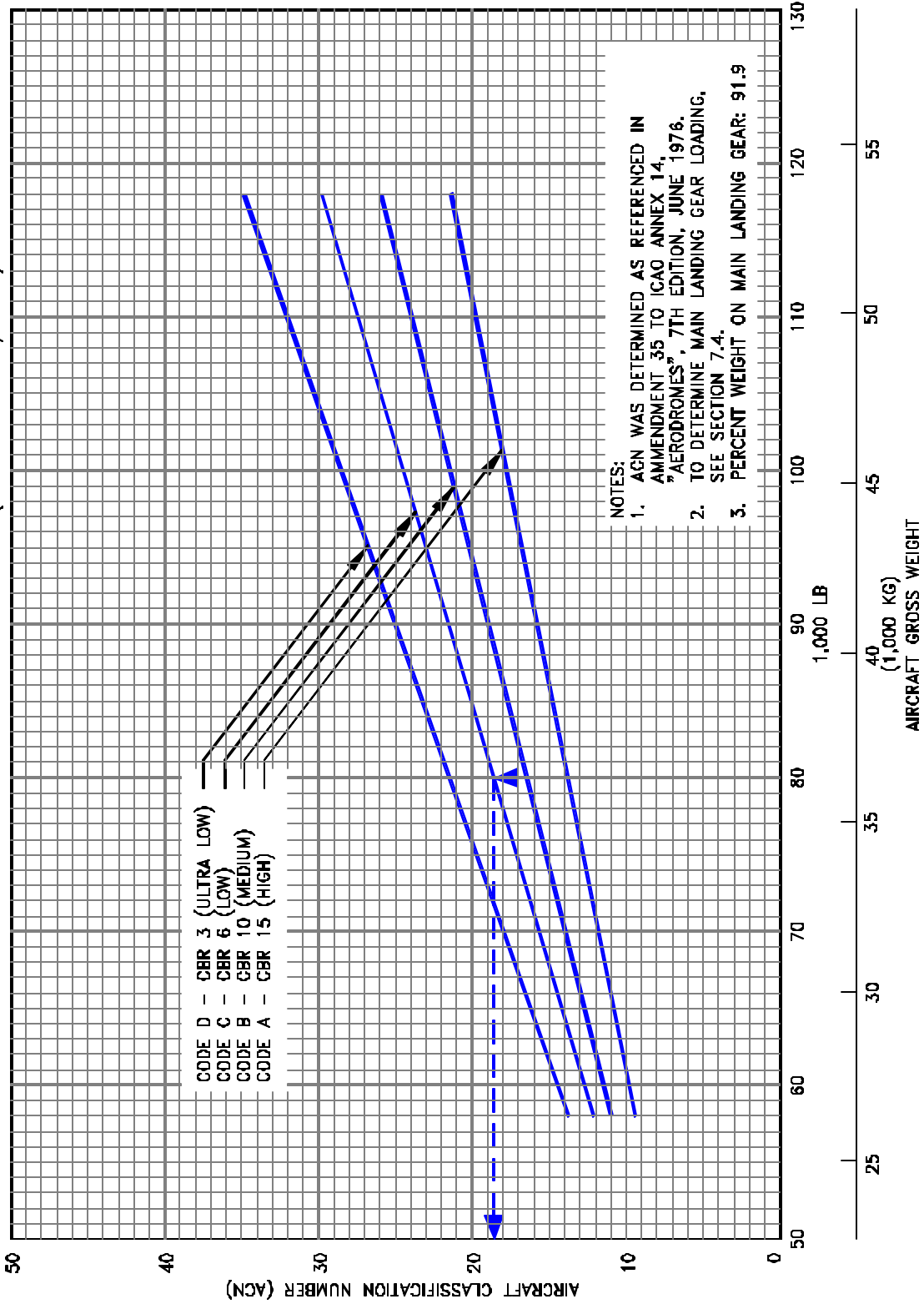

NOTES:
 1. ACN WAS DETERMINED AS REFERENCED IN AMENDMENT 35 TO ICAO ANNEX 14, "AERODROMES", 7TH EDITION, JUNE 1976.
 2. TO DETERMINE MAIN LANDING GEAR LOADING, SEE SECTION 7.4.
 3. PERCENT WEIGHT ON MAIN LANDING GEAR: 91.9

7.10.3 AIRCRAFT CLASSIFICATION NUMBER - FLEXIBLE PAVEMENT
 MODEL 737-100, -200, ADV 737-200 AT 110,000 TO 117,500 LB (49,900 TO 53,290 KG) MTW
 (LOW PRESSURE TIRES)

NOTES:
 * TIRES - 40 x 14-16 24PR; C40 x 14-21 24PR OR 26PR; H40 x 14.5-19 24PR
 * PRESSURE RANGE FROM 170 TO 181 PSI (11.95 TO 12.80 KG/SQ CM)

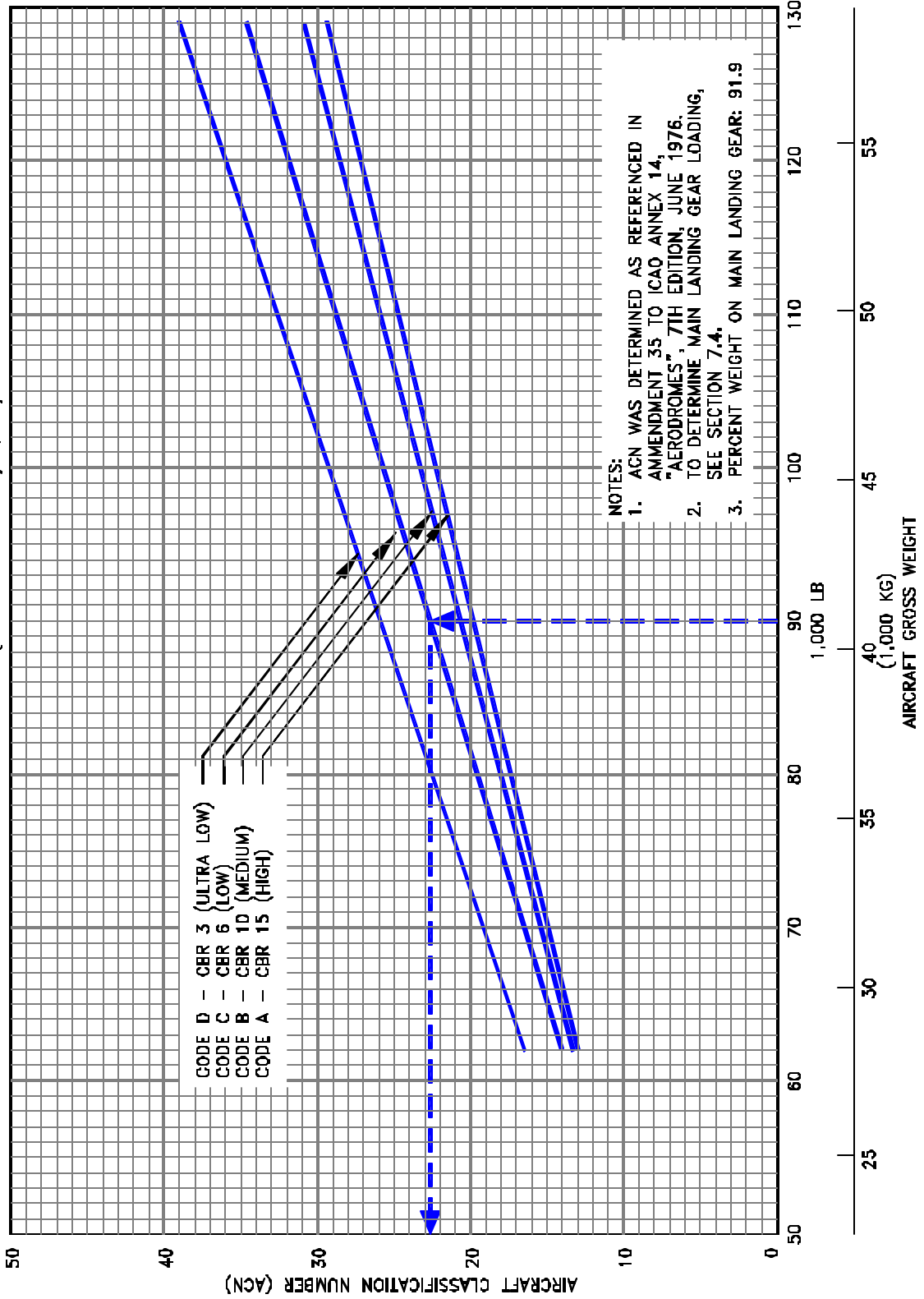

7.10.4 AIRCRAFT CLASSIFICATION NUMBER - FLEXIBLE PAVEMENT
 MODEL ADV 737-200 AT 120,000 TO 128,600 LB (54,3000 TO 58,330 KG) MTW

NOTES:
 * TIRES - H40 x 14.5-19 24PR

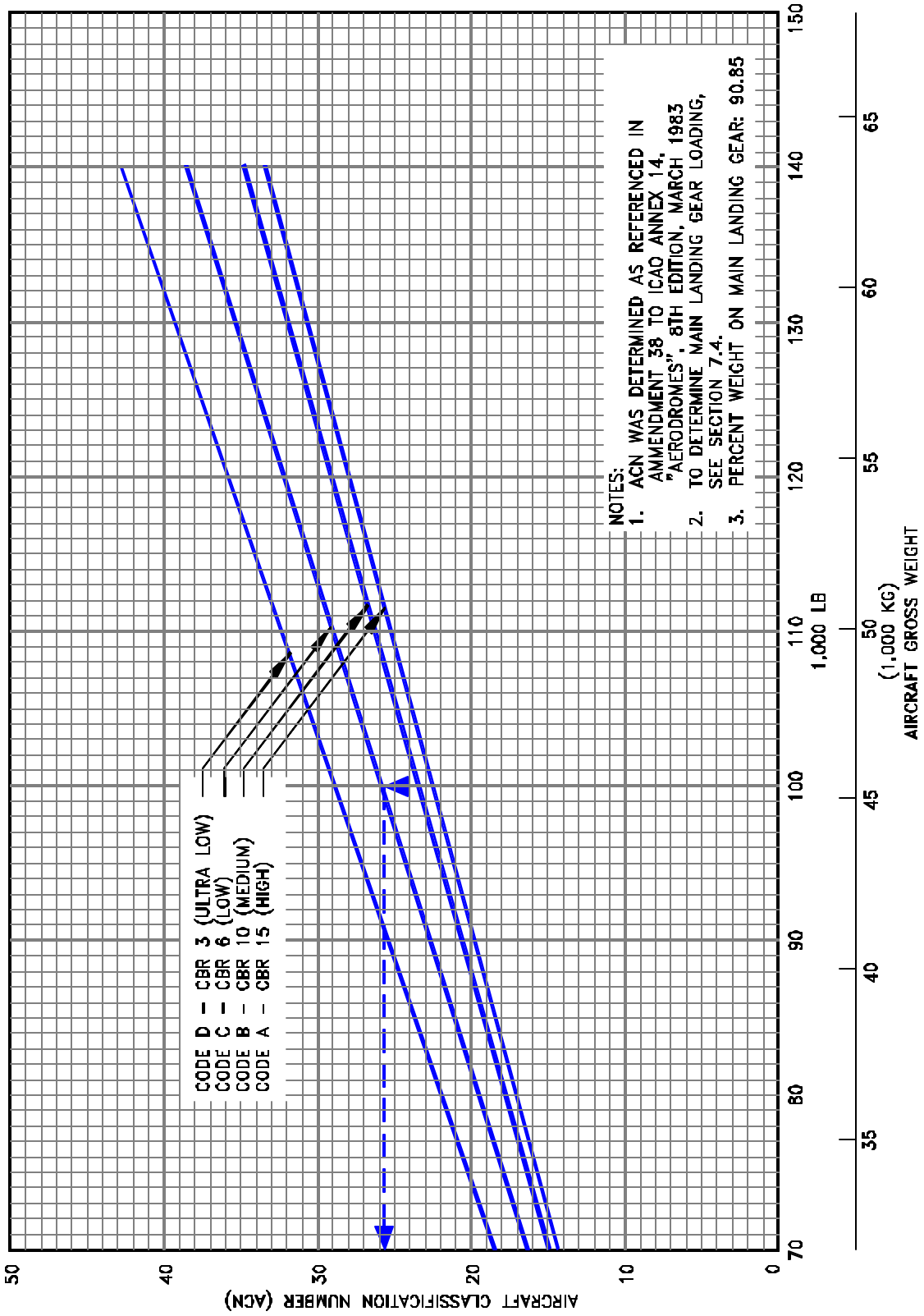

7.10.5 AIRCRAFT CLASSIFICATION NUMBER - FLEXIBLE PAVEMENT
 MODEL 737-300

NOTES:
* TIRES - H42 x 16-19 24PR

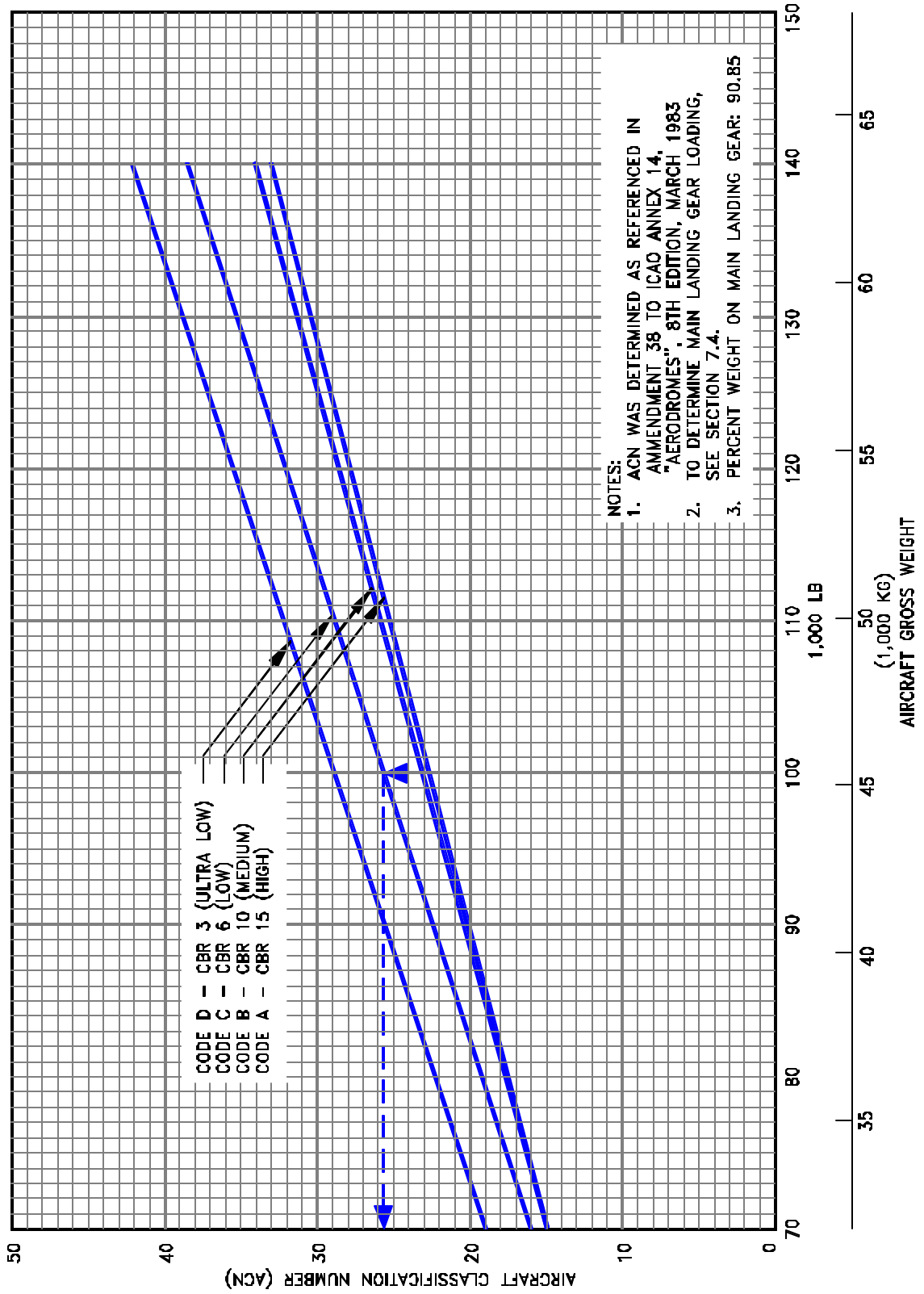

7.10.6 AIRCRAFT CLASSIFICATION NUMBER - FLEXIBLE PAVEMENT
MODEL 737-300 (LOW PRESSURE TIRES)

NOTES:
* TIRES - H42 x 16-19 26PR

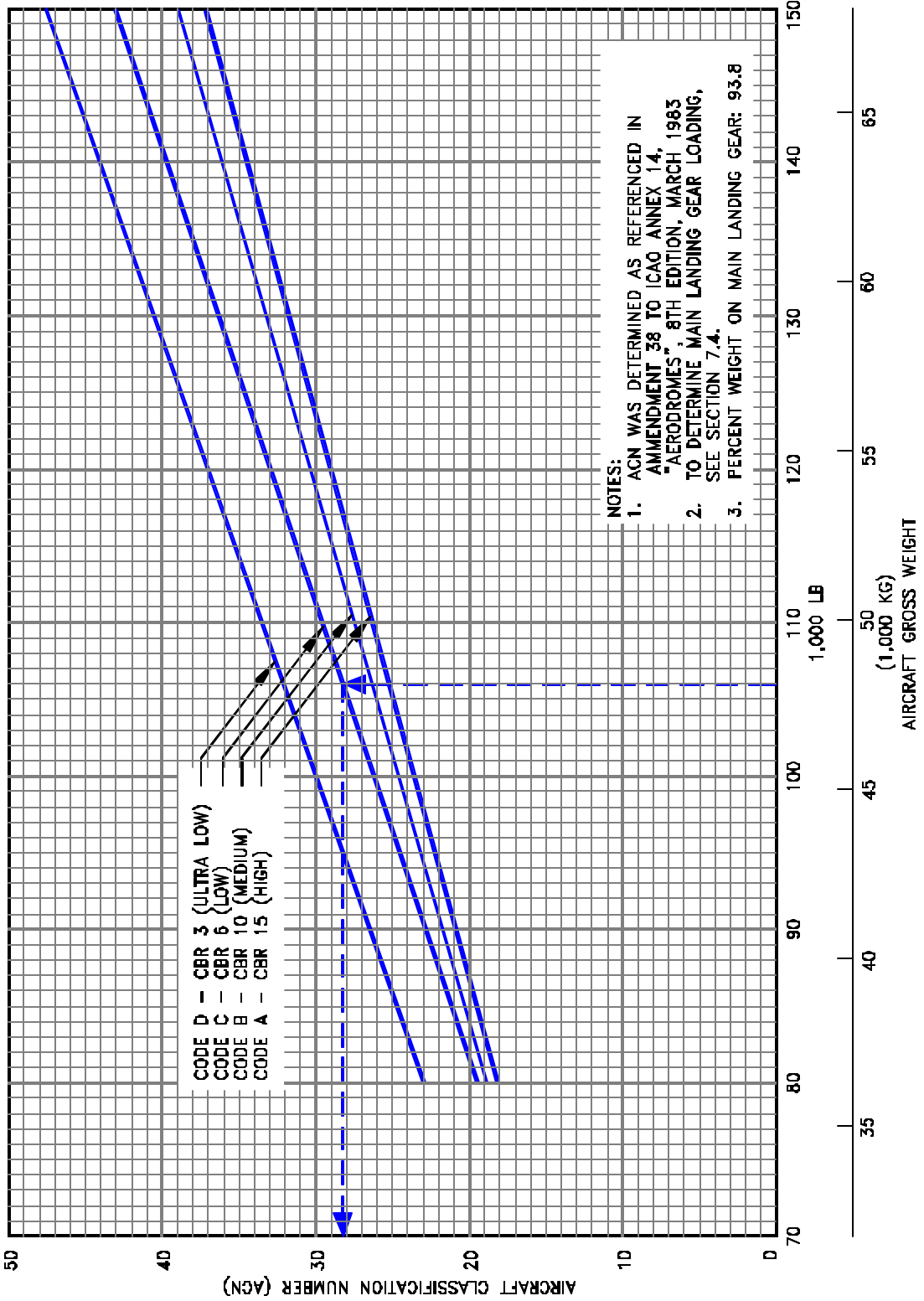

NOTES:
1. ACN WAS DETERMINED AS REFERENCED IN AMMENDMENT 38 TO ICAO ANNEX 14, "AERODROMES", 8TH EDITION, MARCH 1963 TO DETERMINE MAIN LANDING GEAR LOADING, SEE SECTION 7.4.
3. PERCENT WEIGHT ON MAIN LANDING GEAR: 93.8

7.10.7 AIRCRAFT CLASSIFICATION NUMBER - FLEXIBLE PAVEMENT
MODEL 737-400

NOTES:
* TIRES - H42 x 16-19 24PR

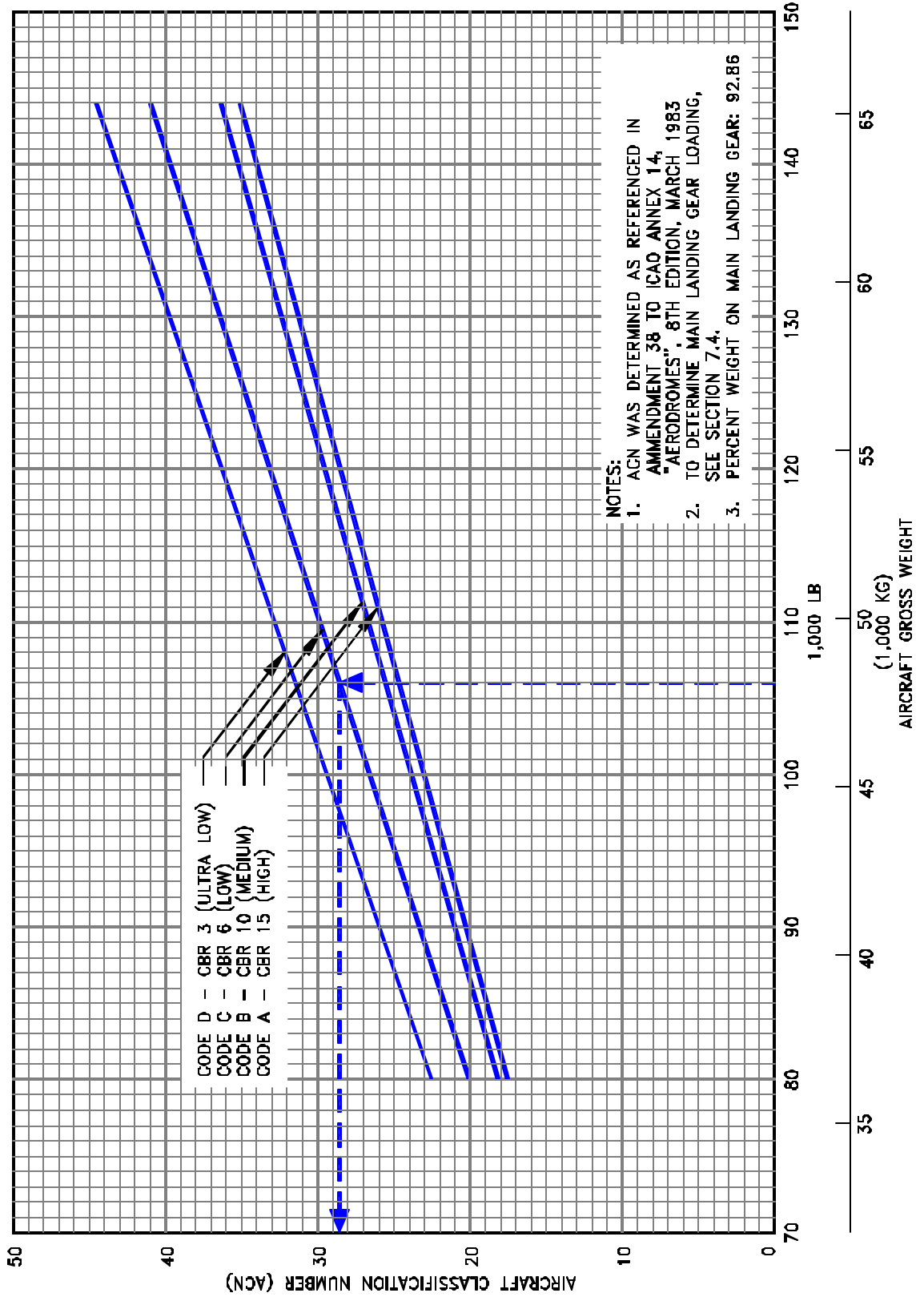

NOTES:
1. ACN WAS DETERMINED AS REFERENCED IN AMMENDMENT 38 TO ICAO ANNEX 14, "AERODROMES", 8TH EDITION, MARCH, 1983
2. TO DETERMINE MAIN LANDING GEAR LOADING, SEE SECTION 7.4.
3. PERCENT WEIGHT ON MAIN LANDING GEAR: 92.86

7.10.8 AIRCRAFT CLASSIFICATION NUMBER - FLEXIBLE PAVEMENT
MODEL 737-400 (LOW PRESSURE TIRES)

NOTES:
* TIRES -- H40 x 14.5-19 24PR

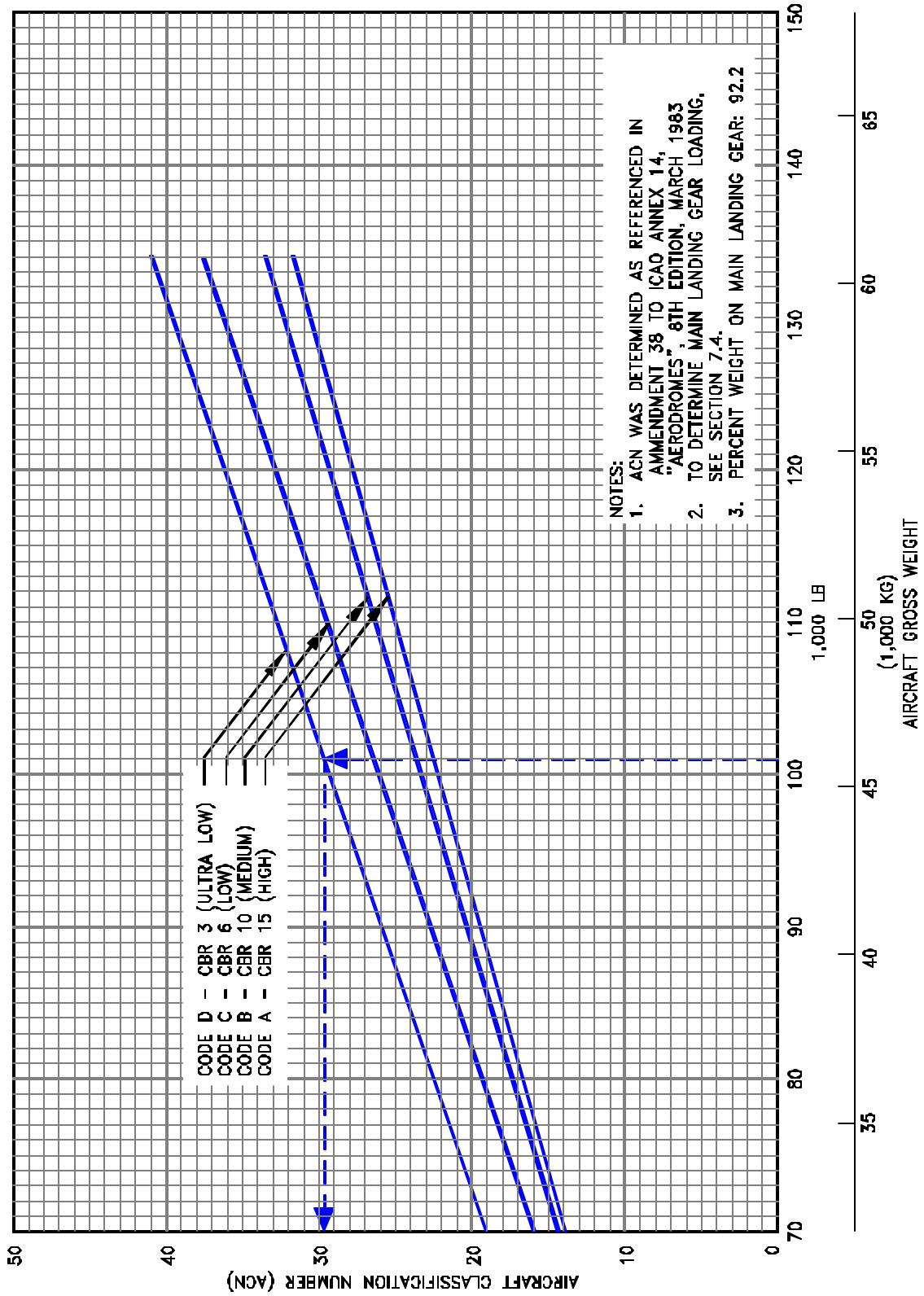

7.10.9 AIRCRAFT CLASSIFICATION NUMBER - FLEXIBLE PAVEMENT
 MODEL 737-500

NOTES:
 * TIRES - H42 x 16-19 24PR

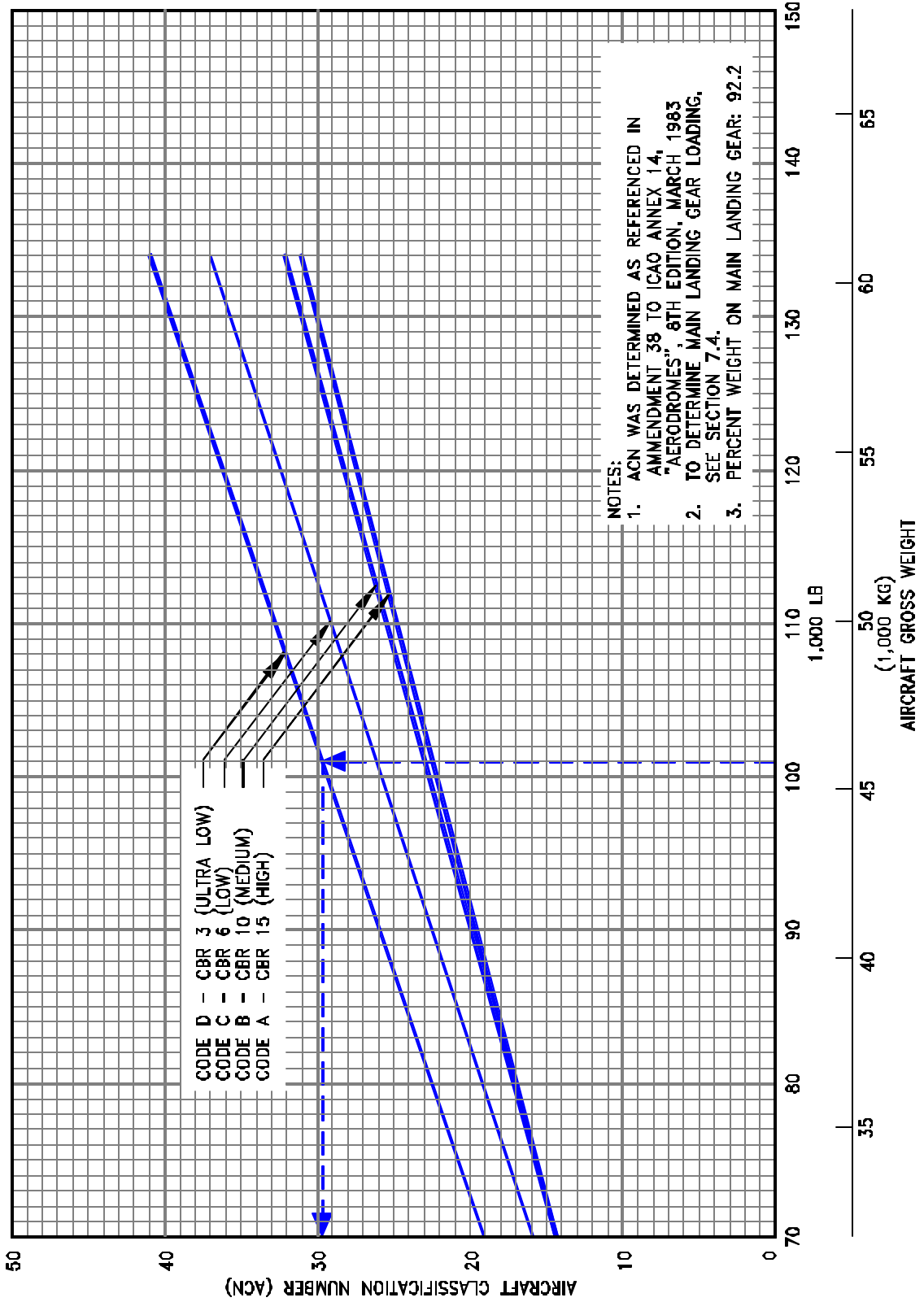

7.10.10 AIRCRAFT CLASSIFICATION NUMBER - FLEXIBLE PAVEMENT
 MODEL 737-500 (LOW PRESSURE TIRES)

NOTES:
 * TIRES - H43.5 x 16.0 - 21, 24PR OR 26PR
 * PRESSURE - 182 PSI (12.80 KG/5Q CM)

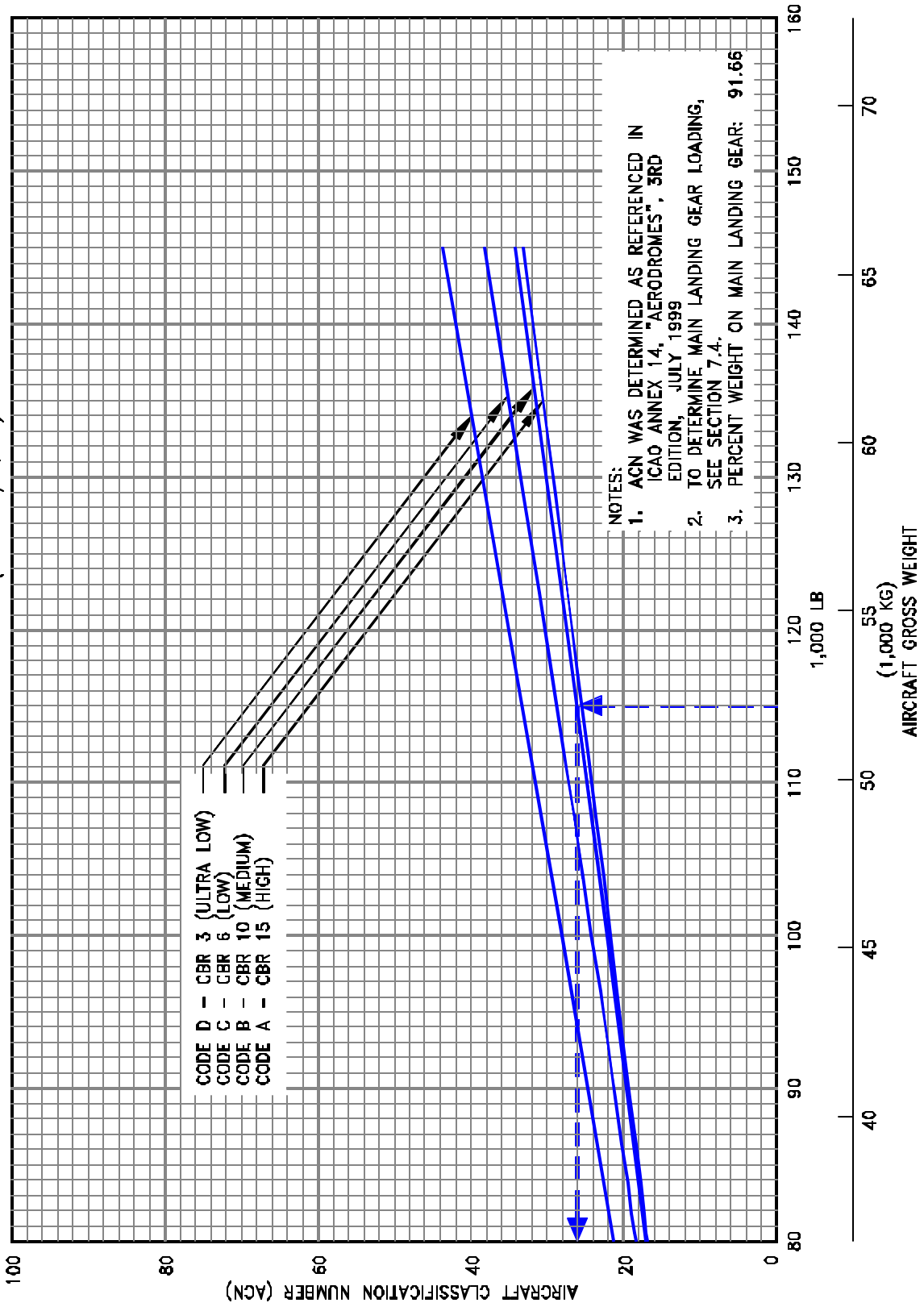

7.10.11 AIRCRAFT CLASSIFICATION NUMBER - FLEXIBLE PAVEMENT
 MODEL 737-600

NOTES:
 * TIRES - H44.5 x 16.0 - 21, 28PR
 * PRESSURE - 168 PSI (11.81 KG/SQ CM)

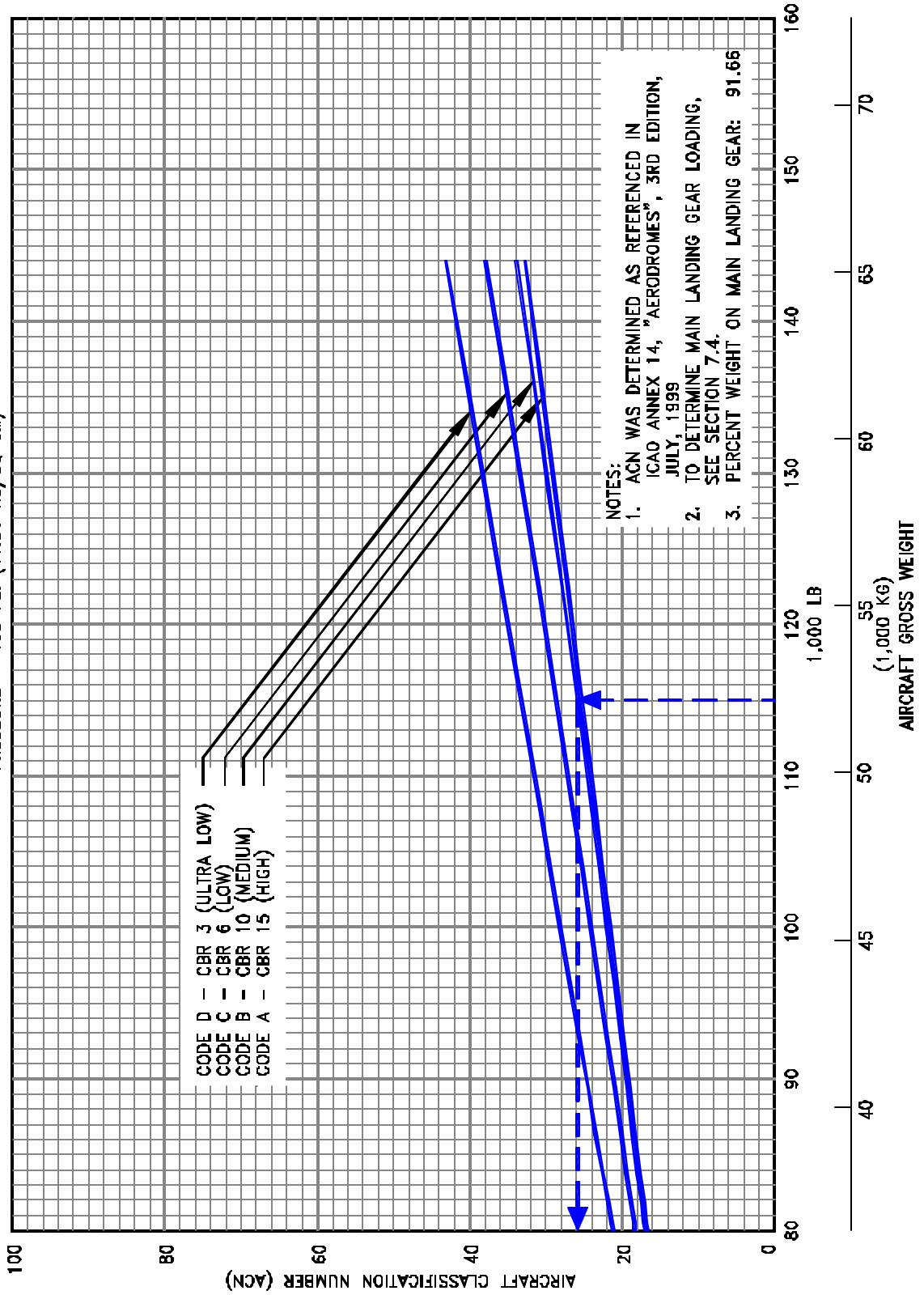

7.10.12 AIRCRAFT CLASSIFICATION NUMBER - FLEXIBLE PAVEMENT
 MODEL 737-600 (OPTIONAL TIRES)

NOTES:
 * TIRES - H43.5 x 16.0 - 21, 26PR
 * PRESSURE - 197 PSI (13.85KG/SQ CM)

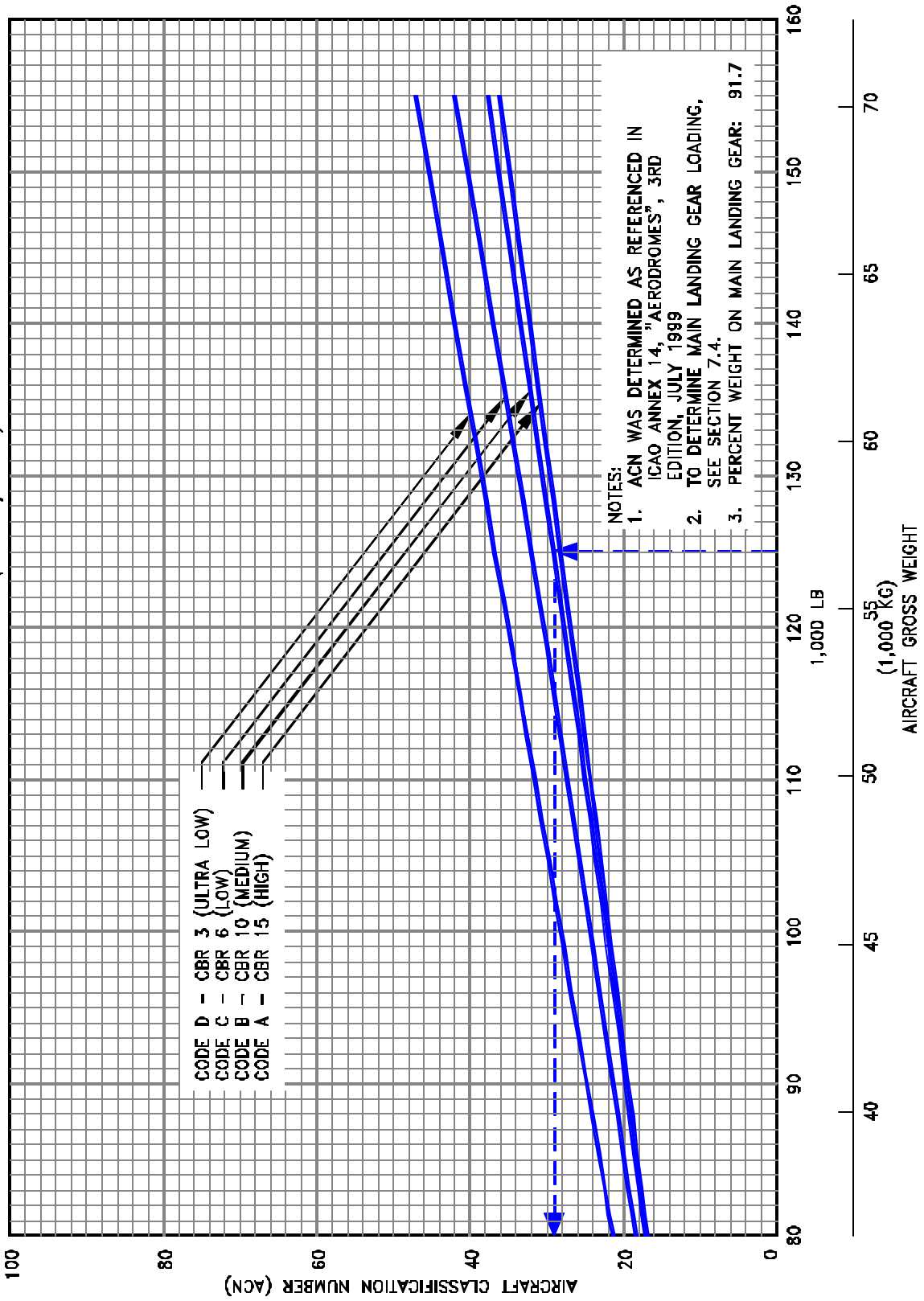

7.10.13 AIRCRAFT CLASSIFICATION NUMBER - FLEXIBLE PAVEMENT
 MODEL 737-700 WITH AND WITHOUT WINGLETS

NOTES:
 * TIRES - H44.5 x 16.5 - 21 28PR
 * PRESSURE - 179 PSI (12.59 KG/SQ CM)

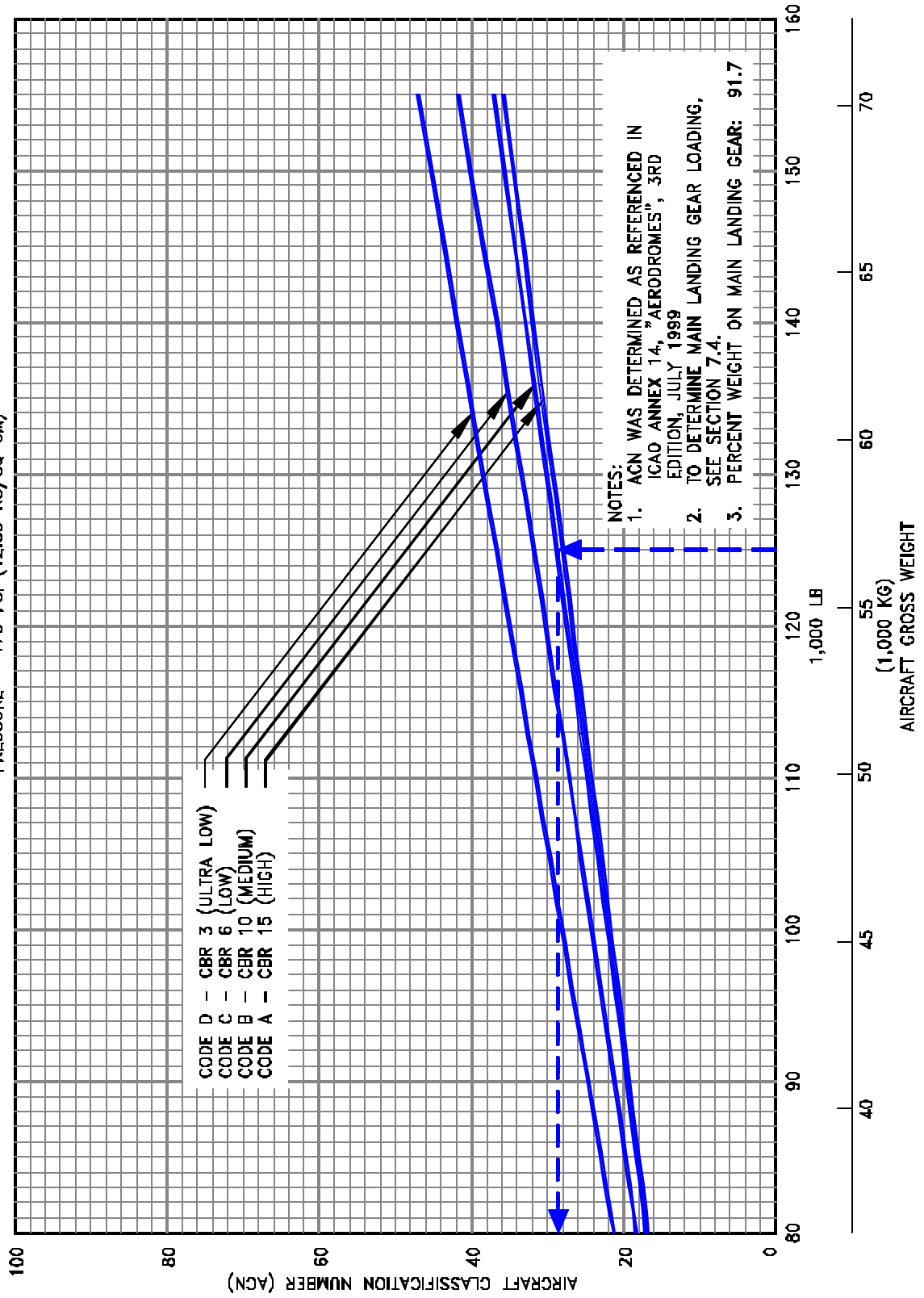

7.10.14 AIRCRAFT CLASSIFICATION NUMBER - FLEXIBLE PAVEMENT
 MODEL 737-700 (OPTIONAL TIRES) WITH AND WITHOUT WINGLETS

NOTES:
 * TIRES - H44.5 x 16.5 - 21, 28PR
 * PRESSURE - 204 PSI (14.34 KG/SQ CM)

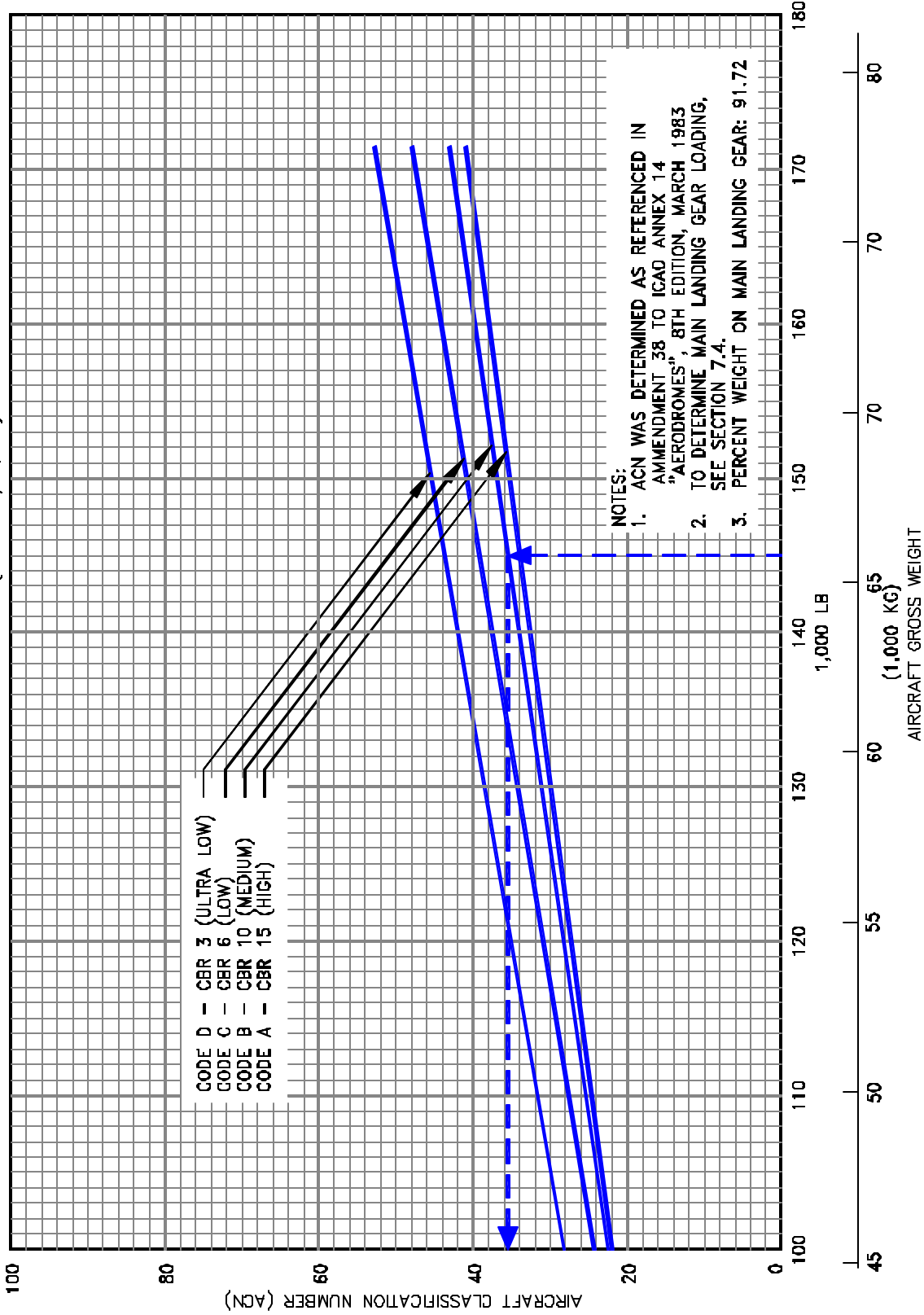

7.10.15 AIRCRAFT CLASSIFICATION NUMBER - FLEXIBLE PAVEMENT
 MODEL 737 BBJ

NOTES:
 * TIRES - H44.5 x 16.5 - 21, 28PR
 * PRESSURE - 204 PSI (14.34 KG/50 CM)

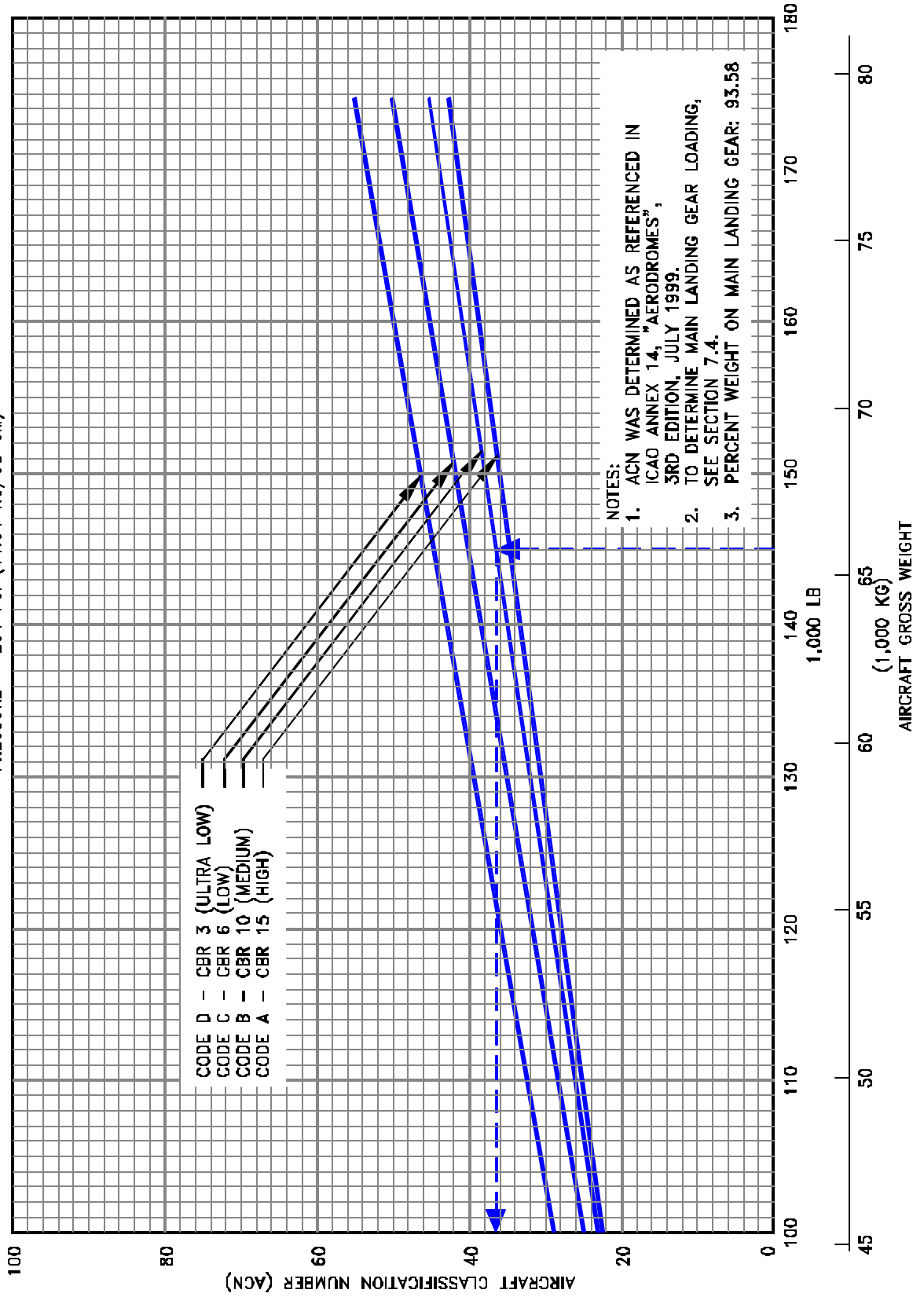

7.10.16 AIRCRAFT CLASSIFICATION NUMBER - FLEXIBLE PAVEMENT
 MODEL 737-800 WITH AND WITHOUT WINGLETS

NOTES:
 * TIRES - H44.5 x 16.5 - 21, 28PR
 * PRESSURE - 204 PSI (14.34 KG/SQ CM)

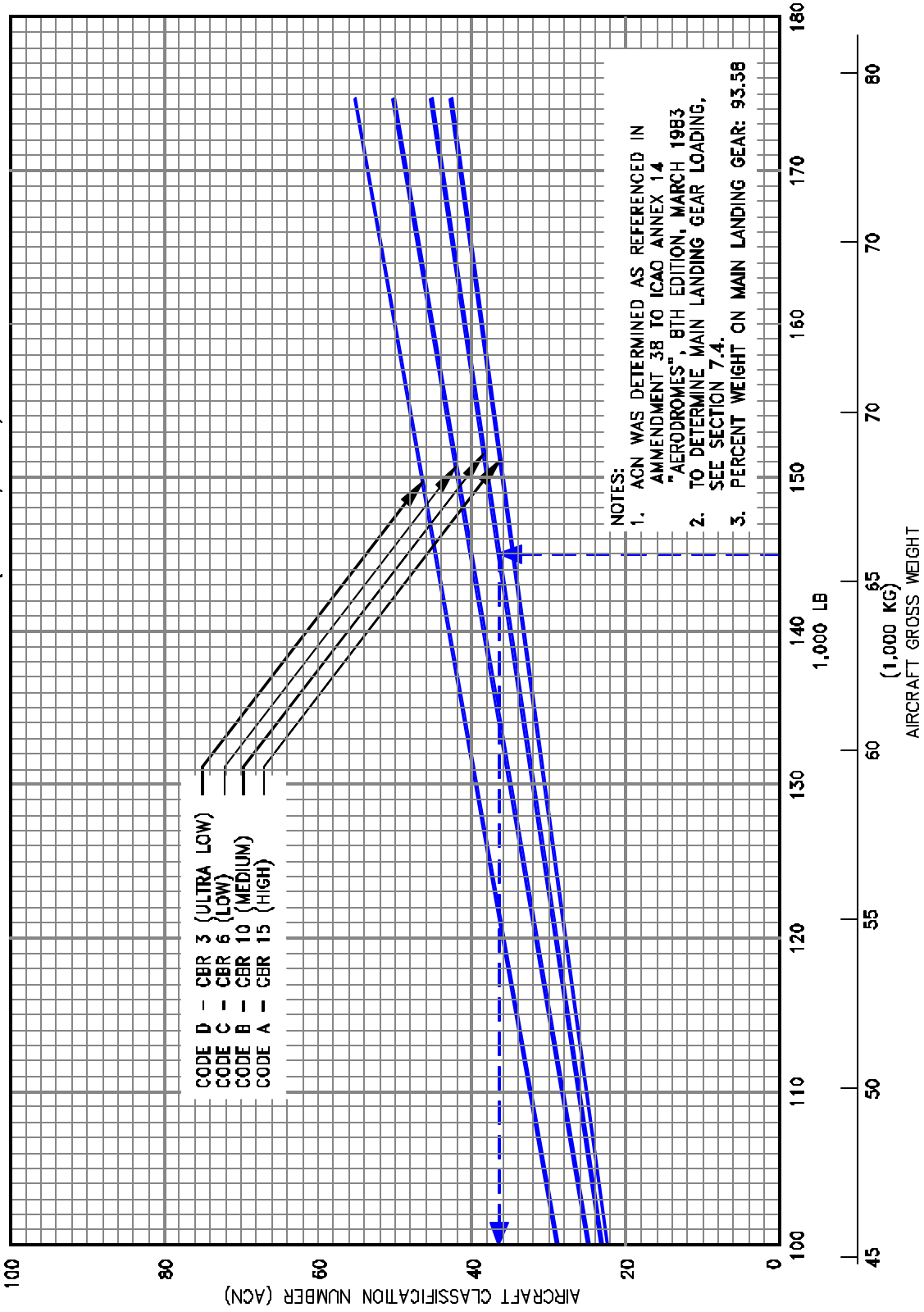

7.10.17 AIRCRAFT CLASSIFICATION NUMBER - FLEXIBLE PAVEMENT
 MODEL 737 BBJ2

NOTES:
 * TIRES - H44.5 x 16.5 - 21, 28PR
 * PRESSURE - 204 PSI (14.34 KG/SQ CM)

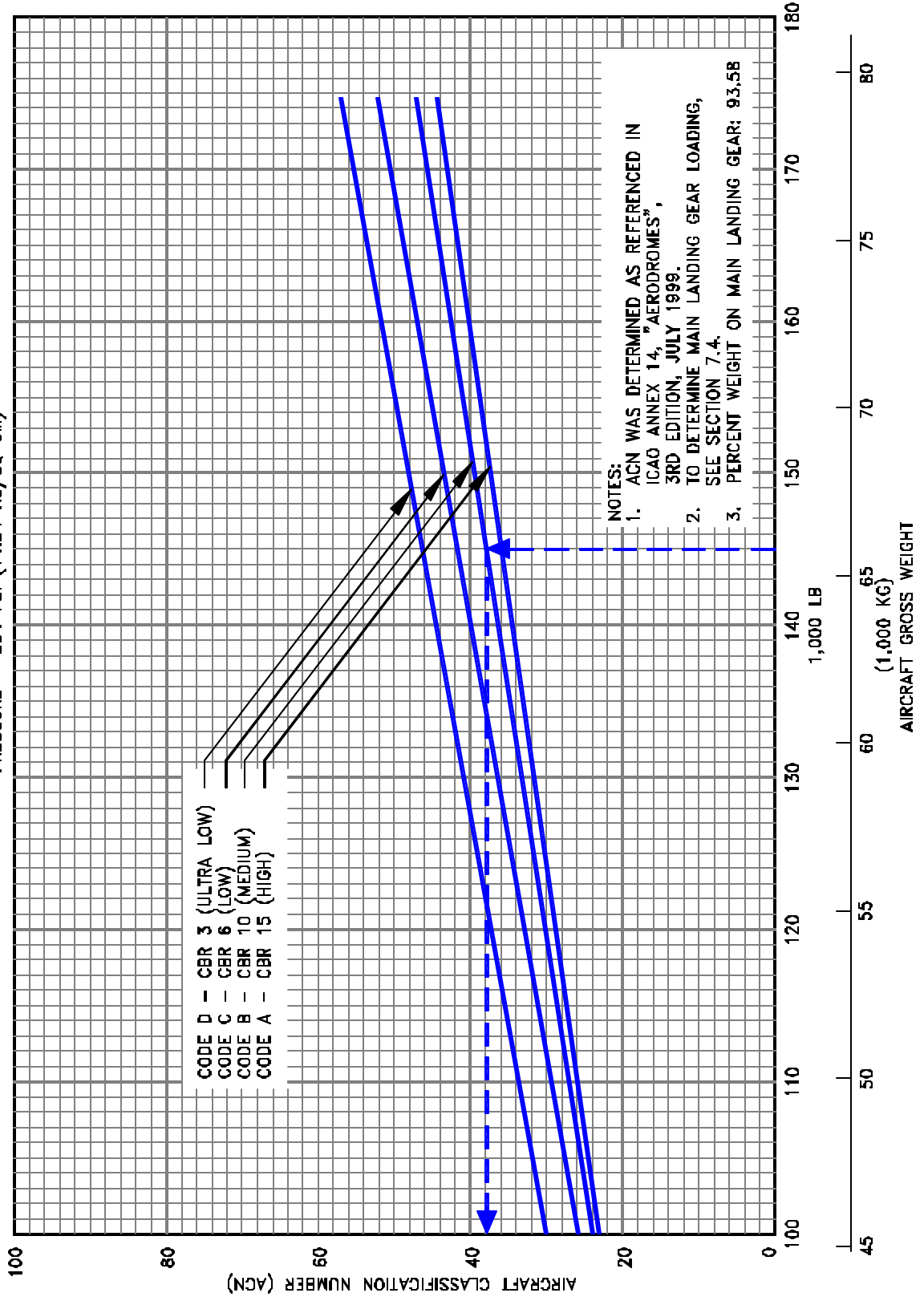

7.10.18 AIRCRAFT CLASSIFICATION NUMBER - FLEXIBLE PAVEMENT
 MODEL 737-900 WITH AND WITHOUT WINGLETS

PRELIMINARY INFORMATION

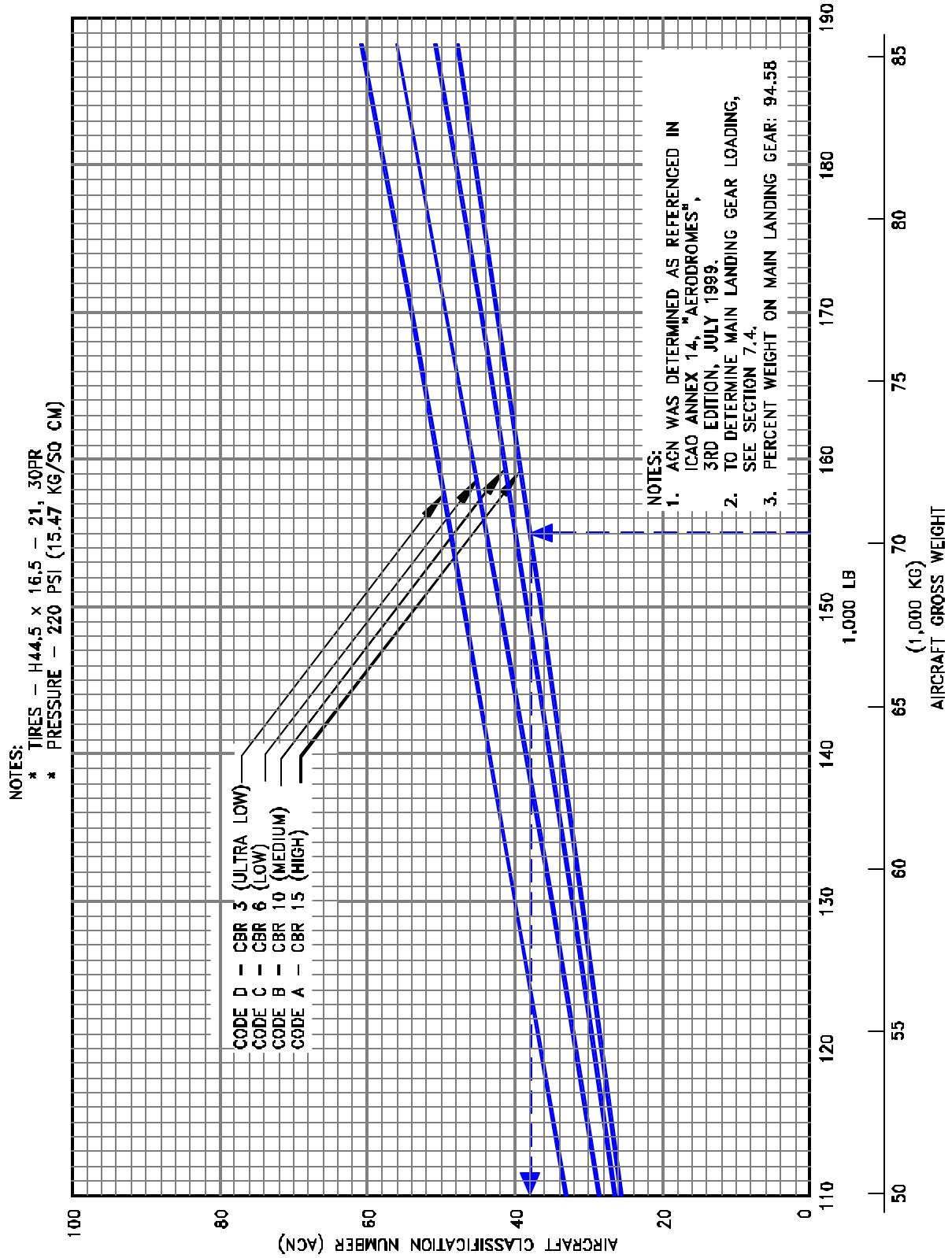

7.10.19 AIRCRAFT CLASSIFICATION NUMBER - FLEXIBLE PAVEMENT MODEL 737-900ER, -900ER WITH WINGLETS

NOTES:
 * TIRES - 40 x 14-16 22PR; C40 x 14-21 22PR
 * PRESSURE RANGE FROM 130 TO 146 PSI (9.70 TO 10.27 KG/SQ CM)

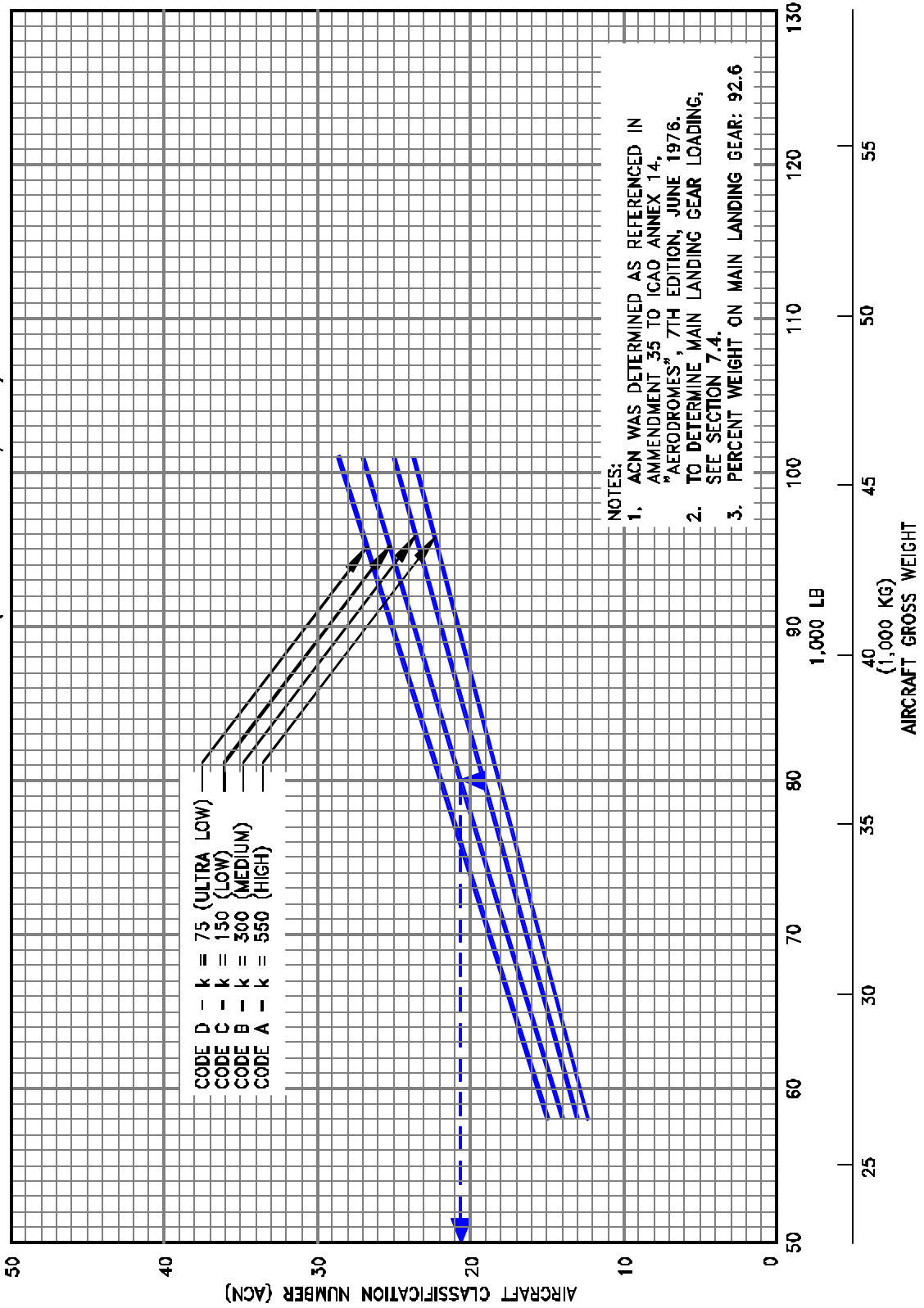

NOTES:
 1. ACN WAS DETERMINED AS REFERENCED IN AMENDMENT 35 TO ICAD ANNEX 14, "AERODROMES", 7TH EDITION, JUNE 1976.
 2. TO DETERMINE MAIN LANDING GEAR LOADING, SEE SECTION 7.4.
 3. PERCENT WEIGHT ON MAIN LANDING GEAR: 92.6

7.10.20 AIRCRAFT CLASSIFICATION NUMBER - RIGID PAVEMENT
 MODEL 737-100, -200 TO 104,000 LB (47,170 KG) MTW

NOTES:
 * TIRES - 40 x 14-16 24PR; C40 x 14-21 24PR
 * PRESSURE RANGE FROM 156 TO 168 PSI (10.97 TO 11.81 KG/SQ CM)

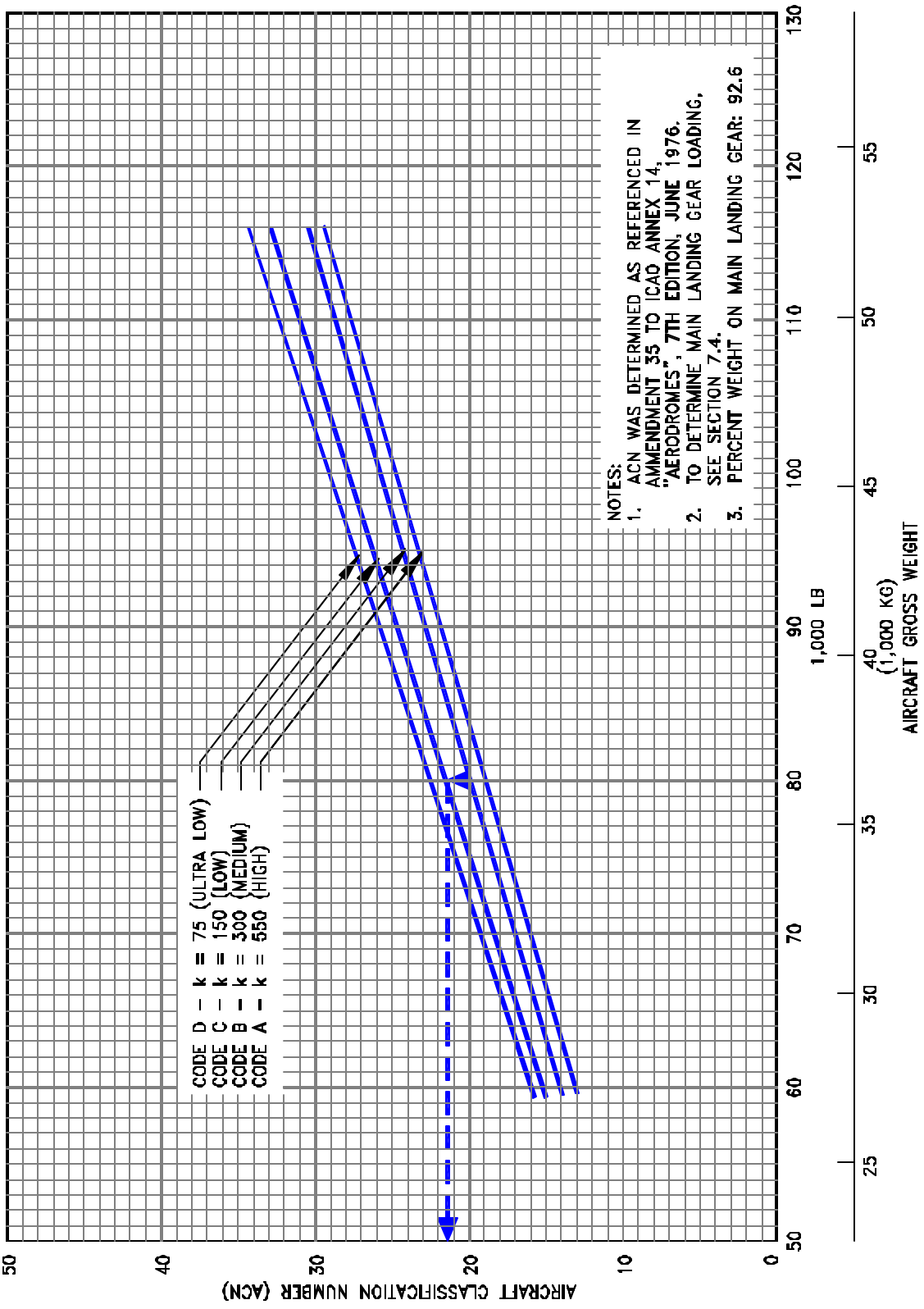

7.10.21 AIRCRAFT CLASSIFICATION NUMBER - RIGID PAVEMENT
 MODEL 737-100, -200, ADV 737-200 AT 110,000 TO 117,500 LB (49,900 TO 53,290 KG) MTW

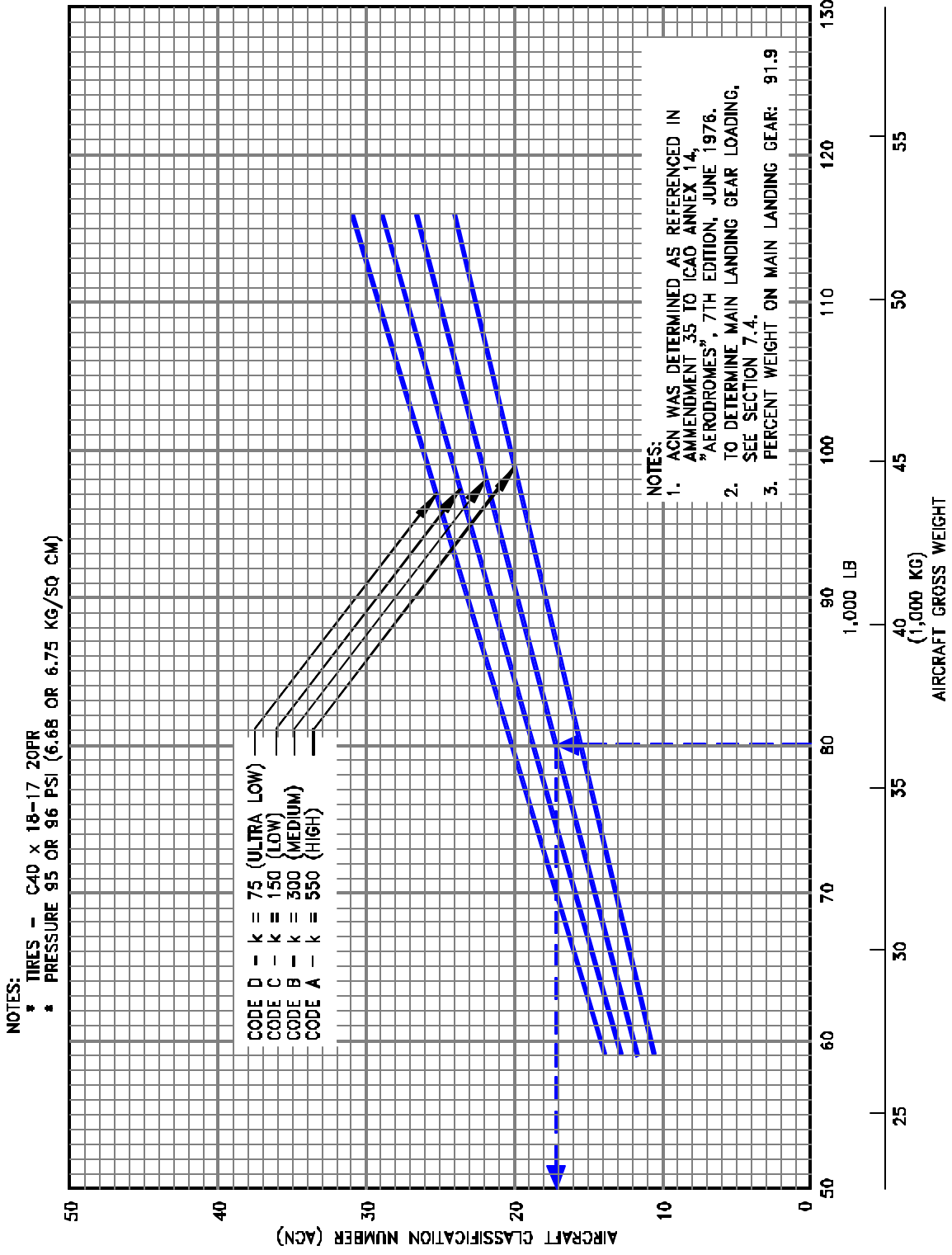

7.10.22 AIRCRAFT CLASSIFICATION NUMBER - RIGID PAVEMENT
 MODEL 737-100, -200, ADV 737-200 AT 110,000 TO 117,500 LB (49,900 TO 53,290 KG) MTW
 (LOW PRESSURE TIRES)

NOTES:
 * TIRES - 40 x 14-16 24PR; C40 x 14-21 24PR OR 26PR; H40 x 14.5-19 24PR
 * PRESSURE RANGE FROM 170 TO 181 PSI (11.95 TO 12.80 KG/SQ CM)

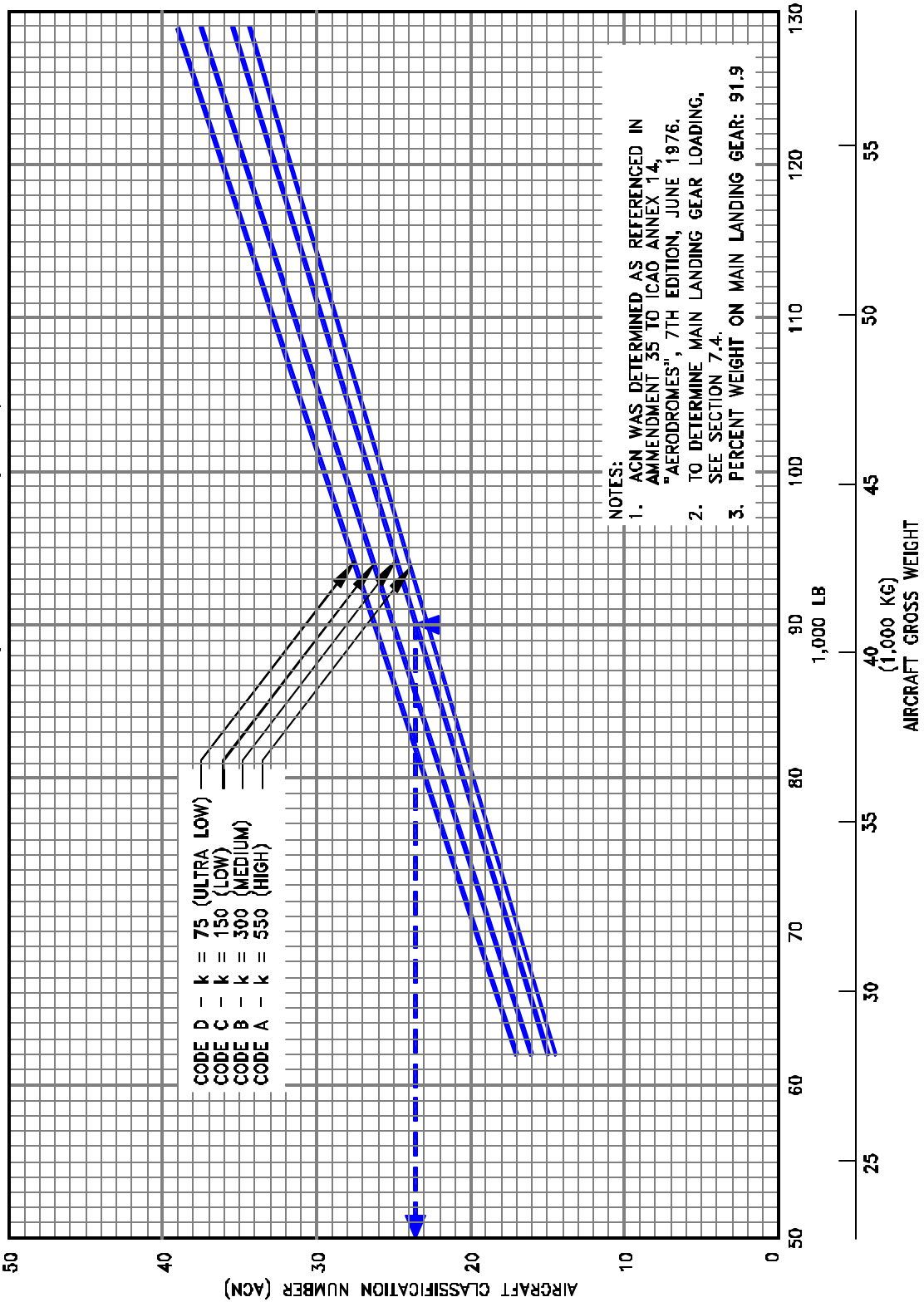

7.10.23 AIRCRAFT CLASSIFICATION NUMBER - RIGID PAVEMENT
 MODEL ADV 737-200 AT 120,000 TO 128,600 LB (54,300 TO 58,330 KG) MTW

NOTES:
 * TIRES -- H40 x 14.5-19 24PR

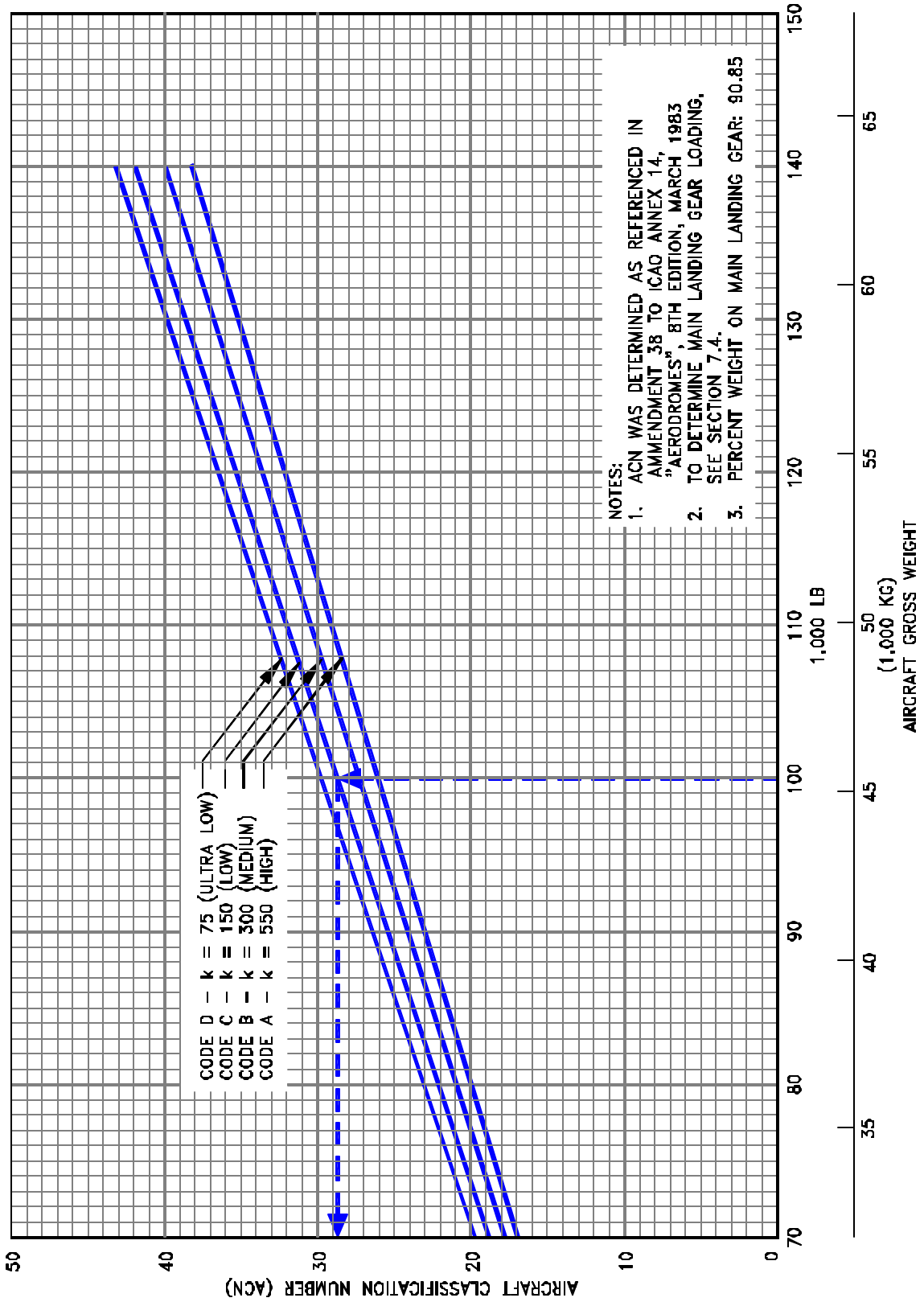

7.10.24 AIRCRAFT CLASSIFICATION NUMBER - RIGID PAVEMENT
 MODEL 737-300

NOTES:
* TIRES — H42 x 16-19 24PR

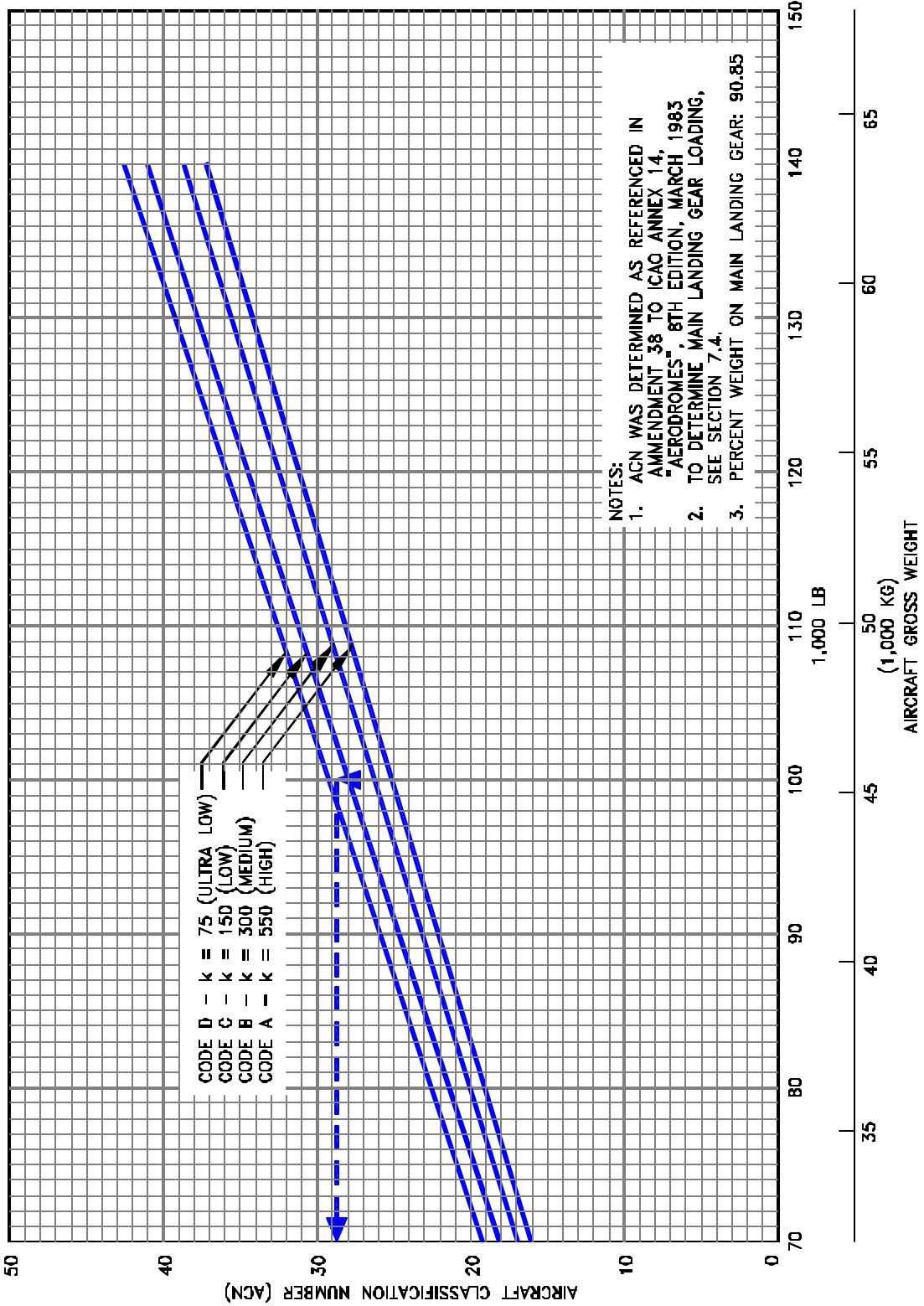

7.10.25 AIRCRAFT CLASSIFICATION NUMBER - RIGID PAVEMENT
MODEL 737-300 (LOW PRESSURE TIRES)

NOTES:
* TIRES — H42 x 16-19 26PR

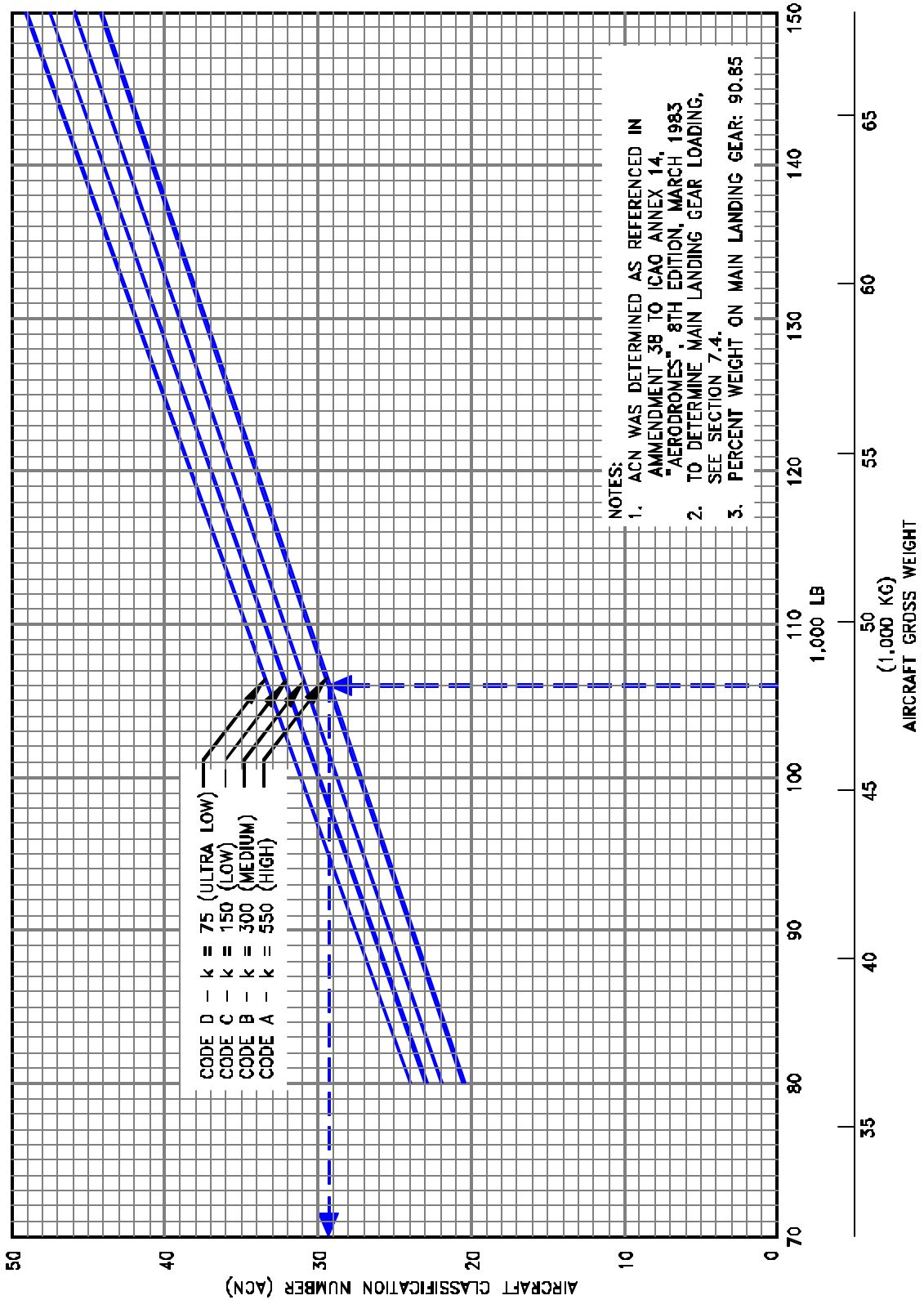

7.10.26 AIRCRAFT CLASSIFICATION NUMBER - RIGID PAVEMENT
MODEL 737-400

NOTES:
 * TIRES -- H42 x 16-19 24PR

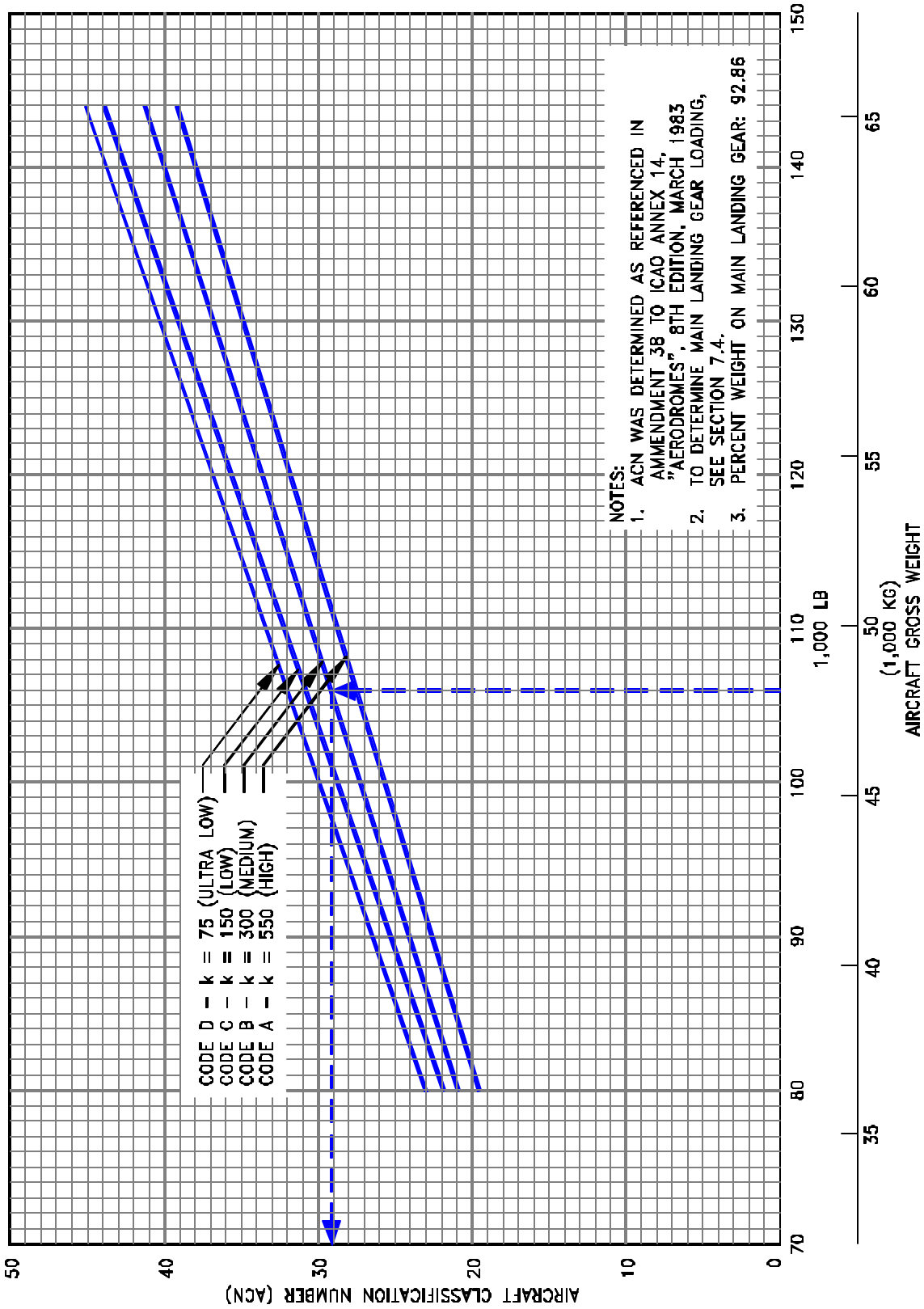

NOTES:
 1. ACN WAS DETERMINED AS REFERENCED IN AMMENDMENT 38 TO ICAO ANNEX 14, "AERODROMES", 8TH EDITION, MARCH 1985
 2. TO DETERMINE MAIN LANDING GEAR LOADING, SEE SECTION 7.4.
 3. PERCENT WEIGHT ON MAIN LANDING GEAR: 92.86

7.10.27 AIRCRAFT CLASSIFICATION NUMBER - RIGID PAVEMENT
 MODEL 737-400 (LOW PRESSURE TIRES)

NOTES:
 * TIRES - H40 x 14.5-19 24PR

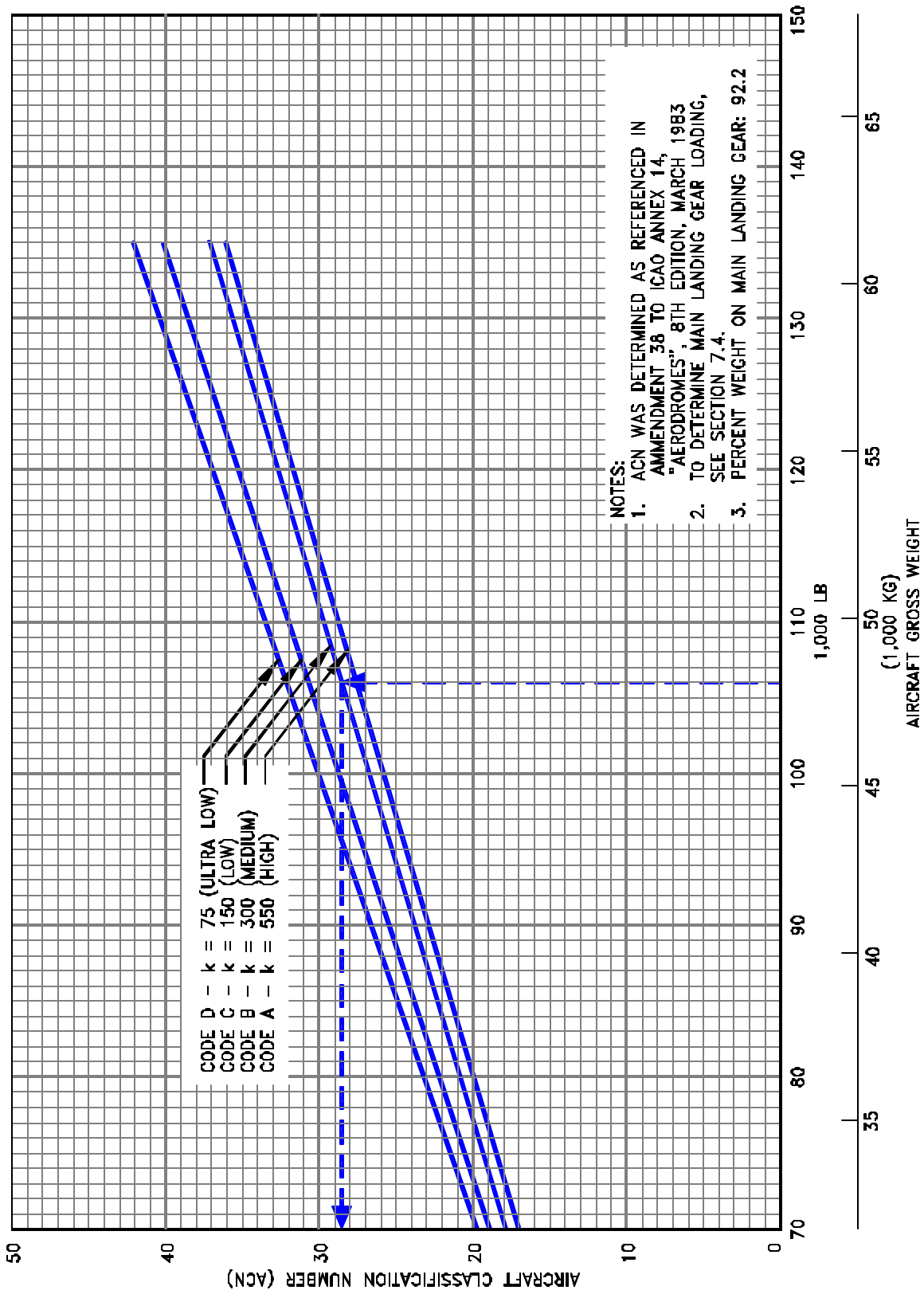

7.10.28 AIRCRAFT CLASSIFICATION NUMBER - RIGID PAVEMENT
 MODEL 737-500

NOTES:
* TIRES -- H42 x 16-19 24PR

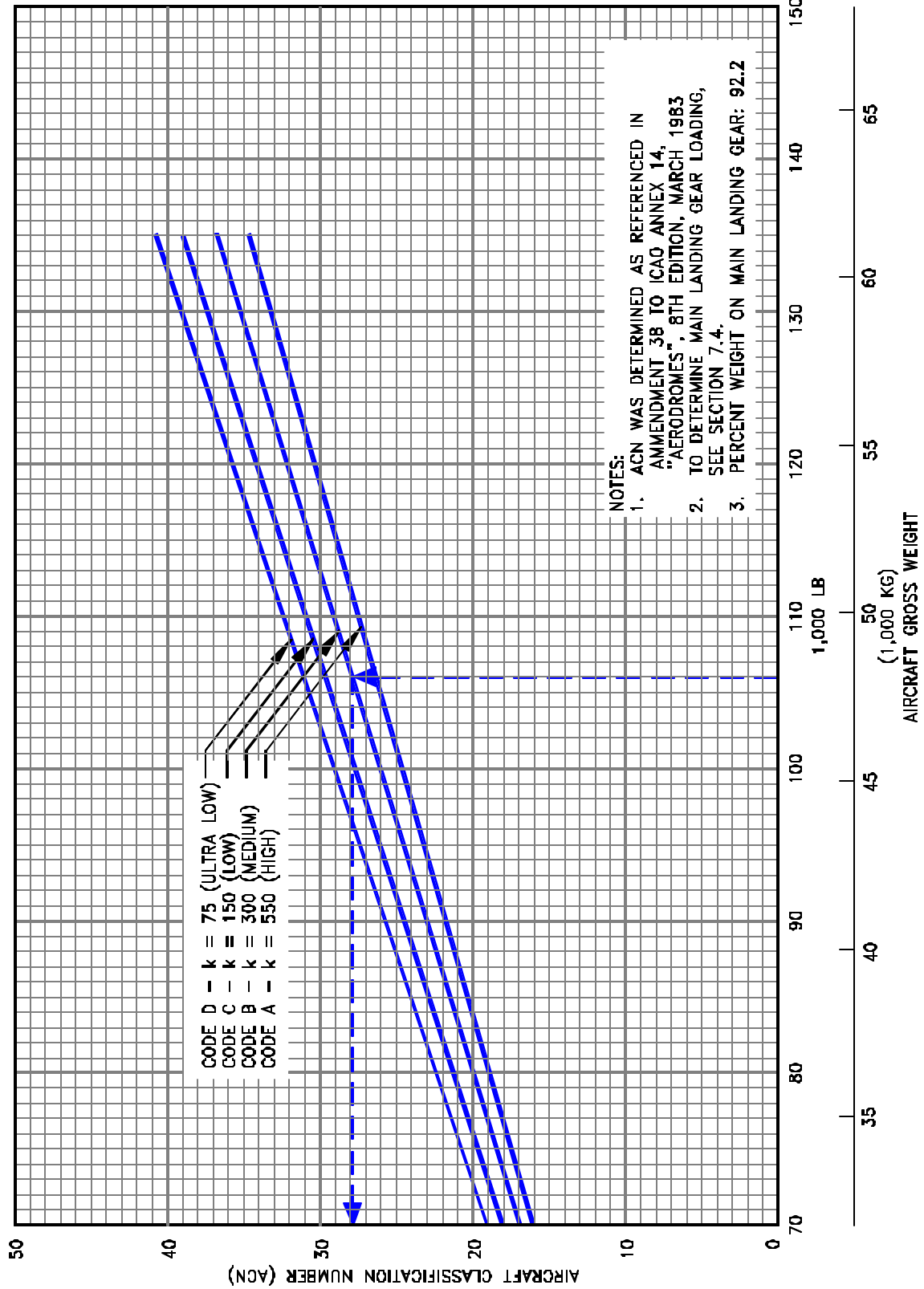

NOTES:
1. ACN WAS DETERMINED AS REFERENCED IN AMMENDMENT 3B TO ICAO ANNEX 14, "AERODROMES", 8TH EDITION, MARCH, 1983
2. TO DETERMINE MAIN LANDING GEAR LOADING, SEE SECTION 7.4.
3. PERCENT WEIGHT ON MAIN LANDING GEAR: 92.2

7.10.29 AIRCRAFT CLASSIFICATION NUMBER - RIGID PAVEMENT
MODEL 737-500 (LOW PRESSURE TIRES)

NOTES:
 * TIRES - H43.5 x 16.0 - 21, 24PR OR 28PR
 * PRESSURE - 182 PSI (12.80 KG/SQ CM)

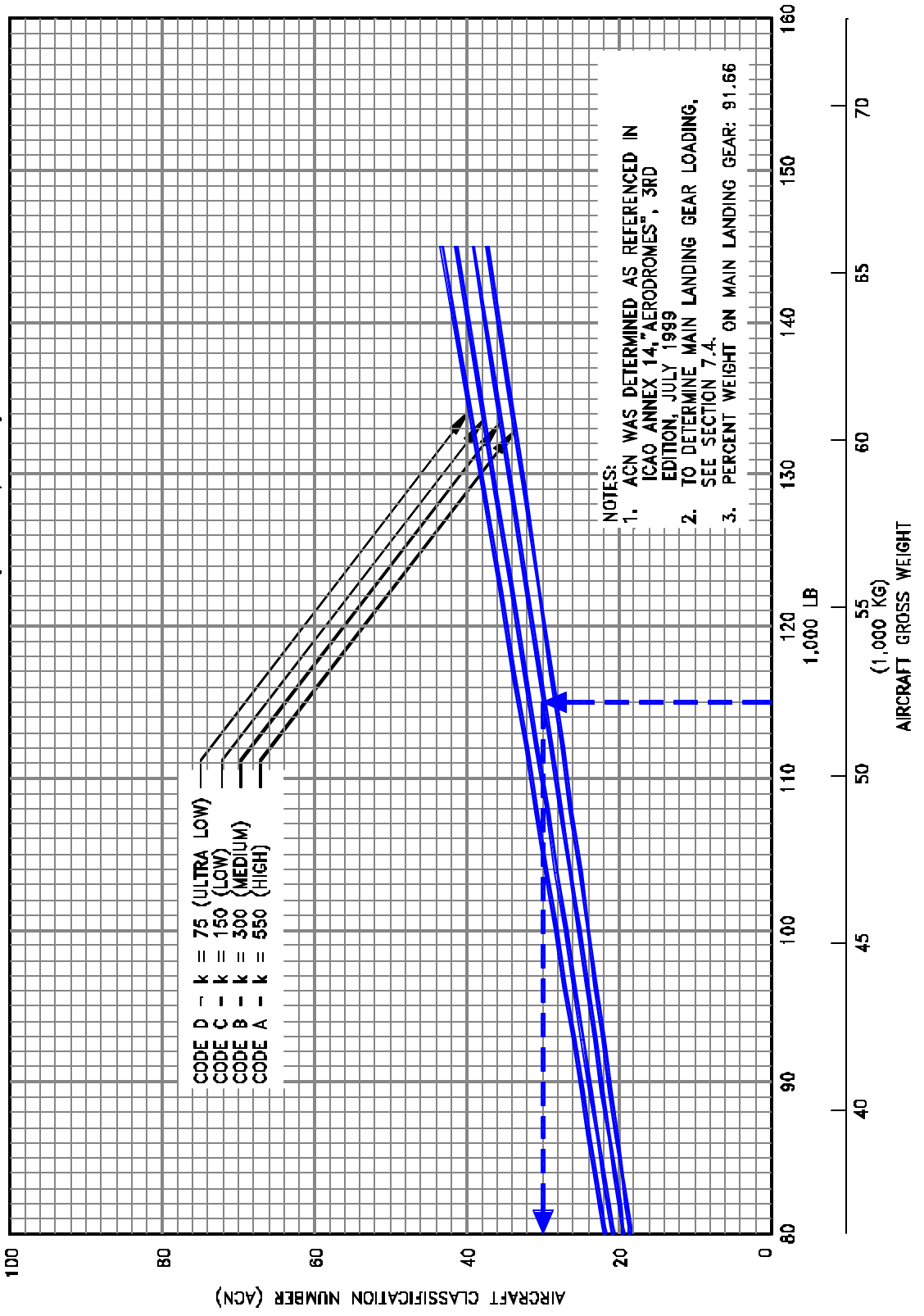

7.10.30 AIRCRAFT CLASSIFICATION NUMBER - RIGID PAVEMENT
 MODEL 737-600

NOTES:
 * TIRES - H44.5 x 16.5 - 21, 28PR
 * PRESSURE - 168 PSI (11.81 KG/SQ CM)

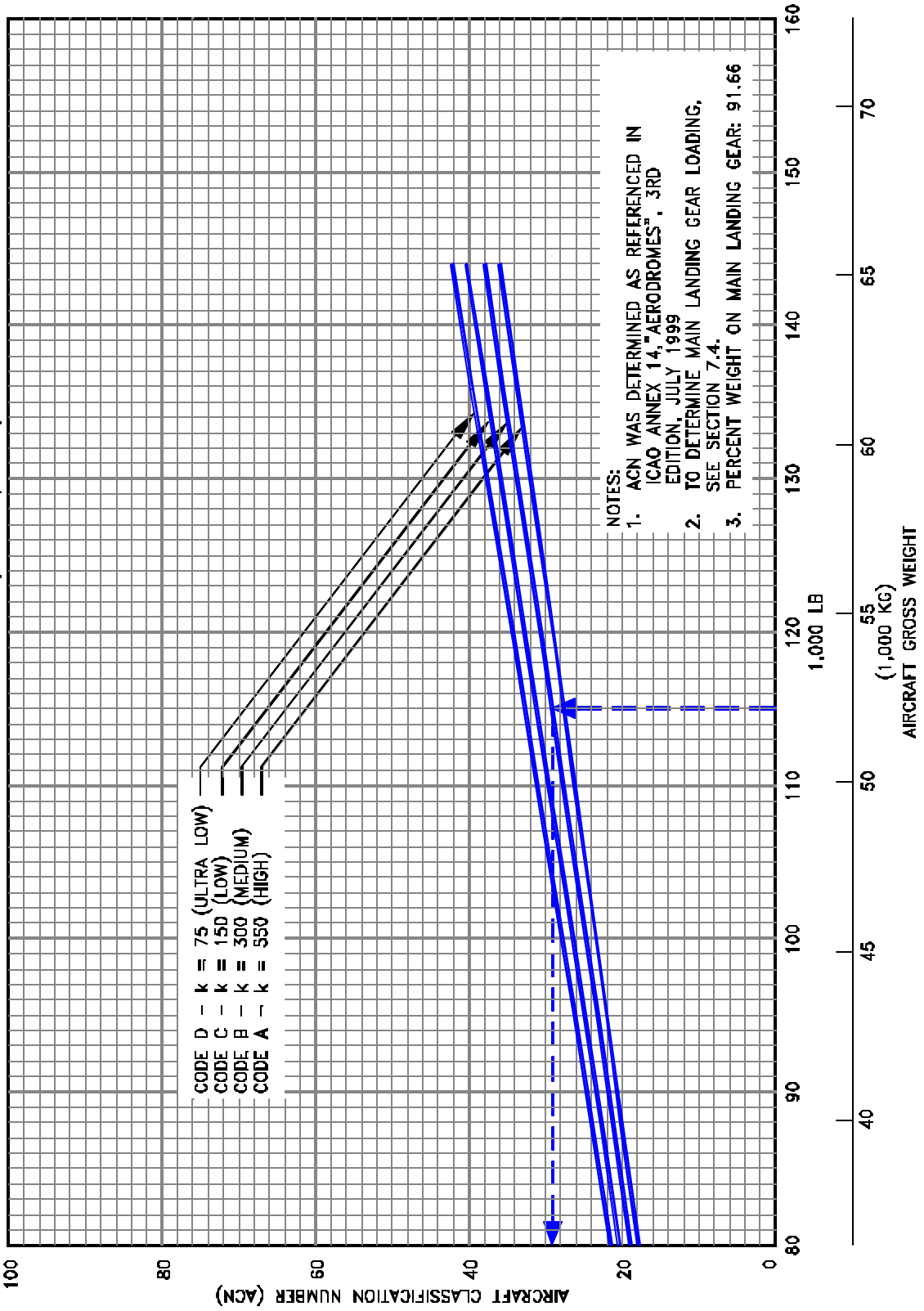

7.10.31 AIRCRAFT CLASSIFICATION NUMBER - RIGID PAVEMENT
 MODEL 737-600 (OPTIONAL TIRES)

NOTES:
 * TIRES - H43.5 x 16.0 - 21, 26PR
 * PRESSURE - 197 PSI (13.85 KG/SQ CM)

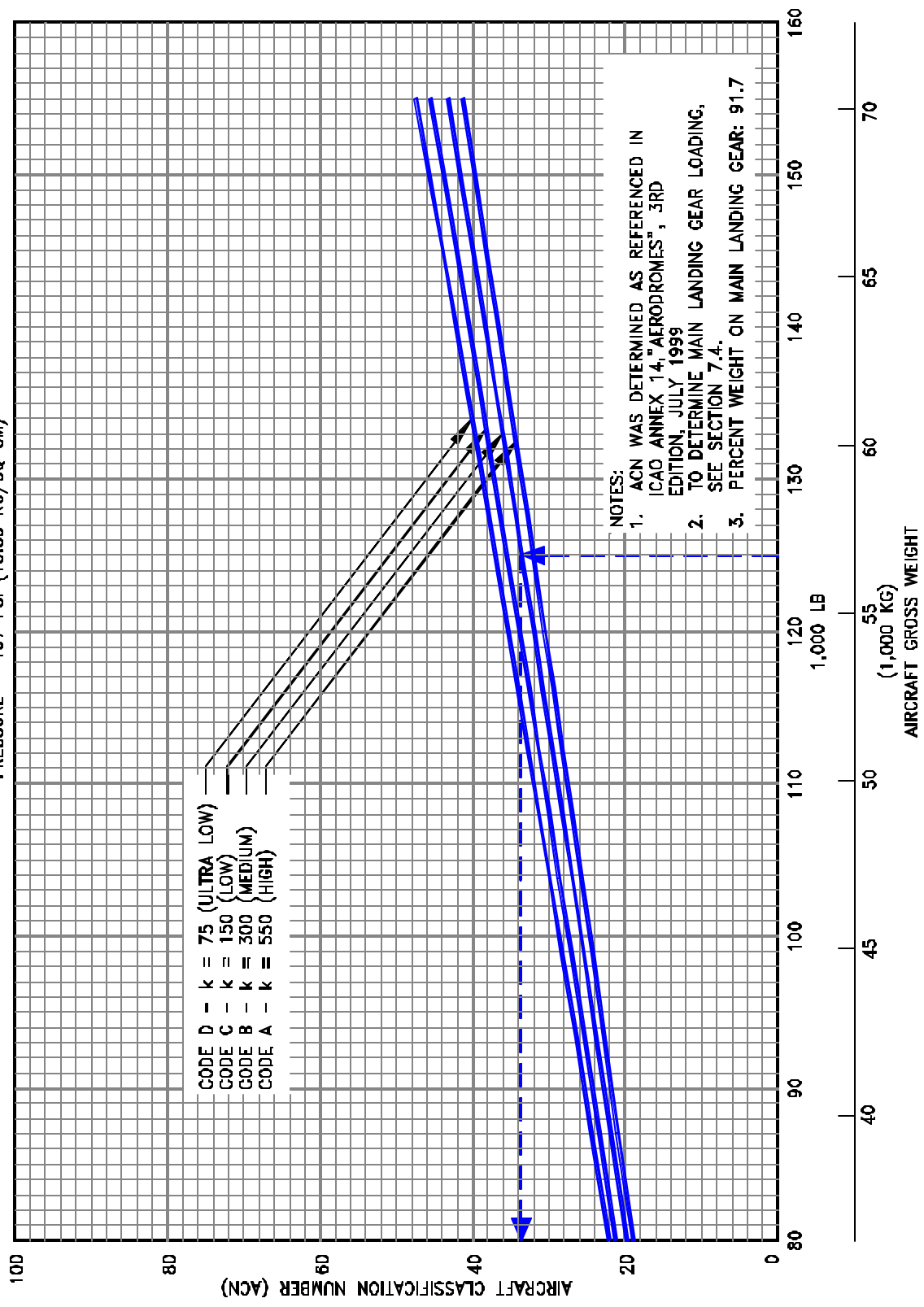

7.10.32 AIRCRAFT CLASSIFICATION NUMBER - RIGID PAVEMENT
 MODEL 737-700 WITH AND WITHOUT WINGLETS

NOTES:
 * TIRES - H44.5 x 16.5 - 21, 28PR
 * PRESSURE - 179 PSI (12.59 KG/SQ CM)

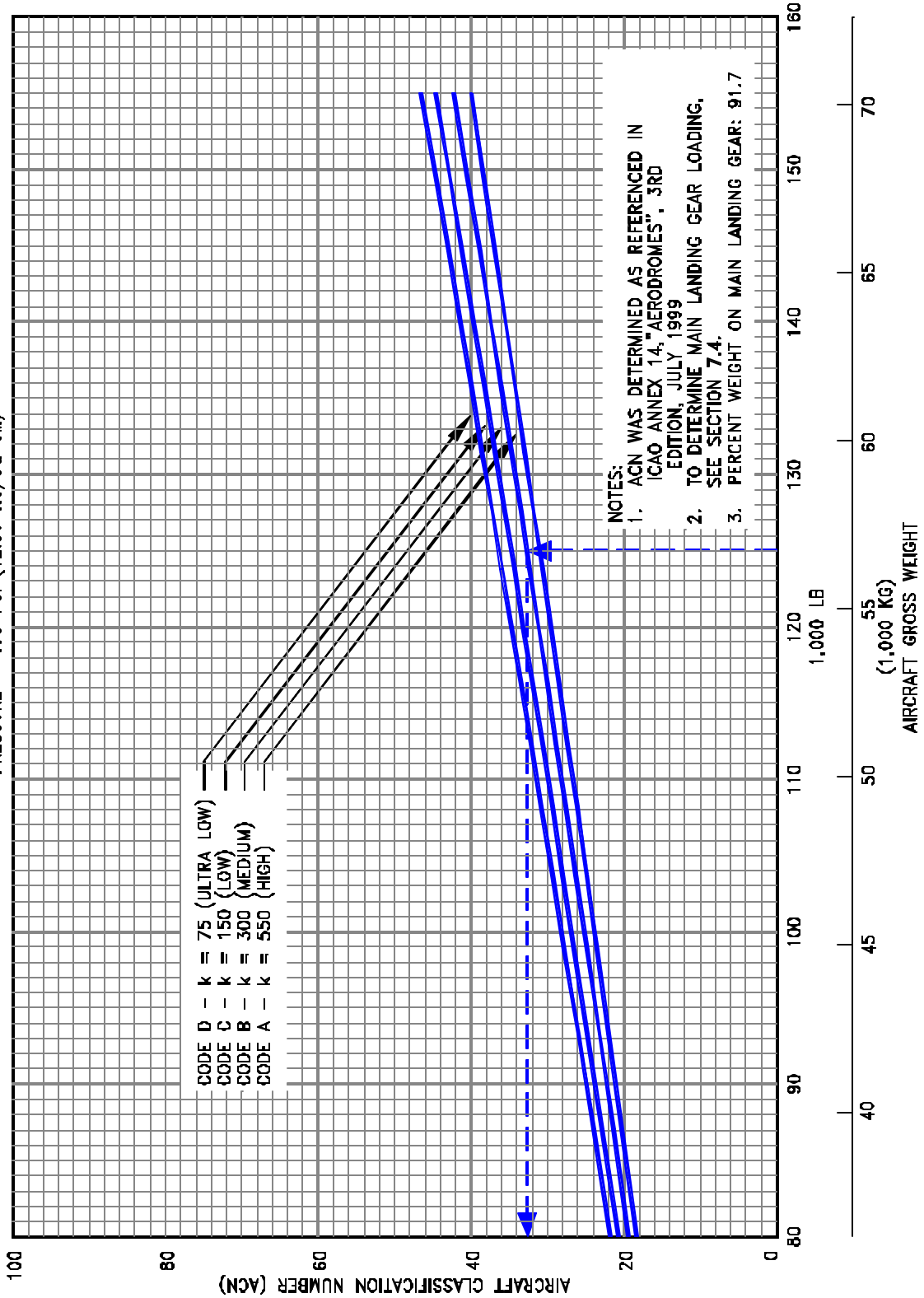

7.10.33 AIRCRAFT CLASSIFICATION NUMBER - RIGID PAVEMENT
 MODEL 737-700 (OPTIONAL TIRES) WITH AND WITHOUT WINGLETS

NOTES:
 * TIRES - H44.5 x 16.5 - 21, 28PR
 * PRESSURE - 204 PSI (14.34 KG/SQ CM)

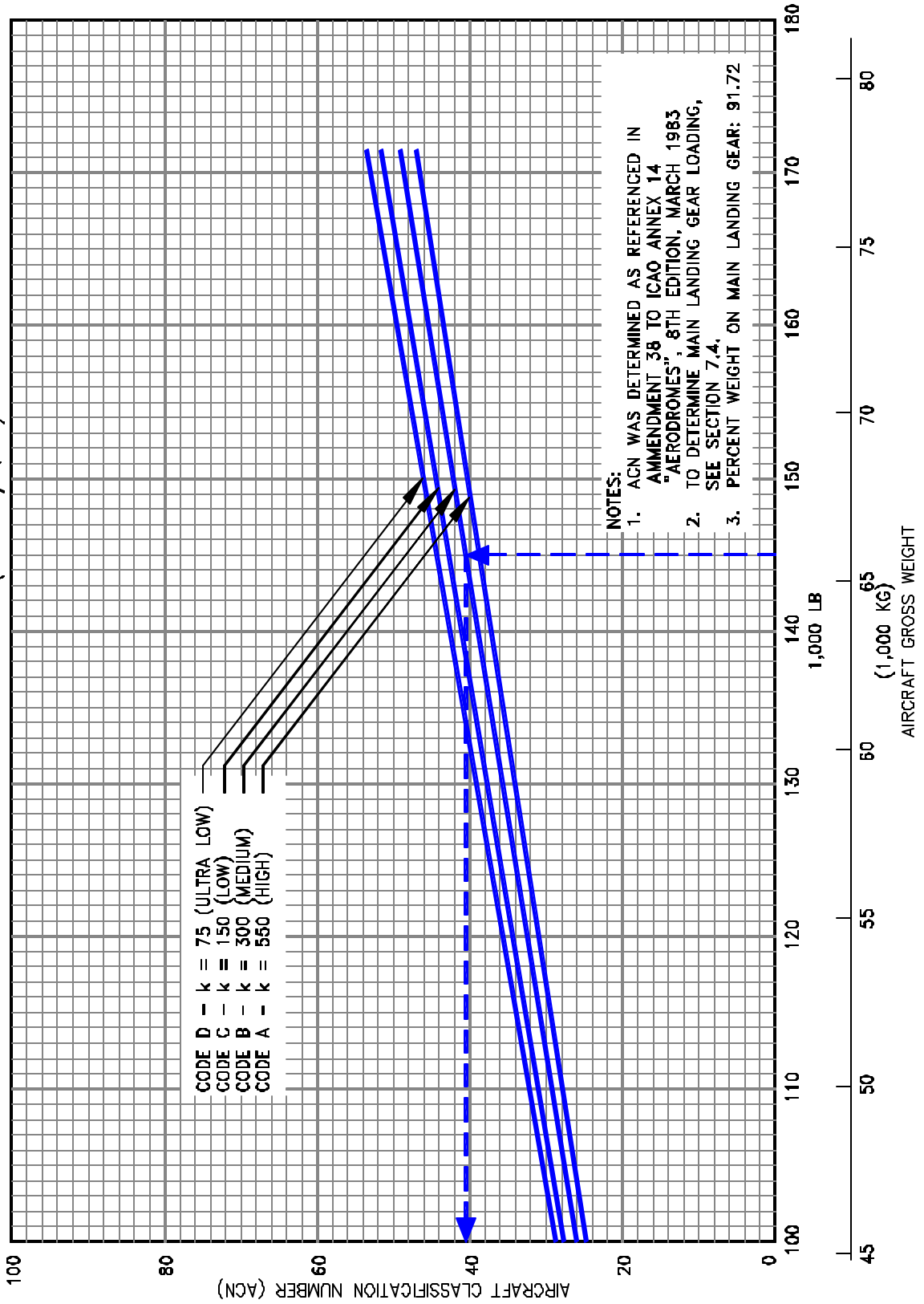

7.10.34 AIRCRAFT CLASSIFICATION NUMBER - RIGID PAVEMENT
 MODEL 737 BBJ

NOTES:
 * TIRES - H44.5 x 16.5 - 21, 28PR
 * PRESSURE - 204 PSI (14.34 KG/SQ CM)

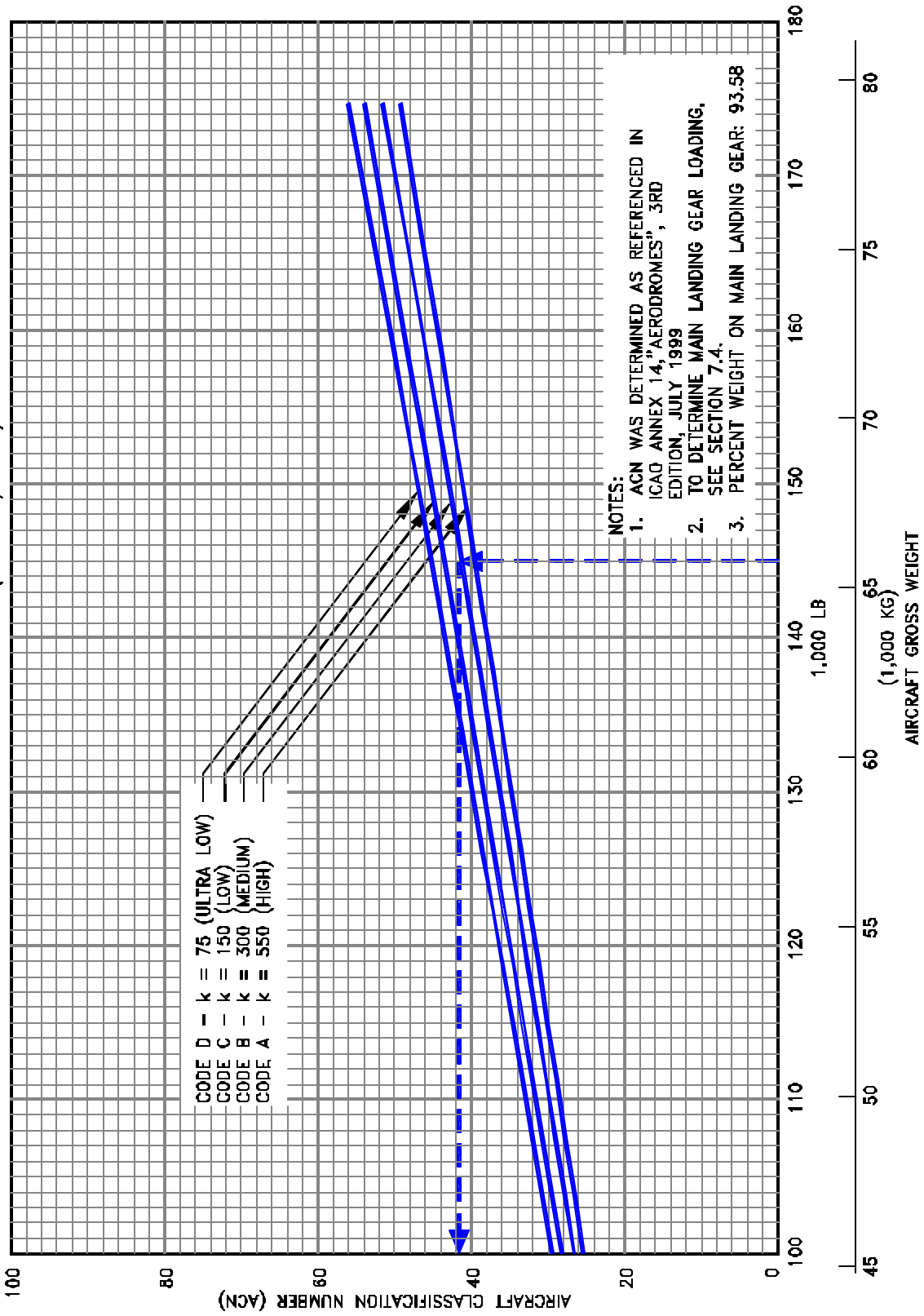

7.10.35 AIRCRAFT CLASSIFICATION NUMBER - RIGID PAVEMENT
 MODEL 737-800 WITH AND WITHOUT WINGLETS

D6-58325-6

NOTES:
 * TIRES - H44.5 x 16.5 - 21, 28PR
 * PRESSURE - 204 PSI (14.34 KG/SQ CM)

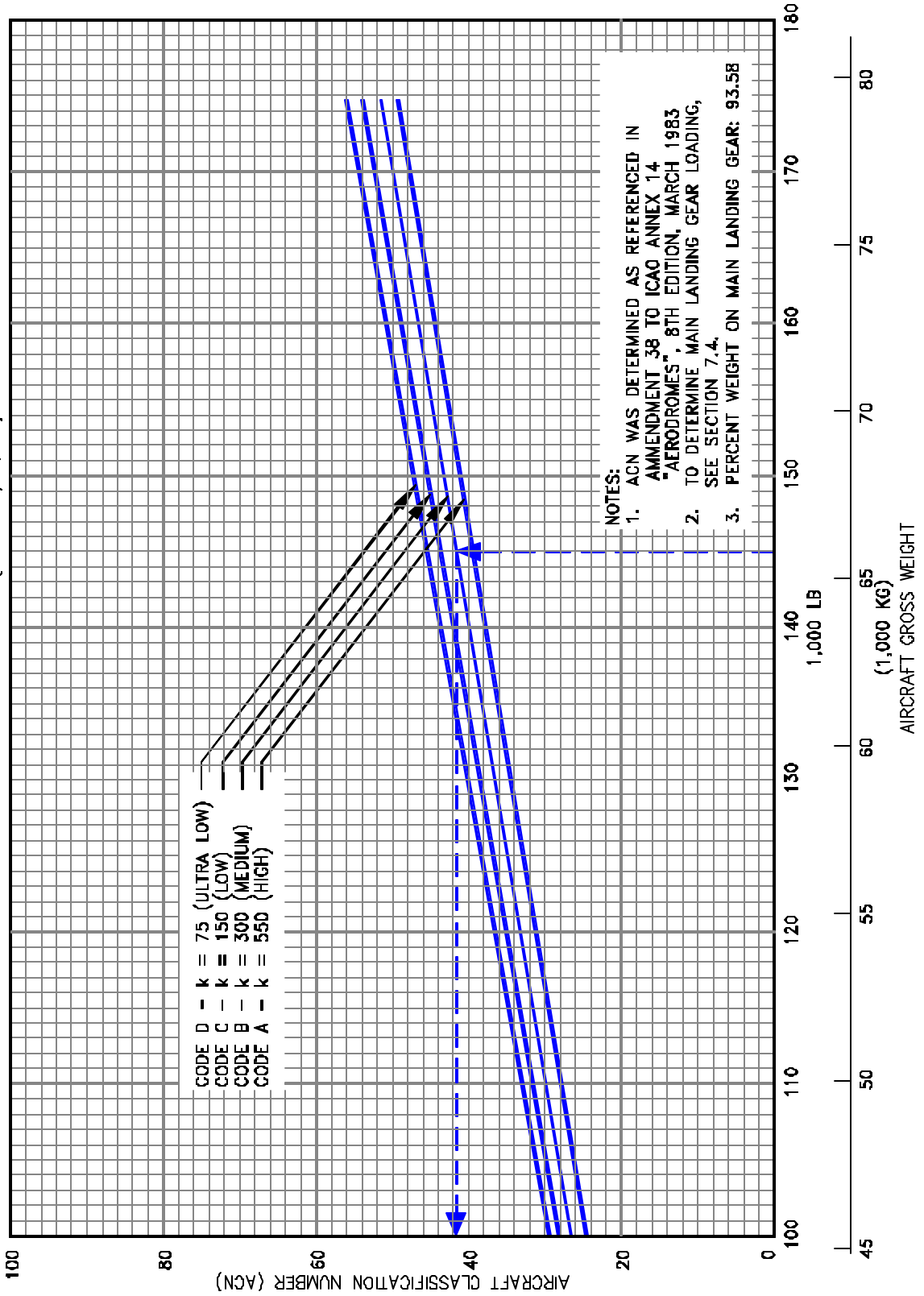

7.10.36 AIRCRAFT CLASSIFICATION NUMBER - RIGID PAVEMENT
 MODEL 737 BBJ2

NOTES:
 * TIRES - H44.5 X 16.5 - 21, 28PR
 * PRESSURE - 204 PSI (14.34 KG/SQ CM)

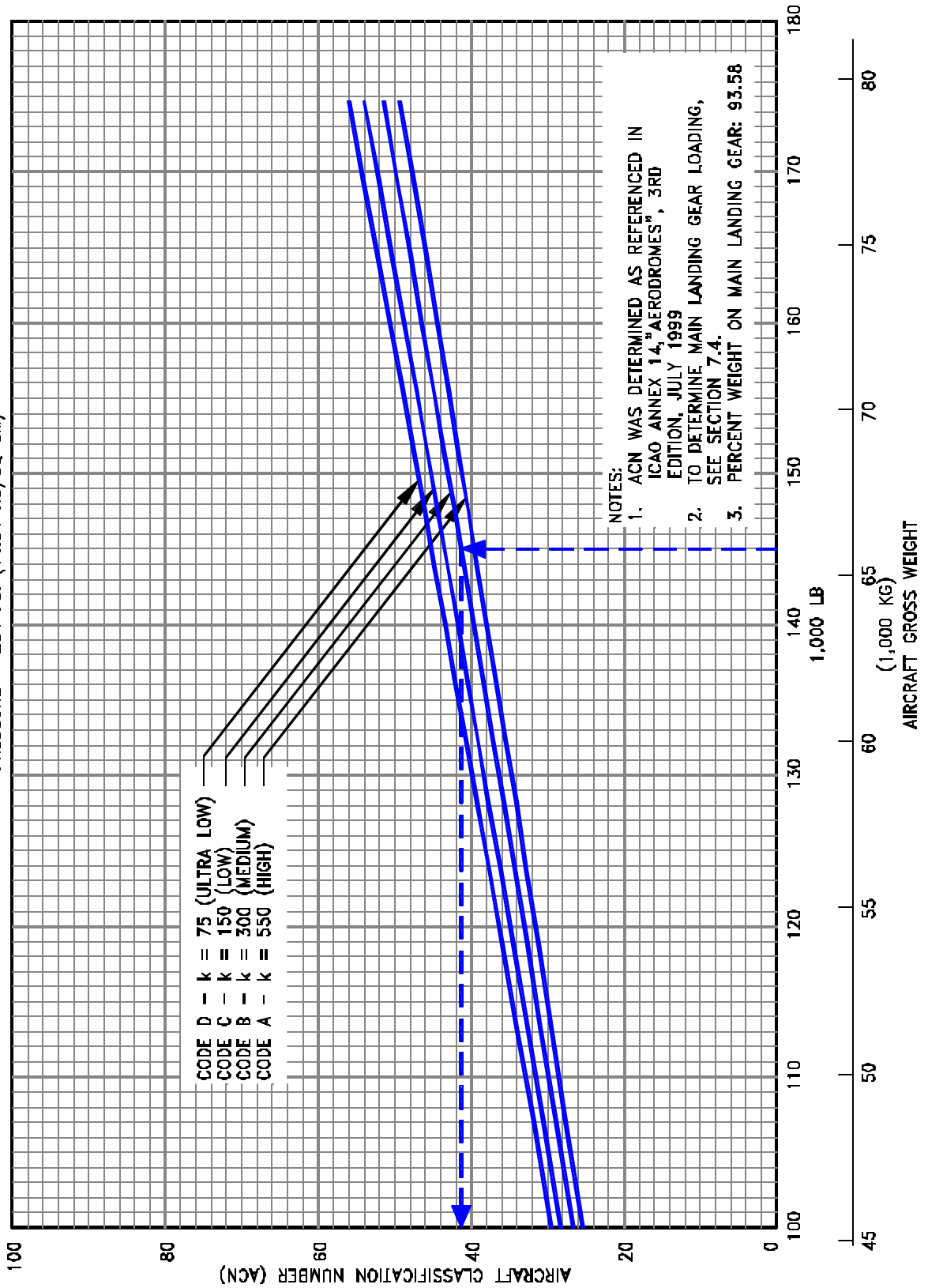

7.10.37 AIRCRAFT CLASSIFICATION NUMBER - RIGID PAVEMENT
 MODEL 737-900 WITH AND WITHOUT WINGLETS

D6-58325-6

PRELIMINARY INFORMATION

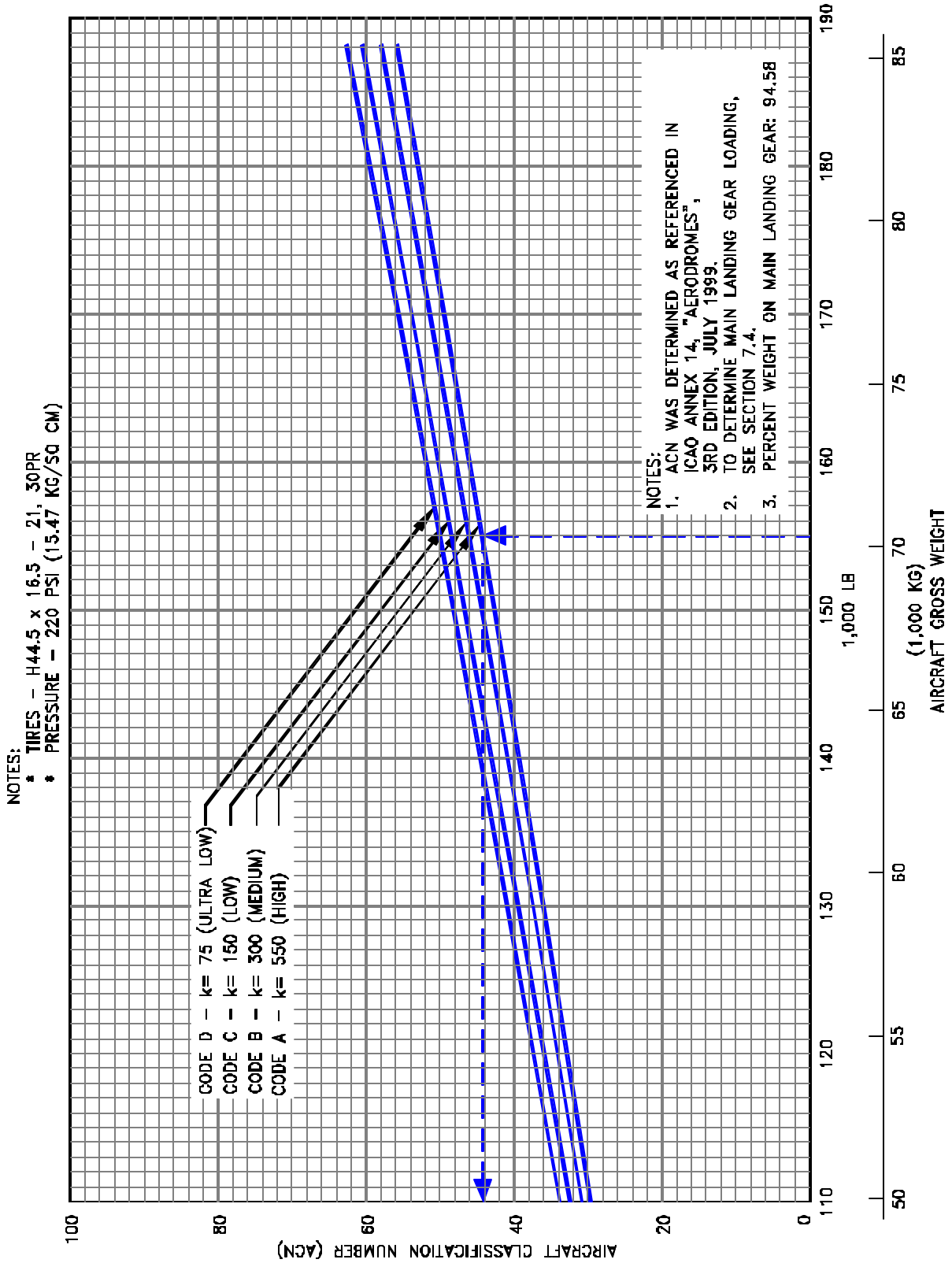

7.10.38 AIRCRAFT CLASSIFICATION NUMBER - RIGID PAVEMENT
 MODEL 737-900ER WITH AND WITHOUT WINGLETS

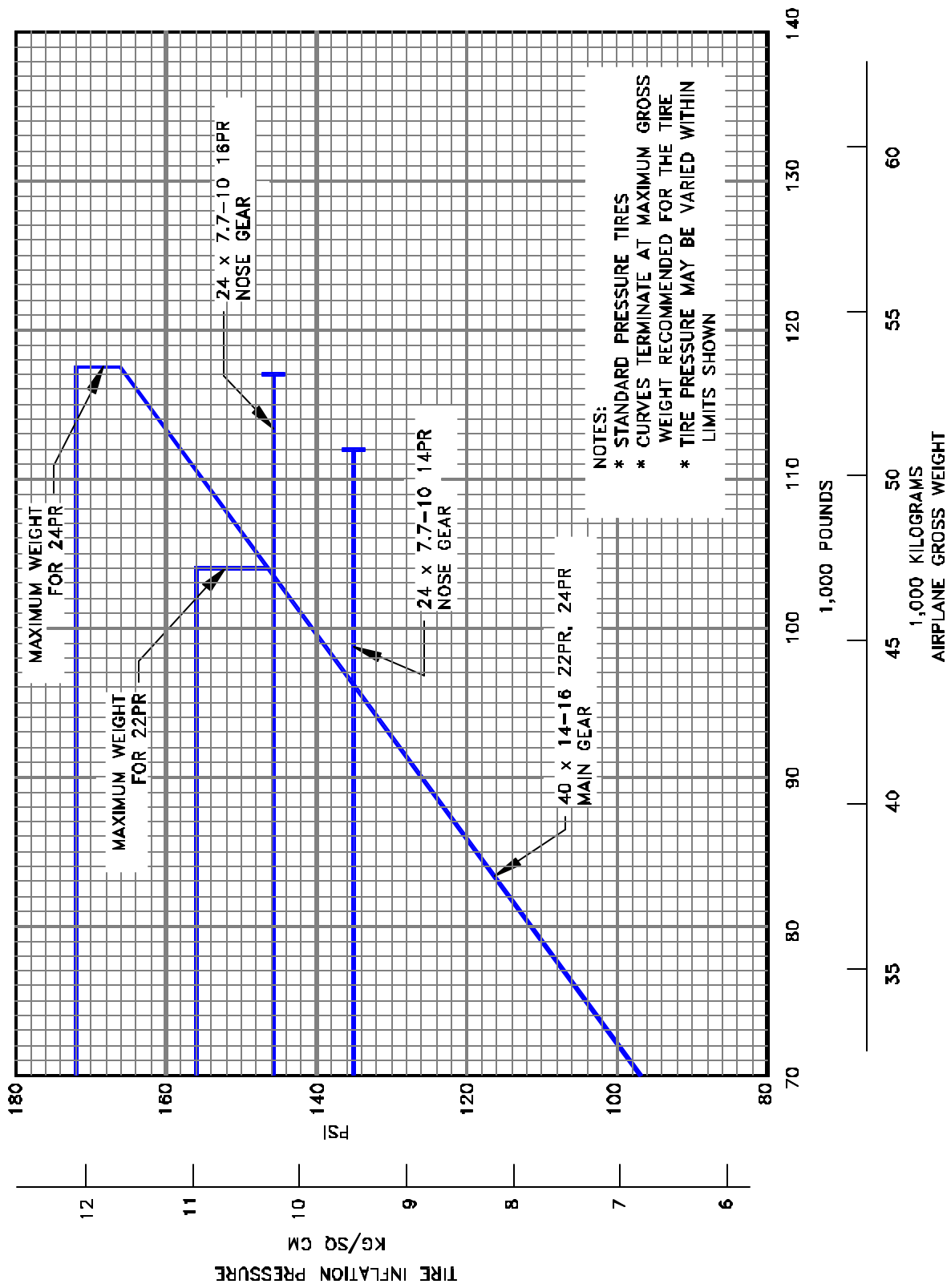

7.11.1 TIRE INFLATION CHART
 MODEL 737-100

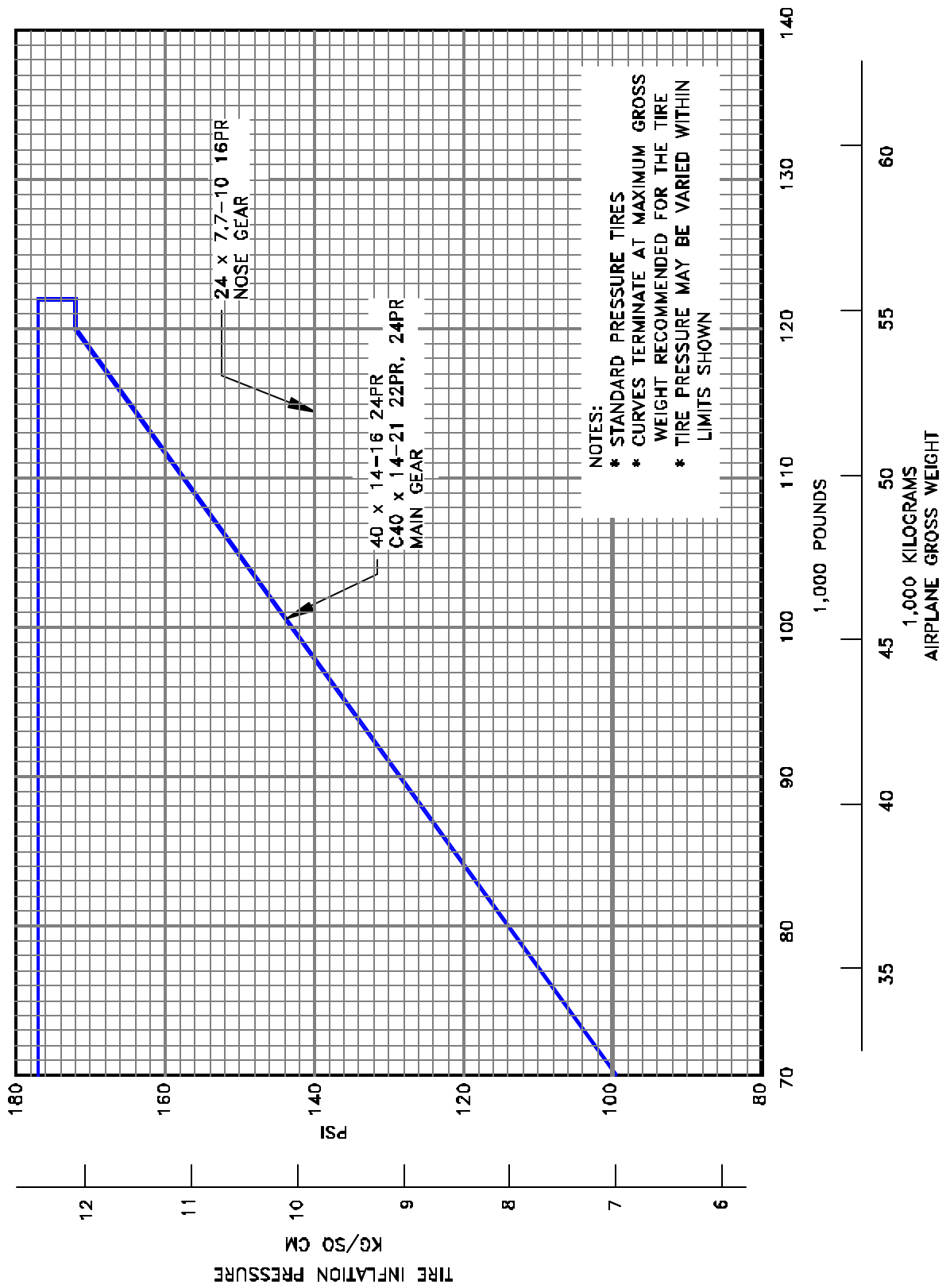

7.11.2 TIRE INFLATION CHART
 MODEL 737-100, -200

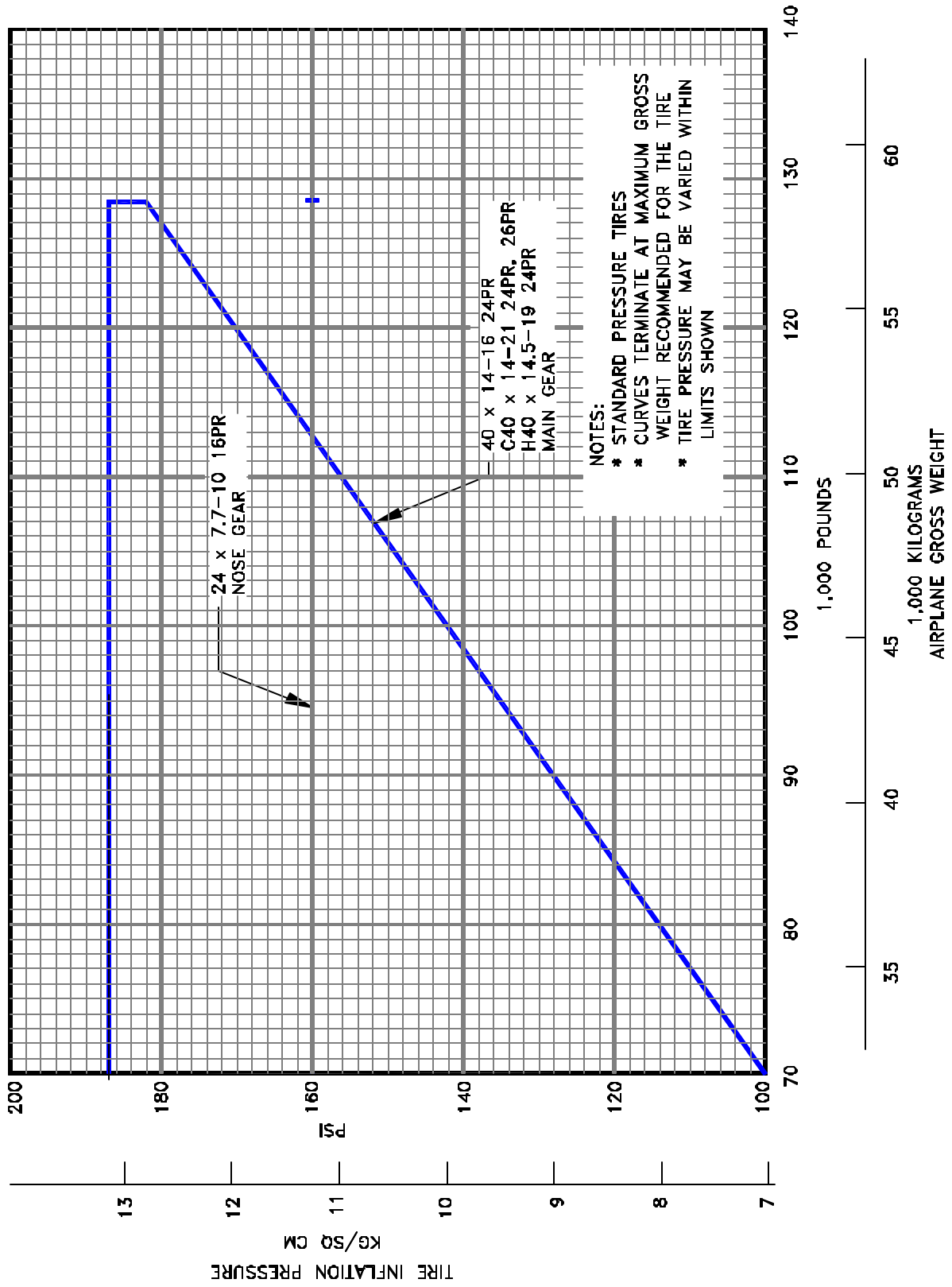

7.11.3 TIRE INFLATION CHART
 MODEL ADV 737--200

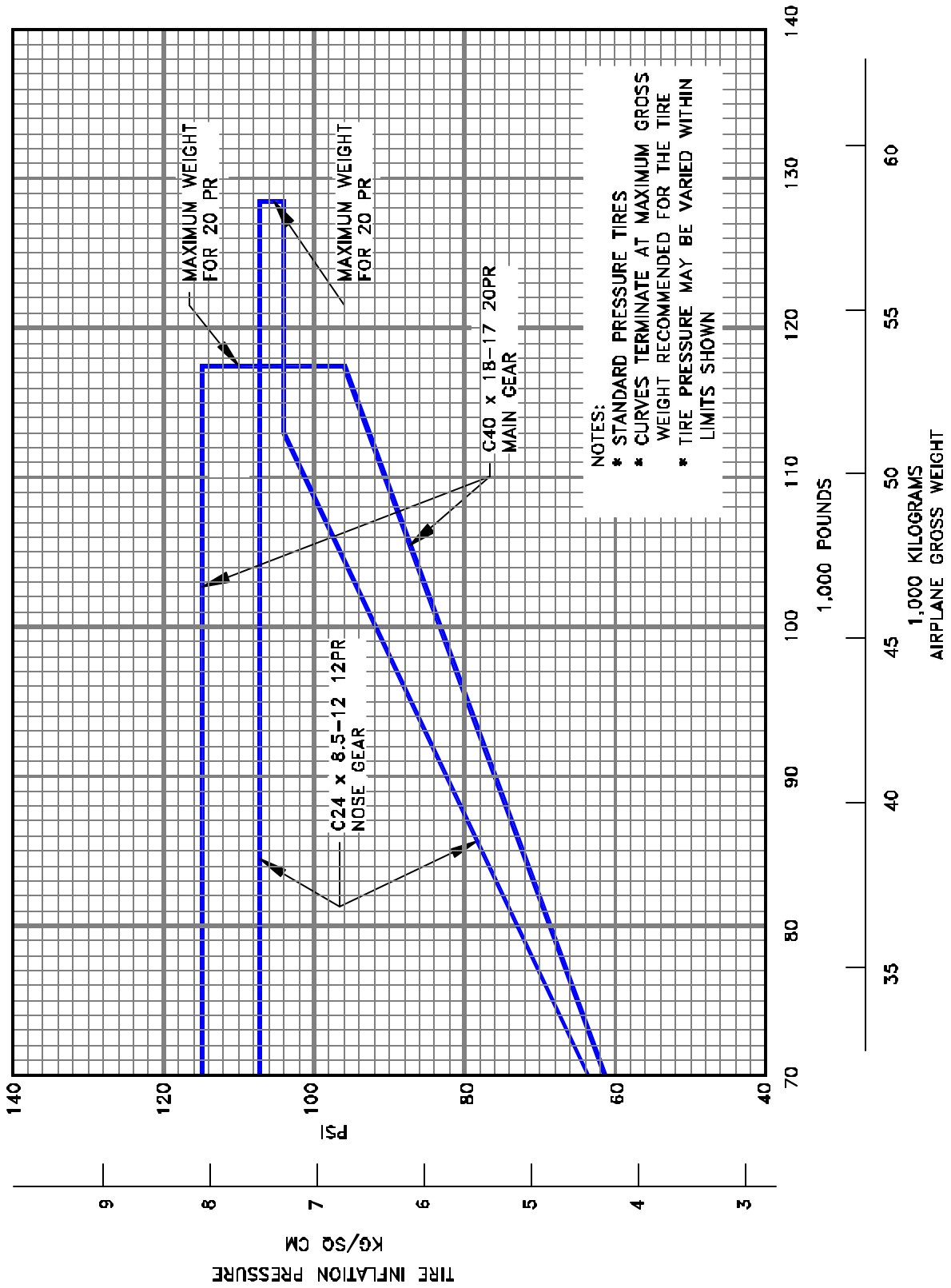

7.11.4 TIRE INFLATION CHART
 MODEL 737-200 (LOW PRESSURE TIRES)

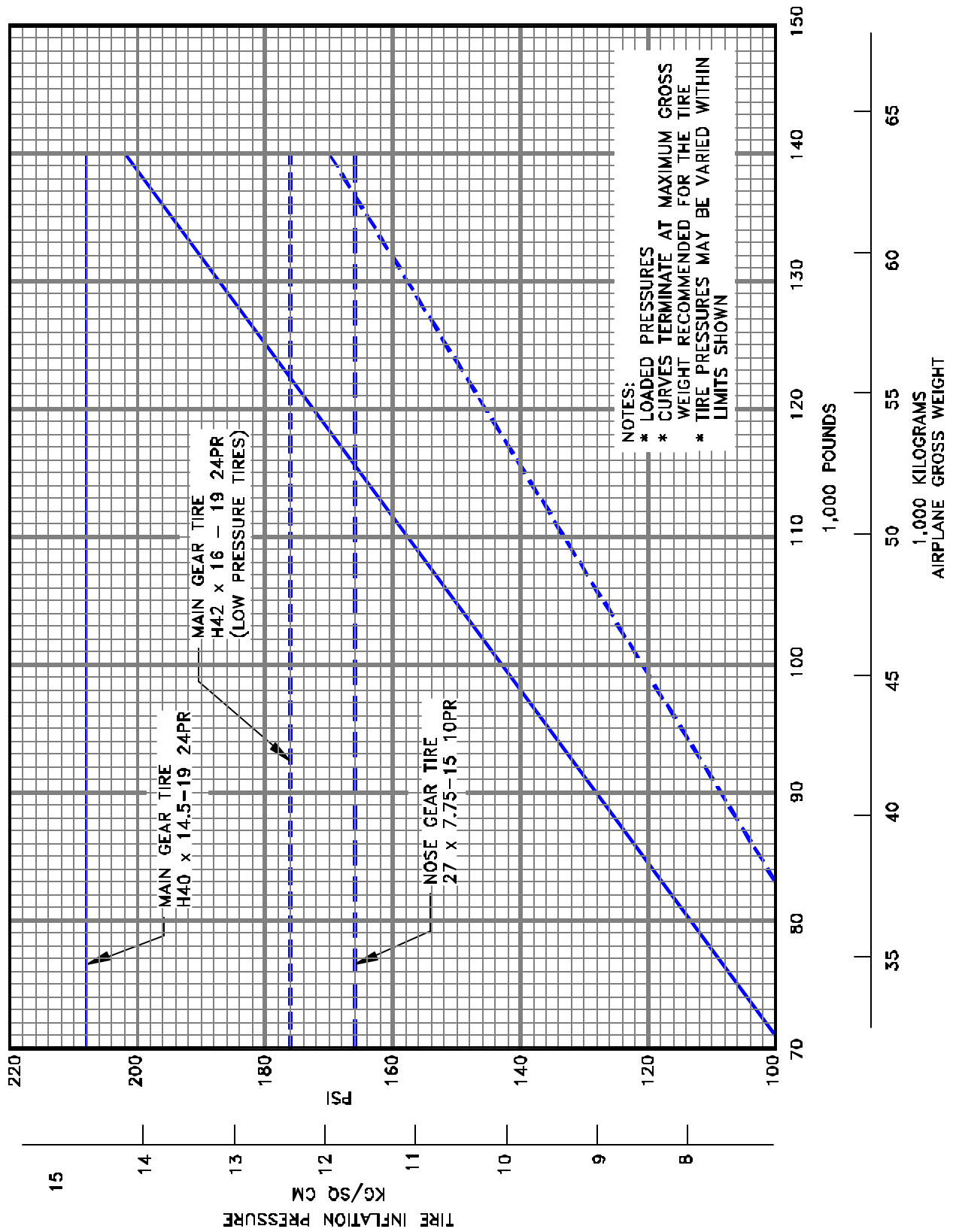

7.11.5 TIRE INFLATION CHART
 MODEL 737-300

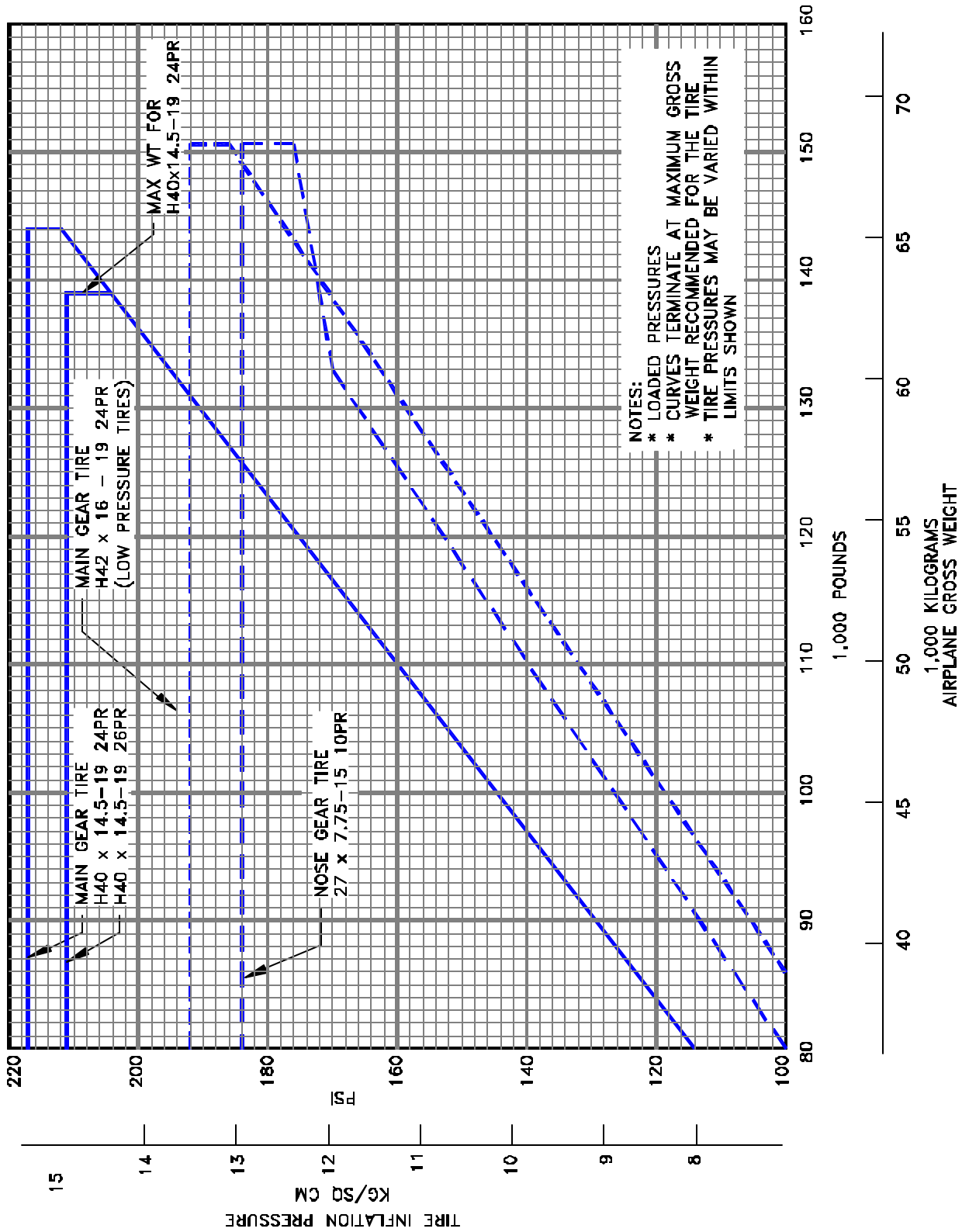

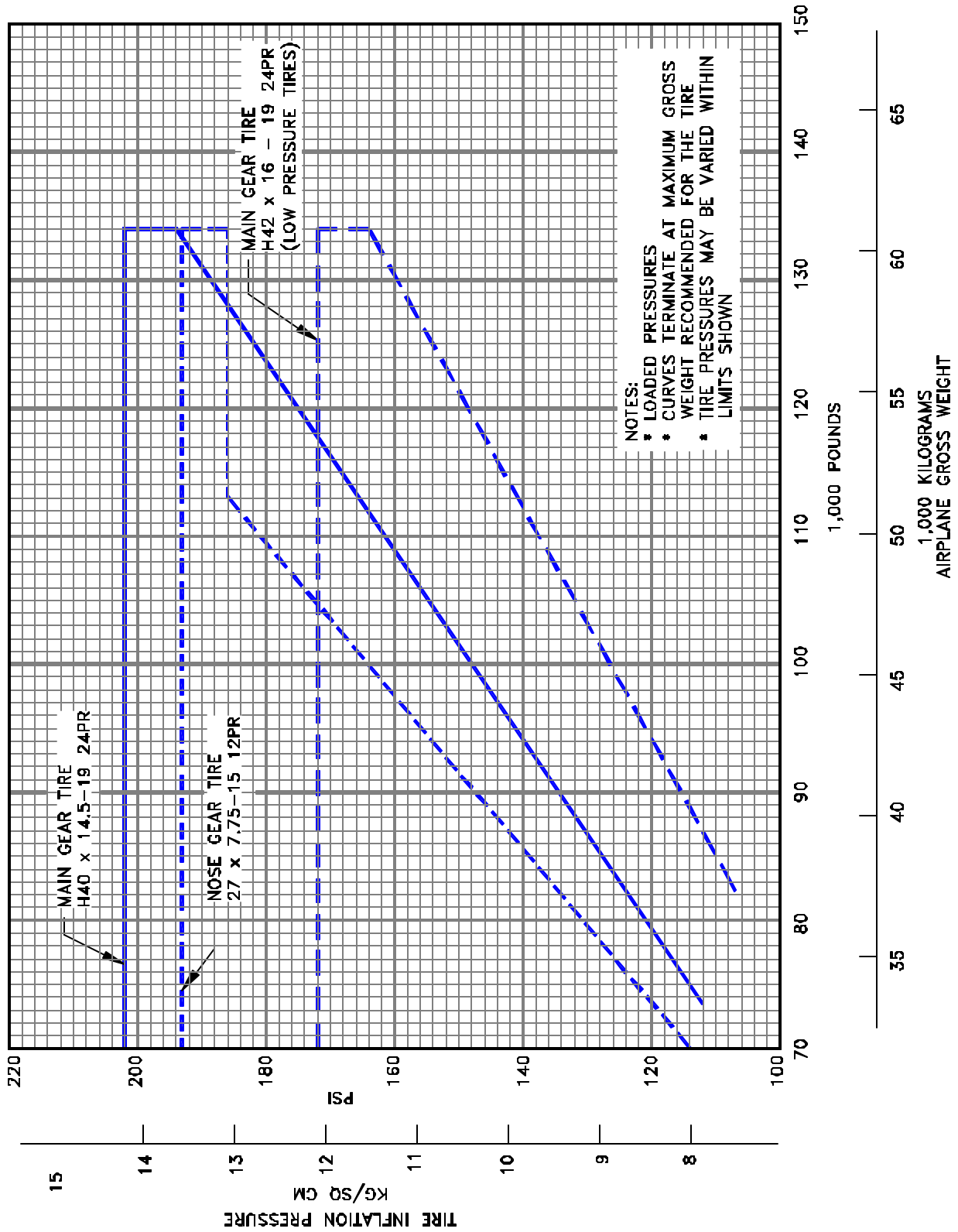

7.11.7 TIRE INFLATION CHART
MODEL 737-500

8.0 FUTURE 737 DERIVATIVE AIRPLANES

8.0 FUTURE 737 DERIVATIVE AIRPLANES

Development of these derivatives will depend on airline requirements. The impact of airline requirements on airport facilities will be a consideration in the configuration and design of these derivatives.

9.0 SCALED 737 DRAWINGS

- 9.1 - 9.5 Scaled Drawings, 737-100**
- 9.6 - 9.10 Scaled Drawings, 737-200**
- 9.11 – 9.15 Scaled Drawings, 737-300**
- 9.16 – 9.20 Scaled Drawings, 737-300 With Winglets**
- 9.21 – 9.25 Scaled Drawings, 737-400**
- 9.26 – 9.30 Scaled Drawings, 737-500**
- 9.31 - 9.35 Scaled Drawings, 737-600**
- 9.36 - 9.40 Scaled Drawings, 737-600 With Winglets**
- 9.41 – 9.45 Scaled Drawings, 737-700**
- 9.46 - 9.50 Scaled Drawings, 737-700 With Winglets, 737 BBJ**
- 9.51 - 9.55 Scaled Drawings, 737-800**
- 9.56 - 9.60 Scaled Drawings, 737-800 With Winglets, 737 BBJ2**
- 9.61 – 9.65 Scaled Drawings, 737-900, -900ER**
- 9.66 – 9.70 Scaled Drawings, 737-900, -900ER With Winglets**

9.0 SCALED DRAWINGS

The drawings in the following pages show airplane plan view drawings, drawn to approximate scale as noted. The drawings may not come out to exact scale when printed or copied from this document. Printing scale should be adjusted when attempting to reproduce these drawings. Three-view drawing files of the 737 airplane models, along with other Boeing airplane models, can be downloaded from the following website:

<http://www.boeing.com/airports>

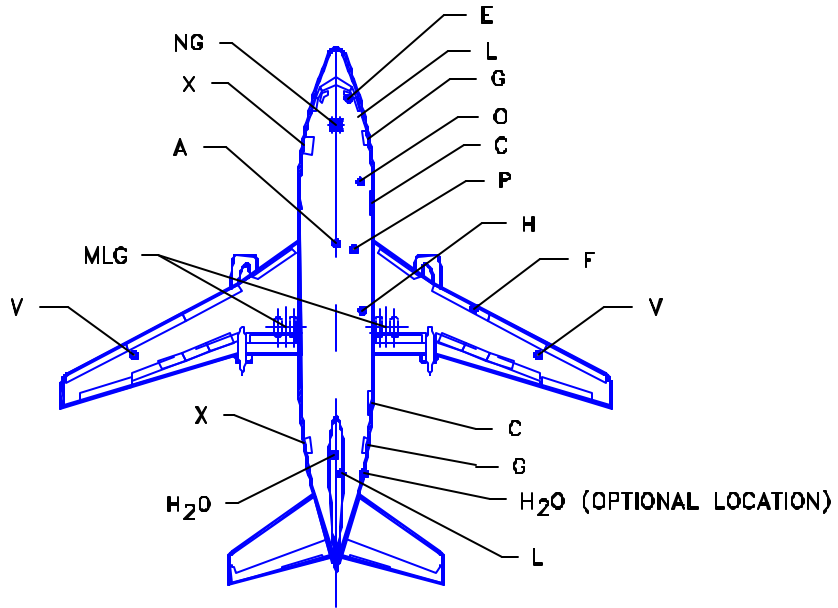
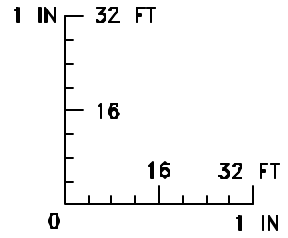

LEGEND

- A AIR CONDITIONING
- C CARGO DOOR
- E ELECTRICAL
- F FUEL
- G SERVICE DOOR
- H₂O POTABLE WATER
- L LAVATORY SERVICE
- MLG MAIN LANDING GEAR
- NG NOSE LANDING GEAR
- O OXYGEN
- P PNEUMATIC (AIR START)
- V FUEL VENT
- X PASSENGER DOOR

NOTE: FOR TURNING RADIUS DATA
SEE SECTIONS 4.2 AND 4.3

NOTE: WHEN PRINTING THIS DRAWING, MAKE SURE TO ADJUST FOR PROPER SCALING

9.1.1 SCALED DRAWING - 1 IN = 32 FT
MODEL 737-100

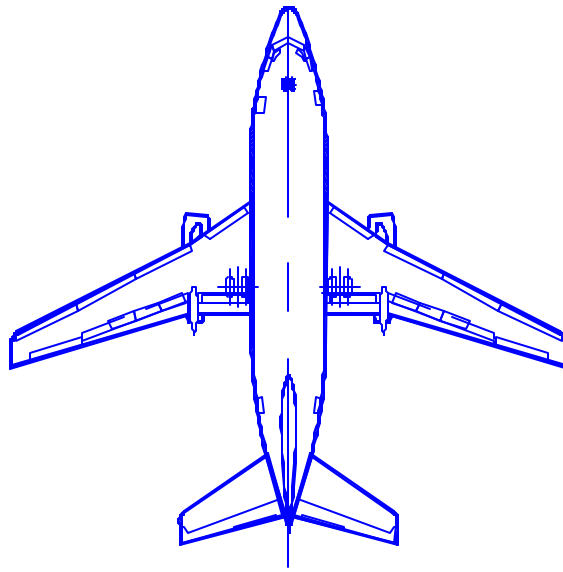
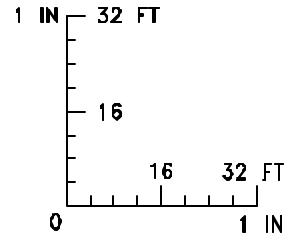

NOTE: WHEN PRINTING THIS DRAWING, MAKE SURE TO ADJUST FOR PROPER SCALING

9.1.2 SCALED DRAWING - 1 IN = 32 FT

MODEL 737-100

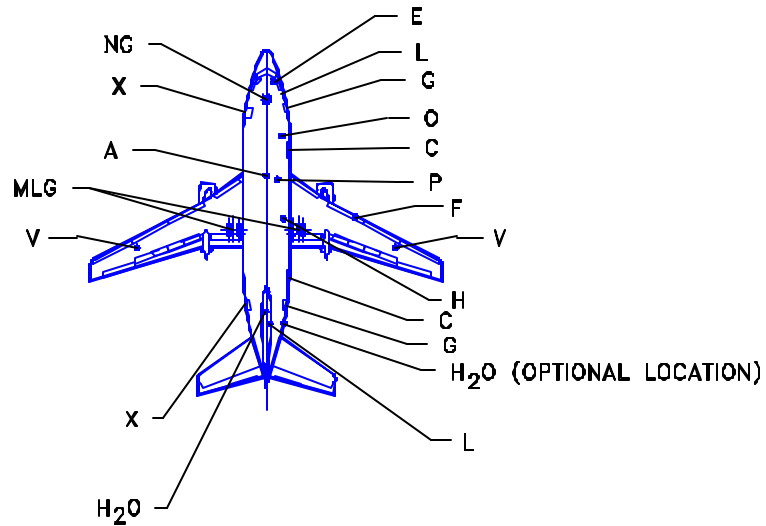
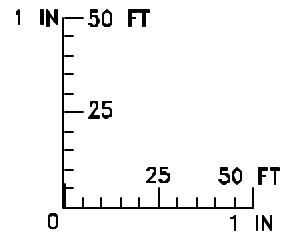

LEGEND

- A AIR CONDITIONING
- C CARGO DOOR
- E ELECTRICAL
- F FUEL
- G SERVICE DOOR
- H₂O POTABLE WATER
- L LAVATORY SERVICE
- MLG MAIN LANDING GEAR
- NG NOSE LANDING GEAR
- O OXYGEN
- P PNEUMATIC (AIR START)
- V FUEL VENT
- X PASSENGER DOOR

NOTE: FOR TURNING RADIUS DATA
SEE SECTIONS 4.2 AND 4.3

NOTE: WHEN PRINTING THIS DRAWING, MAKE SURE TO ADJUST FOR PROPER SCALING

9.2.1 SCALED DRAWING - 1 IN = 50 FT
MODEL 737-100

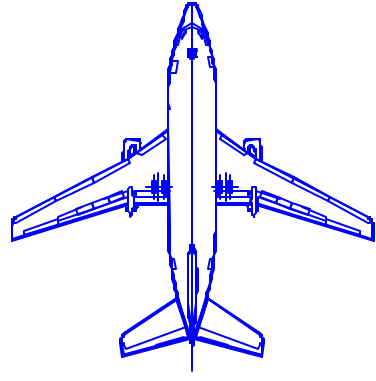
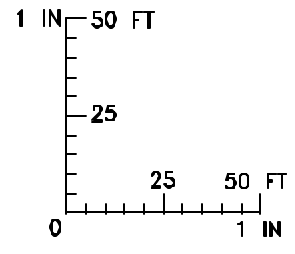

NOTE: WHEN PRINTING THIS DRAWING, MAKE SURE TO ADJUST FOR PROPER SCALING

9.2.2 SCALED DRAWING - 1 IN = 50 FT

MODEL 737-100

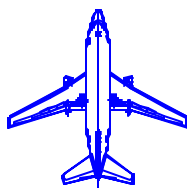
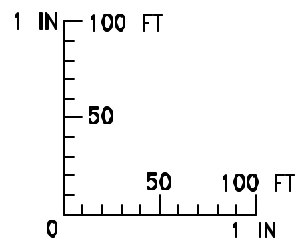

NOTE:

SEE CORRESPONDING PAGE FOR 1 IN = 32 FT
FOR IDENTIFICATIONS OF SERVICE POINTS

LEGEND

- A AIR CONDITIONING
- C CARGO DOOR
- E ELECTRICAL
- F FUEL
- G SERVICE DOOR
- H₂O POTABLE WATER
- L LAVATORY SERVICE
- MLG MAIN LANDING GEAR
- NG NOSE LANDING GEAR
- D OXYGEN
- P PNEUMATIC (AIR START)
- V FUEL VENT
- X PASSENGER DOOR

NOTE: FOR TURNING RADIUS DATA
SEE SECTIONS 4.2 AND 4.3

NOTE: WHEN PRINTING THIS DRAWING, MAKE SURE TO ADJUST FOR PROPER SCALING

9.3.1 SCALED DRAWING - 1 IN = 100 FT
MODEL 737-100

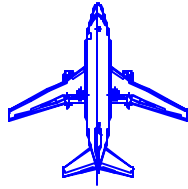
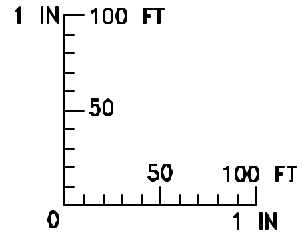

NOTE: WHEN PRINTING THIS DRAWING, MAKE SURE TO ADJUST FOR PROPER SCALING

9.3.2 SCALED DRAWING - 1 IN = 100 FT
MODEL 737-100

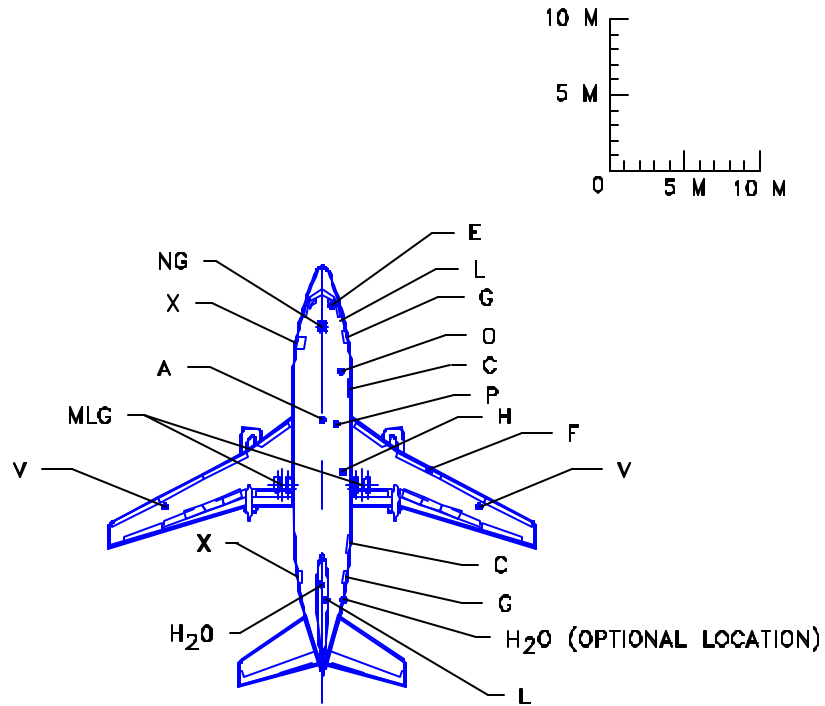

LEGEND

- A AIR CONDITIONING
- C CARGO DOOR
- E ELECTRICAL
- F FUEL
- G SERVICE DOOR
- H₂O POTABLE WATER
- L LAVATORY SERVICE
- MLG MAIN LANDING GEAR
- NG NOSE LANDING GEAR
- O OXYGEN
- P PNEUMATIC (AIR START)
- V FUEL VENT
- X PASSENGER DOOR

NOTE: FOR TURNING RADIUS DATA
SEE SECTIONS 4.2 AND 4.3

NOTE: WHEN PRINTING THIS DRAWING, MAKE SURE TO ADJUST FOR PROPER SCALING

9.4.1 SCALED DRAWING – 1:500
MODEL 737-100

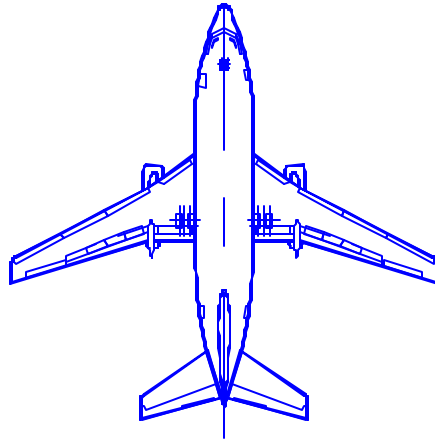
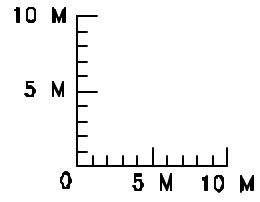

NOTE: WHEN PRINTING THIS DRAWING, MAKE SURE TO ADJUST FOR PROPER SCALING

9.4.2 SCALED DRAWING – 1:500

MODEL 737-100

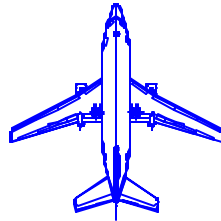
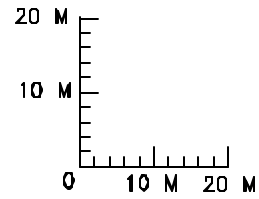

NOTE:

SEE CORRESPONDING PAGE FOR 1 IN = 32 FT
FOR IDENTIFICATIONS OF SERVICE POINTS

LEGEND

A	AIR CONDITIONING
C	CARGO DOOR
E	ELECTRICAL
F	FUEL
G	SERVICE DOOR
H ₂ O	POTABLE WATER
L	LAVATORY SERVICE
MLG	MAIN LANDING GEAR
NG	NOSE LANDING GEAR
O	OXYGEN
P	PNEUMATIC (AIR START)
V	FUEL VENT
X	PASSENGER DOOR

NOTE: FOR TURNING RADIUS DATA
SEE SECTIONS 4.2 AND 4.3

NOTE: WHEN PRINTING THIS DRAWING, MAKE SURE TO ADJUST FOR PROPER SCALING

9.5.1 SCALED DRAWING – 1:1000
MODEL 737-100

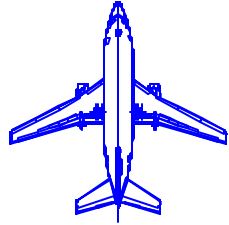
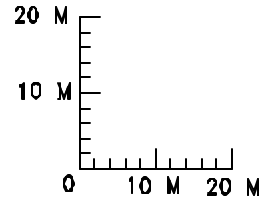

NOTE: WHEN PRINTING THIS DRAWING, MAKE SURE TO ADJUST FOR PROPER SCALING

9.5.2 SCALED DRAWING – 1:1000
MODEL 737-100

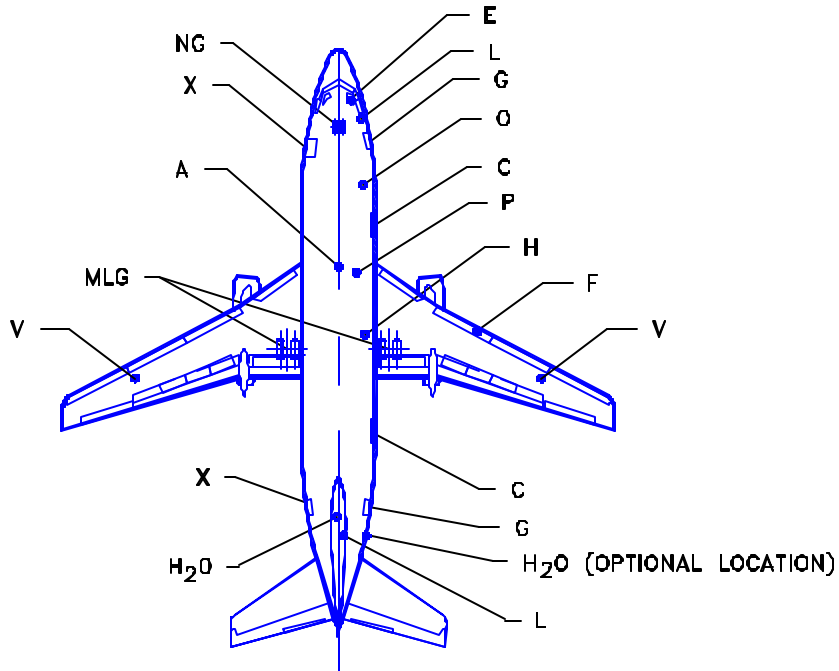
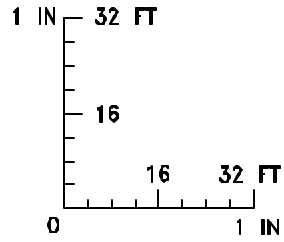

LEGEND

- A AIR CONDITIONING
- C CARGO DOOR
- E ELECTRICAL
- F FUEL
- G SERVICE DOOR
- H₂O POTABLE WATER
- L LAVATORY SERVICE
- MLG MAIN LANDING GEAR
- NG NOSE LANDING GEAR
- O OXYGEN
- P PNEUMATIC (AIR START)
- V FUEL VENT
- X PASSENGER DOOR

NOTE: FOR TURNING RADIUS DATA
SEE SECTIONS 4.2 AND 4.3

NOTE: WHEN PRINTING THIS DRAWING, MAKE SURE TO ADJUST FOR PROPER SCALING

9.6.1 SCALED DRAWING - 1 IN = 32 FT
MODEL 737-200

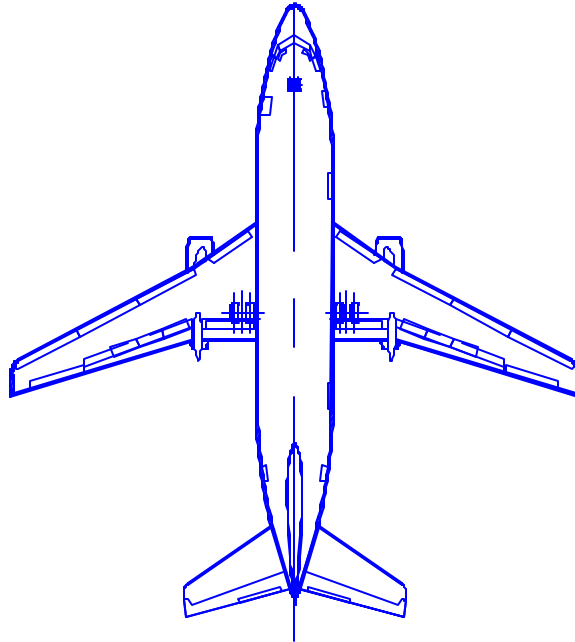
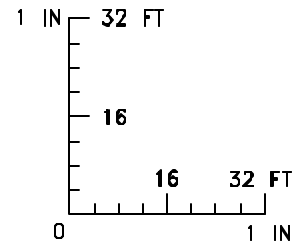

NOTE: WHEN PRINTING THIS DRAWING, MAKE SURE TO ADJUST FOR PROPER SCALING

9.6.2 SCALED DRAWING - 1 IN = 32 FT
MODEL 737-200

D6-58325-6

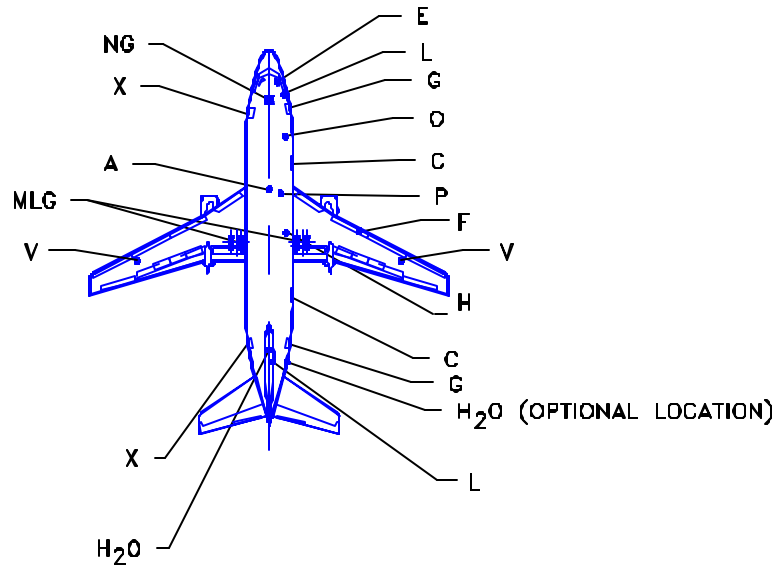
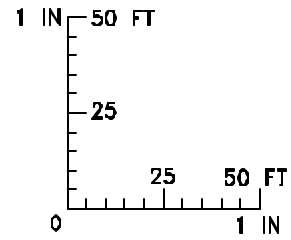

LEGEND

- A AIR CONDITIONING
- C CARGO DOOR
- E ELECTRICAL
- F FUEL
- G SERVICE DOOR
- H O POTABLE WATER
- L LAVATORY SERVICE
- MLG MAIN LANDING GEAR
- NG NOSE LANDING GEAR
- O OXYGEN
- P PNEUMATIC (AIR START)
- V FUEL VENT
- X PASSENGER DOOR

NOTE: FOR TURNING RADIUS DATA
SEE SECTIONS 4.2 AND 4.3

NOTE: WHEN PRINTING THIS DRAWING, MAKE SURE TO ADJUST FOR PROPER SCALING

9.7.1 SCALED DRAWING - 1 IN = 50 FT
MODEL 737-200

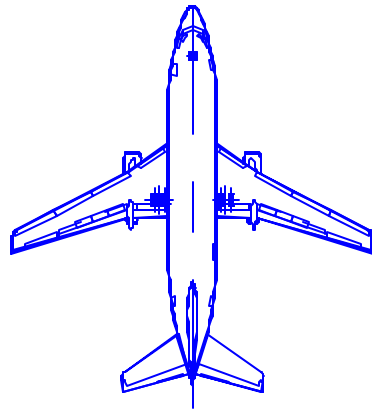
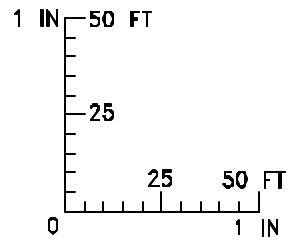

NOTE: WHEN PRINTING THIS DRAWING, MAKE SURE TO ADJUST FOR PROPER SCALING

9.7.2 SCALED DRAWING - 1 IN = 50 FT
MODEL 737-200

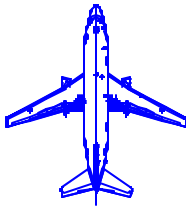
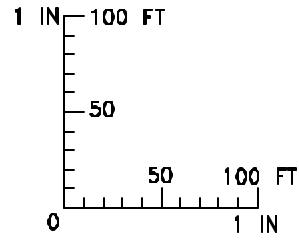

NOTE:

SEE CORRESPONDING PAGE FOR 1 IN = 32 FT
FOR IDENTIFICATIONS OF SERVICE POINTS

LEGEND

A AIR CONDITIONING
 C CARGO DOOR
 E ELECTRICAL
 F FUEL
 G SERVICE DOOR
 H O POTABLE WATER
 L LAVATORY SERVICE
 MLG MAIN LANDING GEAR
 NG NOSE LANDING GEAR
 O OXYGEN
 P PNEUMATIC (AIR START)
 V FUEL VENT
 X PASSENGER DOOR

NOTE: FOR TURNING RADIUS DATA
 SEE SECTIONS 4.2 AND 4.3

NOTE: WHEN PRINTING THIS DRAWING, MAKE SURE TO ADJUST FOR PROPER SCALING

9.8.1 SCALED DRAWING - 1 IN = 100 FT
 MODEL 737-200

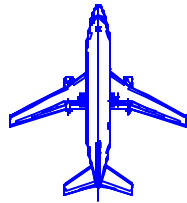
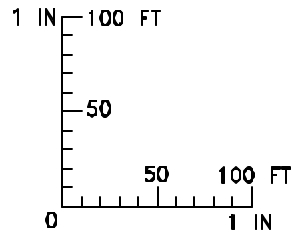

NOTE: WHEN PRINTING THIS DRAWING, MAKE SURE TO ADJUST FOR PROPER SCALING

9.8.2 SCALED DRAWING - 1 IN = 100 FT
MODEL 737-200

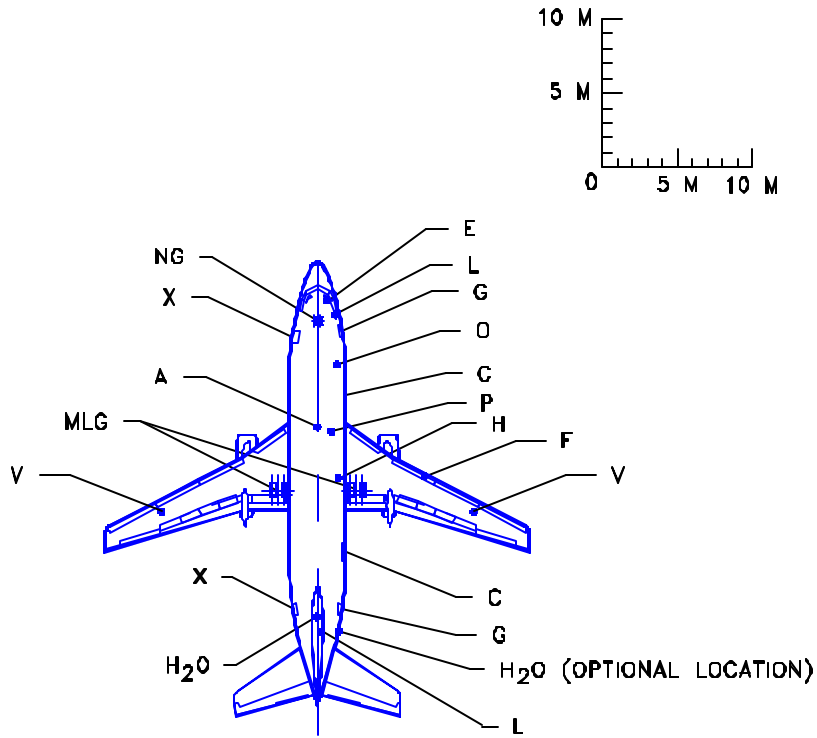

LEGEND

- A AIR CONDITIONING
- C CARGO DOOR
- E ELECTRICAL
- F FUEL
- G SERVICE DOOR
- H O POTABLE WATER
- L LAVATORY SERVICE
- MLG MAIN LANDING GEAR
- NG NOSE LANDING GEAR
- O OXYGEN
- P PNEUMATIC (AIR START)
- V FUEL VENT
- X PASSENGER DOOR

NOTE: FOR TURNING RADIUS DATA
SEE SECTIONS 4.2 AND 4.3

NOTE: WHEN PRINTING THIS DRAWING, MAKE SURE TO ADJUST FOR PROPER SCALING

9.9.1 SCALED DRAWING – 1:500
MODEL 737-200

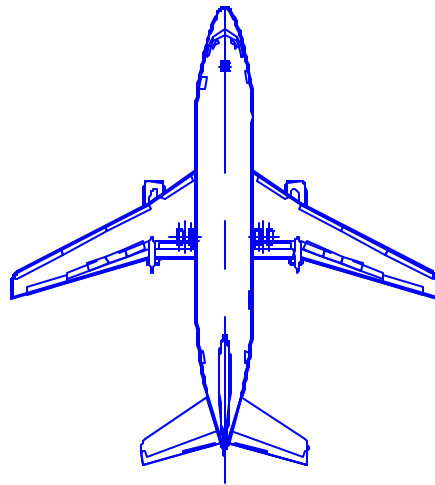
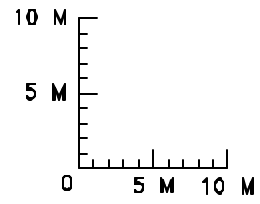

NOTE: WHEN PRINTING THIS DRAWING, MAKE SURE TO ADJUST FOR PROPER SCALING

9.9.2 SCALED DRAWING – 1:500
MODEL 737-200

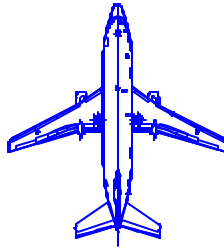
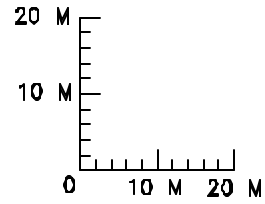

NOTE:

SEE CORRESPONDING PAGE FOR 1 IN = 32 FT
FOR IDENTIFICATIONS OF SERVICE POINTS

LEGEND

- A AIR CONDITIONING
- C CARGO DOOR
- E ELECTRICAL
- F FUEL
- G SERVICE DOOR
- H O POTABLE WATER
- L LAVATORY SERVICE
- MLG MAIN LANDING GEAR
- NG NOSE LANDING GEAR
- O OXYGEN
- P PNEUMATIC (AIR START)
- V FUEL VENT
- X PASSENGER DOOR

NOTE: FOR TURNING RADIUS DATA
SEE SECTIONS 4.2 AND 4.3

NOTE: WHEN PRINTING THIS DRAWING, MAKE SURE TO ADJUST FOR PROPER SCALING

9.10.1 SCALED DRAWING – 1:1000
MODEL 737-200

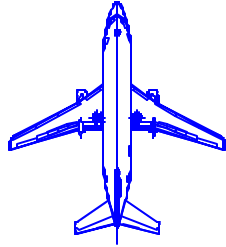
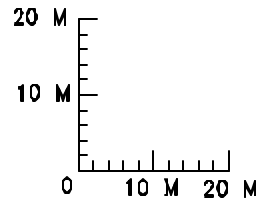

NOTE: WHEN PRINTING THIS DRAWING, MAKE SURE TO ADJUST FOR PROPER SCALING

9.10.2 SCALED DRAWING – 1:1000
MODEL 737-200

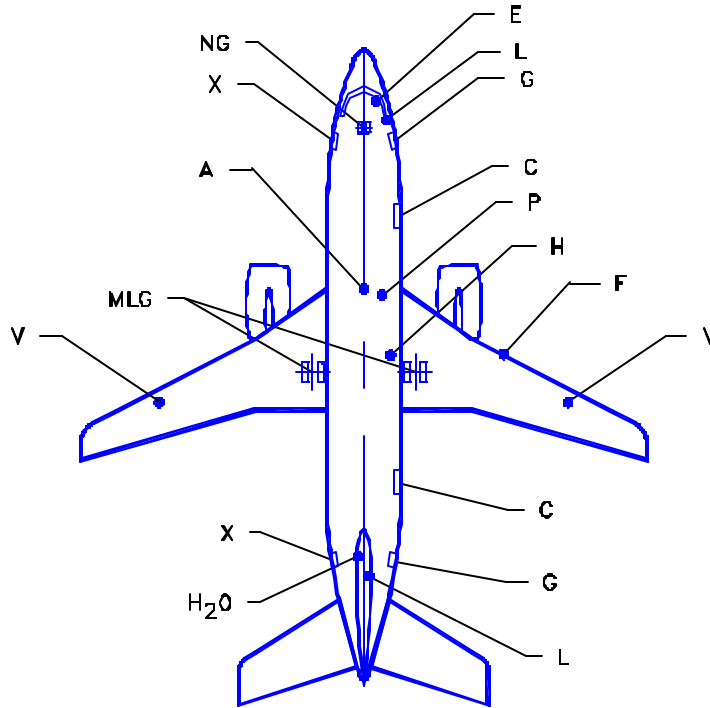
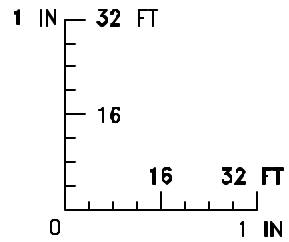

LEGEND

- A AIR CONDITIONING
- C CARGO DOOR
- E ELECTRICAL
- F FUEL
- G SERVICE DOOR
- H HYDRAULIC
- H₂O POTABLE WATER
- L LAVATORY SERVICE
- MLG MAIN LANDING GEAR
- NG NOSE LANDING GEAR
- P PNEUMATIC (AIR START)
- V FUEL VENT
- X PASSENGER DOOR

NOTE: FOR TURNING RADIUS DATA
SEE SECTIONS 4.2 AND 4.3

NOTE: WHEN PRINTING THIS DRAWING, MAKE SURE TO ADJUST FOR PROPER SCALING

9.11.1 SCALED DRAWING - 1 IN = 32 FT
MODEL 737-300

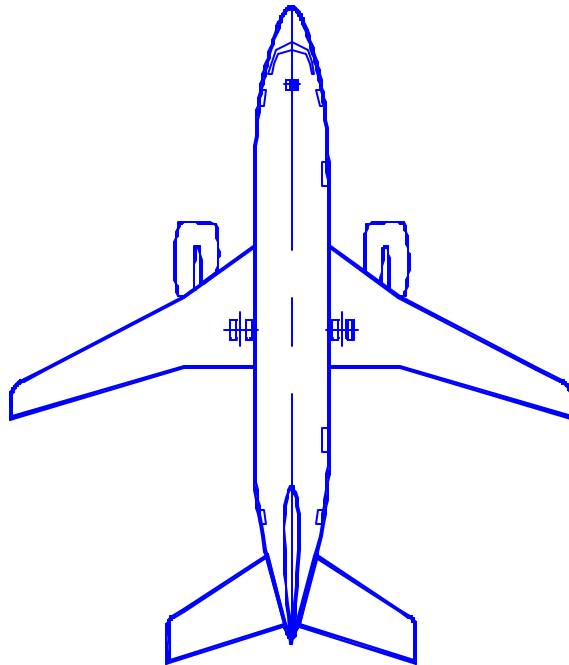
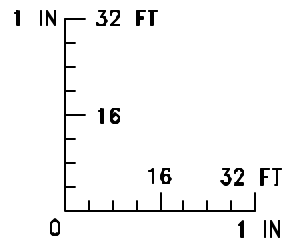

NOTE: WHEN PRINTING THIS DRAWING, MAKE SURE TO ADJUST FOR PROPER SCALING

9.11.2 SCALED DRAWING - 1 IN = 32 FT
MODEL 737-300

D6-58325-6

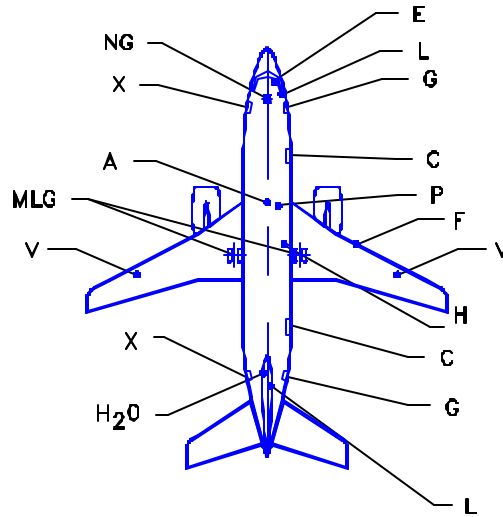
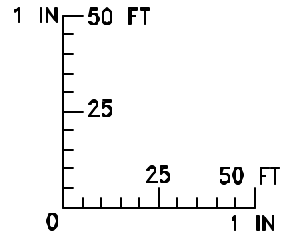

LEGEND

- A AIR CONDITIONING
- C CARGO DOOR
- E ELECTRICAL
- F FUEL
- G SERVICE DOOR
- H HYDRAULIC
- H₂O POTABLE WATER
- L LAVATORY SERVICE
- MLG MAIN LANDING GEAR
- NG NOSE LANDING GEAR
- P PNEUMATIC (AIR START)
- V FUEL VENT
- X PASSENGER DOOR

NOTE: FOR TURNING RADIUS DATA
SEE SECTIONS 4.2 AND 4.3

NOTE: WHEN PRINTING THIS DRAWING, MAKE SURE TO ADJUST FOR PROPER SCALING

9.12.1 SCALED DRAWING - 1 IN = 50 FT
MODEL 737-300

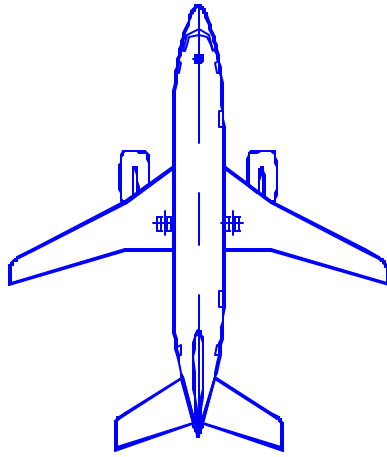
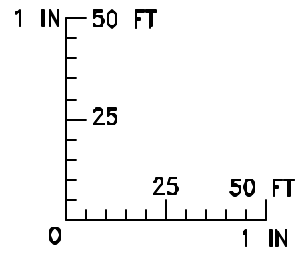

NOTE: WHEN PRINTING THIS DRAWING, MAKE SURE TO ADJUST FOR PROPER SCALING

9.12.2 SCALED DRAWING - 1 IN = 50 FT
MODEL 737-300

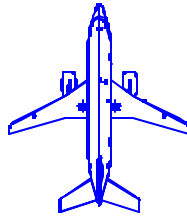
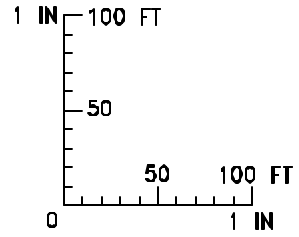

NOTE:

**SEE CORRESPONDING PAGE FOR 1 IN = 32 FT
FOR IDENTIFICATIONS OF SERVICE POINTS**

LEGEND

- A AIR CONDITIONING**
- C CARGO DOOR**
- E ELECTRICAL**
- F FUEL**
- G SERVICE DOOR**
- H HYDRAULIC**
- H₂O POTABLE WATER**
- L LAVATORY SERVICE**
- MLG MAIN LANDING GEAR**
- NG NOSE LANDING GEAR**
- P PNEUMATIC (AIR START)**
- V FUEL VENT**
- X PASSENGER DOOR**

**NOTE: FOR TURNING RADIUS DATA
SEE SECTIONS 4.2 AND 4.3**

NOTE: WHEN PRINTING THIS DRAWING, MAKE SURE TO ADJUST FOR PROPER SCALING

9.13.1 SCALED DRAWING - 1 IN = 100 FT
MODEL 737-300

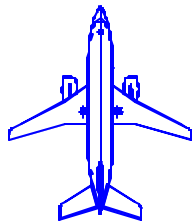
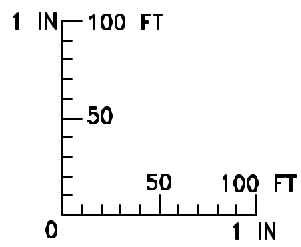

NOTE: WHEN PRINTING THIS DRAWING, MAKE SURE TO ADJUST FOR PROPER SCALING

9.13.2 SCALED DRAWING - 1 IN = 100 FT
MODEL 737-300

D6-58325-6

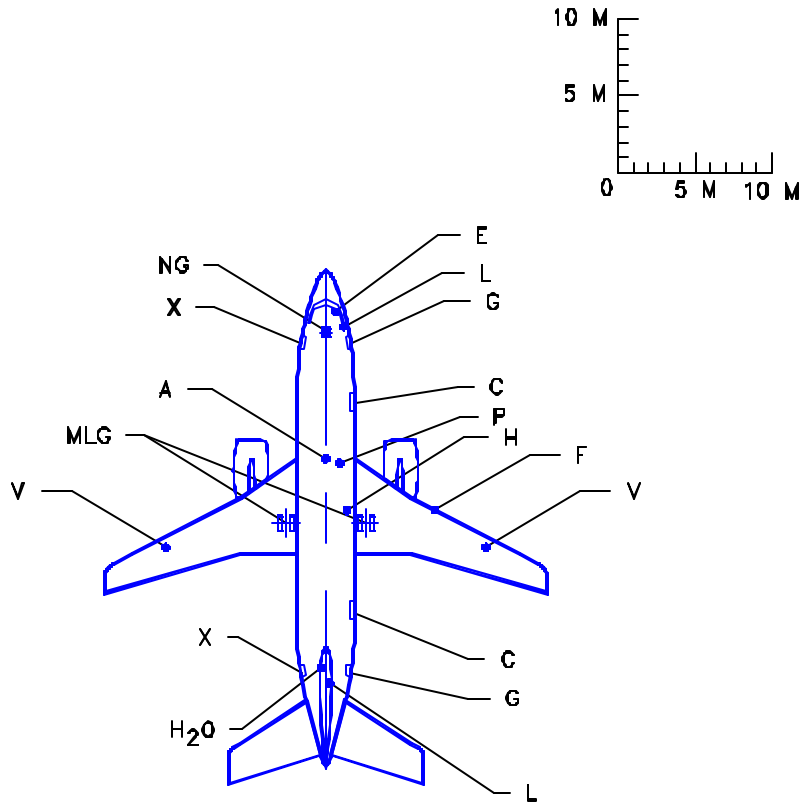

LEGEND

- A AIR CONDITIONING
- C CARGO DOOR
- E ELECTRICAL
- F FUEL
- G SERVICE DOOR
- H HYDRAULIC
- H₂O POTABLE WATER
- L LAVATORY SERVICE
- MLG MAIN LANDING GEAR
- NG NOSE LANDING GEAR
- P PNEUMATIC (AIR START)
- V FUEL VENT
- X PASSENGER DOOR

NOTE: FOR TURNING RADIUS DATA
SEE SECTIONS 4.2 AND 4.3

NOTE: WHEN PRINTING THIS DRAWING, MAKE SURE TO ADJUST FOR PROPER SCALING

9.14.1 SCALED DRAWING – 1:500
MODEL 737-300

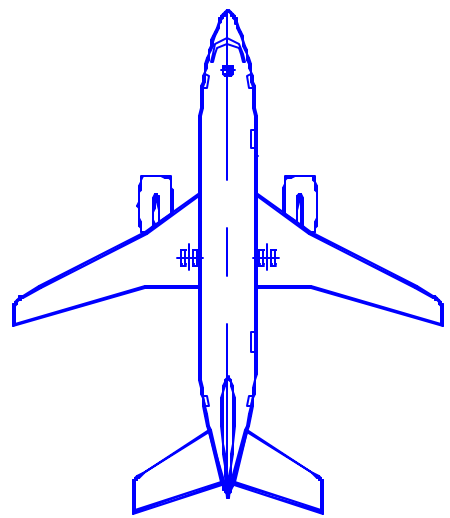
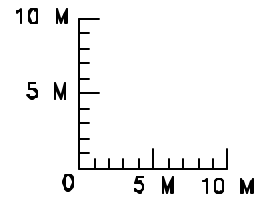

NOTE: WHEN PRINTING THIS DRAWING, MAKE SURE TO ADJUST FOR PROPER SCALING

9.14.2 SCALED DRAWING – 1:500
MODEL 737-300

D6-58325-6

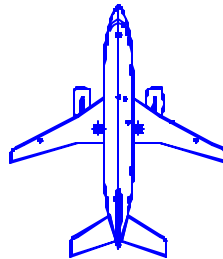
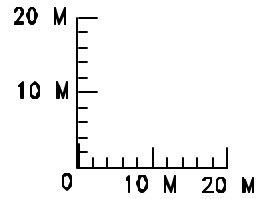

NOTE:

SEE CORRESPONDING PAGE FOR 1 IN = 32 FT
FOR IDENTIFICATIONS OF SERVICE POINTS

LEGEND

- A AIR CONDITIONING
- C CARGO DOOR
- E ELECTRICAL
- F FUEL
- G SERVICE DOOR
- H₂O POTABLE WATER
- L LAVATORY SERVICE
- MLG MAIN LANDING GEAR
- NG NOSE LANDING GEAR
- O OXYGEN
- P PNEUMATIC (AIR START)
- V FUEL VENT
- X PASSENGER DOOR

NOTE: FOR TURNING RADIUS DATA
SEE SECTIONS 4.2 AND 4.3

NOTE: WHEN PRINTING THIS DRAWING, MAKE SURE TO ADJUST FOR PROPER SCALING

9.15.1 SCALED DRAWING – 1:1000
MODEL 737-300

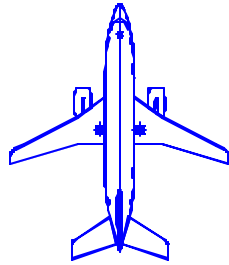
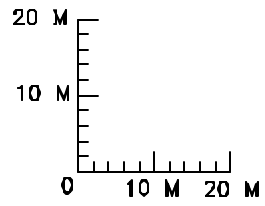

NOTE: WHEN PRINTING THIS DRAWING, MAKE SURE TO ADJUST FOR PROPER SCALING

9.15.2 SCALED DRAWING – 1:1000

MODEL 737-300

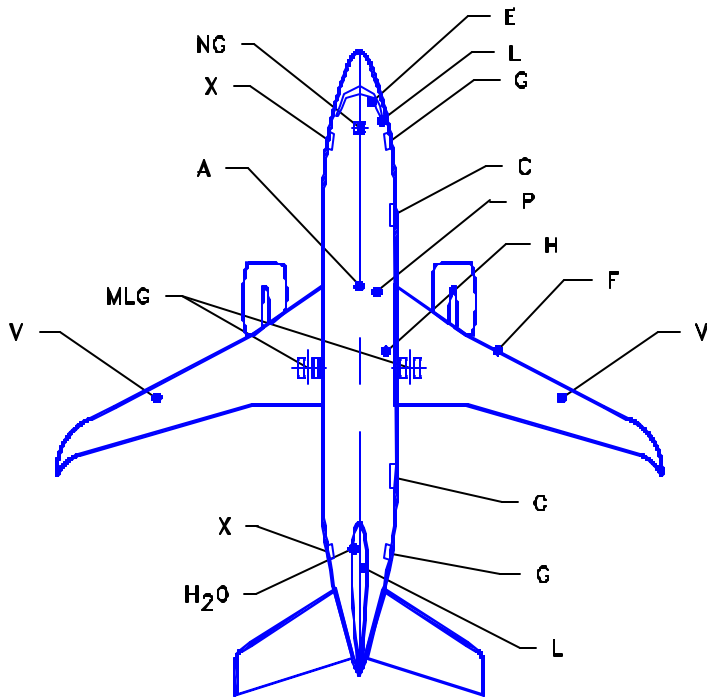
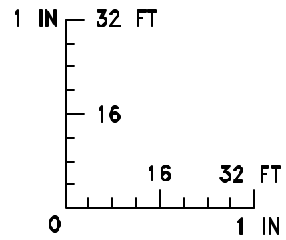

LEGEND

- A AIR CONDITIONING
- C CARGO DOOR
- E ELECTRICAL
- F FUEL
- G SERVICE DOOR
- H HYDRAULIC
- H₂O POTABLE WATER
- L LAVATORY SERVICE
- MLG MAIN LANDING GEAR
- NG NOSE LANDING GEAR
- P PNEUMATIC (AIR START)
- V FUEL VENT
- X PASSENGER DOOR

NOTE: FOR TURNING RADIUS DATA
SEE SECTIONS 4.2 AND 4.3

NOTE: WHEN PRINTING THIS DRAWING, MAKE SURE TO ADJUST FOR PROPER SCALING

9.16.1 SCALED DRAWING - 1 IN = 32 FT
MODEL 737-300 WITH WINGLETS

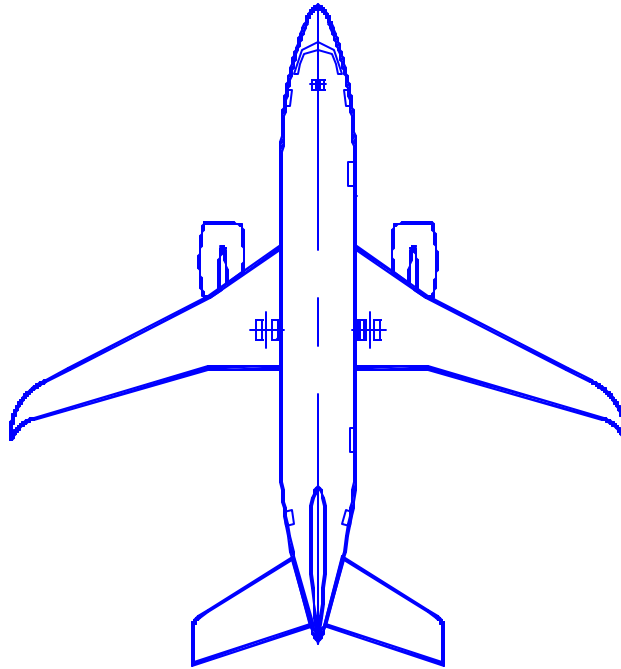
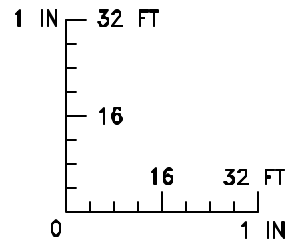

NOTE: WHEN PRINTING THIS DRAWING, MAKE SURE TO ADJUST FOR PROPER SCALING

9.16.2 SCALED DRAWING - 1 IN = 32 FT
MODEL 737-300 WITH WINGLETS

D6-58325-6

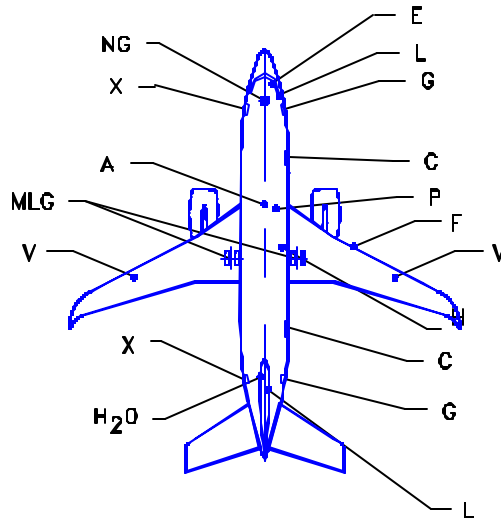
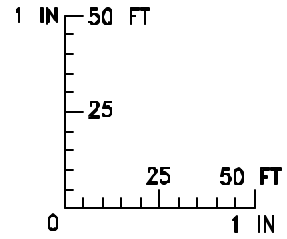

LEGEND

- A** AIR CONDITIONING
- C** CARGO DOOR
- E** ELECTRICAL
- F** FUEL
- G** SERVICE DOOR
- H** HYDRAULIC
- H₂O** POTABLE WATER
- L** LAVATORY SERVICE
- MLG** MAIN LANDING GEAR
- NG** NOSE LANDING GEAR
- P** PNEUMATIC (AIR START)
- V** FUEL VENT
- X** PASSENGER DOOR

NOTE: FOR TURNING RADIUS DATA
SEE SECTIONS 4.2 AND 4.3

NOTE: WHEN PRINTING THIS DRAWING, MAKE SURE TO ADJUST FOR PROPER SCALING

9.17.1 SCALED DRAWING - 1 IN = 50 FT
MODEL 737-300 WITH WINGLETS

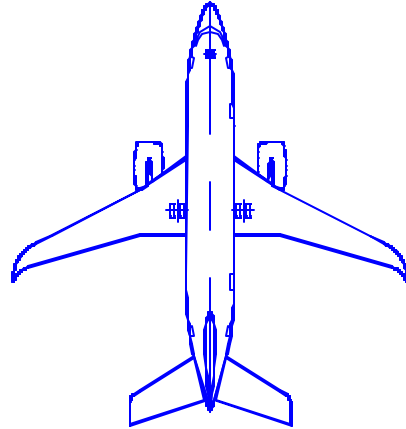
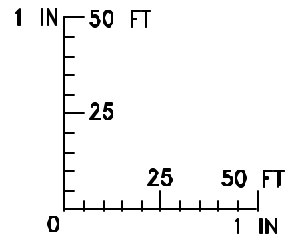

NOTE: WHEN PRINTING THIS DRAWING, MAKE SURE TO ADJUST FOR PROPER SCALING

9.17.2 SCALED DRAWING - 1 IN = 50 FT
MODEL 737-300 WITH WINGLETS

D6-58325-6

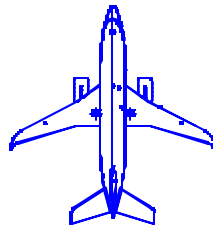
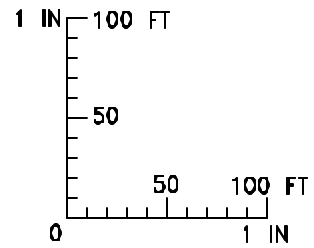

NOTE:

SEE CORRESPONDING PAGE FOR 1 IN = 32 FT
FOR IDENTIFICATIONS OF SERVICE POINTS

LEGEND

- A AIR CONDITIONING
- C CARGO DOOR
- E ELECTRICAL
- F FUEL
- G SERVICE DOOR
- H HYDRAULIC
- H₂O POTABLE WATER
- L LAVATORY SERVICE
- MLG MAIN LANDING GEAR
- NG NOSE LANDING GEAR
- P PNEUMATIC (AIR START)
- V FUEL VENT
- X PASSENGER DOOR

NOTE: FOR TURNING RADIUS DATA
SEE SECTIONS 4.2 AND 4.3

NOTE: WHEN PRINTING THIS DRAWING, MAKE SURE TO ADJUST FOR PROPER SCALING

9.18.1 SCALED DRAWING - 1 IN = 100 FT
MODEL 737-300 WITH WINGLETS

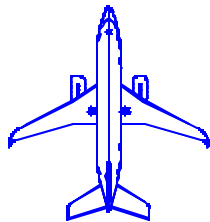
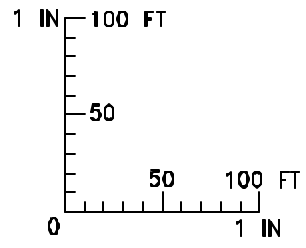

NOTE: WHEN PRINTING THIS DRAWING, MAKE SURE TO ADJUST FOR PROPER SCALING

9.18.2 SCALED DRAWING - 1 IN = 100 FT
MODEL 737-300 WITH WINGLETS

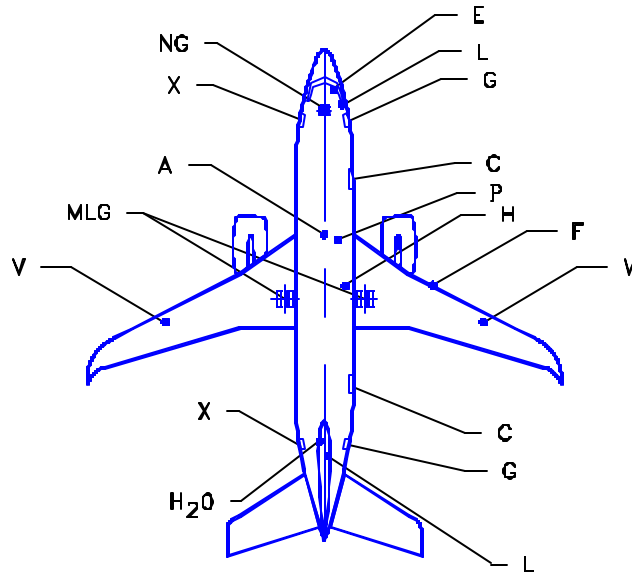
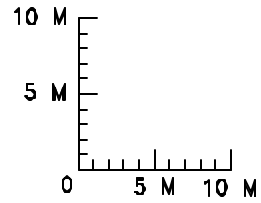

LEGEND

- A AIR CONDITIONING
- C CARGO DOOR
- E ELECTRICAL
- F FUEL
- G SERVICE DOOR
- H HYDRAULIC
- H₂O POTABLE WATER
- L LAVATORY SERVICE
- MLG MAIN LANDING GEAR
- NG NOSE LANDING GEAR
- P PNEUMATIC (AIR START)
- V FUEL VENT
- X PASSENGER DOOR

NOTE: FOR TURNING RADIUS DATA
SEE SECTIONS 4.2 AND 4.3

NOTE: WHEN PRINTING THIS DRAWING, MAKE SURE TO ADJUST FOR PROPER SCALING

9.19.1 SCALED DRAWING – 1:500
MODEL 737-300 WITH WINGLETS

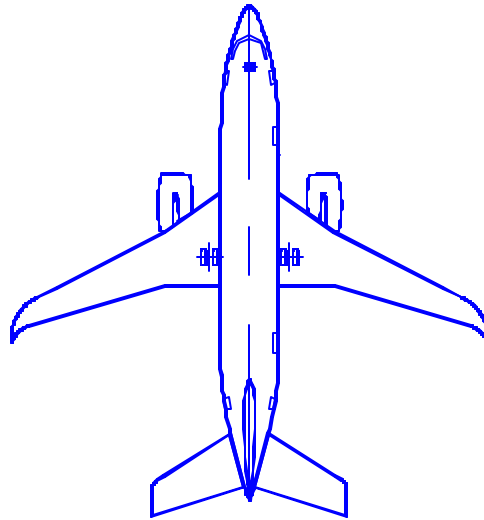
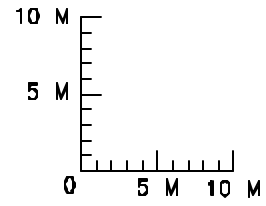

NOTE: WHEN PRINTING THIS DRAWING, MAKE SURE TO ADJUST FOR PROPER SCALING

9.19.2 SCALED DRAWING – 1:500
MODEL 737-300 WITH WINGLETS

D6-58325-6

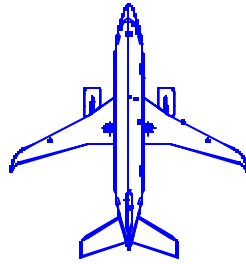
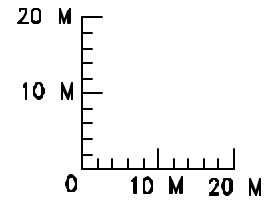

NOTE:

SEE CORRESPONDING PAGE FOR 1 IN = 32 FT
FOR IDENTIFICATIONS OF SERVICE POINTS

LEGEND

A	AIR CONDITIONING
C	CARGO DOOR
E	ELECTRICAL
F	FUEL
G	SERVICE DOOR
H ₂ O	POTABLE WATER
L	LAVATORY SERVICE
MLG	MAIN LANDING GEAR
NG	NOSE LANDING GEAR
O	OXYGEN
P	PNEUMATIC (AIR START)
V	FUEL VENT
X	PASSENGER DOOR

NOTE: FOR TURNING RADIUS DATA
SEE SECTIONS 4.2 AND 4.3

NOTE: WHEN PRINTING THIS DRAWING, MAKE SURE TO ADJUST FOR PROPER SCALING

9.20.1 SCALED DRAWING – 1:1000
MODEL 737-300 WITH WINGLETS

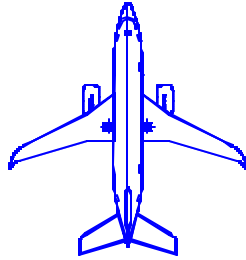
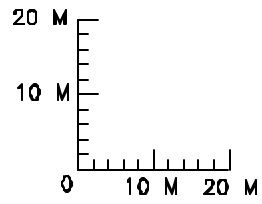

NOTE: WHEN PRINTING THIS DRAWING, MAKE SURE TO ADJUST FOR PROPER SCALING

9.20.2 SCALED DRAWING – 1:1000
MODEL 737-300 WITH WINGLETS

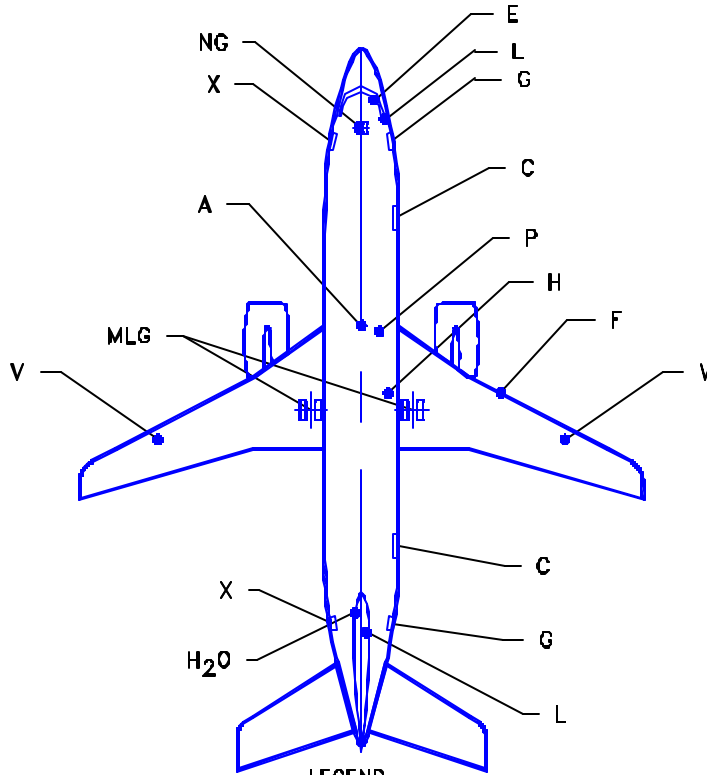
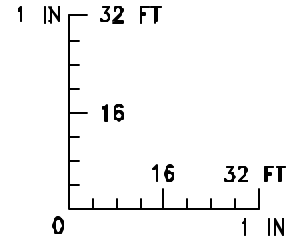

LEGEND

- A AIR CONDITIONING
- C CARGO DOOR
- E ELECTRICAL
- F FUEL
- G SERVICE DOOR
- H HYDRAULIC
- H₂O POTABLE WATER
- L LAVATORY SERVICE
- MLG MAIN LANDING GEAR
- NG NOSE LANDING GEAR
- P PNEUMATIC (AIR START)
- V FUEL VENT
- X PASSENGER DOOR

NOTE: FOR TURNING RADIUS DATA
SEE SECTIONS 4.2 AND 4.3

NOTE: WHEN PRINTING THIS DRAWING, MAKE SURE TO ADJUST FOR PROPER SCALING

9.21.1 SCALED DRAWING - 1 IN = 32 FT
MODEL 737-400

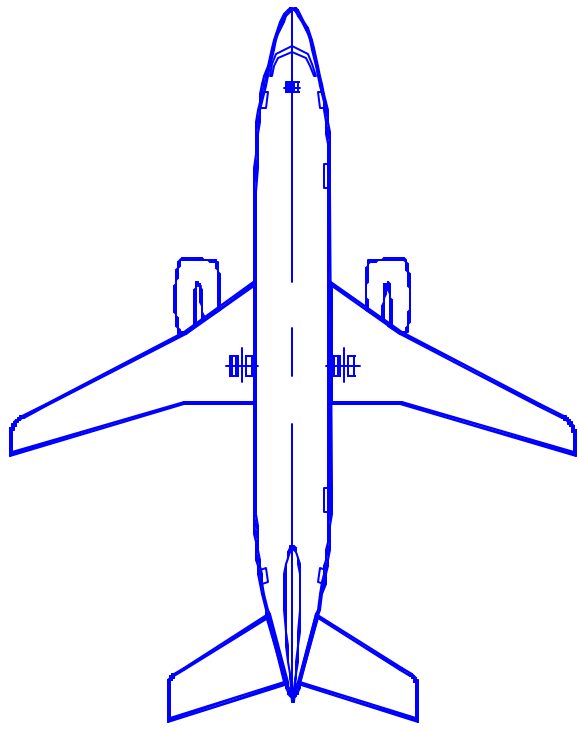
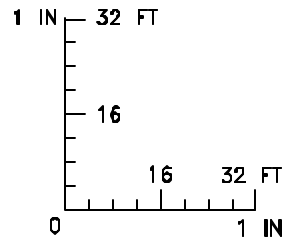

NOTE: WHEN PRINTING THIS DRAWING, MAKE SURE TO ADJUST FOR PROPER SCALING

9.21.2 SCALED DRAWING - 1 IN = 32 FT
MODEL 737-400

D6-58325-6

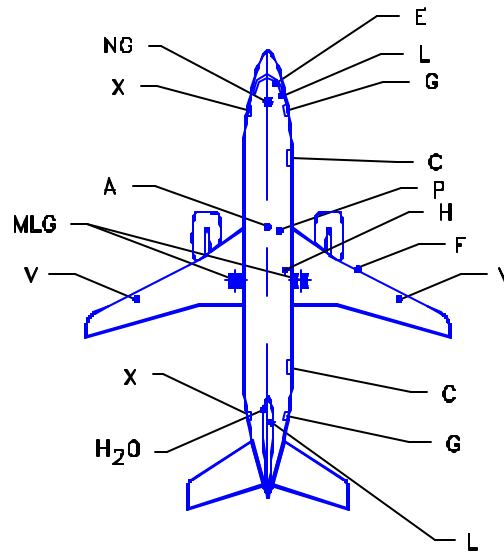
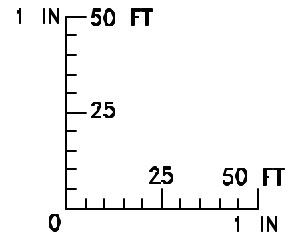

LEGEND

- A AIR CONDITIONING
- C CARGO DOOR
- E ELECTRICAL
- F FUEL
- G SERVICE DOOR
- H HYDRAULIC
- H₂O POTABLE WATER
- L LAVATORY SERVICE
- MLG MAIN LANDING GEAR
- NG NOSE LANDING GEAR
- P PNEUMATIC (AIR START)
- V FUEL VENT
- X PASSENGER DOOR

NOTE: FOR TURNING RADIUS DATA
SEE SECTIONS 4.2 AND 4.3

NOTE: WHEN PRINTING THIS DRAWING, MAKE SURE TO ADJUST FOR PROPER SCALING

9.22.1 SCALED DRAWING - 1 IN = 50 FT
MODEL 737-400

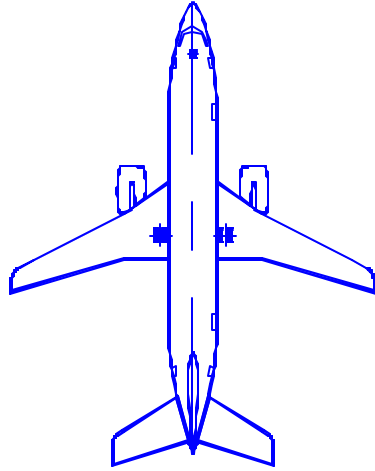
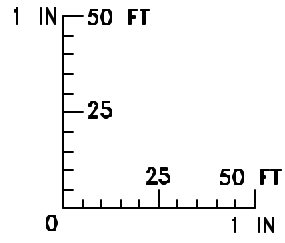

NOTE: WHEN PRINTING THIS DRAWING, MAKE SURE TO ADJUST FOR PROPER SCALING

9.22.2 SCALED DRAWING - 1 IN = 50 FT
MODEL 737-400

D6-58325-6

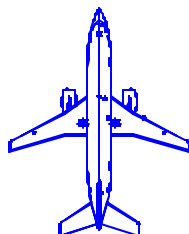
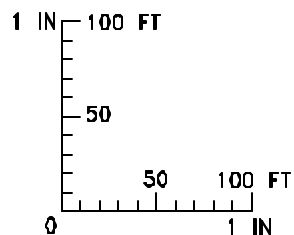

NOTE:

SEE CORRESPONDING PAGE FOR 1 IN = 32 FT
FOR IDENTIFICATIONS OF SERVICE POINTS

LEGEND

A	AIR CONDITIONING
C	CARGO DOOR
E	ELECTRICAL
F	FUEL
G	SERVICE DOOR
H	HYDRAULIC
H ₂ O	POTABLE WATER
L	LAVATORY SERVICE
MLG	MAIN LANDING GEAR
NG	NOSE LANDING GEAR
P	PNEUMATIC (AIR START)
V	FUEL VENT
X	PASSENGER DOOR

NOTE: FOR TURNING RADIUS DATA
SEE SECTIONS 4.2 AND 4.3

NOTE: WHEN PRINTING THIS DRAWING, MAKE SURE TO ADJUST FOR PROPER SCALING

9.23.1 SCALED DRAWING - 1 IN = 100 FT

MODEL 737-400

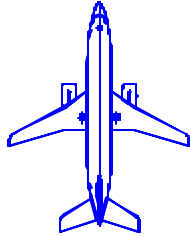
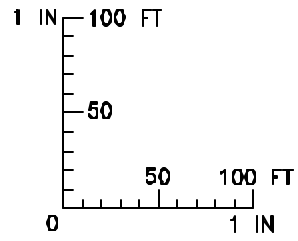

NOTE: WHEN PRINTING THIS DRAWING, MAKE SURE TO ADJUST FOR PROPER SCALING

9.23.2 SCALED DRAWING - 1 IN = 100 FT
MODEL 737-400

D6-58325-6

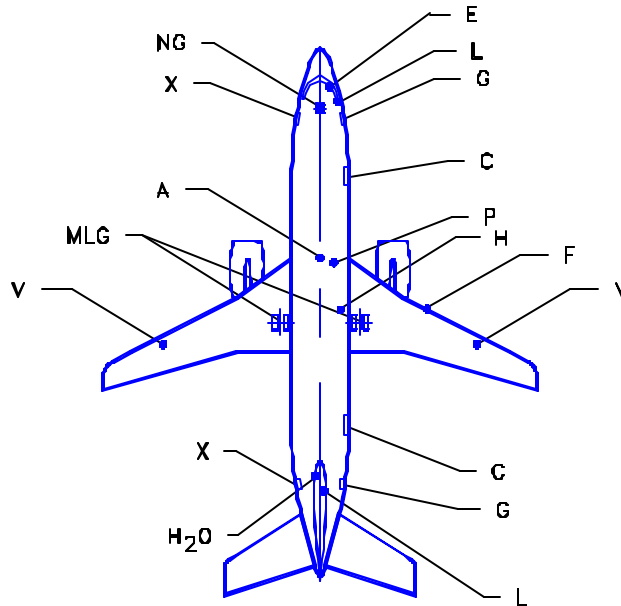
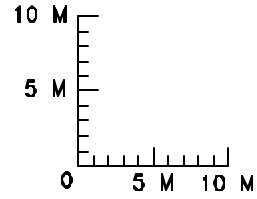

LEGEND

- A AIR CONDITIONING
- C CARGO DOOR
- E ELECTRICAL
- F FUEL
- G SERVICE DOOR
- H HYDRAULIC
- H₂O POTABLE WATER
- L LAVATORY SERVICE
- MLG MAIN LANDING GEAR
- NG NOSE LANDING GEAR
- P PNEUMATIC (AIR START)
- V FUEL VENT
- X PASSENGER DOOR

NOTE: FOR TURNING RADIUS DATA
SEE SECTIONS 4.2 AND 4.3

NOTE: WHEN PRINTING THIS DRAWING, MAKE SURE TO ADJUST FOR PROPER SCALING

9.24.1 SCALED DRAWING – 1:500
MODEL 737-100

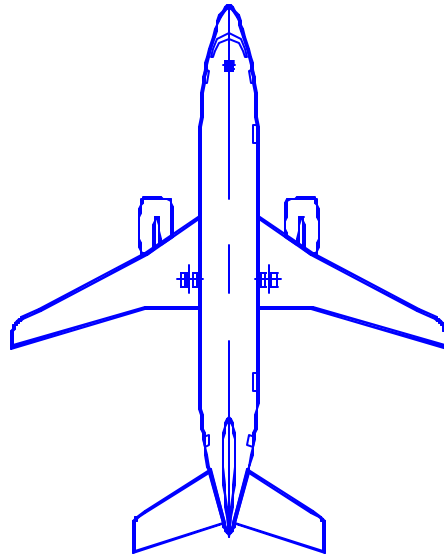
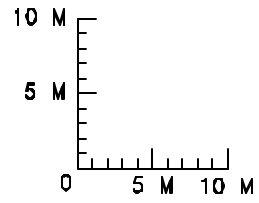

NOTE: WHEN PRINTING THIS DRAWING, MAKE SURE TO ADJUST FOR PROPER SCALING

9.24.2 SCALED DRAWING – 1:500
MODEL 737-100

D6-58325-6

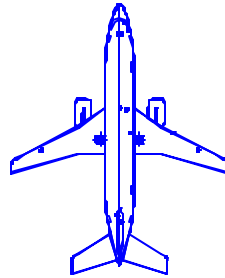
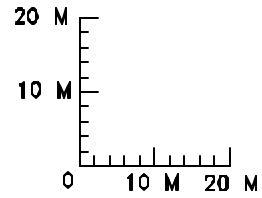

NOTE:

SEE CORRESPONDING PAGE FOR 1 IN = 32 FT
FOR IDENTIFICATIONS OF SERVICE POINTS

LEGEND

A AIR CONDITIONING
C CARGO DOOR
E ELECTRICAL
F FUEL
G SERVICE DOOR
H₂O POTABLE WATER
L LAVATORY SERVICE
MLG MAIN LANDING GEAR
NG NOSE LANDING GEAR
O OXYGEN
P PNEUMATIC (AIR START)
V FUEL VENT
X PASSENGER DOOR

NOTE: FOR TURNING RADIUS DATA
SEE SECTIONS 4.2 AND 4.3

NOTE: WHEN PRINTING THIS DRAWING, MAKE SURE TO ADJUST FOR PROPER SCALING

9.25.1 SCALED DRAWING – 1:1000
MODEL 737-400

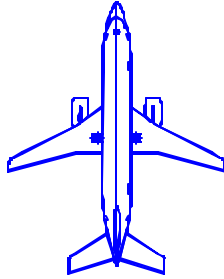
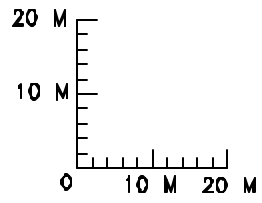

NOTE: WHEN PRINTING THIS DRAWING, MAKE SURE TO ADJUST FOR PROPER SCALING

9.25.2 SCALED DRAWING – 1:1000
MODEL 737-400

D6-58325-6

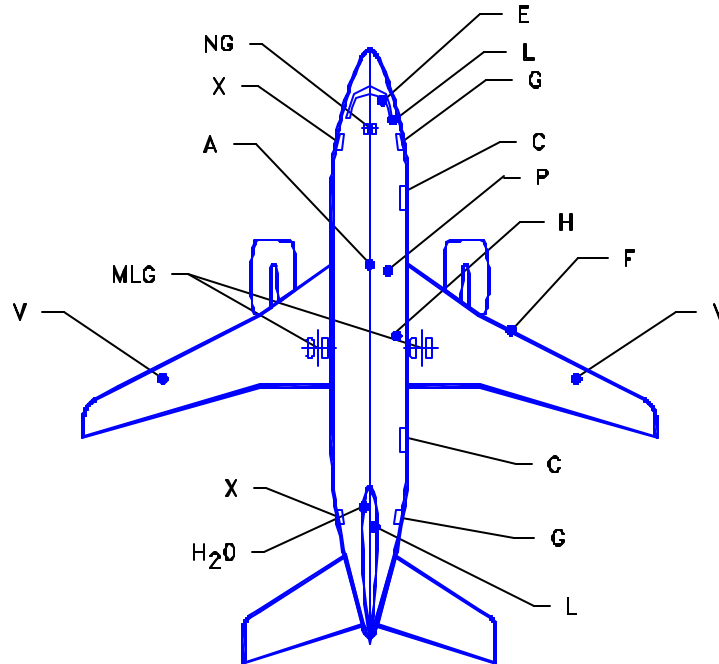
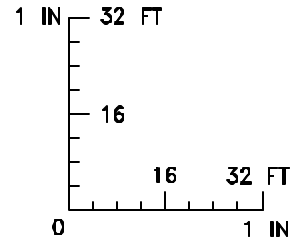

LEGEND

- A** AIR CONDITIONING
- C** CARGO DOOR
- E** ELECTRICAL
- F** FUEL
- G** SERVICE DOOR
- H** HYDRAULIC
- H₂O** POTABLE WATER
- L** LAVATORY SERVICE
- MLG** MAIN LANDING GEAR
- NG** NOSE LANDING GEAR
- P** PNEUMATIC (AIR START)
- V** FUEL VENT
- X** PASSENGER DOOR

NOTE: FOR TURNING RADIUS DATA
SEE SECTIONS 4.2 AND 4.3

NOTE: WHEN PRINTING THIS DRAWING, MAKE SURE TO ADJUST FOR PROPER SCALING

9.26.1 SCALED DRAWING - 1 IN = 32 FT
MODEL 737-500

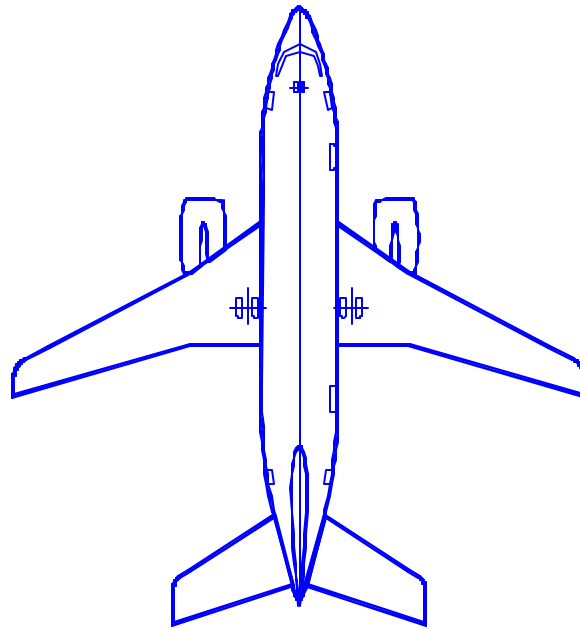
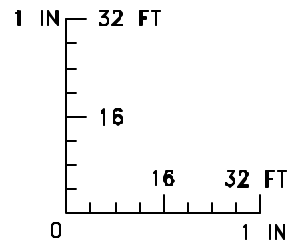

NOTE: WHEN PRINTING THIS DRAWING, MAKE SURE TO ADJUST FOR PROPER SCALING

9.26.2 SCALED DRAWING - 1 IN = 32 FT
MODEL 737-500

D6-58325-6

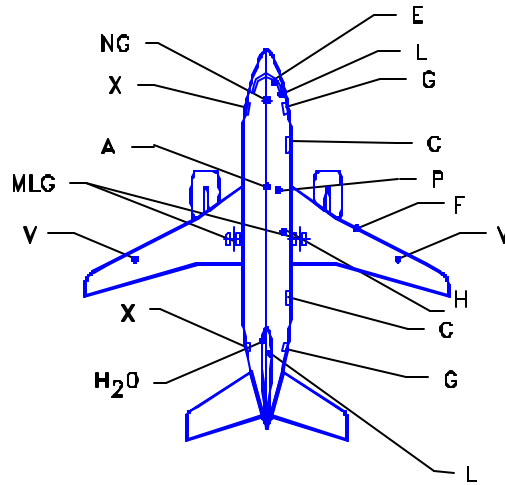
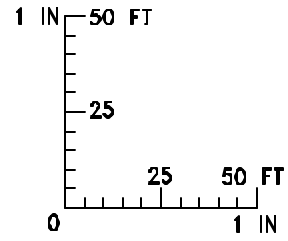

LEGEND

- A AIR CONDITIONING
- C CARGO DOOR
- E ELECTRICAL
- F FUEL
- G SERVICE DOOR
- H HYDRAULIC
- H₂O POTABLE WATER
- L LAVATORY SERVICE
- MLG MAIN LANDING GEAR
- NG NOSE LANDING GEAR
- P PNEUMATIC (AIR START)
- V FUEL VENT
- X PASSENGER DOOR

NOTE: FOR TURNING RADIUS DATA
SEE SECTIONS 4.2 AND 4.3

NOTE: WHEN PRINTING THIS DRAWING, MAKE SURE TO ADJUST FOR PROPER SCALING

9.27.1 SCALED DRAWING - 1 IN = 50 FT
MODEL 737-500

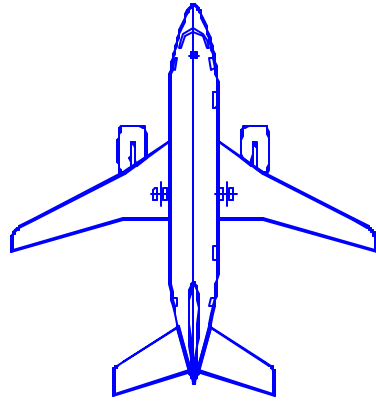
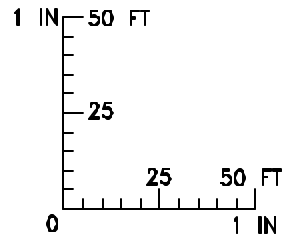

NOTE: WHEN PRINTING THIS DRAWING, MAKE SURE TO ADJUST FOR PROPER SCALING

9.27.2 SCALED DRAWING - 1 IN = 50 FT
MODEL 737-500

D6-58325-6

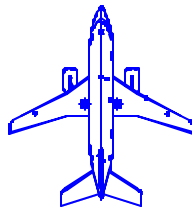
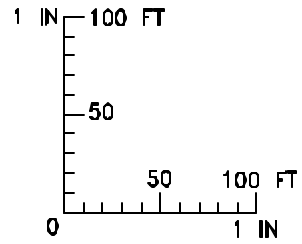

NOTE:

SEE CORRESPONDING PAGE FOR 1 IN = 32 FT
FOR IDENTIFICATIONS OF SERVICE POINTS

LEGEND

- A AIR CONDITIONING
- C CARGO DOOR
- E ELECTRICAL
- F FUEL
- G SERVICE DOOR
- H HYDRAULIC
- H₂O POTABLE WATER
- L LAVATORY SERVICE
- MLG MAIN LANDING GEAR
- NG NOSE LANDING GEAR
- P PNEUMATIC (AIR START)
- V FUEL VENT
- X PASSENGER DOOR

NOTE: FOR TURNING RADIUS DATA
SEE SECTIONS 4.2 AND 4.3

NOTE: WHEN PRINTING THIS DRAWING, MAKE SURE TO ADJUST FOR PROPER SCALING

9.28.1 SCALED DRAWING - 1 IN = 100 FT
MODEL 737-500

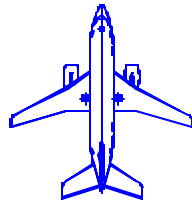
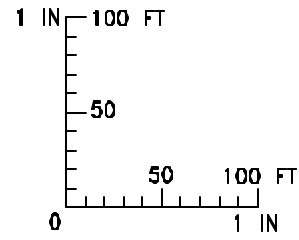

NOTE: WHEN PRINTING THIS DRAWING, MAKE SURE TO ADJUST FOR PROPER SCALING

9.28.2 SCALED DRAWING - 1 IN = 100 FT
MODEL 737-500

D6-58325-6

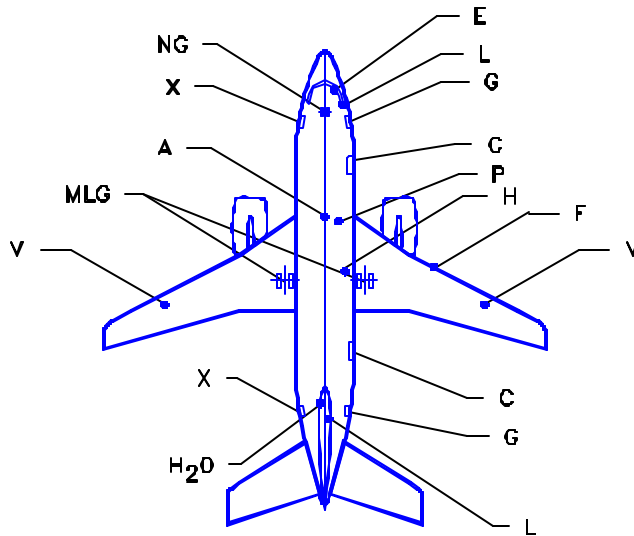
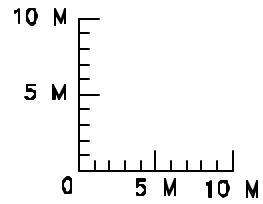

LEGEND

- A AIR CONDITIONING
- C CARGO DOOR
- E ELECTRICAL
- F FUEL
- G SERVICE DOOR
- H HYDRAULIC
- H₂O POTABLE WATER
- L LAVATORY SERVICE
- MLG MAIN LANDING GEAR
- NG NOSE LANDING GEAR
- P PNEUMATIC (AIR START)
- V FUEL VENT
- X PASSENGER DOOR

NOTE: FOR TURNING RADIUS DATA
SEE SECTIONS 4.2 AND 4.3

NOTE: WHEN PRINTING THIS DRAWING, MAKE SURE TO ADJUST FOR PROPER SCALING

9.29.1 SCALED DRAWING – 1:500
MODEL 737-500

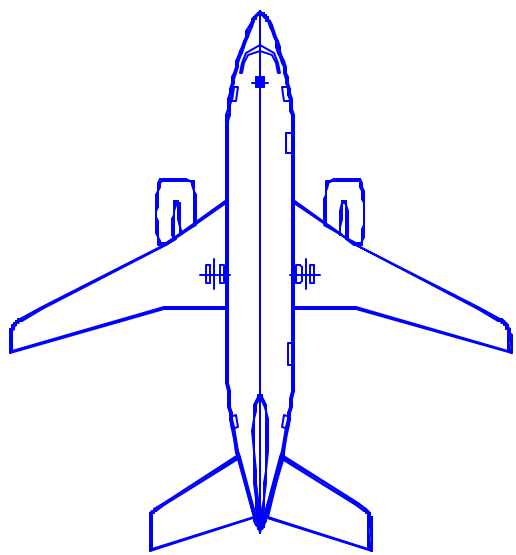
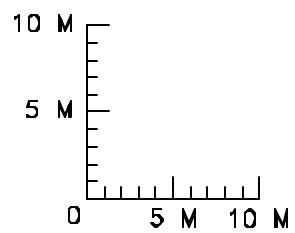

NOTE: WHEN PRINTING THIS DRAWING, MAKE SURE TO ADJUST FOR PROPER SCALING

9.29.2 SCALED DRAWING – 1:500
MODEL 737-500

D6-58325-6

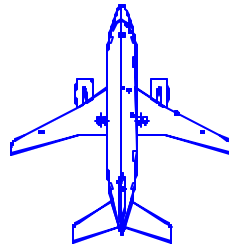
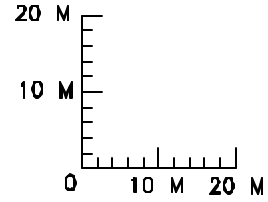

NOTE:

SEE CORRESPONDING PAGE FOR 1 IN = 32 FT
FOR IDENTIFICATIONS OF SERVICE POINTS

LEGEND

A	AIR CONDITIONING
C	CARGO DOOR
E	ELECTRICAL
F	FUEL
G	SERVICE DOOR
H ₂ O	POTABLE WATER
L	LAVATORY SERVICE
MLG	MAIN LANDING GEAR
NG	NOSE LANDING GEAR
O	OXYGEN
P	PNEUMATIC (AIR START)
V	FUEL VENT
X	PASSENGER DOOR

NOTE: FOR TURNING RADIUS DATA
SEE SECTIONS 4.2 AND 4.3

NOTE: WHEN PRINTING THIS DRAWING, MAKE SURE TO ADJUST FOR PROPER SCALING

9.30.1 SCALED DRAWING – 1:1000
MODEL 737-500

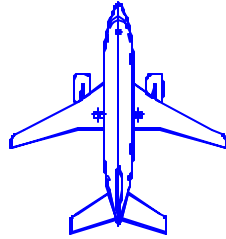
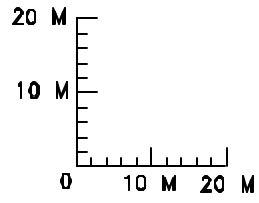

NOTE: WHEN PRINTING THIS DRAWING, MAKE SURE TO ADJUST FOR PROPER SCALING

9.30.2 SCALED DRAWING – 1:1000
MODEL 737-500

D6-58325-6

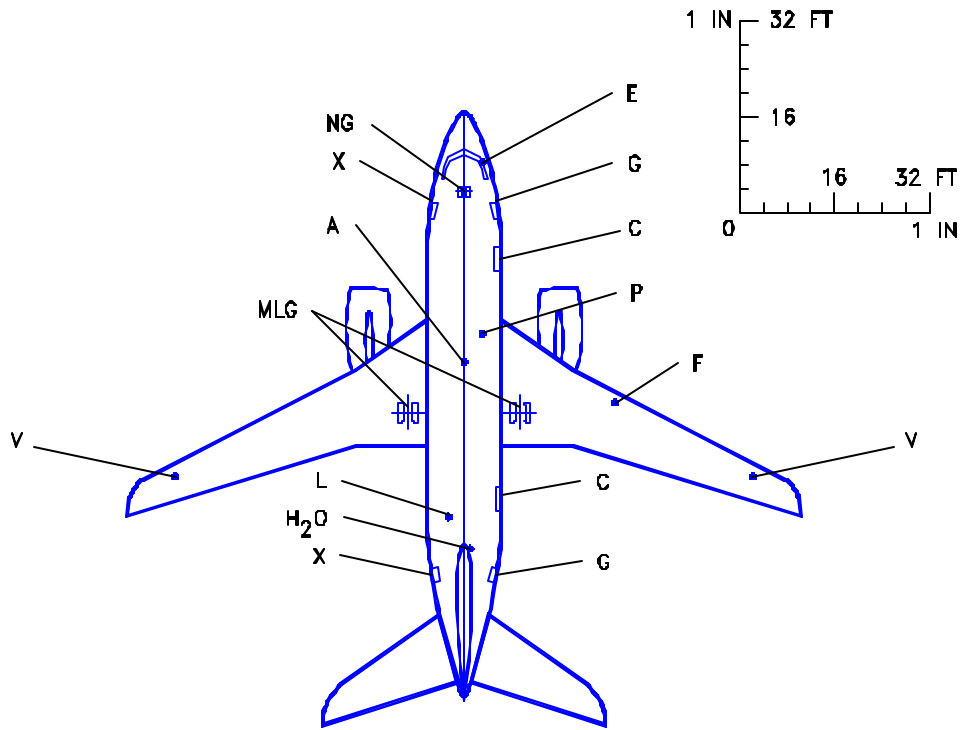

LEGEND

- A AIR CONDITIONING
- C CARGO DOOR
- E ELECTRICAL
- F FUEL
- G SERVICE DOOR
- H₂O POTABLE WATER
- MLG MAIN LANDING GEAR
- NG NOSE LANDING GEAR
- P PNEUMATIC (AIR START)
- L VACUUM LAVATORY SERVICE
- V FUEL VENT
- X PASSENGER DOOR

NOTE: FOR TURNING RADIUS DATA
SEE SECTIONS 4.2 AND 4.3

NOTE: WHEN PRINTING THIS DRAWING, MAKE SURE TO ADJUST FOR PROPER SCALING

9.31.1 SCALED DRAWING - 1 IN = 32 FT
MODEL 737-600

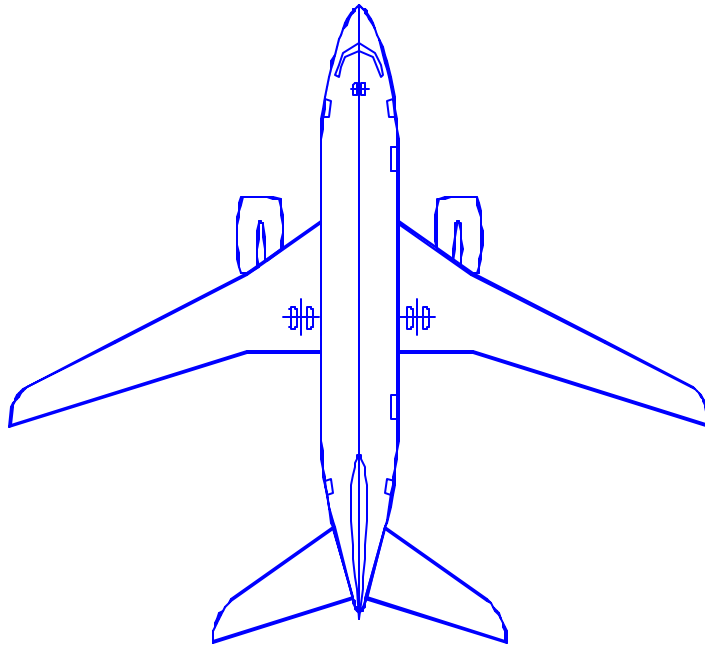
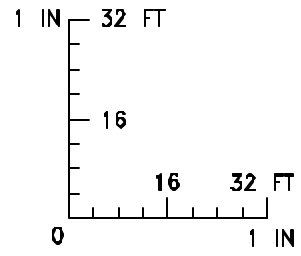

NOTE: WHEN PRINTING THIS DRAWING, MAKE SURE TO ADJUST FOR PROPER SCALING

9.31.2 SCALED DRAWING - 1 IN = 32 FT
MODEL 737-600

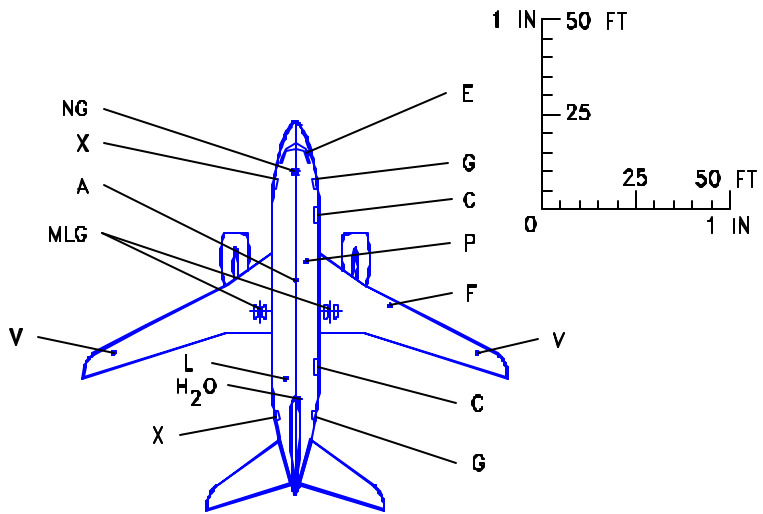

LEGEND

- A AIR CONDITIONING
- C CARGO DOOR
- E ELECTRICAL
- F FUEL
- G SERVICE DOOR
- H₂O POTABLE WATER
- MLG MAIN LANDING GEAR
- NG NOSE LANDING GEAR
- P PNEUMATIC (AIR START)
- L VACUUM LAVATORY SERVICE
- V FUEL VENT
- X PASSENGER DOOR

NOTE: FOR TURNING RADIUS DATA
SEE SECTIONS 4.2 AND 4.3

NOTE: WHEN PRINTING THIS DRAWING, MAKE SURE TO ADJUST FOR PROPER SCALING

9.32.1 SCALED DRAWING - 1 IN = 50 FT
MODEL 737-600

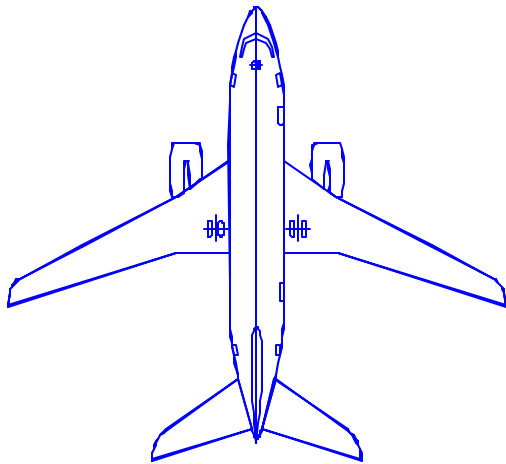
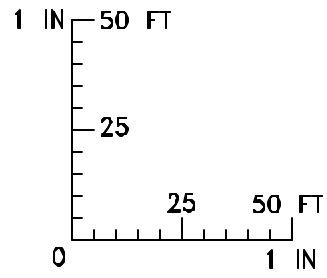

NOTE: WHEN PRINTING THIS DRAWING, MAKE SURE TO ADJUST FOR PROPER SCALING

9.32.2 SCALED DRAWING - 1 IN = 50 FT
MODEL 737-600

D6-58325-6

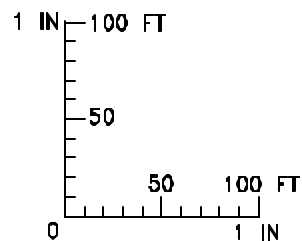
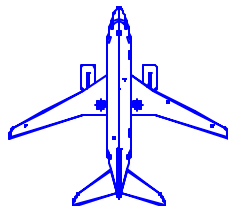

NOTE:

SEE CORRESPONDING PAGE FOR 1 IN = 32 FT
FOR IDENTIFICATIONS OF SERVICE POINTS

LEGEND

- A AIR CONDITIONING
- C CARGO DOOR
- E ELECTRICAL
- F FUEL
- G SERVICE DOOR
- H₂O POTABLE WATER
- MLG MAIN LANDING GEAR
- NG NOSE LANDING GEAR
- P PNEUMATIC (AIR START)
- L VACUUM LAVATORY SERVICE
- V FUEL VENT
- X PASSENGER DOOR

NOTE: FOR TURNING RADIUS DATA
SEE SECTIONS 4.2 AND 4.3

NOTE: WHEN PRINTING THIS DRAWING, MAKE SURE TO ADJUST FOR PROPER SCALING

9.33.1 SCALED DRAWING - 1 IN = 100 FT
MODEL 737-600

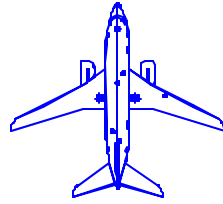
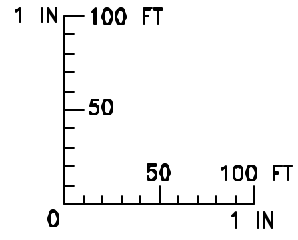

NOTE: WHEN PRINTING THIS DRAWING, MAKE SURE TO ADJUST FOR PROPER SCALING

9.33.2 SCALED DRAWING - 1 IN = 100 FT
MODEL 737-600

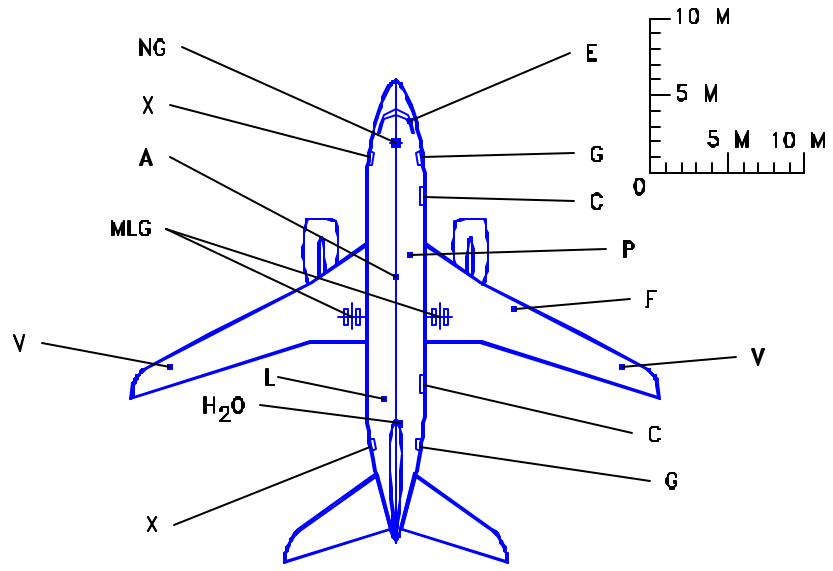

LEGEND

- A AIR CONDITIONING
- C CARGO DOOR
- E ELECTRICAL
- F FUEL
- G SERVICE DOOR
- H₂O POTABLE WATER
- MLG MAIN LANDING GEAR
- NG NOSE LANDING GEAR
- P PNEUMATIC (AIR START)
- L VACUUM LAVATORY SERVICE
- V FUEL VENT
- X PASSENGER DOOR

NOTE: FOR TURNING RADIUS DATA
SEE SECTIONS 4.2 AND 4.3

NOTE: WHEN PRINTING THIS DRAWING, MAKE SURE TO ADJUST FOR PROPER SCALING

9.34.1 SCALED DRAWING - 1:500
MODEL 737-600

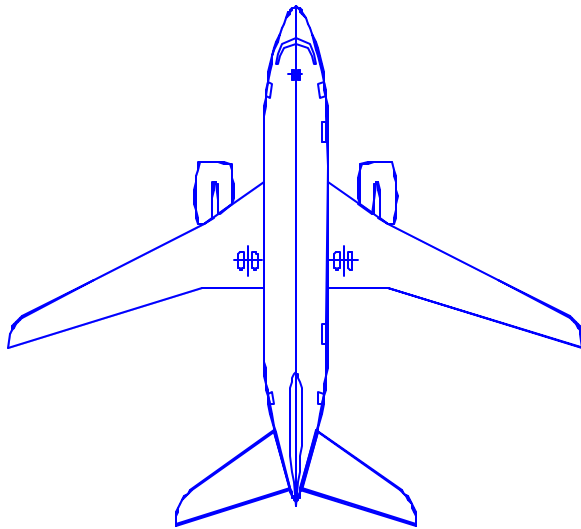
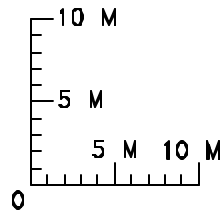

NOTE: WHEN PRINTING THIS DRAWING, MAKE SURE TO ADJUST FOR PROPER SCALING

9.34.2 SCALED DRAWING - 1:500
MODEL 737-600

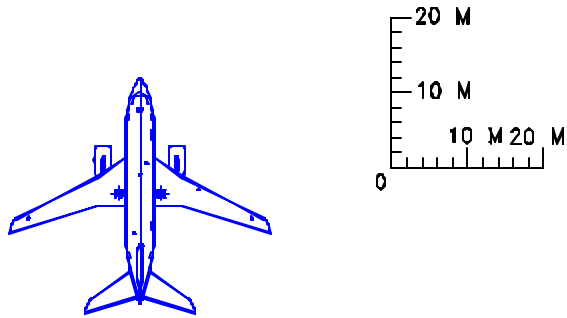

NOTE:

SEE CORRESPONDING PAGE FOR 1 IN = 32 FT
FOR IDENTIFICATIONS OF SERVICE POINTS

LEGEND

A AIR CONDITIONING
 C CARGO DOOR
 E ELECTRICAL
 F FUEL
 G SERVICE DOOR
 H₂O POTABLE WATER
 MLG MAIN LANDING GEAR
 NG NOSE LANDING GEAR
 P PNEUMATIC (AIR START)
 L VACUUM LAVATORY SERVICE
 V FUEL VENT
 X PASSENGER DOOR

NOTE: FOR TURNING RADIUS DATA
SEE SECTIONS 4.2 AND 4.3

NOTE: WHEN PRINTING THIS DRAWING, MAKE SURE TO ADJUST FOR PROPER SCALING

9.35.1 SCALED DRAWING - 1:1000

MODEL 737-600

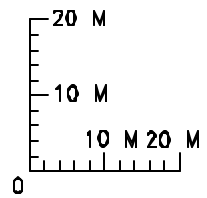
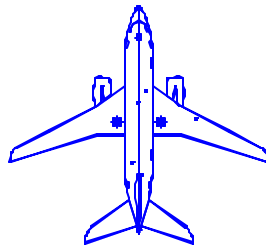

NOTE: WHEN PRINTING THIS DRAWING, MAKE SURE TO ADJUST FOR PROPER SCALING

9.35.2 SCALED DRAWING - 1:1000
MODEL 737-600

D6-58325-6

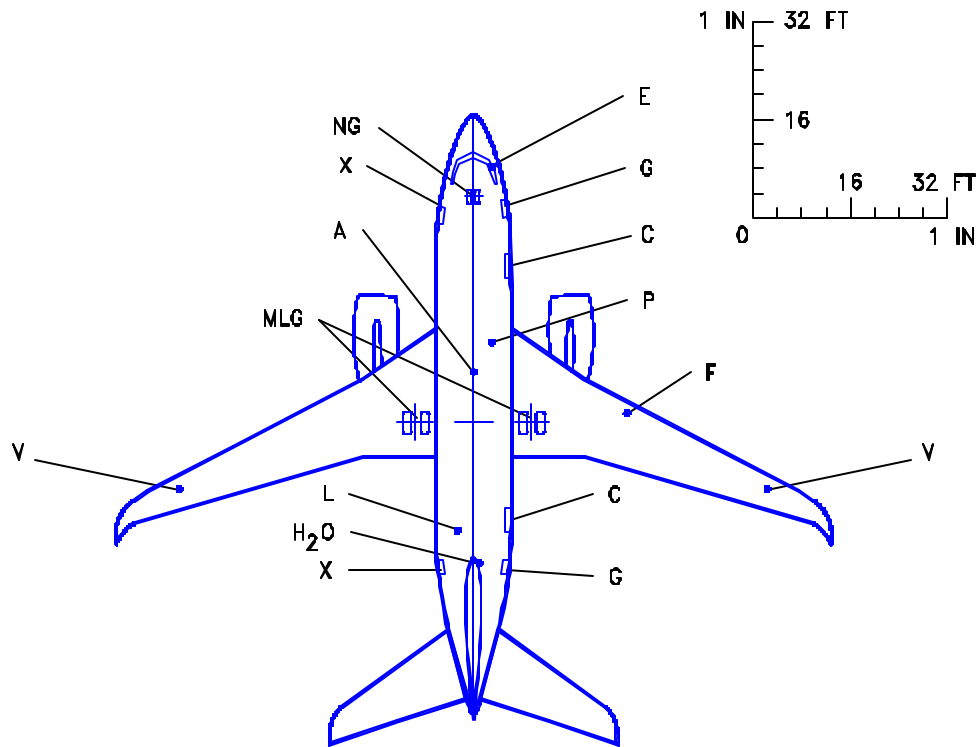

LEGEND

- A AIR CONDITIONING
- C CARGO DOOR
- E ELECTRICAL
- F FUEL
- G SERVICE DOOR
- H₂O POTABLE WATER
- MLG MAIN LANDING GEAR
- NG NOSE LANDING GEAR
- P PNEUMATIC (AIR START)
- L VACUUM LAVATORY SERVICE
- V FUEL VENT
- X PASSENGER DOOR

NOTE: FOR TURNING RADIUS DATA
SEE SECTIONS 4.2 AND 4.3

NOTE: WHEN PRINTING THIS DRAWING, MAKE SURE TO ADJUST FOR PROPER SCALING

9.36.1 SCALED DRAWING - 1 IN = 32 FT
MODEL 737-600 WITH WINGLETS

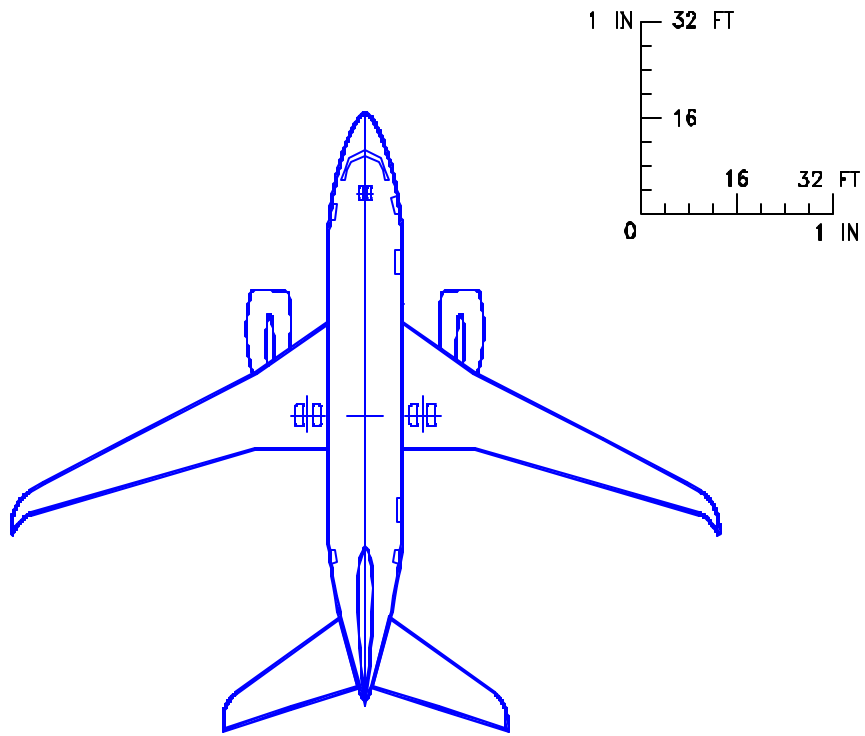

NOTE: WHEN PRINTING THIS DRAWING, MAKE SURE TO ADJUST FOR PROPER SCALING

9.36.2 SCALED DRAWING - 1 IN = 32 FT
MODEL 737-600 WITH WINGLETS

D6-58325-6

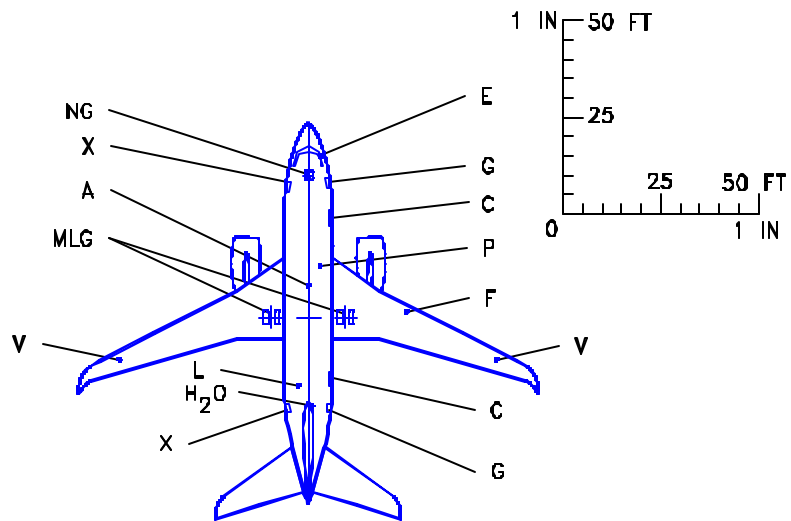

LEGEND

- A AIR CONDITIONING
- C CARGO DOOR
- E ELECTRICAL
- F FUEL
- G SERVICE DOOR
- H₂O POTABLE WATER
- MLG MAIN LANDING GEAR
- NG NOSE LANDING GEAR
- P PNEUMATIC (AIR START)
- L VACUUM LAVATORY SERVICE
- V FUEL VENT
- X PASSENGER DOOR

NOTE: FOR TURNING RADIUS DATA
SEE SECTIONS 4.2 AND 4.3

NOTE: WHEN PRINTING THIS DRAWING, MAKE SURE TO ADJUST FOR PROPER SCALING

9.37.1 SCALED DRAWING - 1 IN = 50 FT

MODEL 737-600 WITH WINGLETS

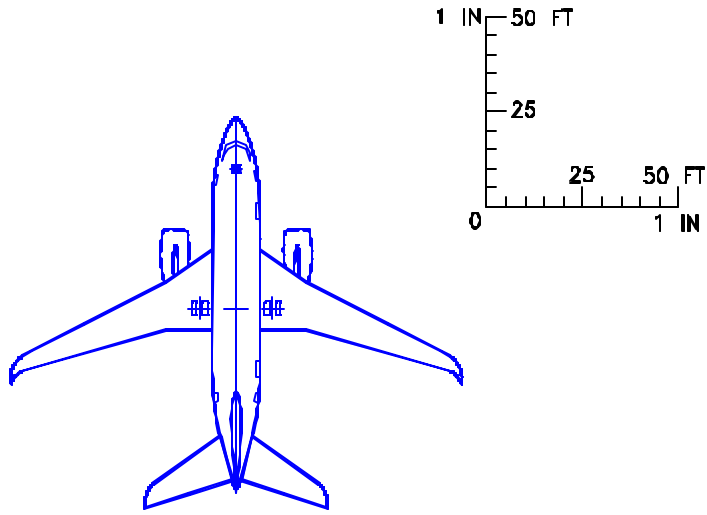

NOTE: WHEN PRINTING THIS DRAWING, MAKE SURE TO ADJUST FOR PROPER SCALING

9.37.2 SCALED DRAWING - 1 IN = 50 FT
MODEL 737-600 WITH WINGLETS

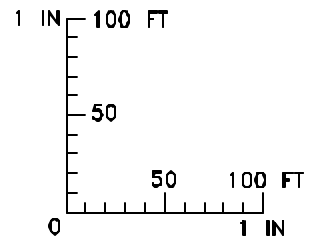
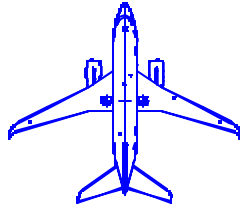

NOTE:

SEE CORRESPONDING PAGE FOR 1 IN = 32 FT
FOR IDENTIFICATIONS OF SERVICE POINTS

LEGEND

A AIR CONDITIONING
C CARGO DOOR
E ELECTRICAL
F FUEL
G SERVICE DOOR
H₂O POTABLE WATER
MLG MAIN LANDING GEAR
NG NOSE LANDING GEAR
P PNEUMATIC (AIR START)
L VACUUM LAVATORY SERVICE
V FUEL VENT
X PASSENGER DOOR

NOTE: FOR TURNING RADIUS DATA
SEE SECTIONS 4.2 AND 4.3

NOTE: WHEN PRINTING THIS DRAWING, MAKE SURE TO ADJUST FOR PROPER SCALING

9.38.1 SCALED DRAWING - 1 IN = 100 FT
MODEL 737-600 WITH WINGLETS

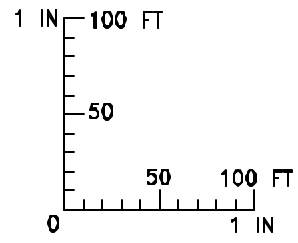
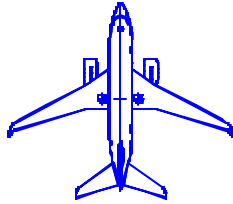

NOTE: WHEN PRINTING THIS DRAWING, MAKE SURE TO ADJUST FOR PROPER SCALING

9.38.2 SCALED DRAWING - 1 IN = 100 FT
MODEL 737-600 WITH WINGLETS

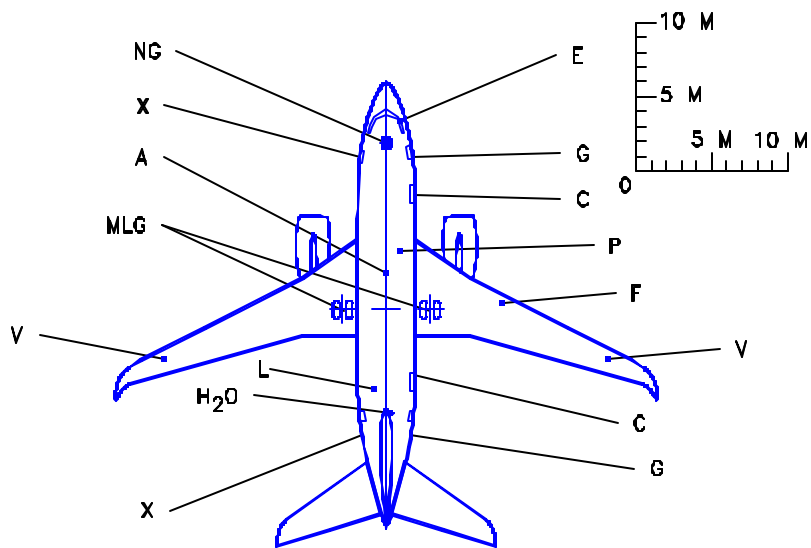

LEGEND

- A AIR CONDITIONING
- C CARGO DOOR
- E ELECTRICAL
- F FUEL
- G SERVICE DOOR
- H₂O POTABLE WATER
- MLG MAIN LANDING GEAR
- NG NOSE LANDING GEAR
- P PNEUMATIC (AIR START)
- L VACUUM LAVATORY SERVICE
- V FUEL VENT
- X PASSENGER DOOR

NOTE: FOR TURNING RADIUS DATA
SEE SECTIONS 4.2 AND 4.3

NOTE: WHEN PRINTING THIS DRAWING, MAKE SURE TO ADJUST FOR PROPER SCALING

9.39.1 SCALED DRAWING - 1:500
MODEL 737-600 WITH WINGLETS

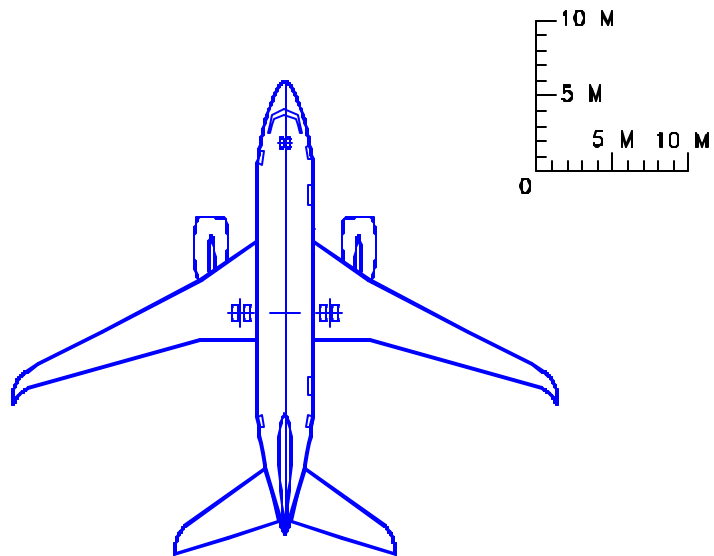

NOTE: WHEN PRINTING THIS DRAWING, MAKE SURE TO ADJUST FOR PROPER SCALING

9.39.2 SCALED DRAWING - 1:500
MODEL 737-600 WITH WINGLETS

D6-58325-6

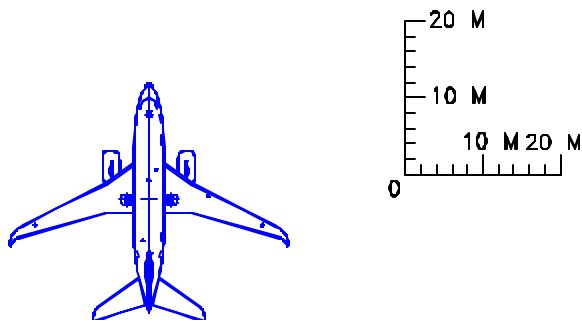

NOTE:

SEE CORRESPONDING PAGE FOR 1 IN = 32 FT
FOR IDENTIFICATIONS OF SERVICE POINTS

LEGEND

A	AIR CONDITIONING
C	CARGO DOOR
E	ELECTRICAL
F	FUEL
G	SERVICE DOOR
H ₂ O	POTABLE WATER
MLG	MAIN LANDING GEAR
NG	NOSE LANDING GEAR
P	PNEUMATIC (AIR START)
L	VACUUM LAVATORY SERVICE
V	FUEL VENT
X	PASSENGER DOOR

NOTE: FOR TURNING RADIUS DATA
SEE SECTIONS 4.2 AND 4.3

NOTE: WHEN PRINTING THIS DRAWING, MAKE SURE TO ADJUST FOR PROPER SCALING

9.40.1 SCALED DRAWING - 1:1000
MODEL 737-600 WITH WINGLETS

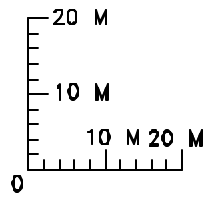
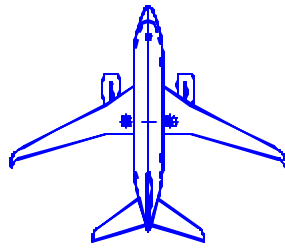

NOTE: WHEN PRINTING THIS DRAWING, MAKE SURE TO ADJUST FOR PROPER SCALING

9.40.2 SCALED DRAWING - 1:1000
MODEL 737-600 WITH WINGLETS

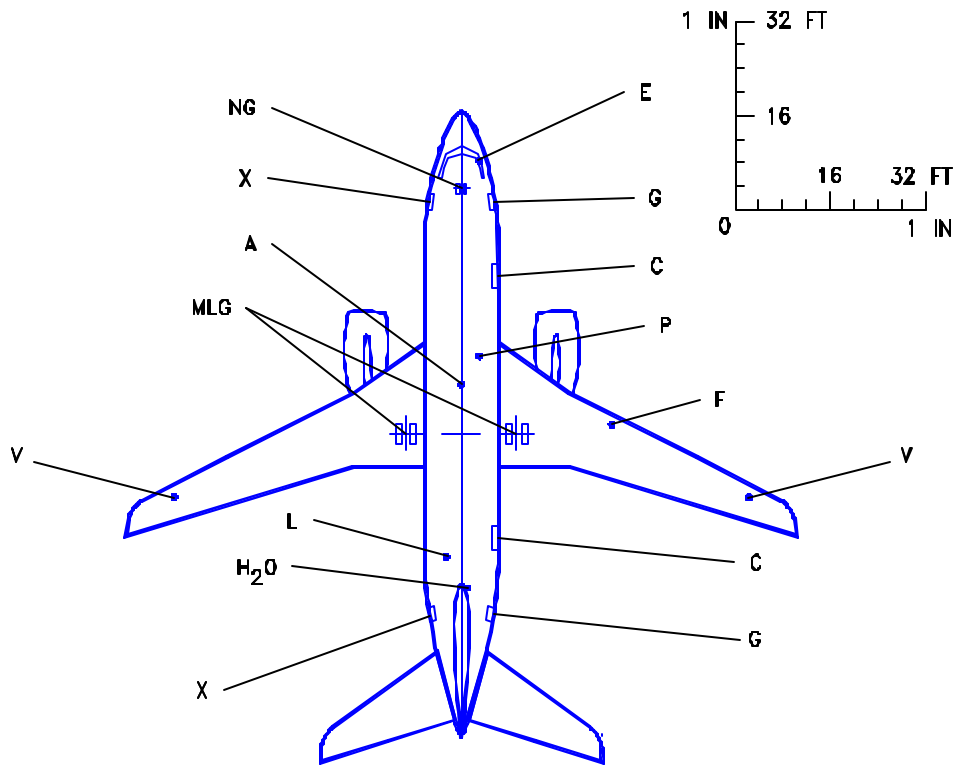

LEGEND

- A AIR CONDITIONING
- C CARGO DOOR
- E ELECTRICAL
- F FUEL
- G SERVICE DOOR
- H₂O POTABLE WATER
- MLG MAIN LANDING GEAR
- NG NOSE LANDING GEAR
- P PNEUMATIC (AIR START)
- L VACUUM LAVATORY SERVICE
- V FUEL VENT
- X PASSENGER DOOR

NOTE: FOR TURNING RADIUS DATA
SEE SECTIONS 4.2 AND 4.3

NOTE: WHEN PRINTING THIS DRAWING, MAKE SURE TO ADJUST FOR PROPER SCALING

9.41.1 SCALED DRAWING - 1 IN = 32 FT
MODEL 737-700

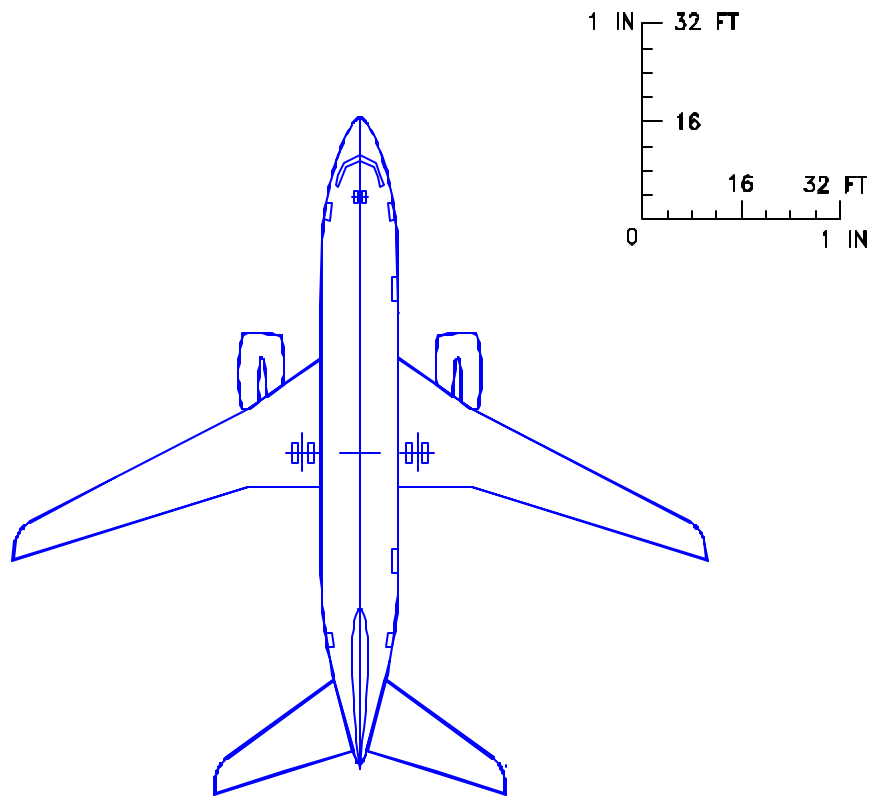

NOTE: WHEN PRINTING THIS DRAWING, MAKE SURE TO ADJUST FOR PROPER SCALING

9.41.2 SCALED DRAWING - 1 IN = 32 FT
MODEL 737-700

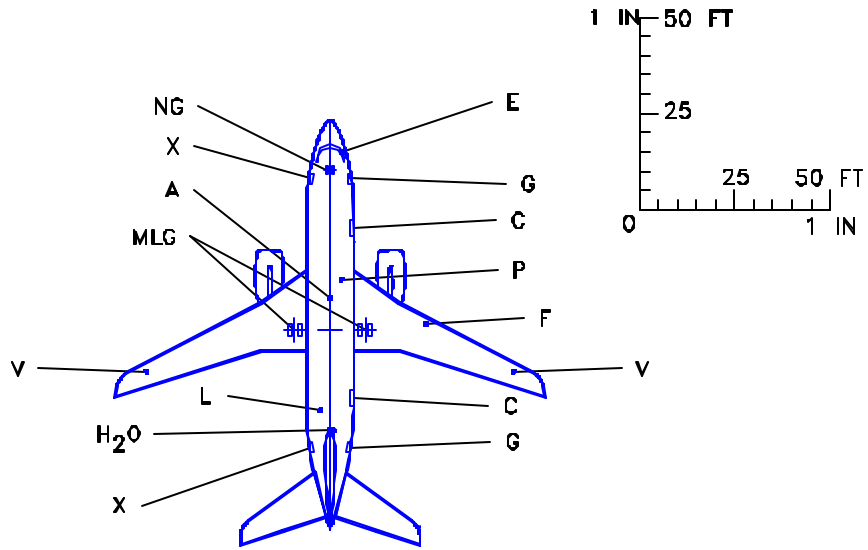

LEGEND

- A AIR CONDITIONING
- C CARGO DOOR
- E ELECTRICAL
- F FUEL
- G SERVICE DOOR
- H₂O POTABLE WATER
- MLG MAIN LANDING GEAR
- NG NOSE LANDING GEAR
- P PNEUMATIC (AIR START)
- L VACUUM LAVATORY SERVICE
- V FUEL VENT
- X PASSENGER DOOR

NOTE: FOR TURNING RADIUS DATA
SEE SECTIONS 4.2 AND 4.3

NOTE: WHEN PRINTING THIS DRAWING, MAKE SURE TO ADJUST FOR PROPER SCALING

9.42.1 SCALED DRAWING - 1 IN = 50 FT
MODEL 737-700

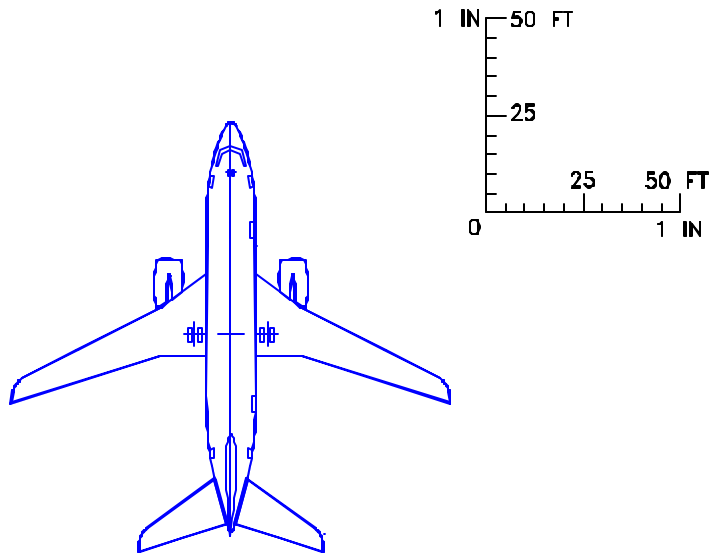

NOTE: WHEN PRINTING THIS DRAWING, MAKE SURE TO ADJUST FOR PROPER SCALING

9.42.2 SCALED DRAWING - 1 IN = 50 FT
MODEL 737-700

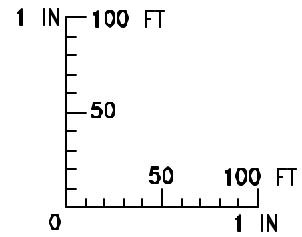
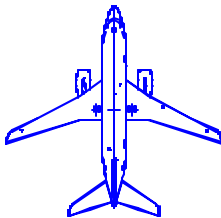

NOTE:

SEE CORRESPONDING PAGE FOR 1 IN = 32 FT
FOR IDENTIFICATIONS OF SERVICE POINTS

LEGEND

A AIR CONDITIONING
C CARGO DOOR
E ELECTRICAL
F FUEL
G SERVICE DOOR
H₂O POTABLE WATER
MLG MAIN LANDING GEAR
NG NOSE LANDING GEAR
P PNEUMATIC (AIR START)
L VACUUM LAVATORY SERVICE
V FUEL VENT
X PASSENGER DOOR

NOTE: FOR TURNING RADIUS DATA
SEE SECTIONS 4.2 AND 4.3

NOTE: WHEN PRINTING THIS DRAWING, MAKE SURE TO ADJUST FOR PROPER SCALING

9.43.1 SCALED DRAWING - 1 IN = 100 FT
MODEL 737-700

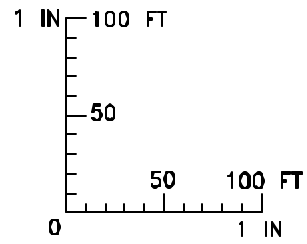
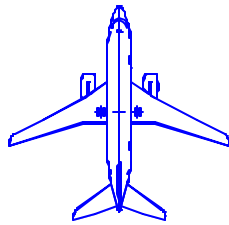

NOTE: WHEN PRINTING THIS DRAWING, MAKE SURE TO ADJUST FOR PROPER SCALING

9.43.2 SCALED DRAWING - 1 IN = 100 FT
MODEL 737-700

D6-58325-6

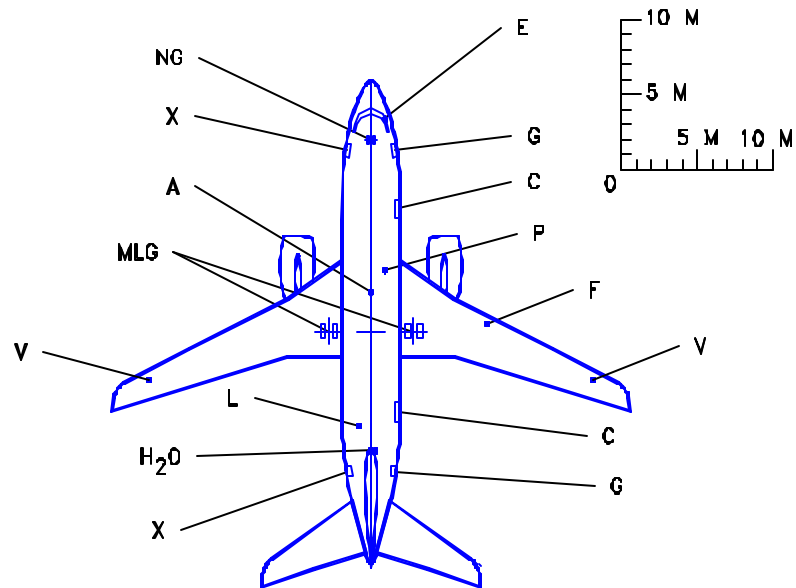

LEGEND

- A AIR CONDITIONING
- C CARGO DOOR
- E ELECTRICAL
- F FUEL
- G SERVICE DOOR
- H₂O POTABLE WATER
- MLG MAIN LANDING GEAR
- NG NOSE LANDING GEAR
- P PNEUMATIC (AIR START)
- L VACUUM LAVATORY SERVICE
- V FUEL VENT
- X PASSENGER DOOR

NOTE: FOR TURNING RADIUS DATA
SEE SECTIONS 4.2 AND 4.3

NOTE: WHEN PRINTING THIS DRAWING, MAKE SURE TO ADJUST FOR PROPER SCALING

9.44.1 SCALED DRAWING - 1:500
MODEL 737-700

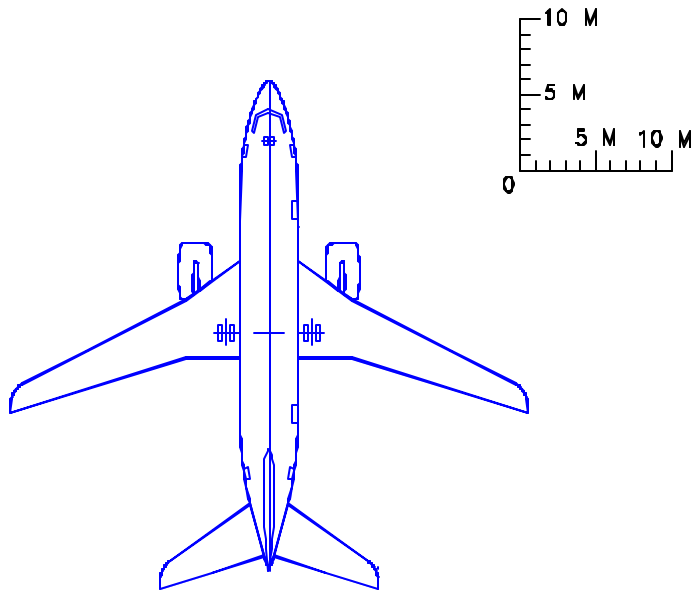

NOTE: WHEN PRINTING THIS DRAWING, MAKE SURE TO ADJUST FOR PROPER SCALING

9.44.2 SCALED DRAWING - 1:500
MODEL 737-700

D6-58325-6

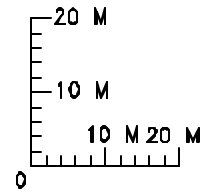
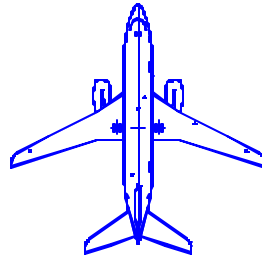

NOTE:

SEE CORRESPONDING PAGE FOR 1 IN = 32 FT
FOR IDENTIFICATIONS OF SERVICE POINTS

LEGEND

- A AIR CONDITIONING
- C CARGO DOOR
- E ELECTRICAL
- F FUEL
- G SERVICE DOOR
- H₂O POTABLE WATER
- MLG MAIN LANDING GEAR
- NG NOSE LANDING GEAR
- P PNEUMATIC (AIR START)
- L VACUUM LAVATORY SERVICE
- V FUEL VENT
- X PASSENGER DOOR

NOTE: FOR TURNING RADIUS DATA
SEE SECTIONS 4.2 AND 4.3

NOTE: WHEN PRINTING THIS DRAWING, MAKE SURE TO ADJUST FOR PROPER SCALING

9.45.1 SCALED DRAWING - 1:1000
MODEL 737-700

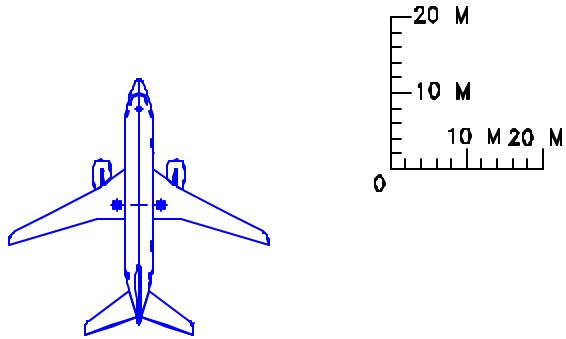

NOTE: WHEN PRINTING THIS DRAWING, MAKE SURE TO ADJUST FOR PROPER SCALING

9.45.2 SCALED DRAWING - 1:1000
MODEL 737-700

D6-58325-6

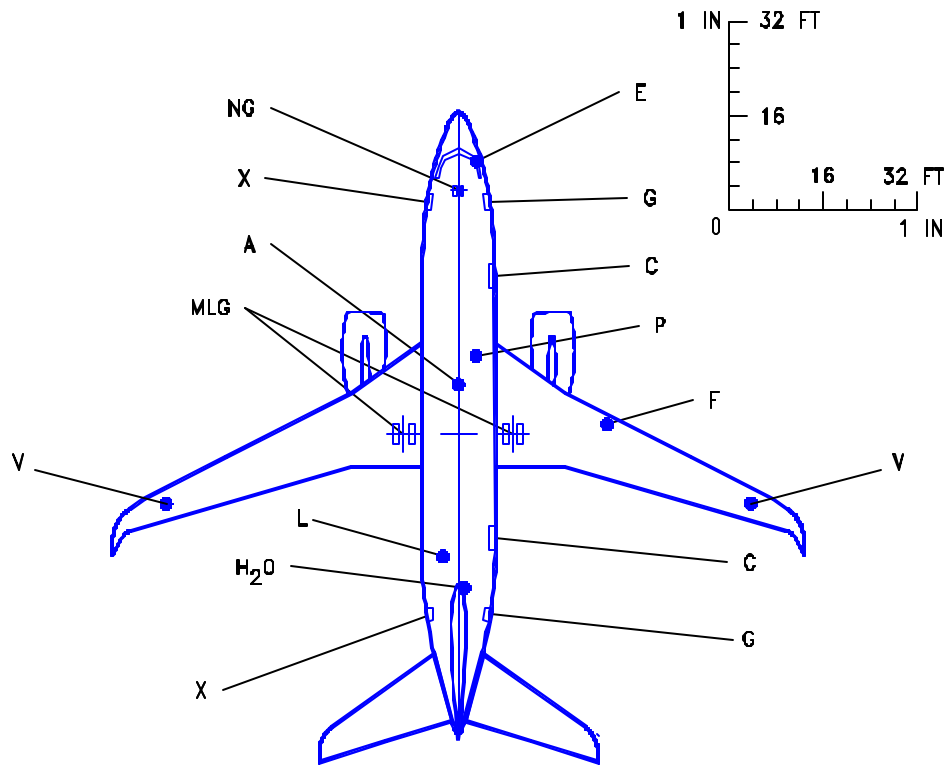

LEGEND

- A AIR CONDITIONING
- C CARGO DOOR
- E ELECTRICAL
- F FUEL
- G SERVICE DOOR
- H₂O POTABLE WATER
- MLG MAIN LANDING GEAR
- NG NOSE LANDING GEAR
- P PNEUMATIC (AIR START)
- L VACUUM LAVATORY SERVICE
- V FUEL VENT
- X PASSENGER DOOR

NOTE: FOR TURNING RADIUS DATA
SEE SECTIONS 4.2 AND 4.3

NOTE: WHEN PRINTING THIS DRAWING, MAKE SURE TO ADJUST FOR PROPER SCALING

9.46.1 SCALED DRAWING - 1 IN = 32 FT
MODEL 737-700 WITH WINGLETS, 737 BBJ

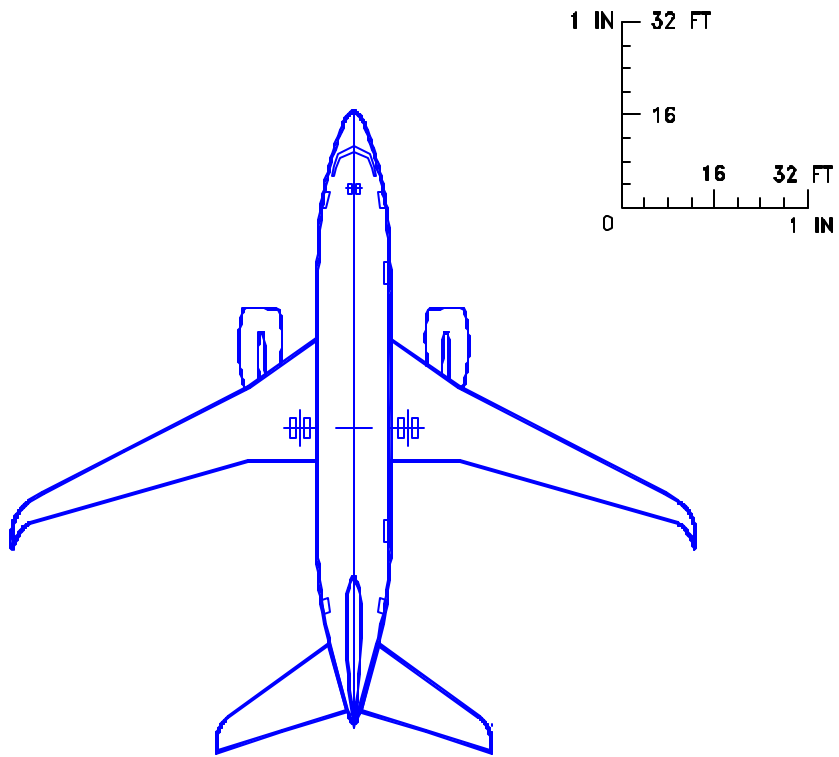

NOTE: WHEN PRINTING THIS DRAWING, MAKE SURE TO ADJUST FOR PROPER SCALING

9.46.2 SCALED DRAWING - 1 IN = 32 FT
MODEL 737-700 WITH WINGLETS, 737 BBJ

D6-58325-6

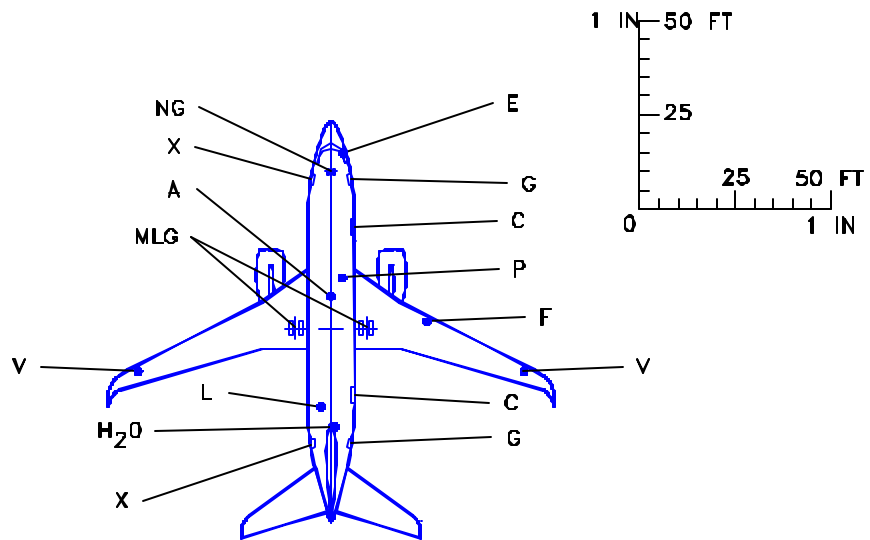

LEGEND

- A AIR CONDITIONING
 - C CARGO DOOR
 - E ELECTRICAL
 - F FUEL
 - G SERVICE DOOR
 - H₂O POTABLE WATER
 - MLG MAIN LANDING GEAR
 - NG NOSE LANDING GEAR
 - P PNEUMATIC (AIR START)
 - L VACUUM LAVATORY SERVICE
 - V FUEL VENT
 - X PASSENGER DOOR
- NOTE: FOR TURNING RADIUS DATA
SEE SECTIONS 4.2 AND 4.3

NOTE: WHEN PRINTING THIS DRAWING, MAKE SURE TO ADJUST FOR PROPER SCALING

9.47.1 SCALED DRAWING - 1 IN = 50 FT
MODEL 737-700 WITH WINGLETS, 737 BBJ

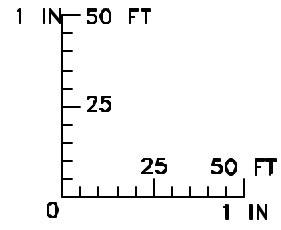
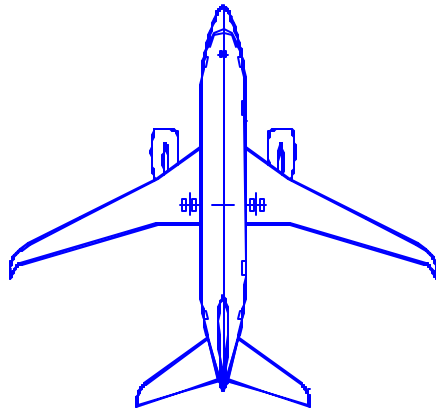

NOTE: WHEN PRINTING THIS DRAWING, MAKE SURE TO ADJUST FOR PROPER SCALING

9.47.2 SCALED DRAWING - 1 IN = 50 FT
MODEL 737-700 WITH WINGLETS, 737 BBJ

D6-58325-6

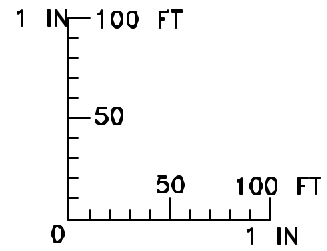
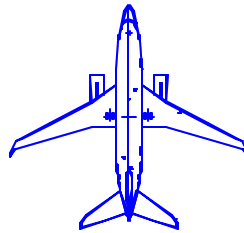

NOTE:

SEE CORRESPONDING PAGE FOR 1 IN = 32 FT
FOR IDENTIFICATIONS OF SERVICE POINTS

LEGEND

A AIR CONDITIONING
C CARGO DOOR
E ELECTRICAL
F FUEL
G SERVICE DOOR
H₂O POTABLE WATER
MLG MAIN LANDING GEAR
NG NOSE LANDING GEAR
P PNEUMATIC (AIR START)
L VACUUM LAVATORY SERVICE
V FUEL VENT
X PASSENGER DOOR

NOTE: FOR TURNING RADIUS DATA
SEE SECTIONS 4.2 AND 4.3

NOTE: WHEN PRINTING THIS DRAWING, MAKE SURE TO ADJUST FOR PROPER SCALING

9.48.1 SCALED DRAWING - 1 IN = 100 FT
MODEL 737-700 WITH WINGLETS, 737 BBJ

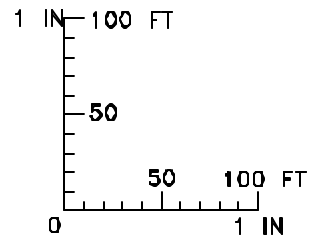
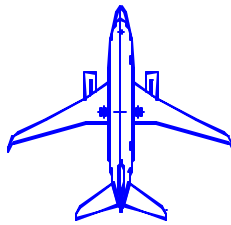

NOTE: WHEN PRINTING THIS DRAWING, MAKE SURE TO ADJUST FOR PROPER SCALING

9.48.2 SCALED DRAWING - 1 IN = 100 FT
MODEL 737-700 WITH WINGLETS, 737 BBJ

D6-58325-6

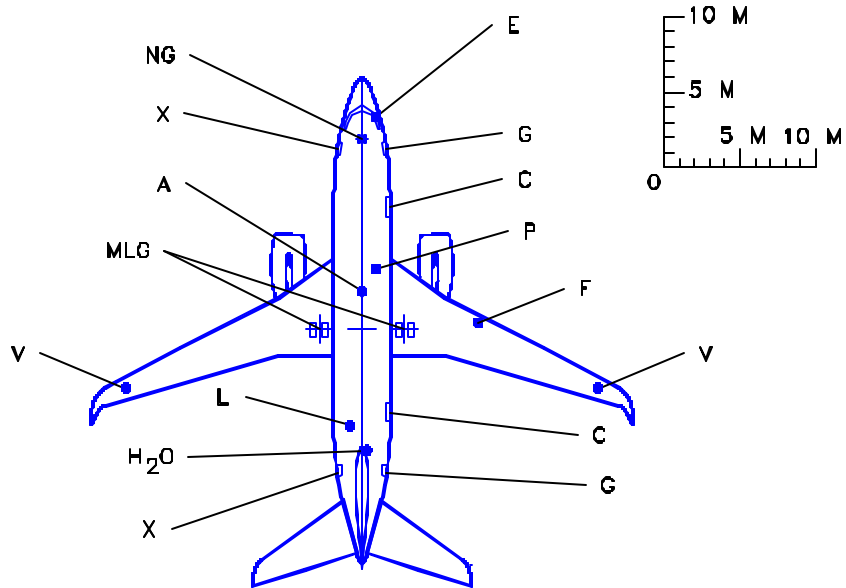

LEGEND

- A AIR CONDITIONING
- C CARGO DOOR
- E ELECTRICAL
- F FUEL
- G SERVICE DOOR
- H₂O POTABLE WATER
- MLG MAIN LANDING GEAR
- NG NOSE LANDING GEAR
- P PNEUMATIC (AIR START)
- L VACUUM LAVATORY SERVICE
- V FUEL VENT
- X PASSENGER DOOR

NOTE: FOR TURNING RADIUS DATA
SEE SECTIONS 4.2 AND 4.3

NOTE: WHEN PRINTING THIS DRAWING, MAKE SURE TO ADJUST FOR PROPER SCALING

9.49.1 SCALED DRAWING - 1:500
MODEL 737-700 WITH WINGLETS, 737 BBJ

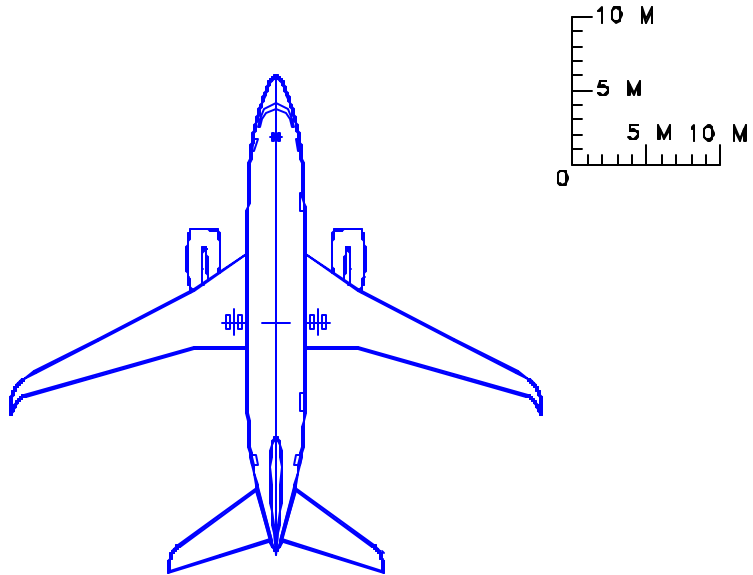

NOTE: WHEN PRINTING THIS DRAWING, MAKE SURE TO ADJUST FOR PROPER SCALING

9.49.2 SCALED DRAWING - 1:500
MODEL 737-700 WITH WINGLETS, 737 BBJ

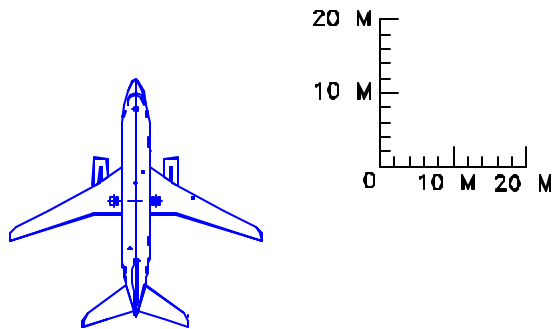

NOTE:

SEE CORRESPONDING PAGE FOR 1 IN = 32 FT
FOR IDENTIFICATIONS OF SERVICE POINTS

LEGEND

- A AIR CONDITIONING
- C CARGO DOOR
- E ELECTRICAL
- F FUEL
- G SERVICE DOOR
- H₂O POTABLE WATER
- MLG MAIN LANDING GEAR
- NG NOSE LANDING GEAR
- P PNEUMATIC (AIR START)
- L VACUUM LAVATORY SERVICE
- V FUEL VENT
- X PASSENGER DOOR

NOTE: FOR TURNING RADIUS DATA
SEE SECTIONS 4.2 AND 4.3

NOTE: WHEN PRINTING THIS DRAWING, MAKE SURE TO ADJUST FOR PROPER SCALING

9.50.1 SCALED DRAWING - 1:1000
MODEL 737-700 WITH WINGLETS, 737 BBJ

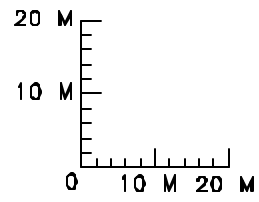
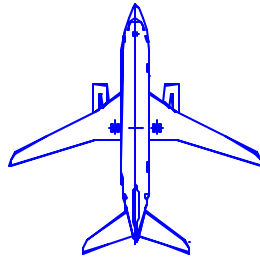

NOTE: WHEN PRINTING THIS DRAWING, MAKE SURE TO ADJUST FOR PROPER SCALING

9.50.2 SCALED DRAWING - 1:1000
MODEL 737-700 WITH WINGLETS, 737 BBJ

D6-58325-6

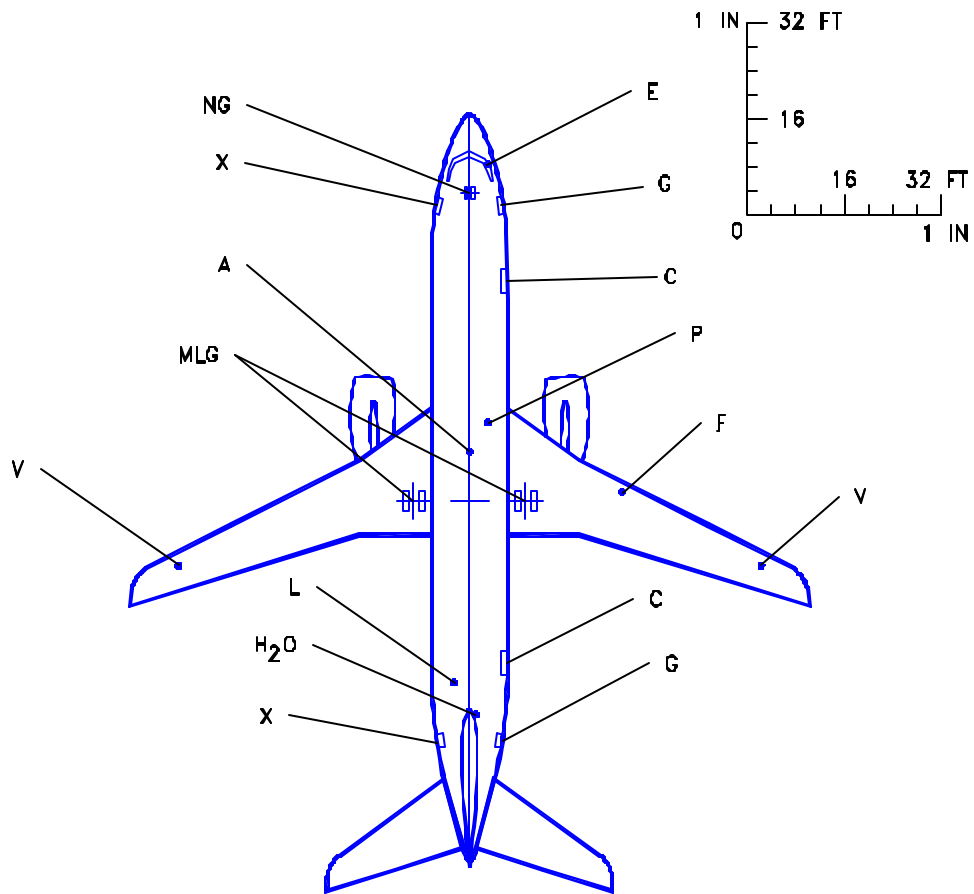

LEGEND

- A AIR CONDITIONING
- C CARGO DOOR
- E ELECTRICAL
- F FUEL
- G SERVICE DOOR
- H₂O POTABLE WATER
- MLG MAIN LANDING GEAR
- NG NOSE LANDING GEAR
- P PNEUMATIC (AIR START)
- L VACUUM LAVATORY SERVICE
- V FUEL VENT
- X PASSENGER DOOR

NOTE: FOR TURNING RADIUS DATA
SEE SECTIONS 4.2 AND 4.3

NOTE: WHEN PRINTING THIS DRAWING, MAKE SURE TO ADJUST FOR PROPER SCALING

9.51.1 SCALED DRAWING - 1 IN = 32 FT
MODEL 737-800

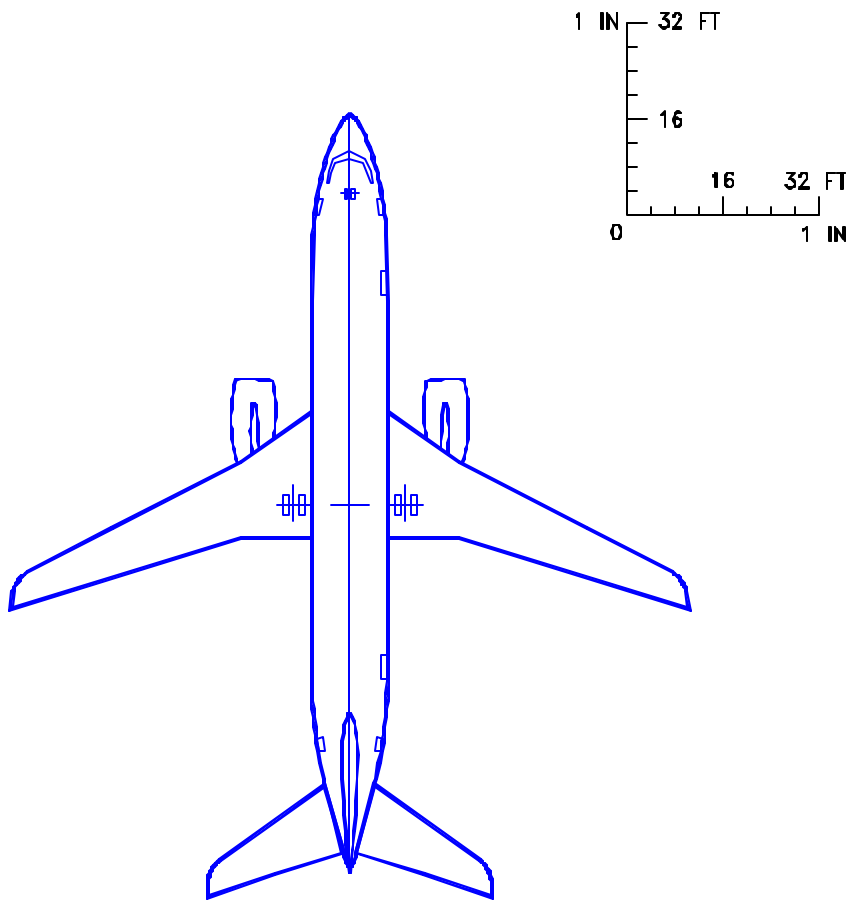

NOTE: WHEN PRINTING THIS DRAWING, MAKE SURE TO ADJUST FOR PROPER SCALING

9.51.2 SCALED DRAWING - 1 IN = 32 FT
MODEL 737-800

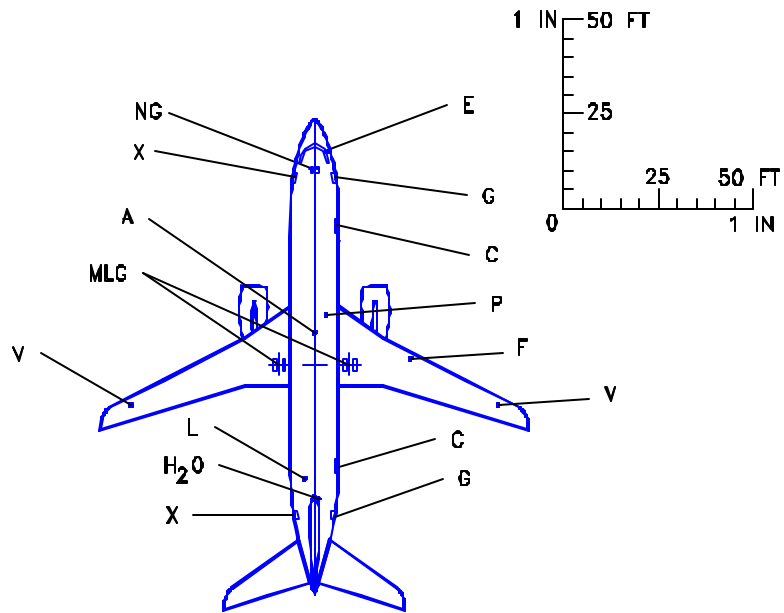

LEGEND

- A AIR CONDITIONING
- C CARGO DOOR
- E ELECTRICAL
- F FUEL
- G SERVICE DOOR
- H₂O POTABLE WATER
- MLG MAIN LANDING GEAR
- NG NOSE LANDING GEAR
- P PNEUMATIC (AIR START)
- L VACUUM LAVATORY SERVICE
- V FUEL VENT
- X PASSENGER DOOR

NOTE: FOR TURNING RADIUS DATA
SEE SECTIONS 4.2 AND 4.3

NOTE: WHEN PRINTING THIS DRAWING, MAKE SURE TO ADJUST FOR PROPER SCALING

9.52.1 SCALED DRAWING - 1 IN = 50 FT
MODEL 737-800

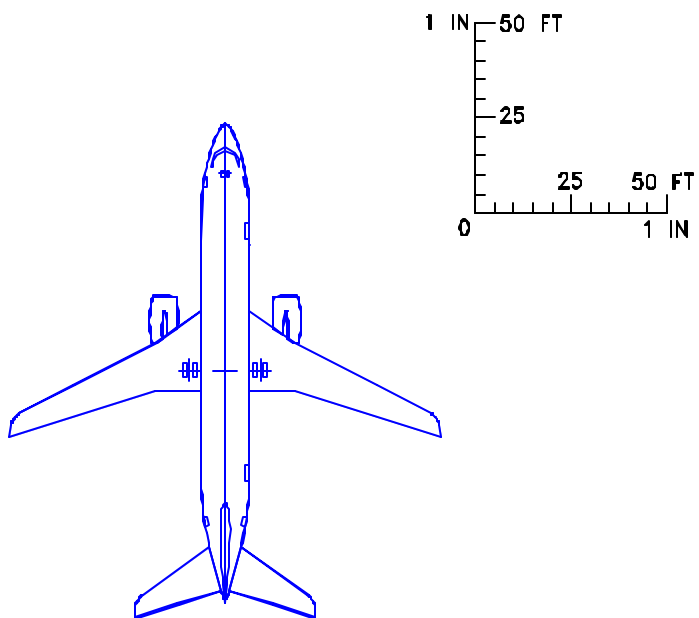

NOTE: WHEN PRINTING THIS DRAWING, MAKE SURE TO ADJUST FOR PROPER SCALING

9.52.2 SCALED DRAWING - 1 IN = 50 FT
MODEL 737-800

D6-58325-6

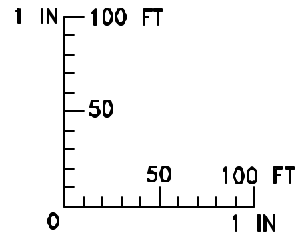
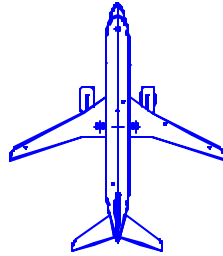

NOTE:

SEE CORRESPONDING PAGE FOR 1 IN = 32 FT
FOR IDENTIFICATIONS OF SERVICE POINTS

LEGEND

A	AIR CONDITIONING
C	CARGO DOOR
E	ELECTRICAL
F	FUEL
G	SERVICE DOOR
H ₂ O	POTABLE WATER
MLG	MAIN LANDING GEAR
NG	NOSE LANDING GEAR
P	PNEUMATIC (AIR START)
L	VACUUM LAVATORY SERVICE
V	FUEL VENT
X	PASSENGER DOOR

NOTE: FOR TURNING RADIUS DATA
SEE SECTIONS 4.2 AND 4.3

NOTE: WHEN PRINTING THIS DRAWING, MAKE SURE TO ADJUST FOR PROPER SCALING

9.53.1 SCALED DRAWING - 1 IN = 100 FT *MODEL 737-800*

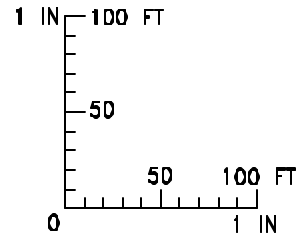
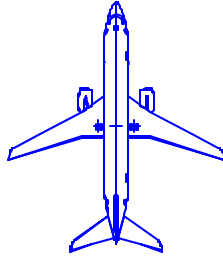

NOTE: WHEN PRINTING THIS DRAWING, MAKE SURE TO ADJUST FOR PROPER SCALING

9.53.2 SCALED DRAWING - 1 IN = 100 FT
MODEL 737-800

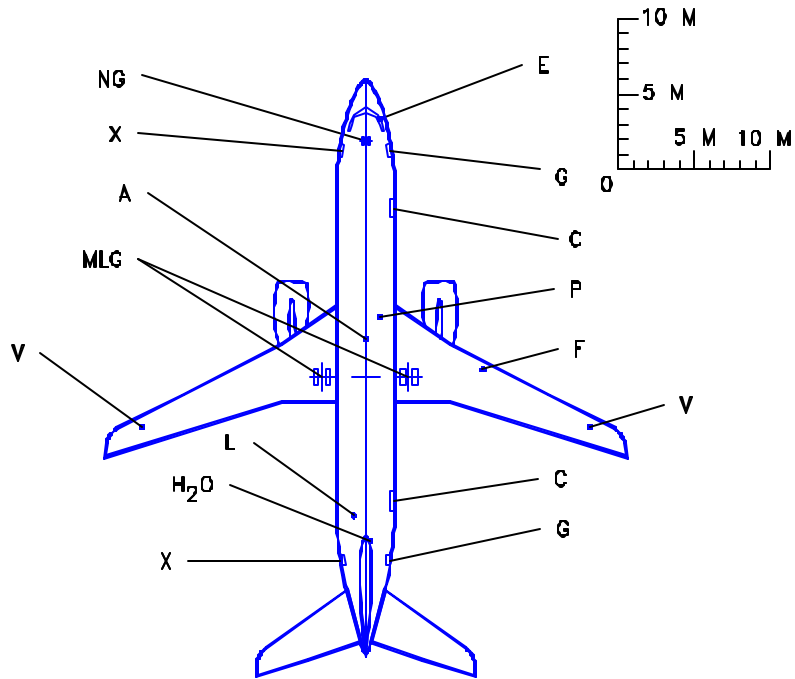

LEGEND

- A AIR CONDITIONING
- C CARGO DOOR
- E ELECTRICAL
- F FUEL
- G SERVICE DOOR
- H₂O POTABLE WATER
- MLG MAIN LANDING GEAR
- NG NOSE LANDING GEAR
- P PNEUMATIC (AIR START)
- L VACUUM LAVATORY SERVICE
- V FUEL VENT
- X PASSENGER DOOR

NOTE: FOR TURNING RADIUS DATA
SEE SECTIONS 4.2 AND 4.3

NOTE: WHEN PRINTING THIS DRAWING, MAKE SURE TO ADJUST FOR PROPER SCALING

9.54.1 SCALED DRAWING - 1:500
MODEL 737-800

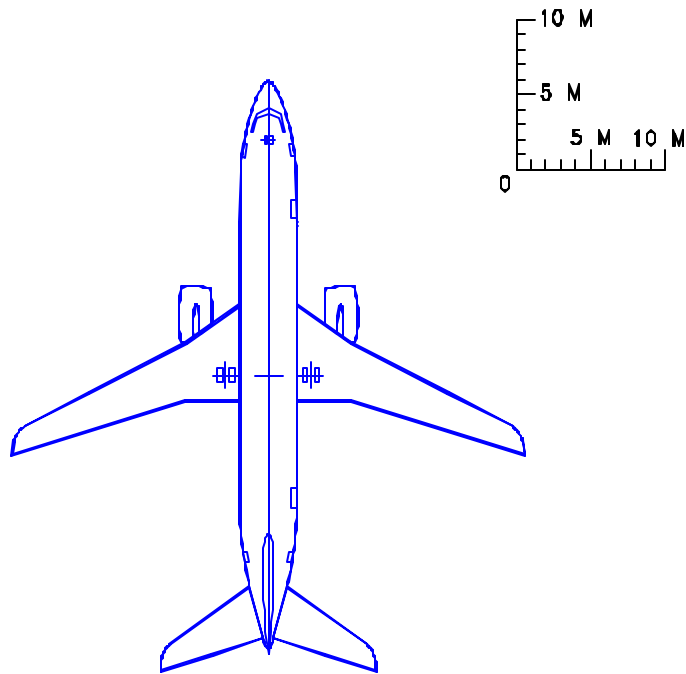

NOTE: WHEN PRINTING THIS DRAWING, MAKE SURE TO ADJUST FOR PROPER SCALING

9.54.2 SCALED DRAWING - 1:500
MODEL 737-800

D6-58325-6

650 OCTOBER 2005

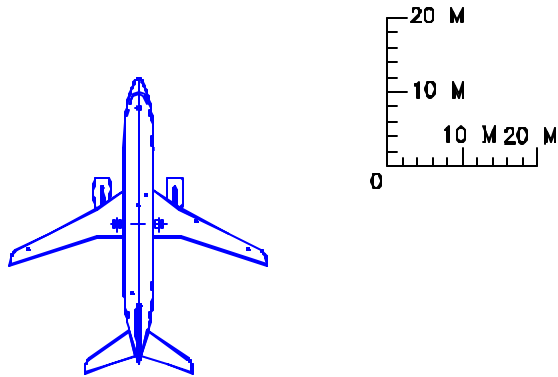

NOTE:

**SEE CORRESPONDING PAGE FOR 1 IN = 32 FT
FOR IDENTIFICATIONS OF SERVICE POINTS**

LEGEND

A	AIR CONDITIONING
C	CARGO DOOR
E	ELECTRICAL
F	FUEL
G	SERVICE DOOR
H₂O	POTABLE WATER
MLG	MAIN LANDING GEAR
NG	NOSE LANDING GEAR
P	PNEUMATIC (AIR START)
L	VACUUM LAVATORY SERVICE
V	FUEL VENT
X	PASSENGER DOOR

NOTE: FOR TURNING RADIUS DATA
SEE SECTIONS 4.2 AND 4.3

NOTE: WHEN PRINTING THIS DRAWING, MAKE SURE TO ADJUST FOR PROPER SCALING

9.55.1 SCALED DRAWING - 1:1000
MODEL 737-800

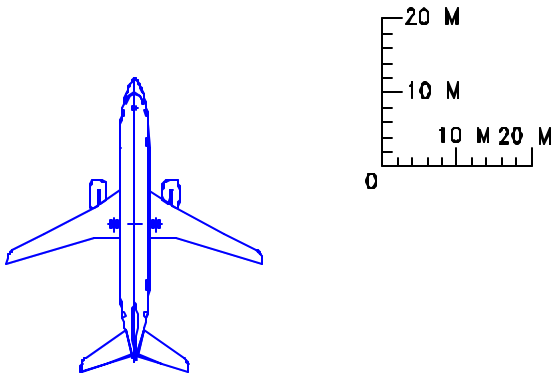

NOTE: WHEN PRINTING THIS DRAWING, MAKE SURE TO ADJUST FOR PROPER SCALING

9.55.2 SCALED DRAWING – 1:1000
MODEL 737-800

D6-58325-6

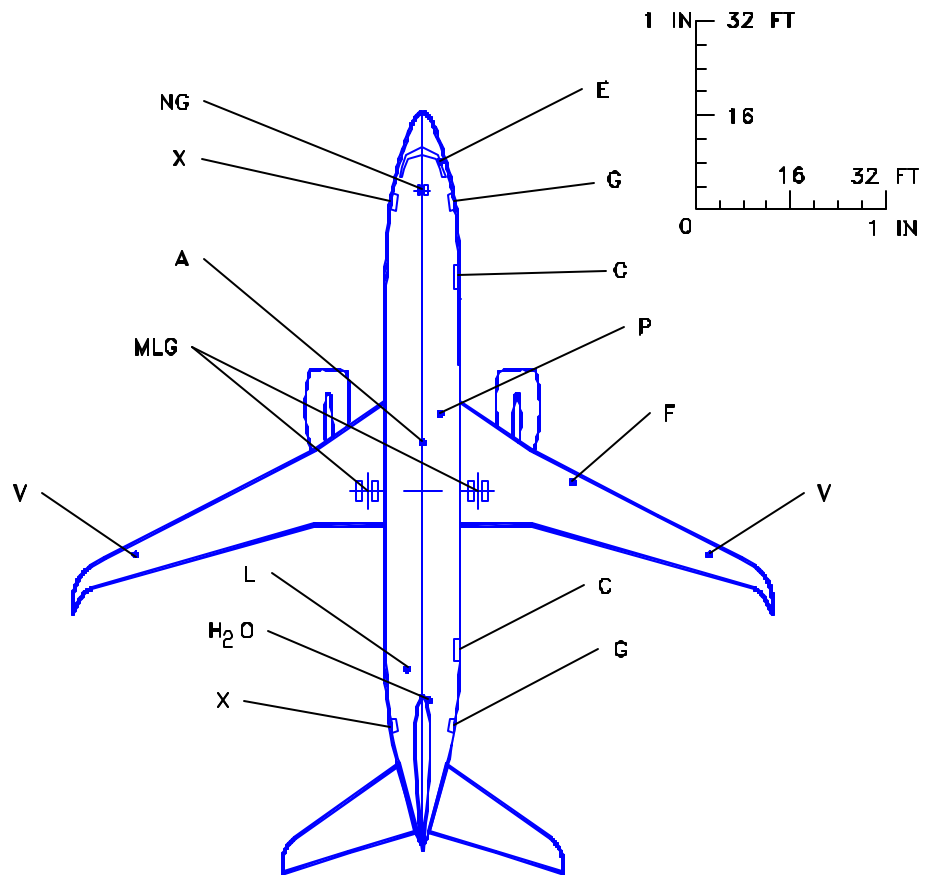

LEGEND

- A AIR CONDITIONING
- C CARGO DOOR
- E ELECTRICAL
- F FUEL
- G SERVICE DOOR
- H₂O POTABLE WATER
- MLG MAIN LANDING GEAR
- NG NOSE LANDING GEAR
- P PNEUMATIC (AIR START)
- L VACUUM LAVATORY SERVICE
- V FUEL VENT
- X PASSENGER DOOR

NOTE: FOR TURNING RADIUS DATA
SEE SECTIONS 4.2 AND 4.3

NOTE: WHEN PRINTING THIS DRAWING, MAKE SURE TO ADJUST FOR PROPER SCALING

9.56.1 SCALED DRAWING - 1 IN = 32 FT
MODEL 737-800 WITH WINGLETS, 737 BBJ2

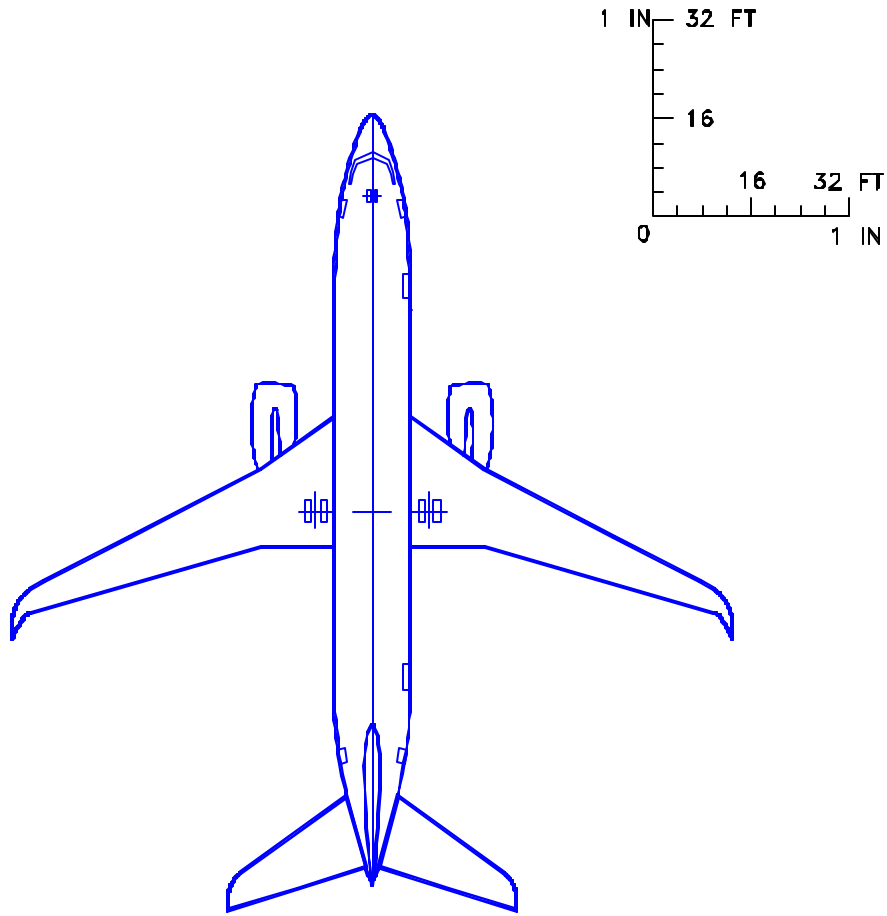

NOTE: WHEN PRINTING THIS DRAWING, MAKE SURE TO ADJUST FOR PROPER SCALING

9.56.2 SCALED DRAWING - 1 IN = 32 FT
MODEL 737-800 WITH WINGLETS, 737 BBJ2

D6-58325-6

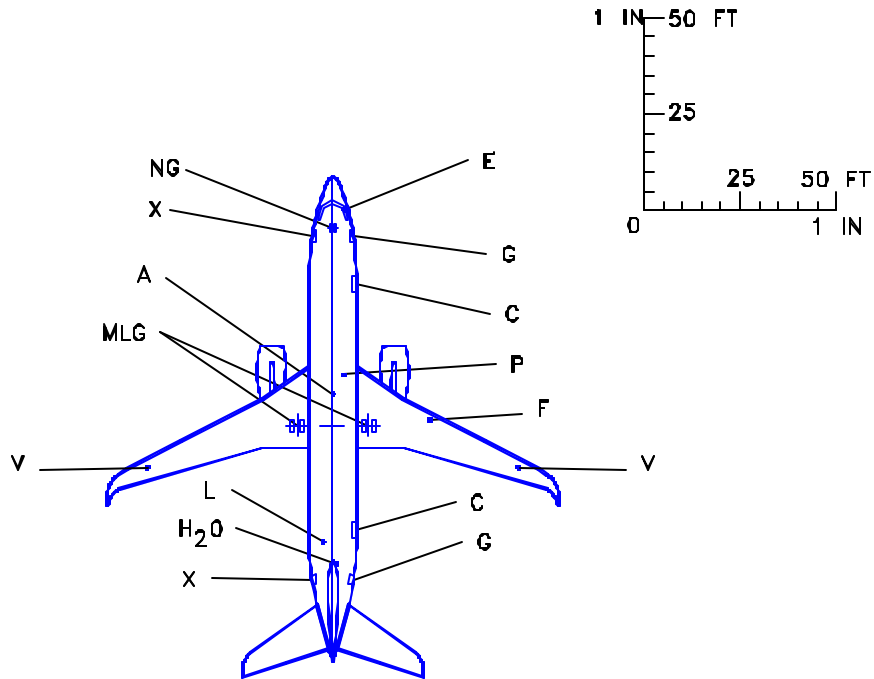

LEGEND

- A AIR CONDITIONING
- C CARGO DOOR
- E ELECTRICAL
- F FUEL
- G SERVICE DOOR
- H₂O POTABLE WATER
- MLG MAIN LANDING GEAR
- NG NOSE LANDING GEAR
- P PNEUMATIC (AIR START)
- L VACUUM LAVATORY SERVICE
- V FUEL VENT
- X PASSENGER DOOR

NOTE: FOR TURNING RADIUS DATA
SEE SECTIONS 4.2 AND 4.3

NOTE: WHEN PRINTING THIS DRAWING, MAKE SURE TO ADJUST FOR PROPER SCALING

9.57.1 SCALED DRAWING - 1 IN = 50 FT
MODEL 737-800 WITH WINGLETS, 737 BBJ2

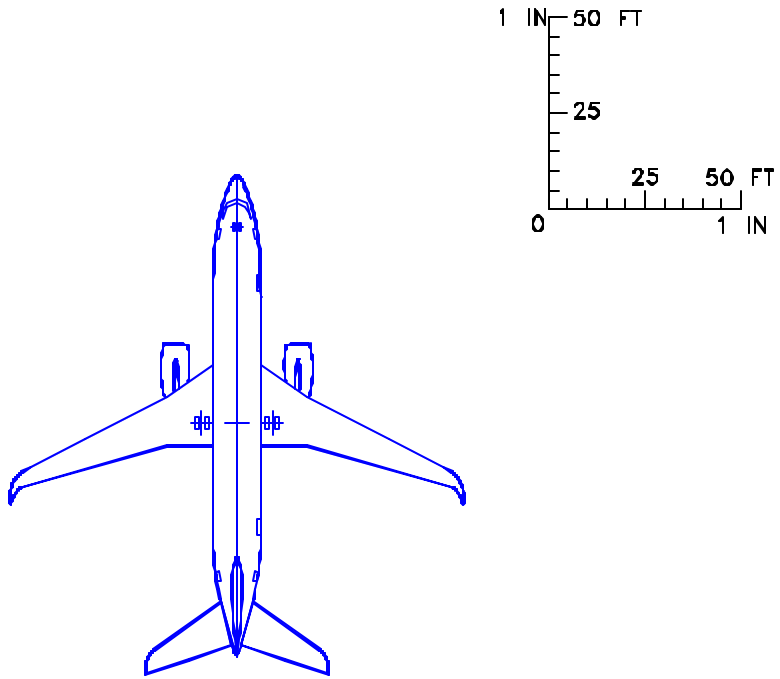

NOTE: WHEN PRINTING THIS DRAWING, MAKE SURE TO ADJUST FOR PROPER SCALING

9.57.2 SCALED DRAWING - 1 IN = 50 FT
MODEL 737-800 WITH WINGLETS, 737 BBJ2

D6-58325-6

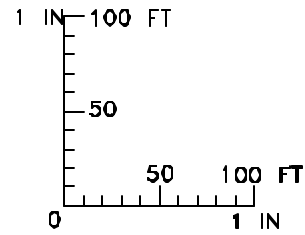
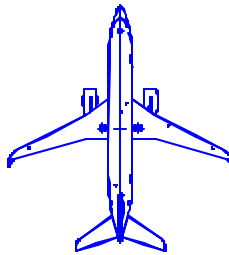

NOTE:

SEE CORRESPONDING PAGE FOR 1 IN = 32 FT
FOR IDENTIFICATIONS OF SERVICE POINTS

LEGEND

A AIR CONDITIONING
C CARGO DOOR
E ELECTRICAL
F FUEL
G SERVICE DOOR
H₂O POTABLE WATER
MLG MAIN LANDING GEAR
NG NOSE LANDING GEAR
P PNEUMATIC (AIR START)
L VACUUM LAVATORY SERVICE
V FUEL VENT
X PASSENGER DOOR

NOTE: FOR TURNING RADIUS DATA
SEE SECTIONS 4.2 AND 4.3

NOTE: WHEN PRINTING THIS DRAWING, MAKE SURE TO ADJUST FOR PROPER SCALING

9.58.1 SCALED DRAWING - 1 IN = 100 FT
MODEL 737-800 WITH WINGLETS, 737 BBJ2

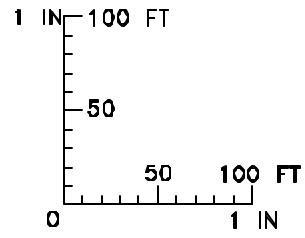
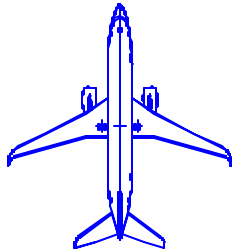

NOTE: WHEN PRINTING THIS DRAWING, MAKE SURE TO ADJUST FOR PROPER SCALING

9.58.2 SCALED DRAWING - 1 IN = 100 FT
MODEL 737-800 WITH WINGLETS, 737 BBJ2

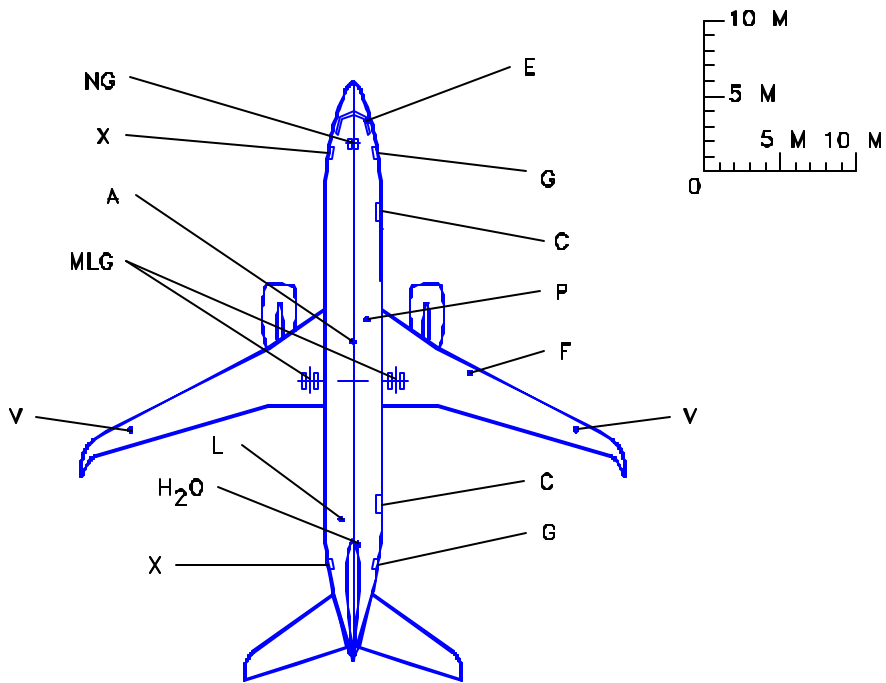

LEGEND

- A AIR CONDITIONING
 - C CARGO DOOR
 - E ELECTRICAL
 - F FUEL
 - G SERVICE DOOR
 - H₂O POTABLE WATER
 - MLG MAIN LANDING GEAR
 - NG NOSE LANDING GEAR
 - P PNEUMATIC (AIR START)
 - L VACUUM LAVATORY SERVICE
 - V FUEL VENT
 - X PASSENGER DOOR
- NOTE: FOR TURNING RADIUS DATA
SEE SECTIONS 4.2 AND 4.3

NOTE: WHEN PRINTING THIS DRAWING, MAKE SURE TO ADJUST FOR PROPER SCALING

9.59.1 SCALED DRAWING - 1:500
MODEL 737-800 WITH WINGLETS, 737 BBJ2

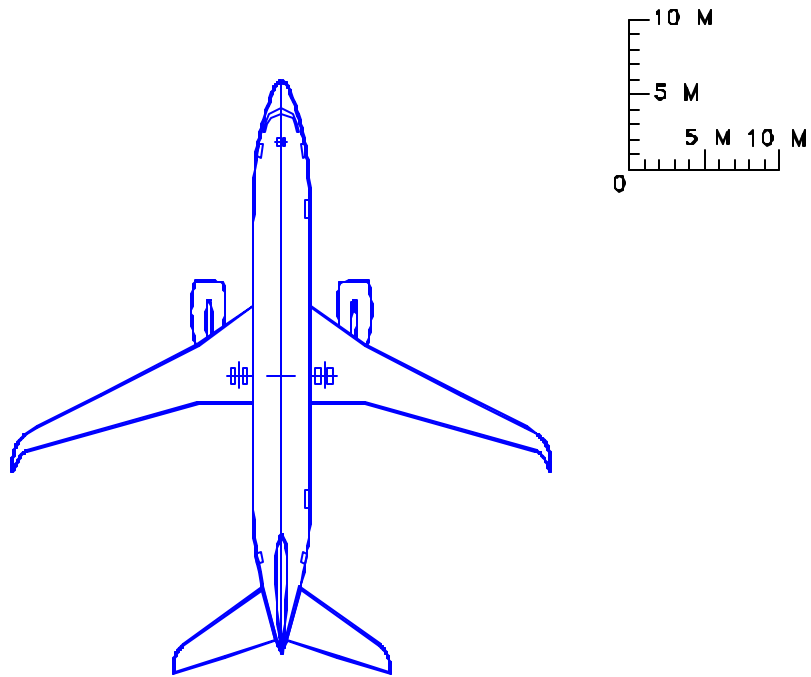

NOTE: WHEN PRINTING THIS DRAWING, MAKE SURE TO ADJUST FOR PROPER SCALING

9.59.2 SCALED DRAWING - 1:500
MODEL 737-800 WITH WINGLETS, 737 BBJ2

D6-58325-6

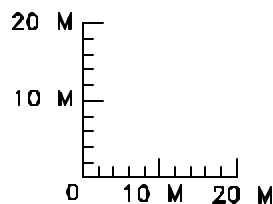
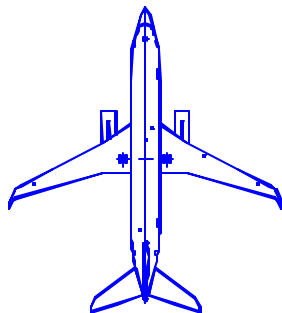

NOTE:

SEE CORRESPONDING PAGE FOR 1 IN = 32 FT
FOR IDENTIFICATIONS OF SERVICE POINTS

LEGEND

A AIR CONDITIONING
C CARGO DOOR
E ELECTRICAL
F FUEL
G SERVICE DOOR
H₂O POTABLE WATER
MLG MAIN LANDING GEAR
NG NOSE LANDING GEAR
P PNEUMATIC (AIR START)
L VACUUM LAVATORY SERVICE
V FUEL VENT
X PASSENGER DOOR

NOTE: FOR TURNING RADIUS DATA
SEE SECTIONS 4.2 AND 4.3

NOTE: WHEN PRINTING THIS DRAWING, MAKE SURE TO ADJUST FOR PROPER SCALING

9.60.1 SCALED DRAWING - 1:1000
MODEL 737-800 WITH WINGLETS, 737 BBJ2

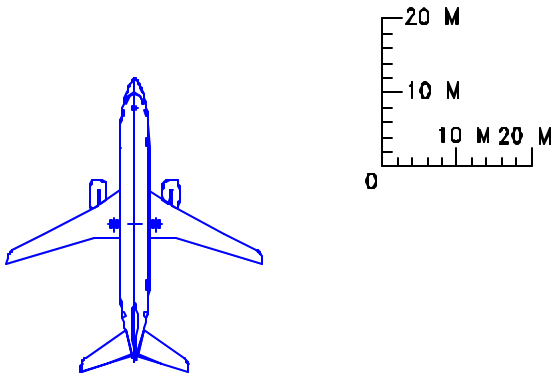

NOTE: WHEN PRINTING THIS DRAWING, MAKE SURE TO ADJUST FOR PROPER SCALING

9.60.2 SCALED DRAWING – 1:1000
MODEL 737-800 WITH WINGLETS, 737 BBJ2

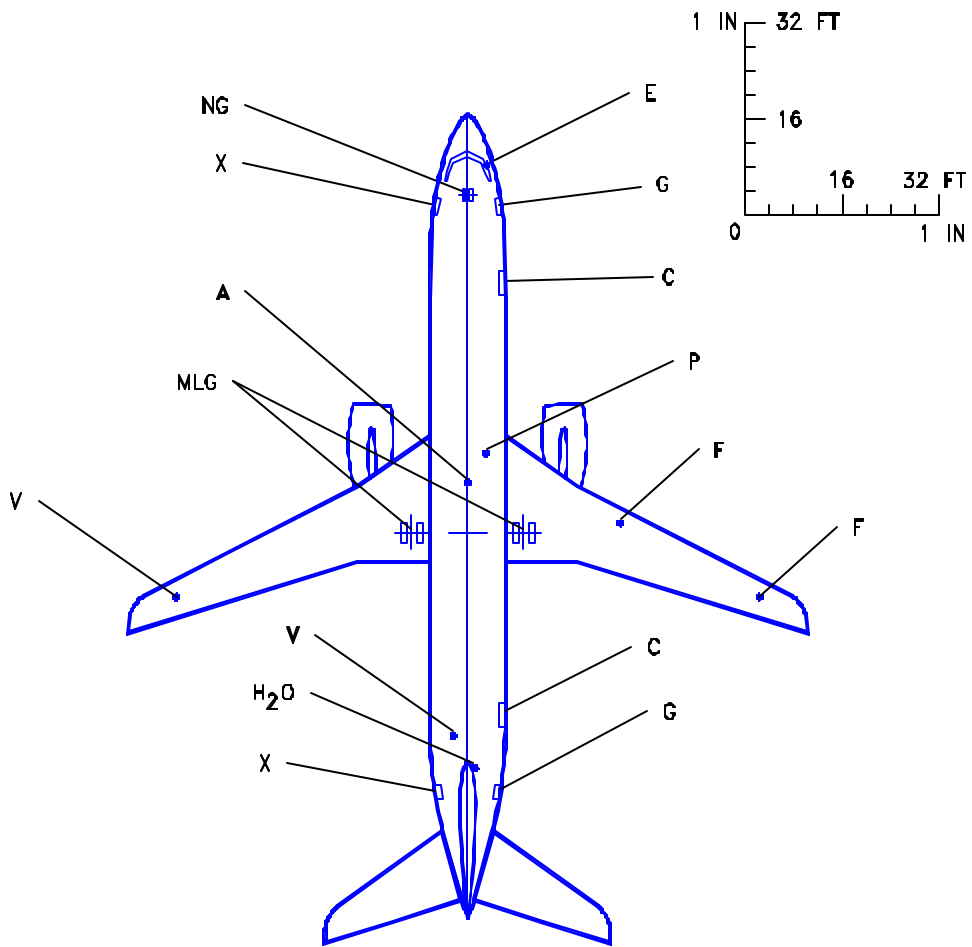

LEGEND

- A AIR CONDITIONING
- C CARGO DOOR
- E ELECTRICAL
- F FUEL
- G SERVICE DOOR
- H₂O POTABLE WATER
- MLG MAIN LANDING GEAR
- NG NOSE LANDING GEAR
- P PNEUMATIC (AIR START)
- L VACUUM LAVATORY SERVICE
- V FUEL VENT
- X PASSENGER DOOR

NOTE: FOR TURNING RADIUS DATA
SEE SECTIONS 4.2 AND 4.3

NOTE: WHEN PRINTING THIS DRAWING, MAKE SURE TO ADJUST FOR PROPER SCALING

9.61.1 SCALED DRAWING - 1 IN = 32 FT
MODEL 737-900, -900ER

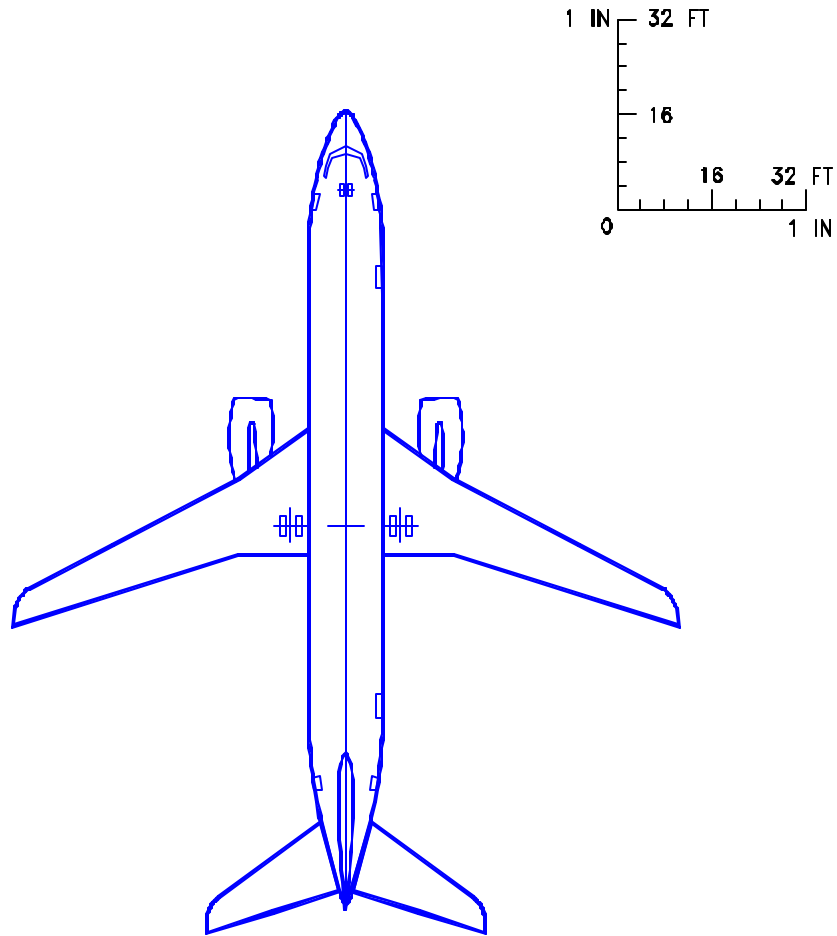

NOTE: WHEN PRINTING THIS DRAWING, MAKE SURE TO ADJUST FOR PROPER SCALING

9.61.2 SCALED DRAWING - 1 IN = 32 FT
MODEL 737-900, -900ER

D6-58325-6

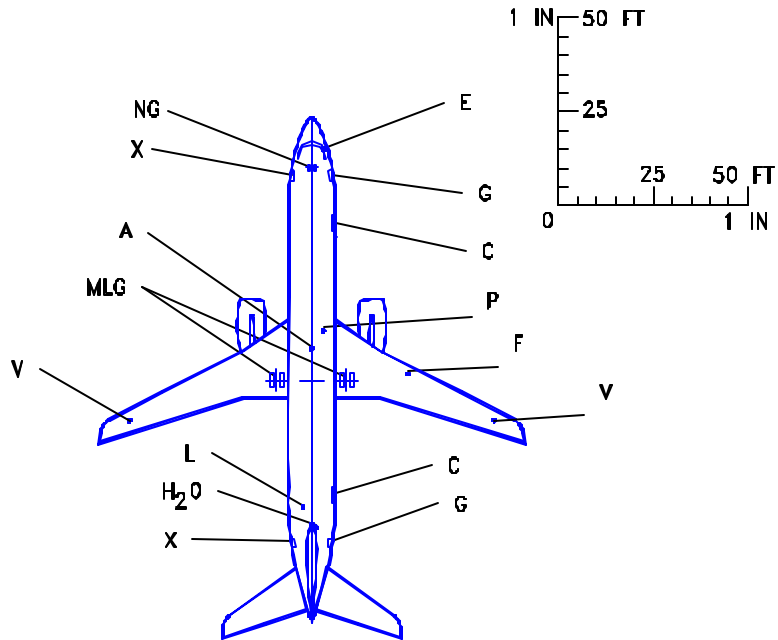

LEGEND

- A AIR CONDITIONING
- C CARGO DOOR
- E ELECTRICAL
- F FUEL
- G SERVICE DOOR
- H₂O POTABLE WATER
- MLG MAIN LANDING GEAR
- NG NOSE LANDING GEAR
- P PNEUMATIC (AIR START)
- L VACUUM LAVATORY SERVICE
- V FUEL VENT
- X PASSENGER DOOR

NOTE: FOR TURNING RADIUS DATA
SEE SECTIONS 4.2 AND 4.3

NOTE: WHEN PRINTING THIS DRAWING, MAKE SURE TO ADJUST FOR PROPER SCALING

9.62.1 SCALED DRAWING - 1 IN = 50 FT
MODEL 737-900, -900ER

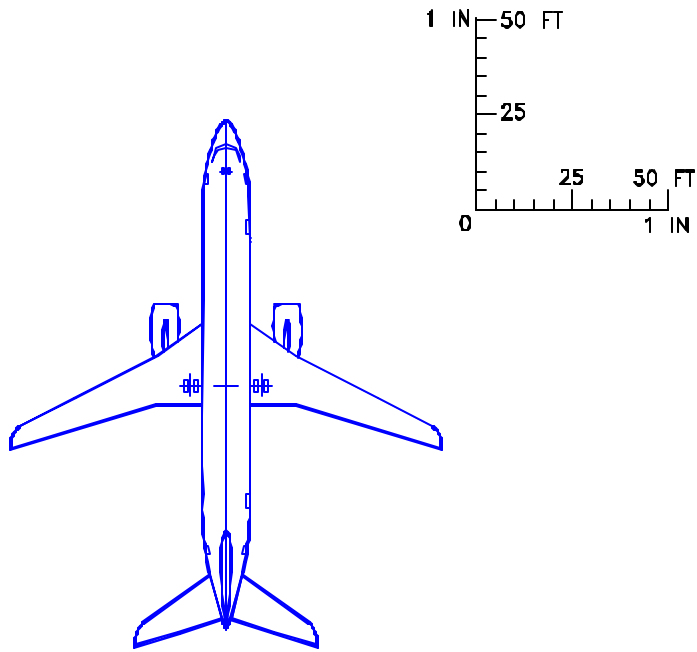

NOTE: WHEN PRINTING THIS DRAWING, MAKE SURE TO ADJUST FOR PROPER SCALING

9.62.2 SCALED DRAWING - 1 IN = 50 FT
MODEL 737-900, -900ER

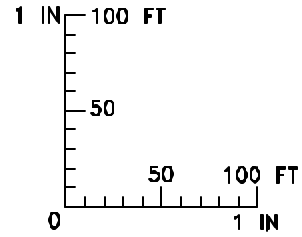
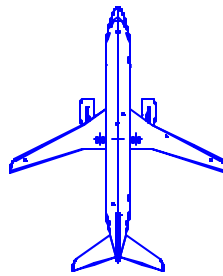

NOTE:

SEE CORRESPONDING PAGE FOR 1 IN = 32 FT
FOR IDENTIFICATIONS OF SERVICE POINTS

LEGEND

A AIR CONDITIONING
C CARGO DOOR
E ELECTRICAL
F FUEL
G SERVICE DOOR
H₂O POTABLE WATER
MLG MAIN LANDING GEAR
NG NOSE LANDING GEAR
P PNEUMATIC (AIR START)
L VACUUM LAVATORY SERVICE
V FUEL VENT
X PASSENGER DOOR

NOTE: FOR TURNING RADIUS DATA
SEE SECTIONS 4.2 AND 4.3

NOTE: WHEN PRINTING THIS DRAWING, MAKE SURE TO ADJUST FOR PROPER SCALING

9.63.1 SCALED DRAWING - 1 IN = 100 FT
MODEL 737-900, -900ER

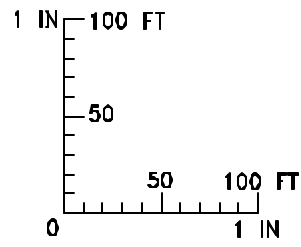
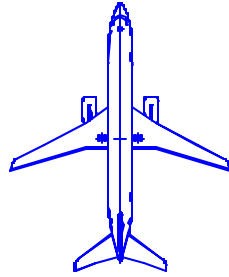

NOTE: WHEN PRINTING THIS DRAWING, MAKE SURE TO ADJUST FOR PROPER SCALING

9.63.2 SCALED DRAWING - 1 IN = 100 FT
MODEL 737-900, -900ER

D6-58325-6

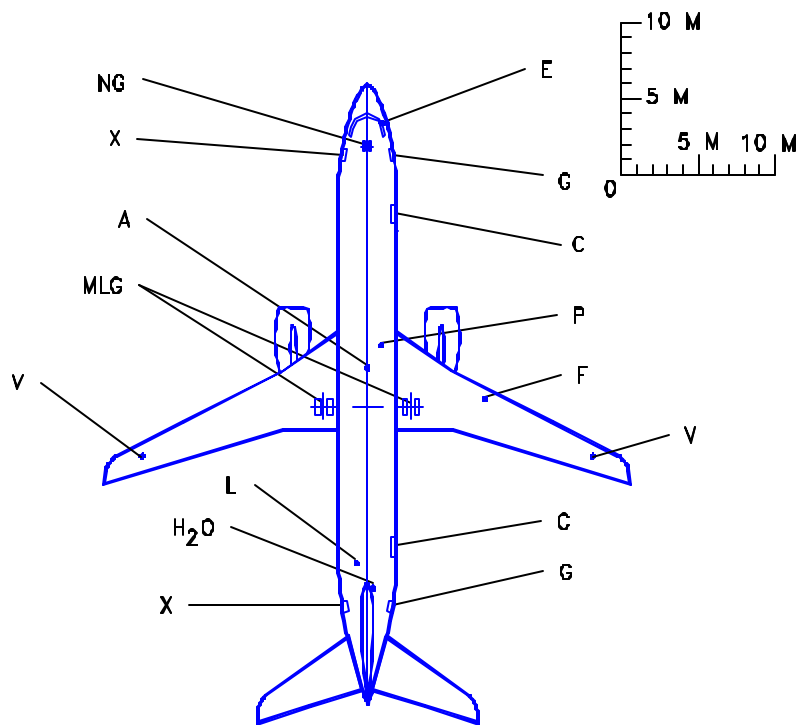

LEGEND

- A AIR CONDITIONING
- C CARGO DOOR
- E ELECTRICAL
- F FUEL
- G SERVICE DOOR
- H₂O POTABLE WATER
- MLG MAIN LANDING GEAR
- NG NOSE LANDING GEAR
- P PNEUMATIC (AIR START)
- L VACUUM LAVATORY SERVICE
- V FUEL VENT
- X PASSENGER DOOR

NOTE: FOR TURNING RADIUS DATA
SEE SECTIONS 4.2 AND 4.3

NOTE: WHEN PRINTING THIS DRAWING, MAKE SURE TO ADJUST FOR PROPER SCALING

9.64.1 SCALED DRAWING - 1:500
MODEL 737-900, -900ER

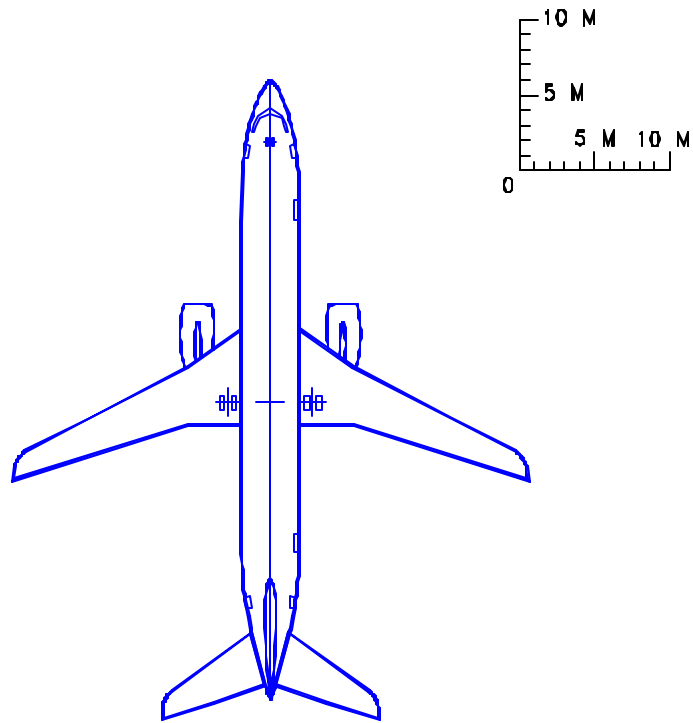

NOTE: WHEN PRINTING THIS DRAWING, MAKE SURE TO ADJUST FOR PROPER SCALING

9.64.2 SCALED DRAWING - 1:500
MODEL 737-900, -900ER

D6-58325-6

670 OCTOBER 2005

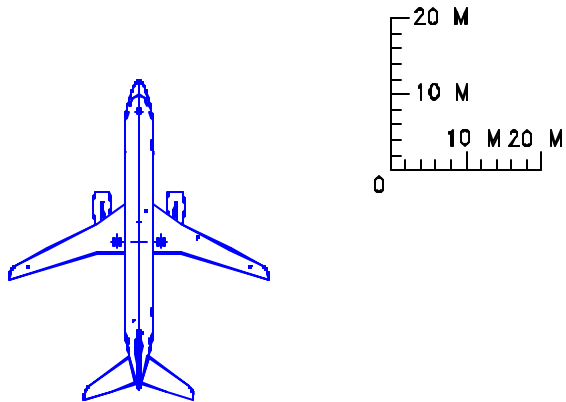

NOTE:

SEE CORRESPONDING PAGE FOR 1 IN = 32 FT
FOR IDENTIFICATIONS OF SERVICE POINTS

LEGEND

A	AIR CONDITIONING
C	CARGO DOOR
E	ELECTRICAL
F	FUEL
G	SERVICE DOOR
H ₂ O	POTABLE WATER
MLG	MAIN LANDING GEAR
NG	NOSE LANDING GEAR
P	PNEUMATIC (AIR START)
L	VACUUM LAVATORY SERVICE
V	FUEL VENT
X	PASSENGER DOOR

NOTE: FOR TURNING RADIUS DATA
SEE SECTIONS 4.2 AND 4.3

NOTE: WHEN PRINTING THIS DRAWING, MAKE SURE TO ADJUST FOR PROPER SCALING

9.65.1 SCALED DRAWING - 1:1000
MODEL 737-900, -900ER

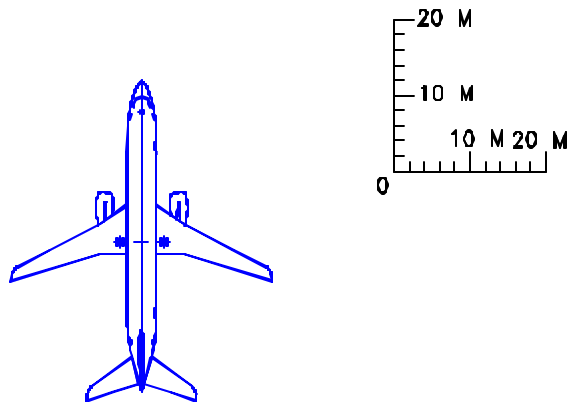

NOTE: WHEN PRINTING THIS DRAWING, MAKE SURE TO ADJUST FOR PROPER SCALING

9.65.2 SCALED DRAWING – 1:1000
MODEL 737-900, -900ER

D6-58325-6

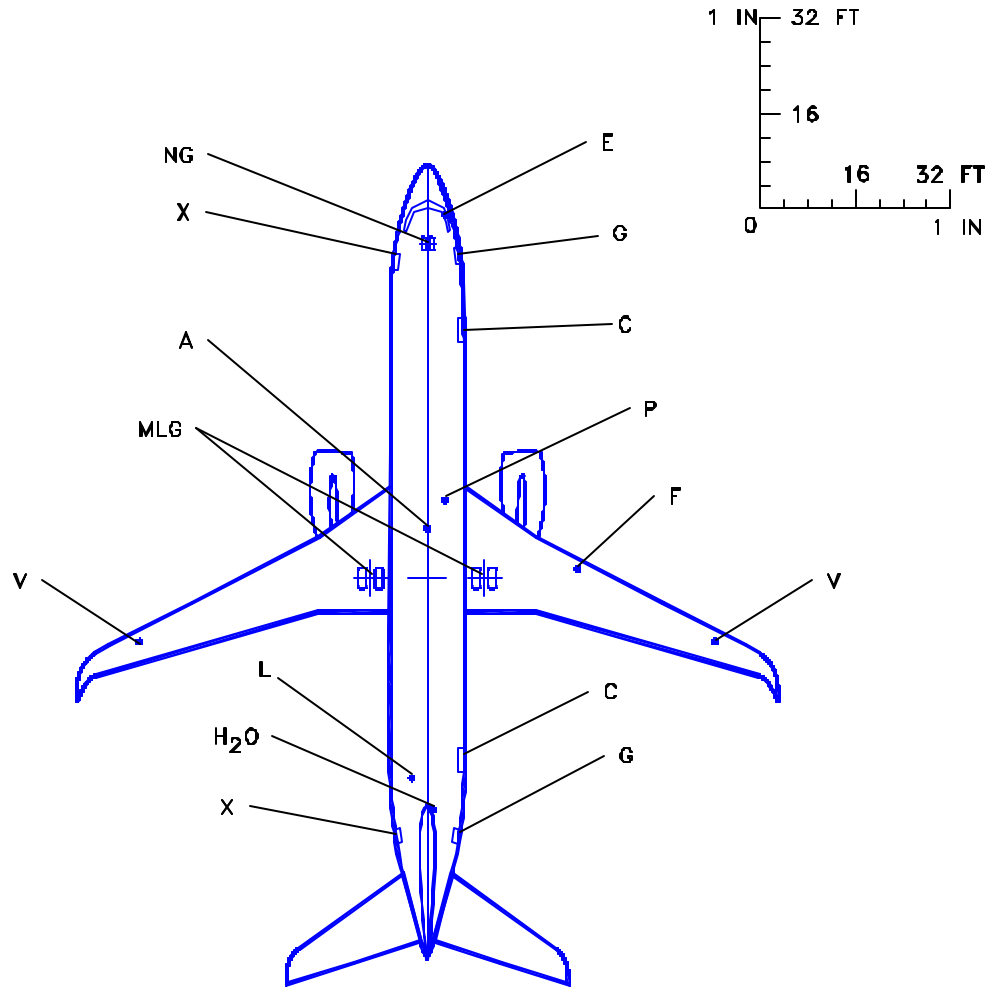

LEGEND

- A AIR CONDITIONING
- C CARGO DOOR
- E ELECTRICAL
- F FUEL
- G SERVICE DOOR
- H₂O POTABLE WATER
- MLG MAIN LANDING GEAR
- NG NOSE LANDING GEAR
- P PNEUMATIC (AIR START)
- L VACUUM LAVATORY SERVICE
- V FUEL VENT
- X PASSENGER DOOR

NOTE: FOR TURNING RADIUS DATA
SEE SECTIONS 4.2 AND 4.3

NOTE: WHEN PRINTING THIS DRAWING, MAKE SURE TO ADJUST FOR PROPER SCALING

9.66.1 SCALED DRAWING - 1 IN = 32 FT
MODEL 737-900, -900ER WITH WINGLETS

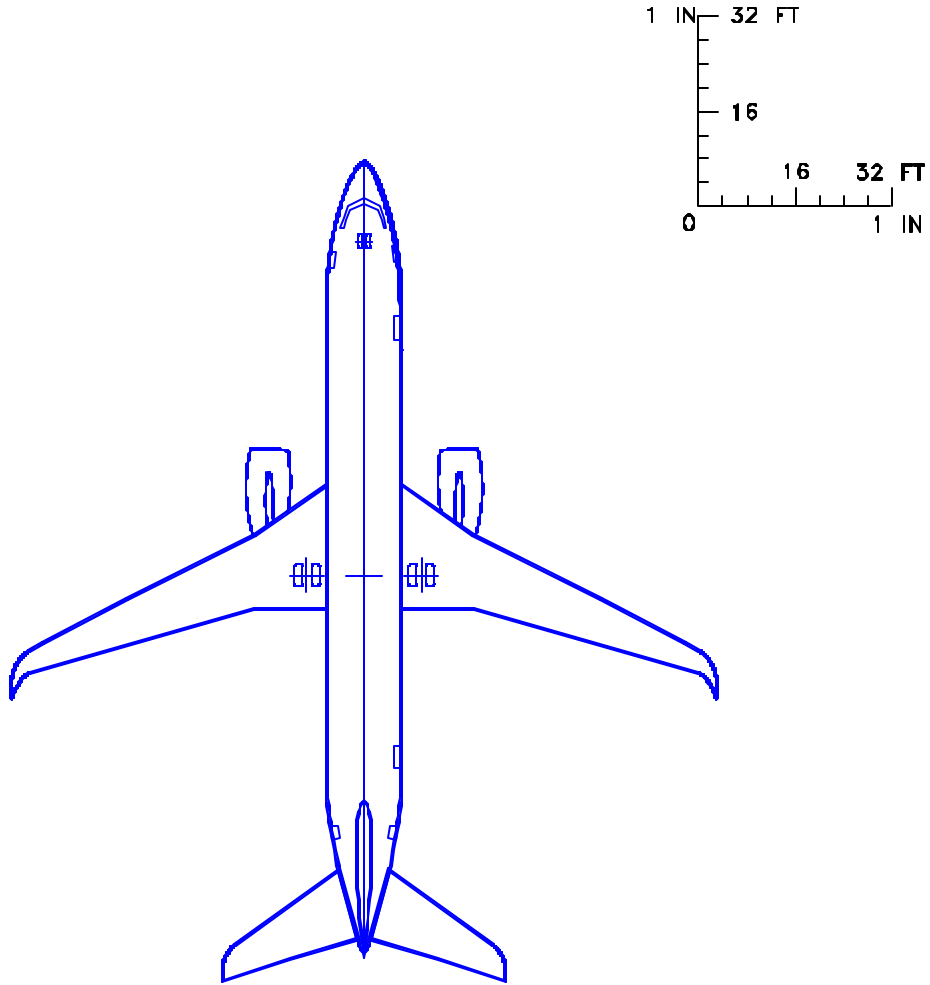

NOTE: WHEN PRINTING THIS DRAWING, MAKE SURE TO ADJUST FOR PROPER SCALING

9.66.2 SCALED DRAWING - 1 IN = 32 FT
MODEL 737-900, -900ER WITH WINGLETS

D6-58325-6

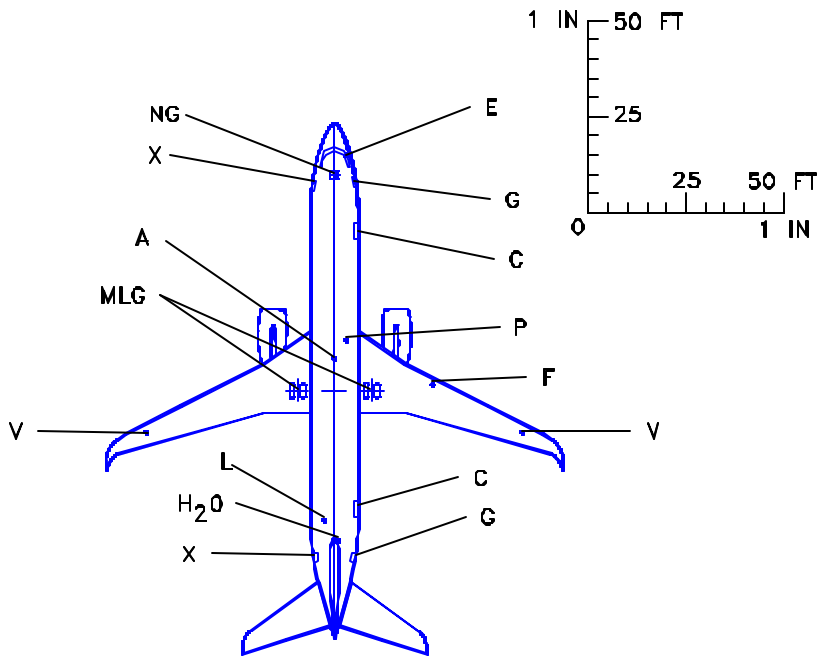

LEGEND

- A AIR CONDITIONING
- C CARGO DOOR
- E ELECTRICAL
- F FUEL
- G SERVICE DOOR
- H₂O POTABLE WATER
- MLG MAIN LANDING GEAR
- NG NOSE LANDING GEAR
- P PNEUMATIC (AIR START)
- L VACUUM LAVATORY SERVICE
- V FUEL VENT
- X PASSENGER DOOR

NOTE: FOR TURNING RADIUS DATA
SEE SECTIONS 4.2 AND 4.3

NOTE: WHEN PRINTING THIS DRAWING, MAKE SURE TO ADJUST FOR PROPER SCALING

9.67.1 SCALED DRAWING - 1 IN = 50 FT
MODEL 737-900, -900ER WITH WINGLETS

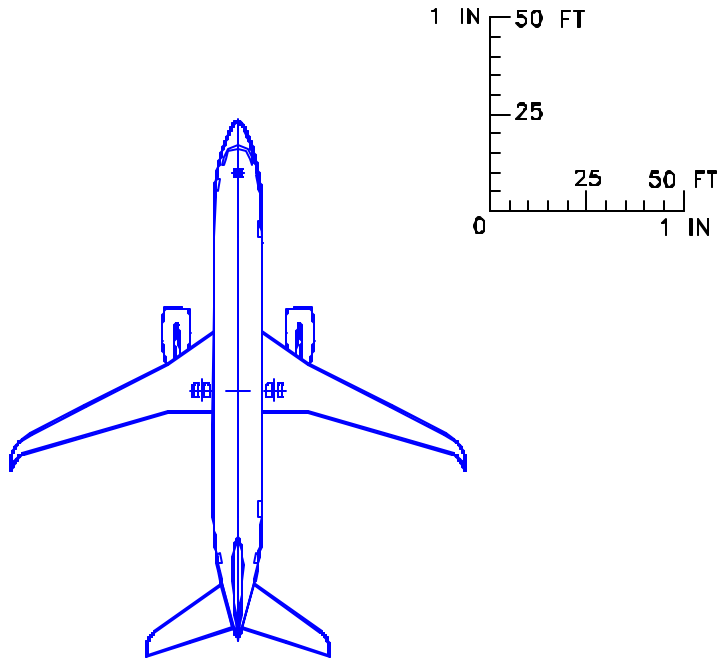

NOTE: WHEN PRINTING THIS DRAWING, MAKE SURE TO ADJUST FOR PROPER SCALING

9.67.2 SCALED DRAWING - 1 IN = 50 FT
MODEL 737-900, -900ER WITH WINGLETS

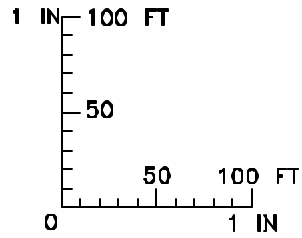
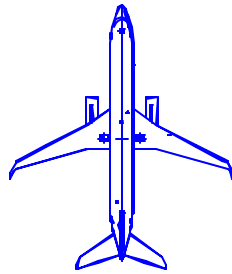

NOTE:
SEE CORRESPONDING PAGE FOR 1 IN = 32 FT
FOR IDENTIFICATIONS OF SERVICE POINTS

LEGEND

- A AIR CONDITIONING
- C CARGO DOOR
- E ELECTRICAL
- F FUEL
- G SERVICE DOOR
- H₂O POTABLE WATER
- MLG MAIN LANDING GEAR
- NG NOSE LANDING GEAR
- P PNEUMATIC (AIR START)
- L VACUUM LAVATORY SERVICE
- V FUEL VENT
- X PASSENGER DOOR

NOTE: FOR TURNING RADIUS DATA
SEE SECTIONS 4.2 AND 4.3

NOTE: WHEN PRINTING THIS DRAWING, MAKE SURE TO ADJUST FOR PROPER SCALING

9.68.1 SCALED DRAWING - 1 IN = 100 FT
MODEL 737-900, -900ER WITH WINGLETS

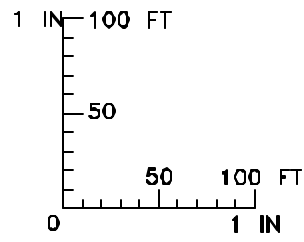
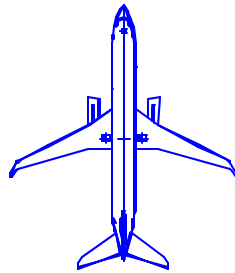

NOTE: WHEN PRINTING THIS DRAWING, MAKE SURE TO ADJUST FOR PROPER SCALING

9.68.2 SCALED DRAWING - 1 IN = 100 FT
MODEL 737-900, -900ER WITH WINGLETS

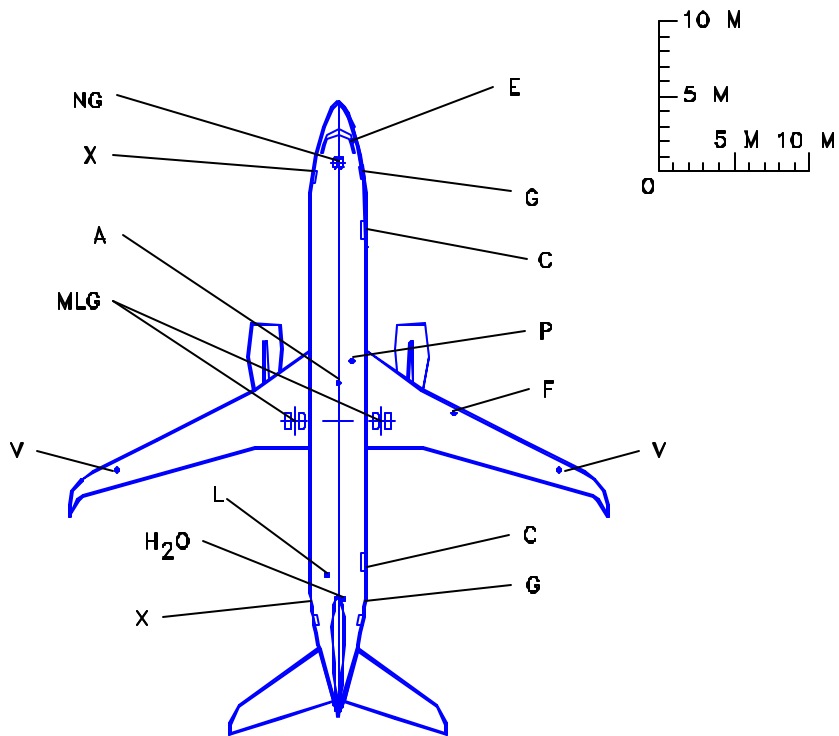

LEGEND

- A AIR CONDITIONING
- C CARGO DOOR
- E ELECTRICAL
- F FUEL
- G SERVICE DOOR
- H₂O POTABLE WATER
- MLG MAIN LANDING GEAR
- NG NOSE LANDING GEAR
- P PNEUMATIC (AIR START)
- L VACUUM LAVATORY SERVICE
- V FUEL VENT
- X PASSENGER DOOR

NOTE: FOR TURNING RADIUS DATA
SEE SECTIONS 4.2 AND 4.3

NOTE: WHEN PRINTING THIS DRAWING, MAKE SURE TO ADJUST FOR PROPER SCALING

9.69.1 SCALED DRAWING - 1:500
MODEL 737-900, -900ER WITH WINGLETS

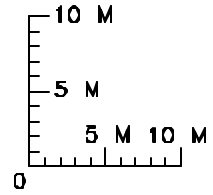
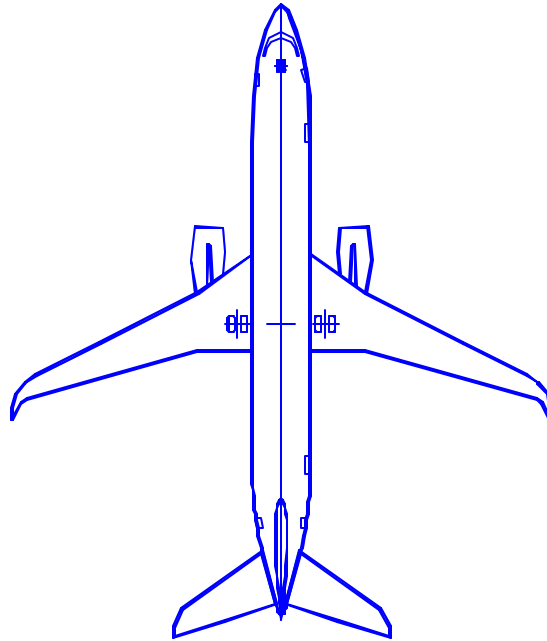

NOTE: WHEN PRINTING THIS DRAWING, MAKE SURE TO ADJUST FOR PROPER SCALING

9.69.2 SCALED DRAWING - 1:500
MODEL 737-900, -900ER WITH WINGLETS

D6-58325-6

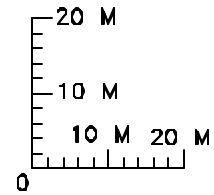
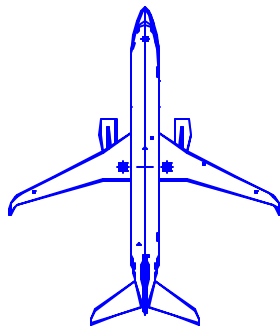

NOTE:

SEE CORRESPONDING PAGE FOR 1 IN = 32 FT
FOR IDENTIFICATIONS OF SERVICE POINTS

LEGEND

A	AIR CONDITIONING
C	CARGO DOOR
E	ELECTRICAL
F	FUEL
G	SERVICE DOOR
H ₂ O	POTABLE WATER
MLG	MAIN LANDING GEAR
NG	NOSE LANDING GEAR
P	PNEUMATIC (AIR START)
L	VACUUM LAVATORY SERVICE
V	FUEL VENT
X	PASSENGER DOOR

NOTE: FOR TURNING RADIUS DATA
SEE SECTIONS 4.2 AND 4.3

NOTE: WHEN PRINTING THIS DRAWING, MAKE SURE TO ADJUST FOR PROPER SCALING

9.70.1 SCALED DRAWING - 1:1000

MODEL 737-900, -900ER WITH WINGLETS

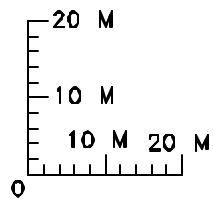
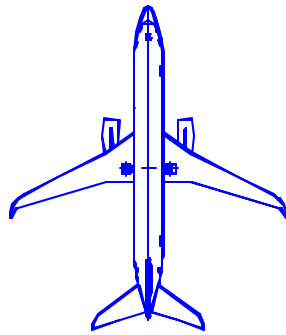

NOTE: WHEN PRINTING THIS DRAWING, MAKE SURE TO ADJUST FOR PROPER SCALING

9.70.2 SCALED DRAWING – 1:1000
MODEL 737-900, -900ER WITH WINGLETS